

RFID System

V680 Series

Hand-held Reader Writer
User's Manual

Hand-held Reader Writer

V680-CHUD

V680-CH1D

V680-CH1D-PSI

ID Tags

V680/V680S Series

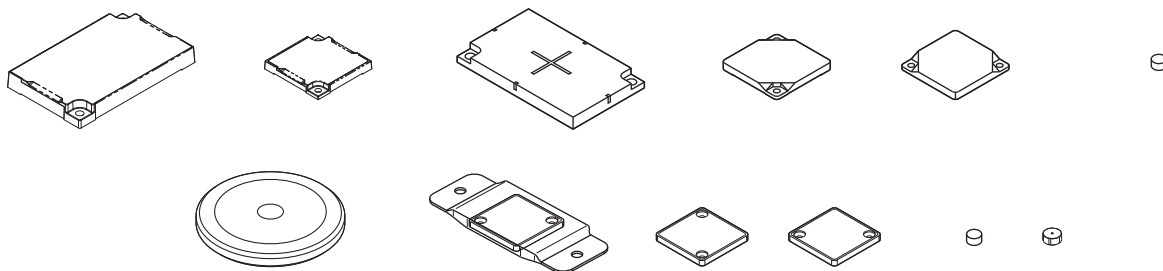
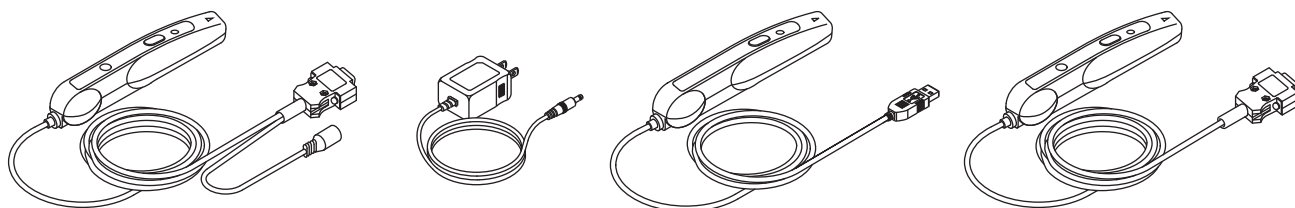

Introduction

Thank you for purchasing a V680/V680S-series RFID System. This manual describes the functions, performance, and application methods needed for optimum use of the V680/V680S-series RFID System.

Please observe the following items when using the V680-series RFID System.

- Allow the V680/V680S-series RFID System to be installed and operated only by qualified specialist with a sufficient knowledge of electrical systems.
- Read and understand this manual before attempting to use the V680/V680S-series RFID System and use the V680/V680S-series RFID System correctly.
- Keep this manual in a safe and accessible location so that it is available for reference when required.

Introduction	READ AND UNDERSTAND THIS DOCUMENT	Introduction
Section 1	Product Overview	Section 1
Section 2	Communications Preparations	Section 2
Section 3	Commands	Section 3
Section 4	Functions	Section 4
Section 5	Troubleshooting	Section 5
Section 6	Appendices	Section 6

RFID System

V680-CHUD	Hand-held Reader/Writer
V680-CH1D	Hand-held Reader/Writer
V680-CH1D-PSI	Hand-held Reader/Writer
V680 Series	RF Tags
V680S Series	RF Tags

User's Manual

READ AND UNDERSTAND THIS DOCUMENT

Please read and understand this document before using the products. Please consult your OMRON representative if you have any questions or comments.

WARRANTY

OMRON's exclusive warranty is that the products are free from defects in materials and workmanship for a period of one year (or other period if specified) from date of sale by OMRON.

OMRON MAKES NO WARRANTY OR REPRESENTATION, EXPRESS OR IMPLIED, REGARDING NON-INFRINGEMENT, MERCHANTABILITY, OR FITNESS FOR PARTICULAR PURPOSE OF THE PRODUCTS. ANY BUYER OR USER ACKNOWLEDGES THAT THE BUYER OR USER ALONE HAS DETERMINED THAT THE PRODUCTS WILL SUITABLY MEET THE REQUIREMENTS OF THEIR INTENDED USE. OMRON DISCLAIMS ALL OTHER WARRANTIES, EXPRESS OR IMPLIED.

LIMITATIONS OF LIABILITY

OMRON SHALL NOT BE RESPONSIBLE FOR SPECIAL, INDIRECT, OR CONSEQUENTIAL DAMAGES, LOSS OF PROFITS OR COMMERCIAL LOSS IN ANY WAY CONNECTED WITH THE PRODUCTS, WHETHER SUCH CLAIM IS BASED ON CONTRACT, WARRANTY, NEGLIGENCE, OR STRICT LIABILITY.

In no event shall responsibility of OMRON for any act exceed the individual price of the product on which liability is asserted.

IN NO EVENT SHALL OMRON BE RESPONSIBLE FOR WARRANTY, REPAIR, OR OTHER CLAIMS REGARDING THE PRODUCTS UNLESS OMRON'S ANALYSIS CONFIRMS THAT THE PRODUCTS WERE PROPERLY HANDLED, STORED, INSTALLED, AND MAINTAINED AND NOT SUBJECT TO CONTAMINATION, ABUSE, MISUSE, OR INAPPROPRIATE MODIFICATION OR REPAIR.

SUITABILITY FOR USE

THE PRODUCTS CONTAINED IN THIS DOCUMENT ARE NOT SAFETY RATED. THEY ARE NOT DESIGNED OR RATED FOR ENSURING SAFETY OF PERSONS, AND SHOULD NOT BE RELIED UPON AS A SAFETY COMPONENT OR PROTECTIVE DEVICE FOR SUCH PURPOSES. Please refer to separate catalogs for OMRON's safety rated products.

OMRON shall not be responsible for conformity with any standards, codes, or regulations that apply to the combination of products in the customer's application or use of the product.

At the customer's request, OMRON will provide applicable third party certification documents identifying ratings and limitations of use that apply to the products. This information by itself is not sufficient for a complete determination of the suitability of the products in combination with the end product, machine, system, or other application or use.

The following are some examples of applications for which particular attention must be given. This is not intended to be an exhaustive list of all possible uses of the products, nor is it intended to imply that the uses listed may be suitable for the products:

- Outdoor use, uses involving potential chemical contamination or electrical interference, or conditions or uses not described in this document.
- Nuclear energy control systems, combustion systems, railroad systems, aviation systems, medical equipment, amusement machines, vehicles, safety equipment, and installations subject to separate industry or government regulations.
- Systems, machines, and equipment that could present a risk to life or property.

Please know and observe all prohibitions of use applicable to the products.

NEVER USE THE PRODUCTS FOR AN APPLICATION INVOLVING SERIOUS RISK TO LIFE OR PROPERTY WITHOUT ENSURING THAT THE SYSTEM AS A WHOLE HAS BEEN DESIGNED TO ADDRESS THE RISKS, AND THAT THE OMRON PRODUCT IS PROPERLY RATED AND INSTALLED FOR THE INTENDED USE WITHIN THE OVERALL EQUIPMENT OR SYSTEM.

PERFORMANCE DATA

Performance data given in this document is provided as a guide for the user in determining suitability and does not constitute a warranty. It may represent the result of OMRON's test conditions, and the users must correlate it to actual application requirements. Actual performance is subject to the OMRON Warranty and Limitations of Liability.

CHANGE IN SPECIFICATIONS

Product specifications and accessories may be changed at any time based on improvements and other reasons.

It is our practice to change model numbers when published ratings or features are changed, or when significant construction changes are made. However, some specifications of the product may be changed without any notice. When in doubt, special model numbers may be assigned to fix or establish key specifications for your application on your request. Please consult with your OMRON representative at any time to confirm actual specifications of purchased products.

DIMENSIONS AND WEIGHTS

Dimensions and weights are nominal and are not to be used for manufacturing purposes, even when tolerances are shown.

ERRORS AND OMISSIONS

The information in this document has been carefully checked and is believed to be accurate; however, no responsibility is assumed for clerical, typographical, or proofreading errors, or omissions.

PROGRAMMABLE PRODUCTS

OMRON shall not be responsible for the user's programming of a programmable product, or any consequence thereof.

COPYRIGHT AND COPY PERMISSION

This document shall not be copied for sales or promotions without permission. This document is protected by copyright and is intended solely for use in conjunction with the product. Please notify us before copying or reproducing this document in any manner, for any other purpose. If copying or transmitting this document to another, please copy or transmit it in its entirety.

Safety Precautions

● Signal Words Used in This Manual

The following symbols are used in this manual to indicate precautions that must be observed to ensure safe use of the V680/V680S-series RFID System. The precautions provided here contain important safety information. Be sure to observe these precautions.

The following signal words are used in this manual.



Indicates a potentially hazardous situation which, if not avoided, will result in minor or moderate injury, or may result in serious injury or death. Additionally, there may be significant property damage.

● Meanings of Alert Symbols

	<p>Indicates the possibility of explosion under specific conditions.</p>
	<p>Indicates general prohibitions for which there is no specific symbol.</p>

● Warning



This Product is not designed or rated for ensuring safety of persons. Do not use it for such purposes.



Precautions for Safe Use

Observe the following precautions to ensure safe use of the Product.

1. Do not use the Product in environments with flammable, explosive, or corrosive gasses.
2. Do not attempt to disassemble, repair, or modify the Product.
3. The USB driver must be installed in the personal computer before connecting the V680-CHUD to a personal computer.
4. Do not subject cables to excessive loads.
5. Observe all warnings and precautions given in the body of this manual.
6. Discontinue usage and turn OFF the power supply immediately if you notice any unusual odors, if the Product is abnormally hot, or if the Product starts smoking.
7. Dispose of the Product as industrial waste.

Precautions for Correct Use

Always observe the following precautions to prevent operation failures, malfunctions, and adverse effects on performance and equipment.

1. Installation and Storage Environment

Do not use or store the Product in the following locations.

- Locations exposed to corrosive gases, dust, metallic powder, or salts
- Locations not within the specified operating temperature range
- Locations subject to rapid changes in temperature or condensation
- Locations not within the specified operating humidity range
- Locations subject to direct vibration or shock outside the specified ranges
- Locations subject to spray of water, oil, or chemicals

2. Environment

- This Product uses a frequency band of 13.56 MHz to communicate with RF Tags. Some motors, inverters, switching power supplies, and other devices generate electrical noise that will affect communications with the RF Tags. If any of these devices are located in the vicinity of the Product, they may affect communications with RF Tags, and may possibly damage the RF Tags. Prior to using the Product in the vicinity of any of these devices, perform a test to determine whether the Product can be used under the resulting influence.
- Observe the following precautions to minimize the effects of normal noise.
 - (1) Ground all metal objects in the vicinity of the Product to 100 Ω or less.
 - (2) Do not use the Product near high-voltage or high-current lines.
- Connectors are not waterproof. Do not use the Product where mists are present.
- Do not use chemicals that would affect the materials used in the product.
- Be sure the USB connector is properly inserted when using the USB port on the V680-CHUD.
- Always use the specified AC Adaptor (V600-A22) when using the V680-CH1D.
- The communications range is adversely affected if there is any metal material around the RF Tag.
- Transmission will not be possible if the front and back panels are mistakenly reversed and the Unit is mounted to a metallic surface.
 - V680-D1KP66MT
 - V680-D8KF67M
 - V680S-D2KF67M
 - V680S-D2KF68M
 - V680S-D8KF67M
 - V680S-D8KF68M
- The communications range will be reduced when the Unit is not mounted to a metallic surface.
 - V680-D1KP66MT
 - V680-D8KF67M
 - V680S-D2KF67M
 - V680S-D2KF68M
 - V680S-D8KF67M
 - V680S-D8KF68M
- The maximum communications range can be obtained when the Antenna faces the RF tag directly. When the RF tag is installed at a tilt, the communications range is reduced. Consider the effect of the RF tag at tilt when installing the RF Tag.
- Provide the mounting distances between plural RF tags to prevent them from malfunctions due to mutual interference

- If the central axis of an antenna and RF tag shifts, a communications range will fall.
- Do not touch the product immediately after usage at high temperatures. Doing so may occasionally result in burning.

3. Host Communications

Always confirm that the Product has been started before attempting to communicate with it from the host. Also, when the Product is started, unstable signals may be output from the host interface. When starting operation, clear the reception buffers in the host or take other suitable countermeasures.

4. Cleaning

- Do not clean the product with thinners, benzene, or other organic solvents. These will dissolve the resin parts and coating on the case.

How to Read this Manual

Meanings of Symbols



Indicates particularly important points related to a function, including precautions and application advice.

CHECK!



Indicates page numbers containing relevant information.



Indicates reference to helpful information and explanations for difficult terminology.

MEMO

Table of Contents

Introduction

Safety Precautions	3
Precautions for Safe Use	4
Precautions for Correct Use	5
How to Read this Manual	7

Section 1 Product Overview 11

Features	12
Using Heat-resistive Tags (V680-D1KP58HTN and V680-D1KP58HT)	14
Names and Functions of Components	19
System Configuration	22
Operation Flowchart	25

Section 2 Communications Preparations 29

V680-CHUD Communications Preparations	30
V680-CH1D Communications Preparations	45
V680-CH1D-PSI Communications Preparations	48
Setting the Hand-held Reader/Writer	49
Communications Test	53

Section 3 Commands 55

Communicating with RF Tags	56
V600 and V680 Command Comparison	57
V680 Commands	59
V600 Commands	83

Section 4 Functions 119

Hand-held Reader/Writer Functions	120
Write Protection Function	121
RF Tag Service Life Detection	123
Memory Check Function in RF Tag	125
RF Tag Memory Error Correction	126

Section 5 Troubleshooting	127
Error Tables	128
Troubleshooting Flowchart	129
Section 6 Appendices	131
Specifications and Dimensions	132
RF Tag Memory Map	149
RF Tag Memory Capacities and Memory Types (V680 Series)	150
List of ASCII Characters	151
Degree of Protection	152
Revision History	154

Section 1

Product Overview

☒ Features	12
☒ Using Heat-resistive Tags (V680-D1KP58HTN and V680-D1KP58HT)	14
☒ Names and Functions of Components	19
☒ System Configuration	22
☒ Operation Flowchart	25

Features

The V680-series Hand-held Reader/Writer incorporates a V680-series Antenna and Controller into a compact design. Data can be read from or written to the RF Tag simply by approaching or touching the RF Tag with the Hand-held Reader/Writer.

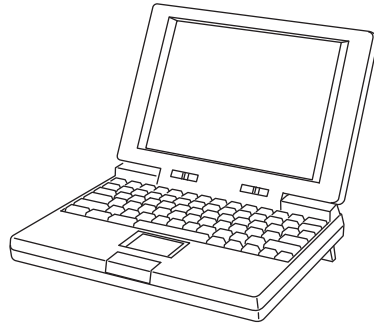

Personal computer

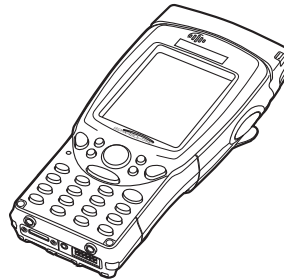

Hand-held Terminal
manufactured by Zebra Technologies Inc.
Hand-held Terminal Recommended
for the V680-CH1D-PSI: Work About Pro

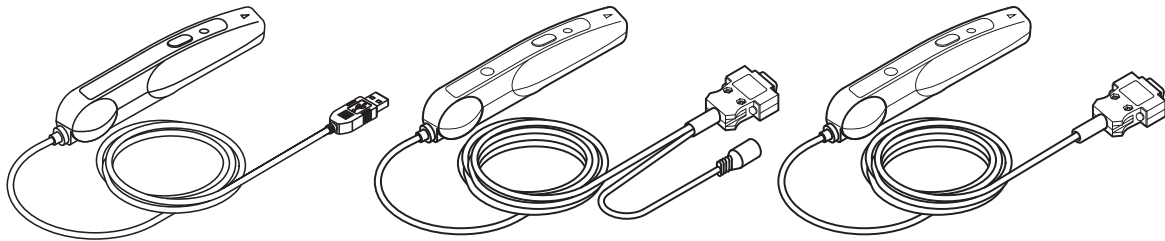

Hand-held Reader/Writers

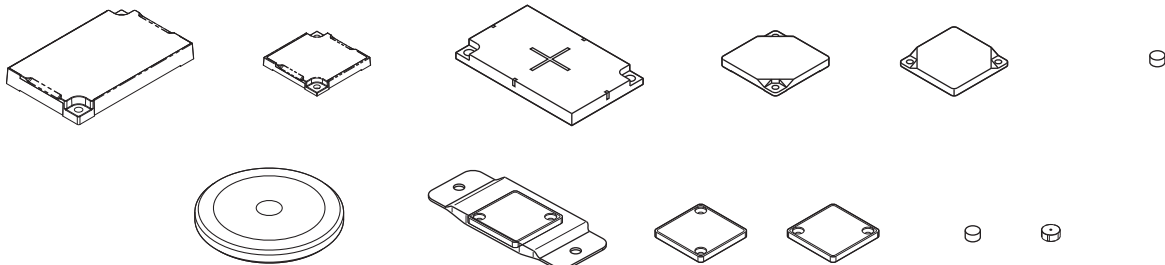

RF Tags

■ V680-CHUD

This Hand-held Reader/Writer provides a USB connector that conforms to the USB 1.1 standard. Connecting the Hand-held Reader/Writer to a personal computer or Hand-held Terminal gives it superior portability, and operability.

■ V680-CH1D

A built-in RS-232C interface allows this Hand-held Reader/Writer to be connected to a personal computer or programmable controller.

■ V680-CH1D-PSI

A built-in RS-232C interface allows this Hand-held Reader/Writer to be connected to a Hand-held Terminal, giving it superior portability, and operability.

■ Differences between Version 1.0 and 1.1

The following functions have been added to version 1.1 in comparison to version 1.0. Functions are upwardly compatible, so version 1.0 can be replaced with version 1.1.

■ CA1D Mode Setting Added for Tag Memory

Setting the Tag memory setting to CA1D Mode enables reading and writing Heat-resistant Tags that were written by the V680-CA1D/-CA2D.

■ Parameter Added to PARAMETER SET (SP) Command

A parameter to set the Tag memory setting was added to the PARAMETER SET (SP) command.



The Tag memory setting is made in the Hand-held Reader/Writer. A different memory map may be used when reading or writing Heat-resistant Tags that were written by the V680-CA1D/-CA2D from a Reader/Writer that is manufactured by a company other than OMRON. Refer to *Operation When Tag Memory Setting Is Set to Standard Mode* in this section.

CHECK!  p.17

■ Checking the Version

■ Version 1.0

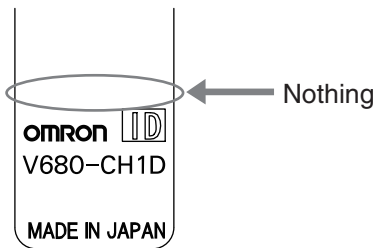

■ Version 1.1

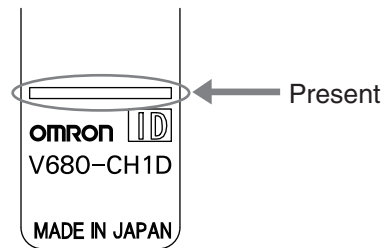

Using Heat-resistant Tags (V680-D1KP58HTN and V680-D1KP58HT)

This section provides information for using Heat-resistant Tags (V680-D1KP58HTN or V680-D1KP58HT). If you are not using a Heat-resistant Tag, set the Tag memory setting to Standard Mode.

Precautions for Saving Data at High Temperatures

If you are using a Heat-resistant Tag, write the data again after saving the data at a high temperature even if it is not necessary to change the data. A "high temperature" is one between 110°C and 200°C.

Using the V680-CA1D/-CA2D

If you are using Heat-resistant Tags (V680-D1KP58HTN or V680-D1KP58HT) and also using the V680-CA1D/-CA2D, set the Tag memory setting of the V680-CH@D (version 1.1 or newer) to CA1D Mode.



If you are not using the V680-CA1D/-CA2D, the Tag memory setting does not need to be changed. Refer to information in *Names and Functions of Components*.

CHECK!

Combining the V680-CA1D/-CA2D with Other Models

When using other models of Controller with the V680-CA1D/-CA2D, make sure that the version allows setting the Tag memory setting to CA1D Mode.



To use the V680-CA5D01-V2/-CA5D02-V2, it must be version 2.3 or newer.
To use the V680-CH@D, it must be version 1.1 or newer.
To use the CS/CJ1W-V680C1@, it must be version 1.2 or newer.

CHECK!



Refer to *Checking the Version* for information on product versions.



p.13

CHECK!

Introduction

The address maps in the RF Tags for the V680-D1KP@@ (except for the V680-D1KP58HT) are reversed between the V680-CA1D/-CA2D ID Controllers and V680-CH@D Hand-held Reader/Writer (with Tag memory setting set to CA1D Mode for version 1.1 or newer), and the V680-CH@D (version 1.0) and V680-CH@D (with Tag memory setting set to Standard Mode for version 1.1 or newer) Hand-held Reader/Writers. Therefore, when you use RF Tags with a V680-CA1D/-CA2D ID Controller, always set the Tag memory setting to CA1D Mode in any other models of ID Controller or Hand-held Reader/Writers that are used for the same RF Tags.

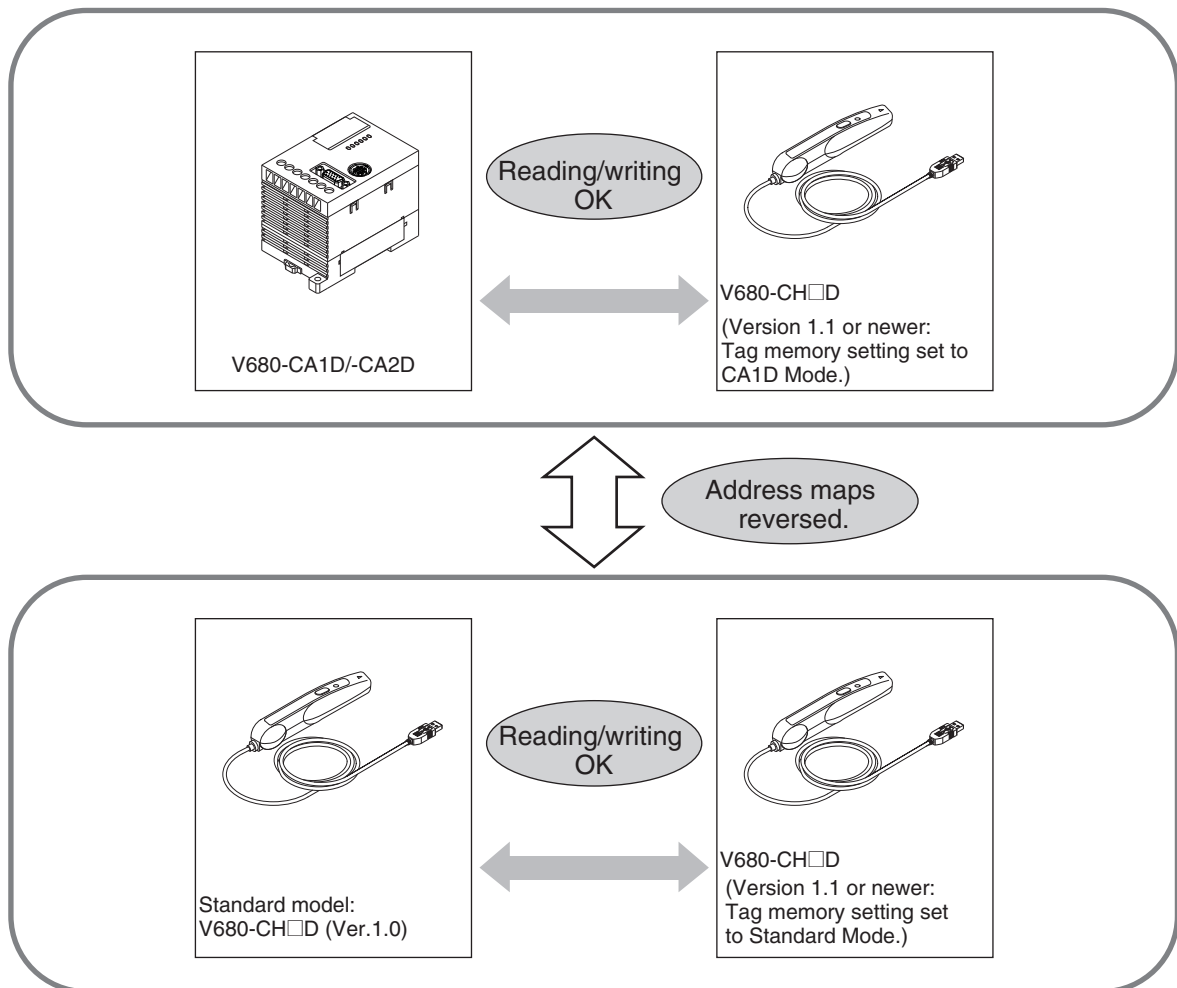

■ Applicable RF Tags

Only the V680-D1KP@@ RF Tags can be used when the Tag memory setting is set to CA1D Mode. V680-D@KF@@ RF Tags cannot be used.

■ RF Tags That Can Be Used

Models
V680-D1KP58HT
V680-D1KP58HTN
V680-D1KP52MT
V680-D1KP53M
V680-D1KP66T
V680-D1KP66MT

■ RF Tags That Cannot Be Used

Models
V680-D2KF52M
V680-D8KF67
V680-D8KF67M
V680-D8KF68
V680-D32KF68
V680S-D2KF67
V680S-D2KF67M
V680S-D2KF68
V680S-D2KF68M
V680S-D8KF67
V680S-D8KF67M
V680S-D8KF68
V680S-D8KF68M

■ CA1D Mode Setting for Tag Memory and Write Protection

When setting the Tag memory setting to CA1D Mode, always disable write protection.

■ Setting the Tag Memory Setting to CA1D Mode

When changing an existing system to use the V680-CA1D/-CA2D, there are restrictions in the command system and write protection function.

The following settings are required if the Tag memory setting is set to CA1D Mode.

- 1.Process code J in PARAMETER SET (SP) command: Set the command system setting to 0 to set the command system to V600 commands.
- 2.Process code H in PARAMETER SET (SP) command: Set the write protection function setting to 1 to disable write protection.
- 3.Process code L in PARAMETER SET (SP) command: Set the Tag memory setting to 1 to set CA1D Mode.



Standard Mode is the default Tag memory setting.

CHECK!



For details on the *PARAMETER SET (SP)* command, refer to *PARAMETER SET (SP)* under *V680 Commands* or *V600 Commands* in *Section 3 Commands*.

CHECK!

p.78, p.116

■ Operation When Tag Memory Setting Is Set to Standard Mode

When data that was written to a V680-D1KP58HTN RF Tag with the V680-CA1D/-CA2D ID Controller is read from a V680-CH@D Hand-held Reader/Writer, the data from addresses that are reversed in one-block (eight-byte) units is read.

If you are going to use a V680-CH@D Reader/Writer in the same line as a V680-CA1D/-CA2D ID Controller, use a V680-CH@D Reader/Writer with version 1.1 or newer and set the Tag memory setting to CA1D Mode.

Address	Data written with V680-CA1D/-CA2D	Data read with V680-CH@D (version 1.0) or V680-CH@D (version 1.1 or newer with Tag memory setting set to Standard Mode)
0000 hex	01 hex	00 hex
0001 hex	23 hex	00 hex
0002 hex	45 hex	00 hex
0003 hex	67 hex	00 hex
0004 hex	89 hex	00 hex
0005 hex	AB hex	00 hex
0006 hex	CD hex	00 hex
0007 hex	EF hex	00 hex
:	:	:
:	:	:
03E0 hex	00 hex	01 hex
03E1 hex	00 hex	23 hex
03E2 hex	00 hex	45 hex
03E3 hex	00 hex	67 hex
03E4 hex	00 hex	89 hex
03E5 hex	00 hex	AB hex
03E6 hex	00 hex	CD hex
03E7 hex	00 hex	EF hex

Addresses are reversed by block.

■ Operation When Tag Memory Setting Is Set to CA1D Mode

If the Tag memory setting for the V680-CH@D (version 1.1 or newer) is set to CA1D Mode, data is read from or written to addresses that are reversed in block units for the V680-D1KP@@ (except for the V680-D1KP58HT) in the same way as for the V680-CA1D/-CA2D. Therefore, data can be read from the same addresses as those to which data was written by the V680-CA1D/-CA2D.

Address	Data written with V680-CA1D/-CA2D	Data read with V680-CH@D (version 1.1 or newer with Tag memory setting set to CA1D Mode)
0000 hex	01 hex	01 hex
0001 hex	23 hex	23 hex
0002 hex	45 hex	45 hex
0003 hex	67 hex	67 hex
0004 hex	89 hex	89 hex
0005 hex	AB hex	AB hex
0006 hex	CD hex	CD hex
0007 hex	EF hex	EF hex
:	:	:
:	:	:
03E0 hex	00 hex	00 hex
03E1 hex	00 hex	00 hex
03E2 hex	00 hex	00 hex
03E3 hex	00 hex	00 hex
03E4 hex	00 hex	00 hex
03E5 hex	00 hex	00 hex
03E6 hex	00 hex	00 hex
03E7 hex	00 hex	00 hex

Same as data read with V680-CA1D/-CA2D.

■ Canceling CA1D Mode

To cancel CA1D Mode, use the PARAMETER SET (SP) command to set the Tag memory setting to Standard Mode.

Process code L: Set the Tag memory setting to Standard Mode. For the V600 protocol, set the tag memory setting to 0. For the V680 protocol, set the tag memory setting to 00.



For details on the *PARAMETER SET (SP)* command, refer to *PARAMETER SET (SP)* under *V680 Commands* or *V600 Commands* in *Section 3 Commands*.

p.78, p.116





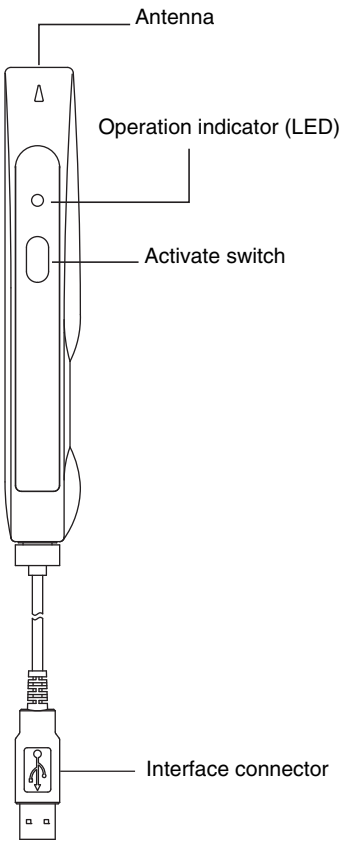

When CA1D Mode is canceled, the address mapping with the RF Tags will be different from the ones written in CA1D Mode. This may cause unexpected addresses to be read or written. When canceling CA1D Mode, initialize the data in the RF Tags before using them.

Names and Functions of Components

V680-CHUD



■ Operation Indicator (LED)

Display	Meaning
 Lit green	A command has been received from the host device.
	Communications with the RF Tag have completed normally.
 Flashing green	When the power is turned ON, after initialization of the Hand-held Reader/Writer is completed.
	Communications with the RF Tag are in progress.
 Lit red	A communications error with the RF Tag has occurred.
	A CPU error has occurred.
 Flashing red	An RF Tag non-existent error has occurred.
	A communications error with the host device has occurred.



After the operation indicator is lit or flashing for a certain time, it will turn OFF.

■ Activate Switch

When button commands or commands with button communications specifications (button trigger or button auto) are used and the activate switch is pressed, communications with the RF Tag will start. (For details on button communications specifications, refer to *Section 3 Commands*.)

■ Interface Connector

This is a USB interface with an A-series plug based on USB 1.1.



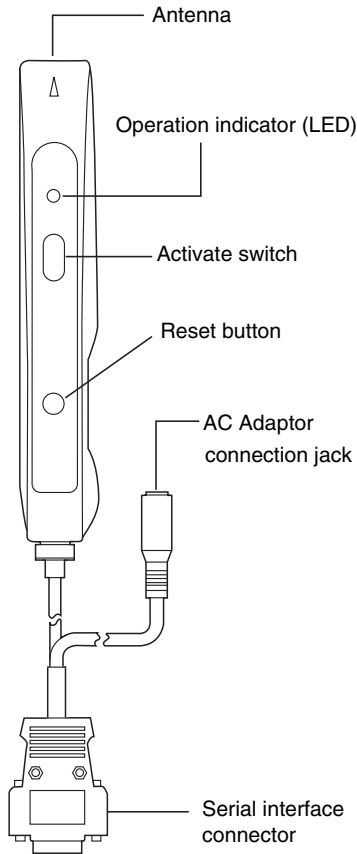

■ Antenna

To communicate with the RF Tag, move the antenna close to it.

V680-CH1D



■ Operation Indicator (LED)

Display	Meaning
 Lit green	A command has been received from the host device.
	Communications with the RF Tag have completed normally.
 Flashing green	<ul style="list-style-type: none"> •When the power is turned ON, after initialization of the Hand-held Reader/Writer is completed •When the power is turned ON and the reset button is pressed for two seconds or more (initialization stand-by mode).
	Communications with the RF Tag are in progress.
 Lit red	A communications error with the RF Tag has occurred.
	A CPU error has occurred.
 Flashing red	An RF Tag non-existent error has occurred.
	A communications error with the host device has occurred.



After the operation indicator is lit or flashing for a certain time, it will turn OFF.

■ Activate Switch

When button commands or commands with button communications specifications (button trigger or button auto) are used and the activate switch is pressed, communications with the RF Tag will start. (For details on button communications specifications, refer to *Section 3 Commands*.)

If the activate switch is pressed with the Hand-held Reader/Writer in the initialization stand-by mode (with the green indicator flashing), the function settings will be initialized.

■ Reset Button

Press this button for two seconds or more when the power is first turned ON to put the Hand-held Reader/Writer into the initialization stand-by mode.

■ AC Adaptor Connection Jack

This is a connection jack for the V600-A22 AC Adaptor.

■ Serial Interface Connector



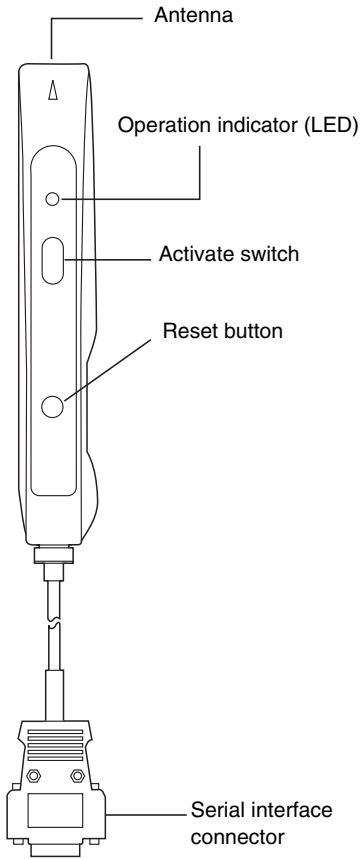

This is a serial interface with an RS-232C-compliant D-Sub 9-pin connector.

■ Antenna

To communicate with the RF Tag, move the antenna closer to it.
V680-CH1D-PSI



■ Operation Indicator (LED)

Display	Meaning
 Lit green	A command has been received from the host device.
	Communications with the RF Tag have completed normally.
 Flashing green	<ul style="list-style-type: none"> •When the power is turned ON, after initialization of the Hand-held Reader/Writer is completed. •When the power is turned ON and the reset button is pressed for two seconds or more (initialization stand-by mode).
	Communications with the RF Tag are in progress.
 Lit red	A communications error with the RF Tag has occurred.
	A CPU error has occurred.
 Flashing red	An RF Tag non-existent error has occurred.
	A communications error with the host device has occurred.



After the operation indicator is lit or flashing for a certain time, it will turn OFF.

■ Activate Switch

When button commands or commands with button communications specifications (button trigger or button auto) are used and the activate switch is pressed, communications with the RF Tag will start. (For details on button communications specifications, refer to *Section 3 Commands*.)

If the activate switch is pressed with the Hand-held Reader/Writer in the initialization stand-by mode (with the green indicator flashing), the function settings will be initialized.

■ Reset Button

Press this button for two seconds or more when the power is first turned ON to put the Hand-held Reader/Writer into the initialization stand-by mode.

■ Serial Interface Connector

This is a serial interface with an RS-232C-compliant D-Sub 9-pin connector.

■ Antenna

To communicate with the RF Tag, move the antenna closer to it.

System Configuration

V680-CHUD

The V680-CHUD Hand-held Reader/Writer can communicate with host devices that have a USB interface, such as personal computers.

Host Devices

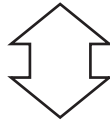
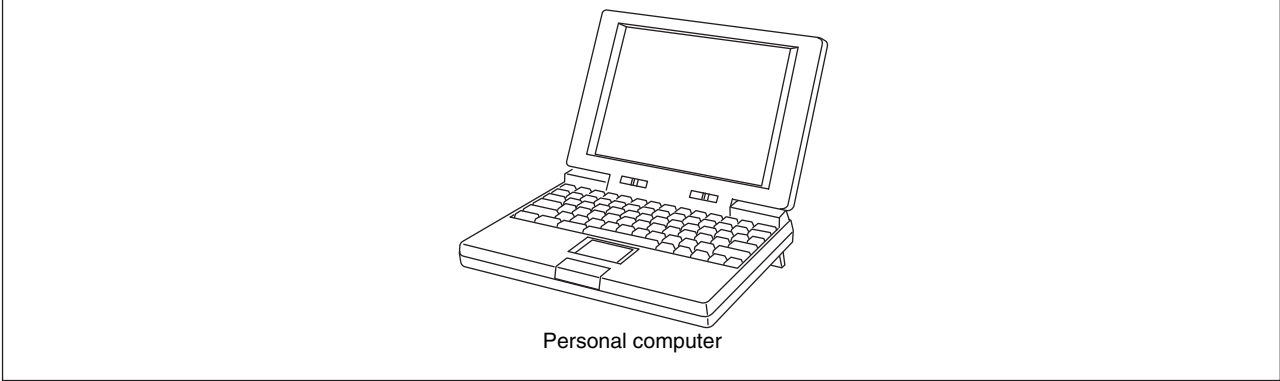

Hand-held Reader/Writer

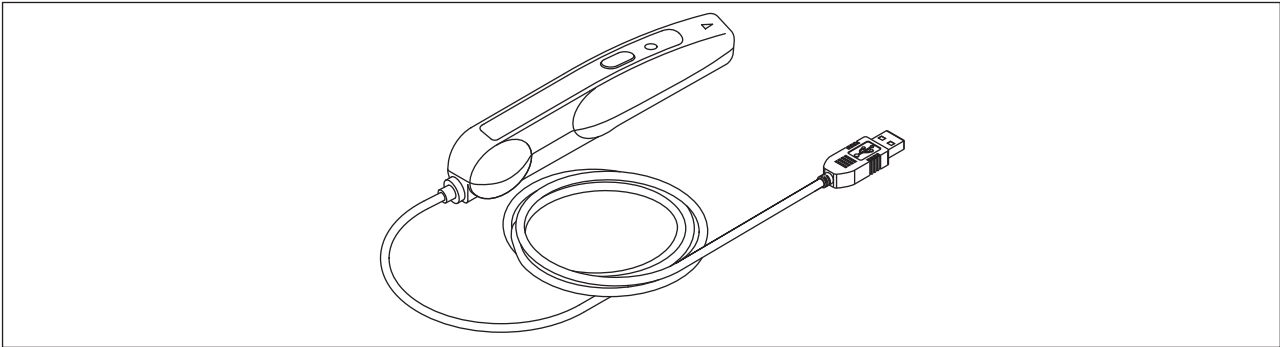

RF Tags

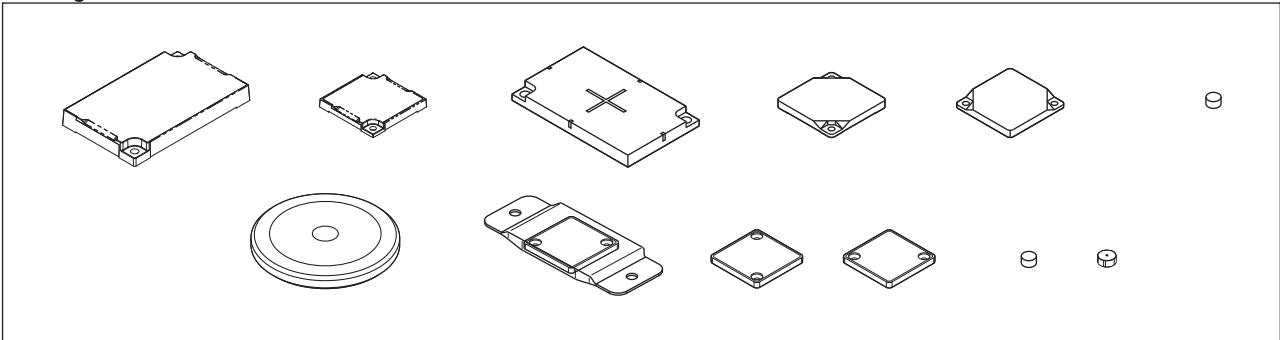

The V680-CHUD Hand-held Reader/Writer can be used with any RF Tag in the V680/V680S Series.



For details on Hand-held Reader/Writer and RF Tag models, refer to *Section 6 Appendices*.

CHECK!

 p.132, p.150



When using a V680-D8KF@@, to use the V680-CHUD of production after October 2014.

CHECK!

V680-CH1D

A built-in RS-232C serial interface in the V680-CH1D Hand-held Reader/Writer allows communication with personal computers and programmable controllers that are equipped with an RS-232C interface.

Host Devices

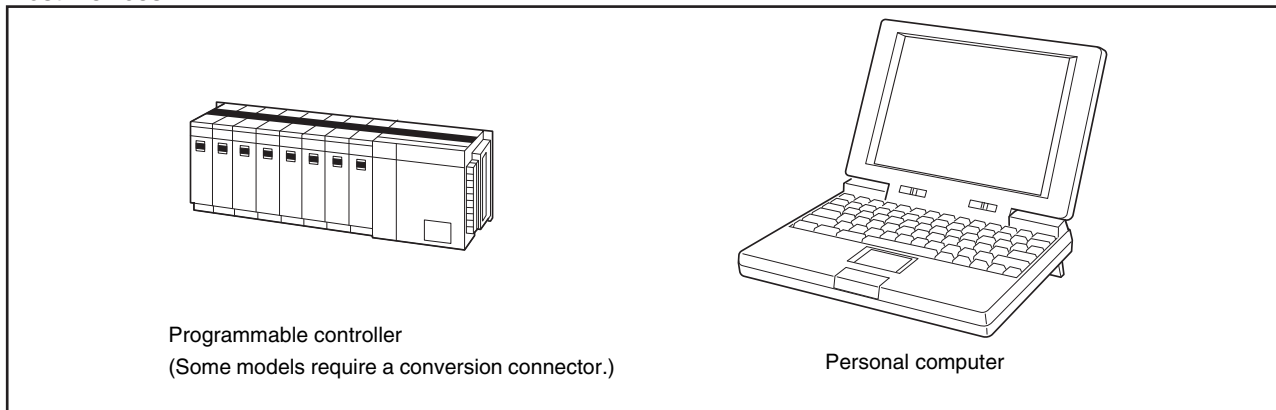

Hand-held Reader/Writer

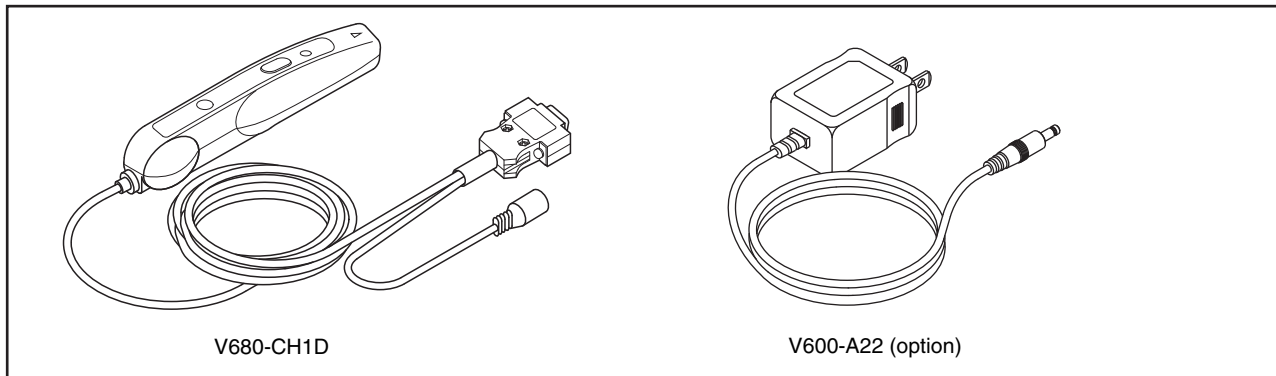

RF Tags

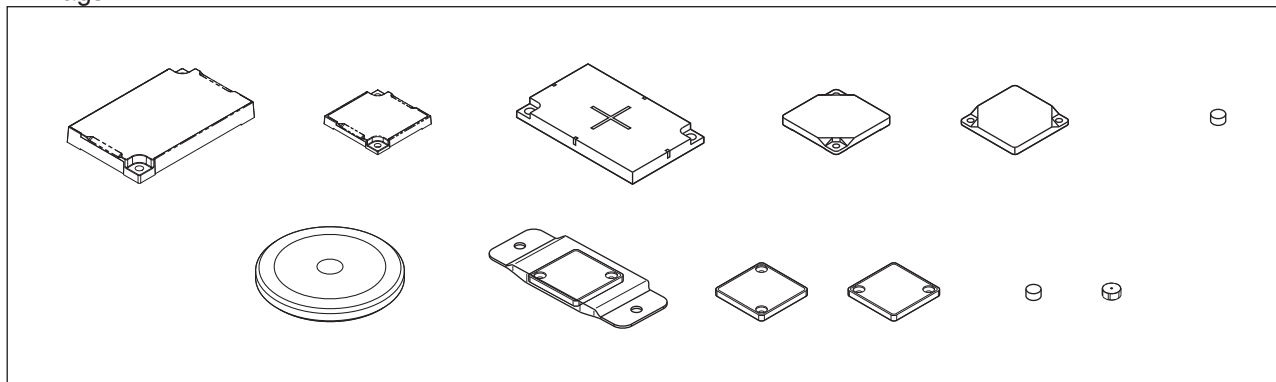

The V680-CH1D Hand-held Reader/Writer can be used with any RF Tag in the V680/V680S Series.



For details on Hand-held Reader/Writer and RF Tag models, refer to *Section 6 Appendices*.

CHECK!



p.132, p.150



CHECK!

When using a V680-D8KF@@, to use the V680-CH1D of production after October 2014.

V680-CH1D-PSI

A built-in RS-232C serial interface in the V680-CH1D-PSI Hand-held Reader/Writer allows communications with personal computers and programmable controllers that are equipped with an RS-232C interface

Host Devices

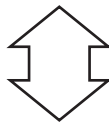
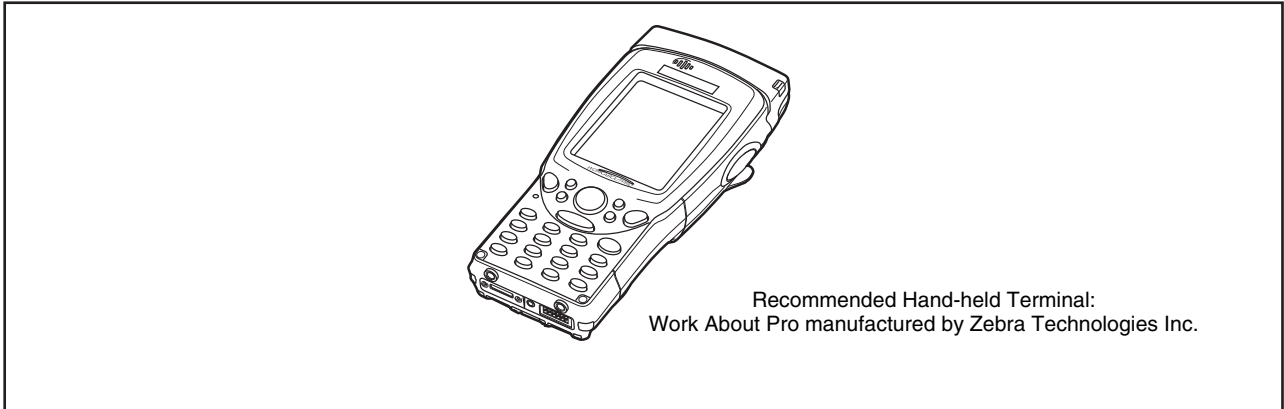

Hand-held Reader/Writer

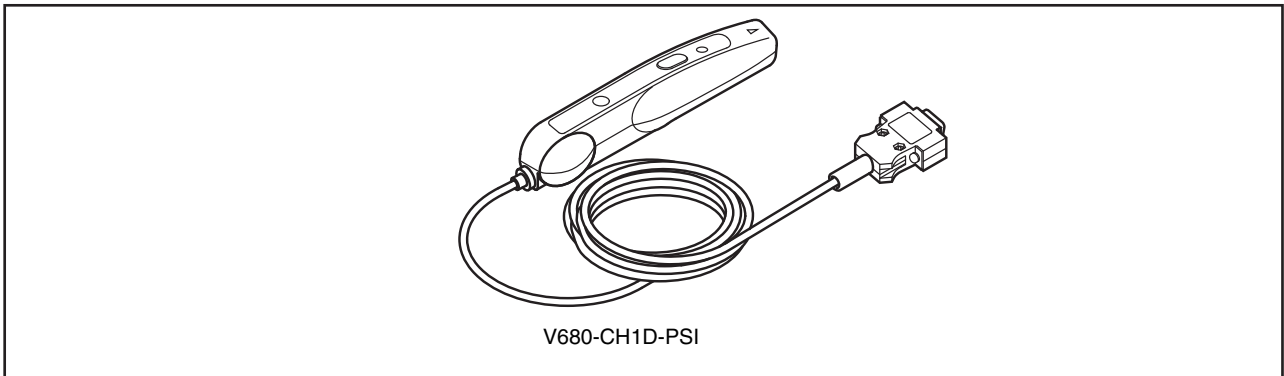

RF Tags

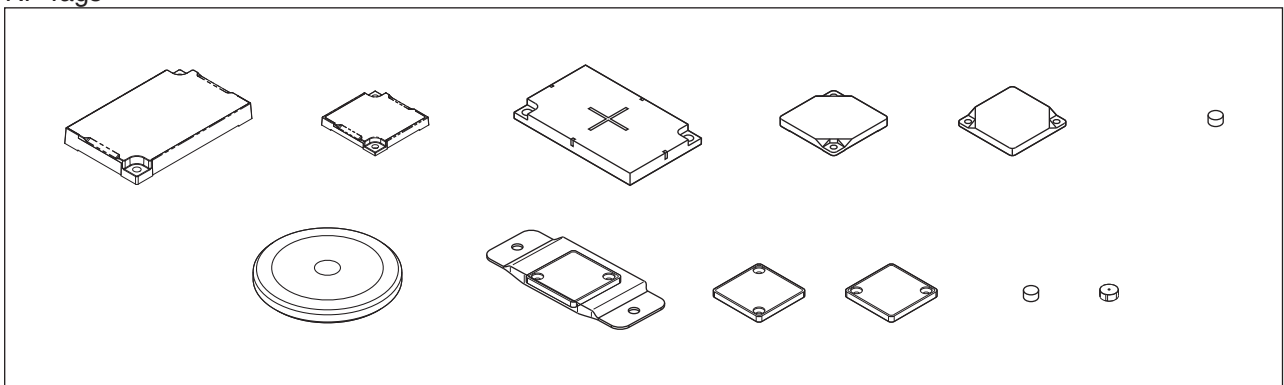

The V680-CH1D-PSI Hand-held Reader/Writer can be used with any RF Tag in the V680/V680S Series.



For details on Hand-held Reader/Writer and RF Tag models, refer to *Section 6 Appendices*.

CHECK!

 p.132, p.150



When using a V680-D8KF@@, to use the V680-CH1D-PSI of production after October 2014.

CHECK!

Operation Flowchart

V680-CHUD

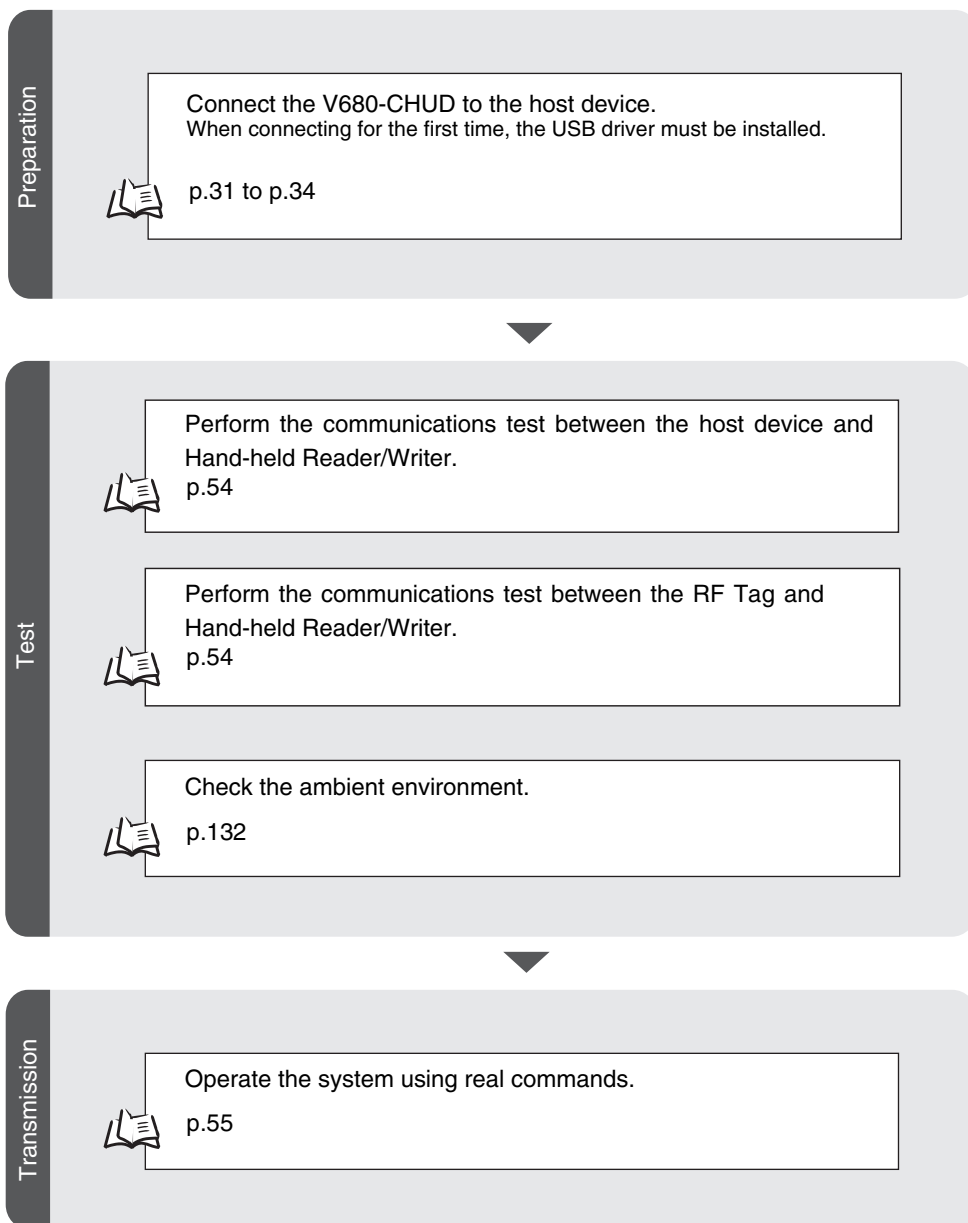

V680-CH1D

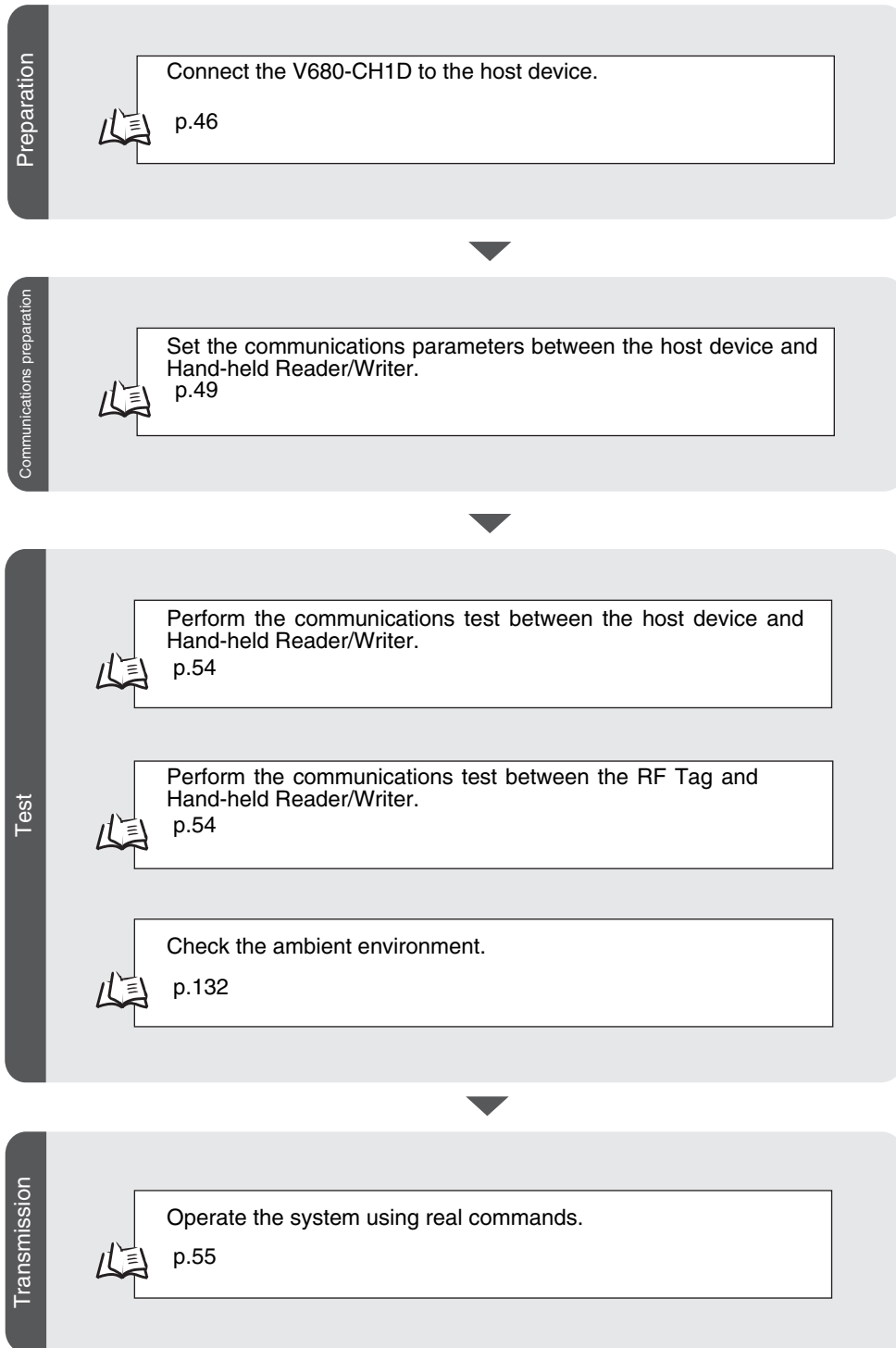

V680-CH1D-PSI

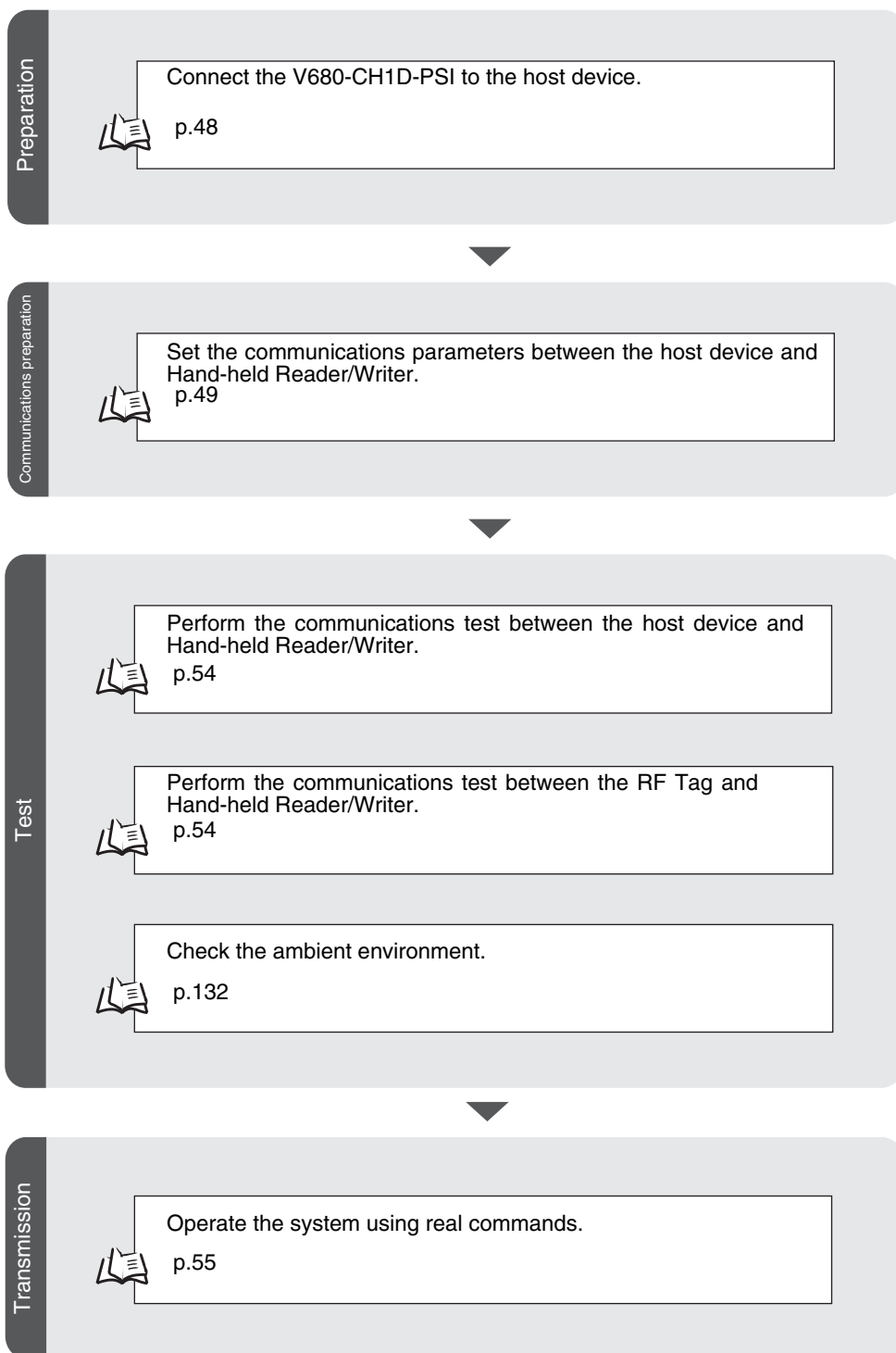

MEMO

Section 2

Communications Preparations

☒ V680-CHUD Communications Preparations	30
☒ V680-CH1D Communications Preparations	45
☒ V680-CH1D-PSI Communications Preparations	48
☒ Setting the Hand-held Reader/Writer	49
☒ Communications Test	53

V680-CHUD Communications Preparations

Connections

■ Connecting the Cable

1. Connect the cable connector to the USB connector on the host device, making sure that the connector is oriented correctly and not inserted at an angle.

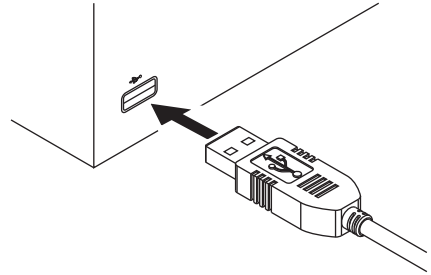

■ Removing the Cable

1. Remove the cable.
Close the software application at the host device and then pull out the connector in a straight line, not at an angle.



If the connector is removed while the software is running at the host device, operation may stop due to a software malfunction error. Restart the software if operation becomes impossible.

CHECK!

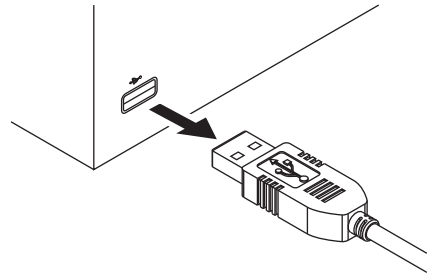

Installing the USB Driver (V680-CHUD)

When connecting the Hand-held Reader/Writer to the host device for the first time, the USB driver must be installed at the host device.

■ Downloading the USB Driver

Download the USB Driver for the V680-CHUD from the web site.
For details, ask your OMRON sales representative.

■ Installing the USB Driver

The V680-CHUD supports the Windows XP, Windows 7 or Windows 10 operating system. Install the driver in the host personal computer using the following procedure.
Operation on other operating systems is not supported.

Windows XP

1. Turn ON the power to the personal computer and start Windows XP.
2. Connect the Hand-held Reader/Writer to the personal computer.



Wait for the following window to be displayed.

3. When the following dialog box is displayed, select the *Install from a list or specific location (Advanced)* Option and click the **Next** Button.

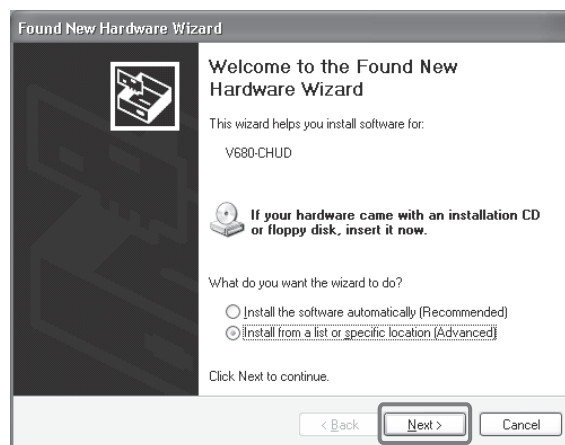

4. Click the **Browse** Button when the Found New Hardware Wizard Dialog Box appears, select the folder in which the downloaded file *V680-CHUD_100.inf* was saved, and click the **Next** button.

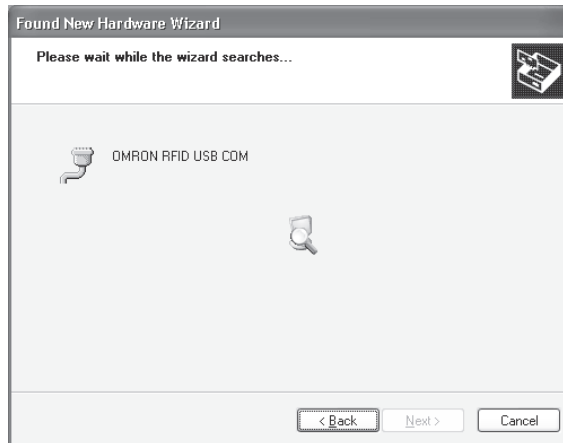
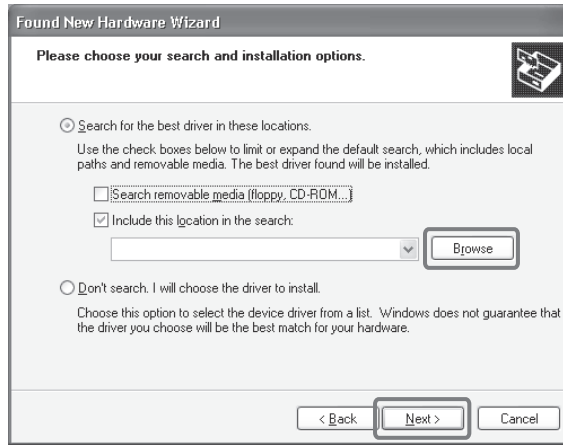

5. Click the **Continue Anyway** Button.



6. The USB Driver installation will begin.

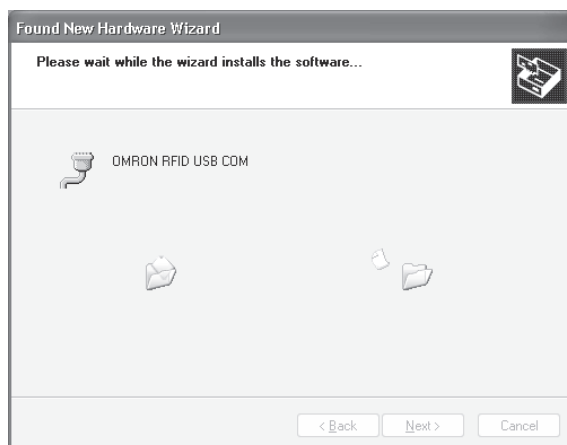

7. When the following window is displayed, installation has been completed.

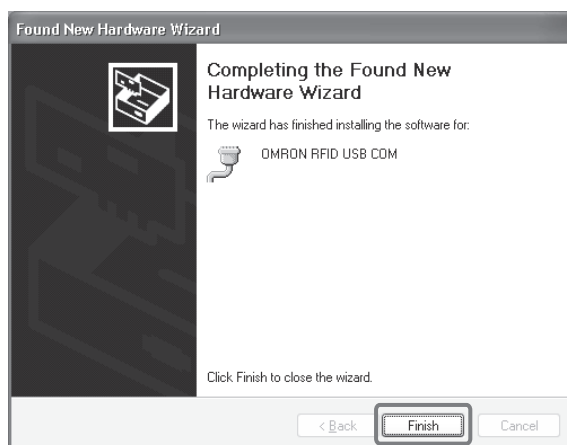

8. Click the **Finish** Button.

- **Checking Installation**
Check that the driver is correctly installed.

1. Connect the Hand-held Reader/Writer to the personal computer.
2. On the **Start Menu**, select **Control Panel - System**.
3. Click the **Device Manager** Button in the Hardware Tab Page.

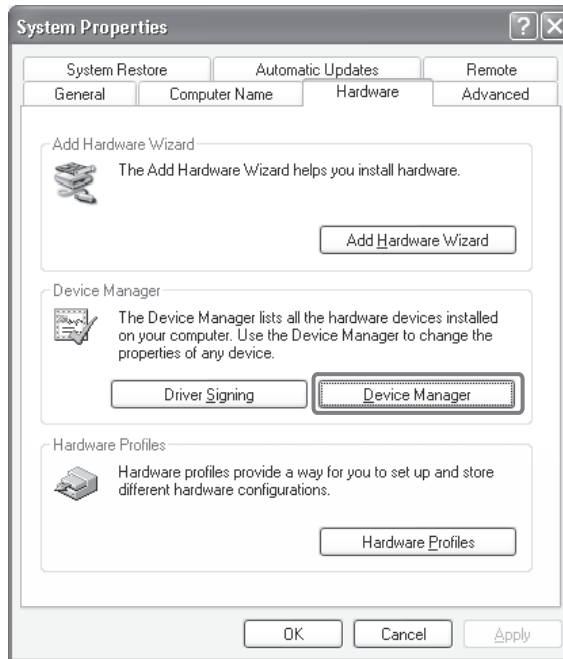

4. Select **Ports (COM & LPT)**, and check that **OMRON RFID USB COM** is displayed.
The driver is correctly installed if this port is displayed.

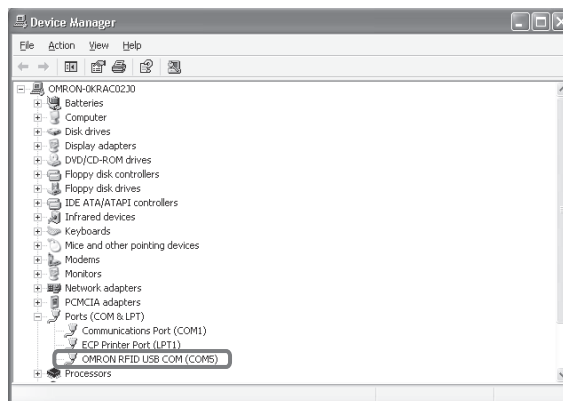



Communications with the Hand-held Reader/Writer can be performed with the COM number displayed in parentheses after **OMRON RFID USB COM**.

Windows 7

1. Turn ON the power to the personal computer and start Windows 7.

2. Connect the ID Controller to the computer via USB.

 Refer to *Connections* for information on the connection method.
CHECK!  p.30

3. Select **Settings - Control Panel - System and Security** from the Windows Start Menu.

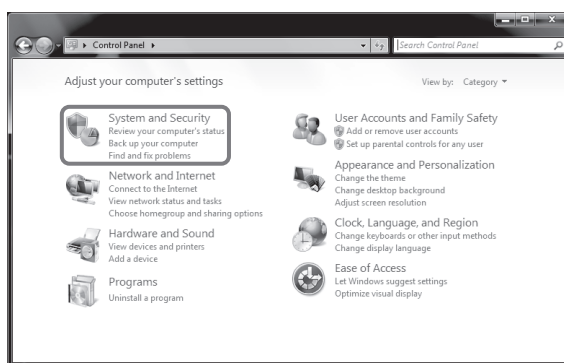

4. Click the **Device Manager** Button.

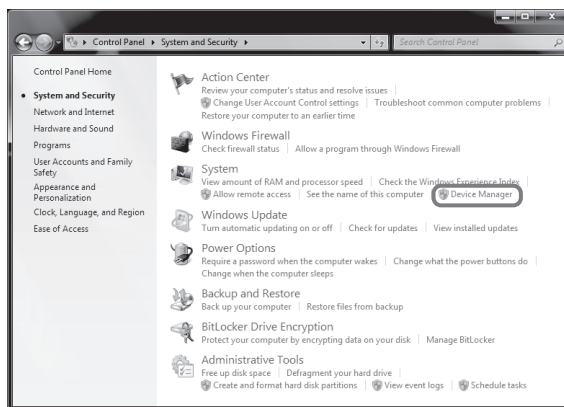

5. Right-click the **Other devices - V680-CHUD** and click the **Properties**.

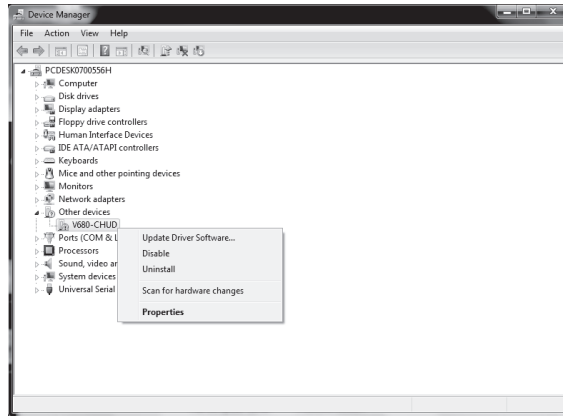

6. Click the **Update Driver** Button.

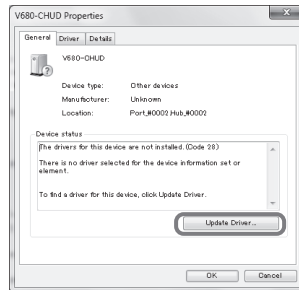

7. Once the following dialog box has been displayed, click the **Browse my computer for driver software** Button.

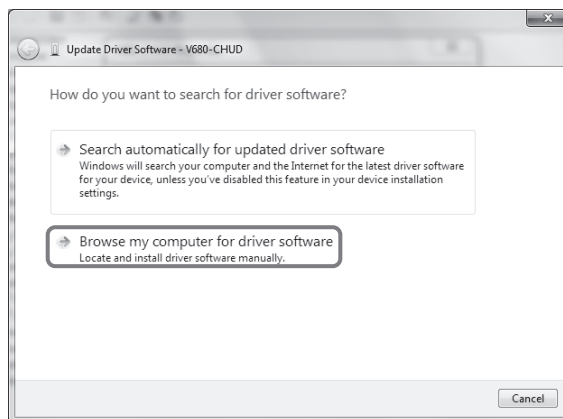

- Click the **Browse** Button and select the folder where the downloaded V680-CHUD_100_win7_@@.inf is to be saved. Then click the **Next** Button.

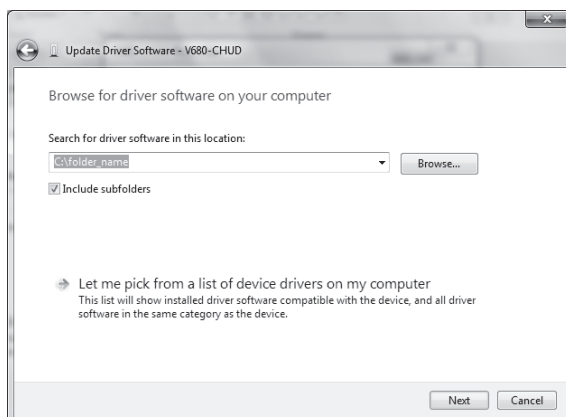

- Click the **Install this driver software anyway** Button.

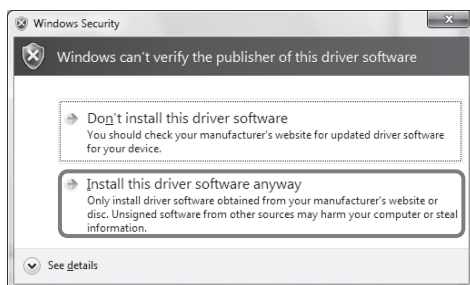

The following dialog box will be displayed when the software installation has been completed.

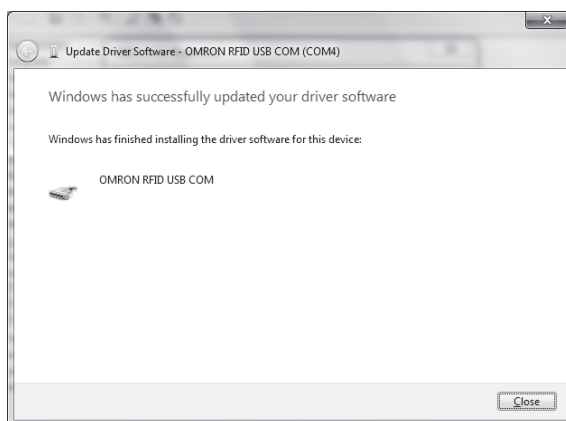

- Click the **Close** Button.

▪ **Checking Installation**

Use the following procedure to confirm that the driver has been correctly installed.

1. Turn ON the power to the personal computer and start Windows 7.

2. Connect the ID Controller to the computer via USB.

Refer to *Connections* for information on the connection method.

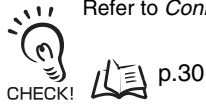

3. Select **Settings - Control Panel - System and Security** from the Windows Start Menu.

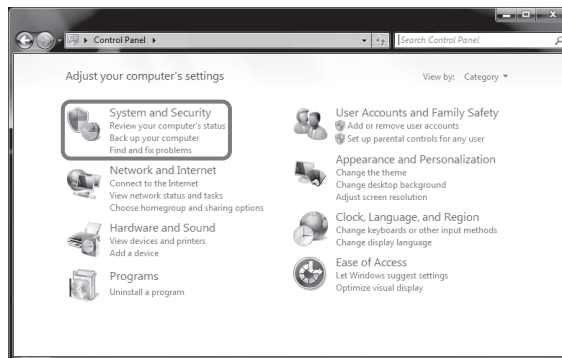

4. Click the **Device Manager** Button.

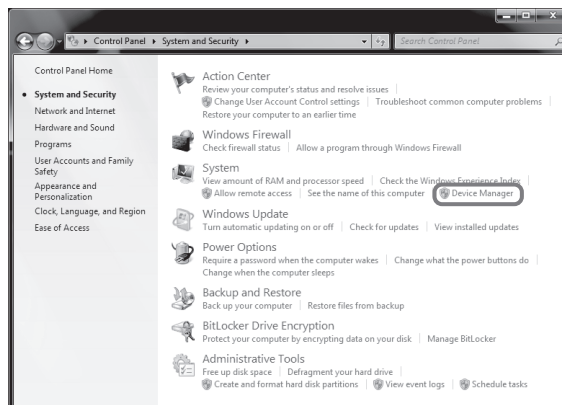

- Right-click the **Other devices - V680-CHUD** and click the **Properties**.

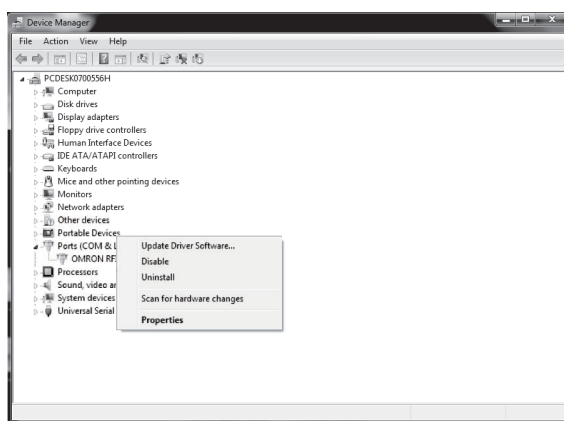

- Select **Ports (COM & LPT)**, and check that OMRON RFID USB COM is displayed. If the driver is correctly installed, the property window for the V680-CHUD will be displayed as follows:

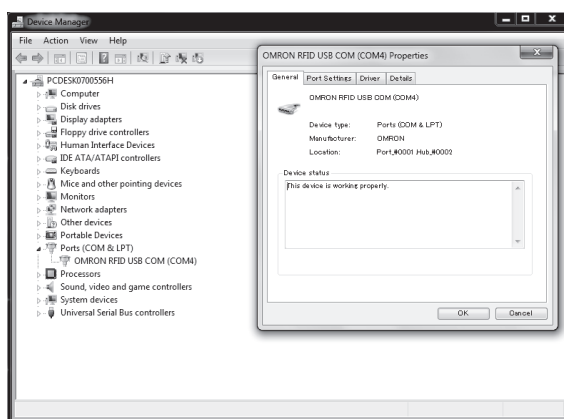

Communications with the ID Controller can be performed with the COM number displayed in parentheses after OMRON RFID USB COM.

Windows 10

1. Turn ON the power to the personal computer and start Windows 10.

2. Connect the ID Controller to the computer via USB.

Refer to *Connections* for information on the connection method.



3. Select **Settings - Windows System - Control Panel - System and Security** from the Windows Start Menu.

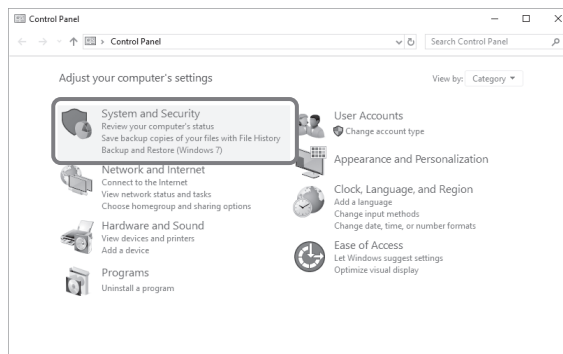

4. Click the **System** Button.

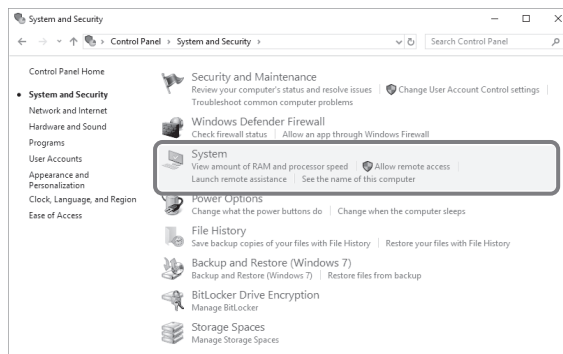

5. Click the **Device Manager** Button.

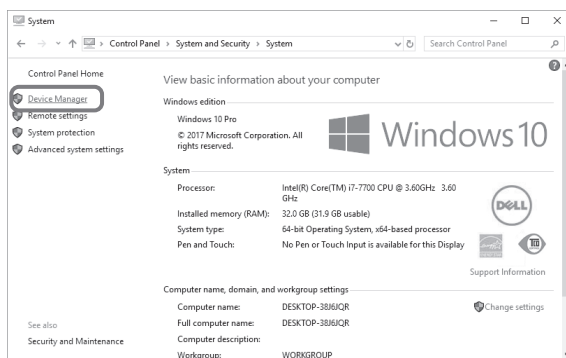

6. Right-click the **Ports - USB Serial Device (COM)** and click the **Update driver**.

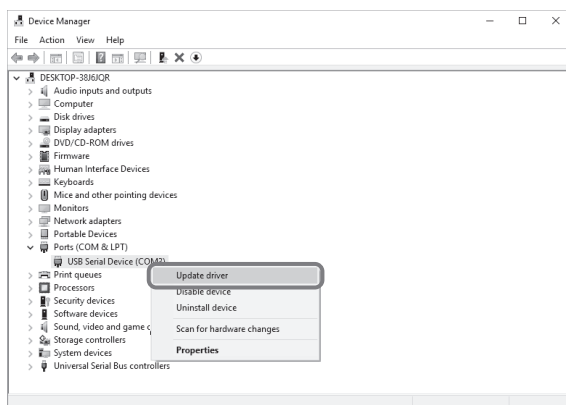

7. Once the following dialog box has been displayed, click the **Browse my computer for driver software** Button.

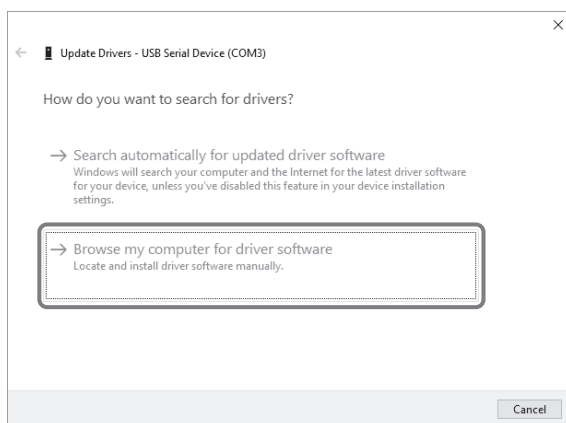

8. Click the **Browse** Button and select the folder where the downloaded V680-CHUD_100_win10_@@.bat is to be saved. Then click the **Next** Button.

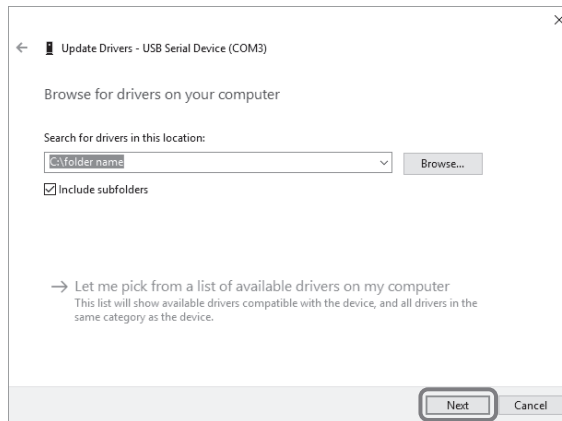

9. The USB Driver installation will begin.

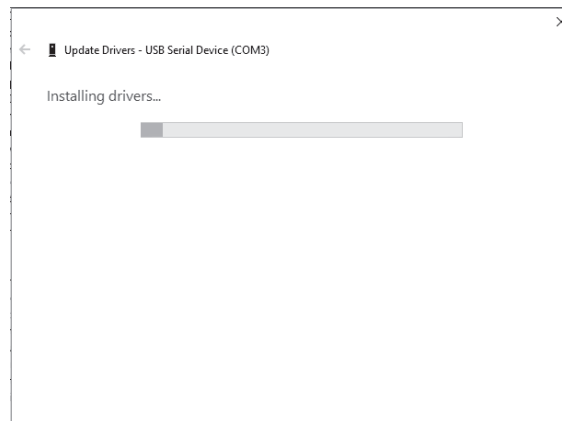

The following dialog box will be displayed when the software installation has been completed.

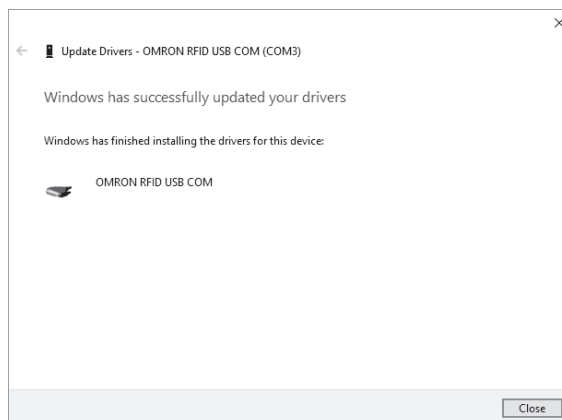

10. Click the **Close** Button.

▪ **Checking Installation**

Use the following procedure to confirm that the driver has been correctly installed.

1. Turn ON the power to the personal computer and start Windows 10.

2. Connect the ID Controller to the computer via USB.

Refer to *Connections* for information on the connection method.



CHECK!

p.30

3. Select **Settings - Windows System - Control Panel - System and Security** from the Windows Start Menu.

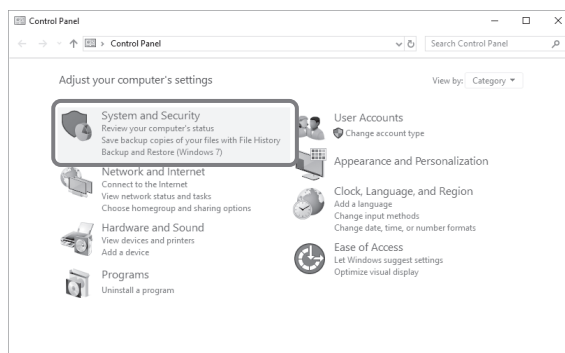

4. Click the **System** Button.

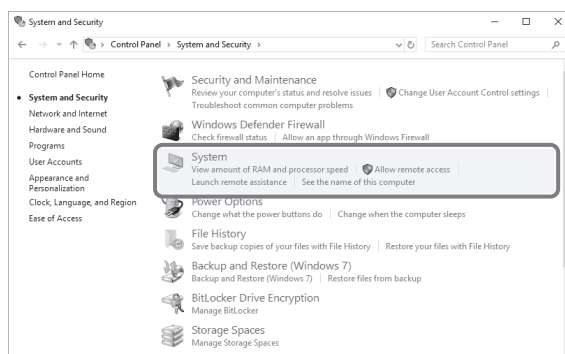

5. Click the **Device Manager** Button.

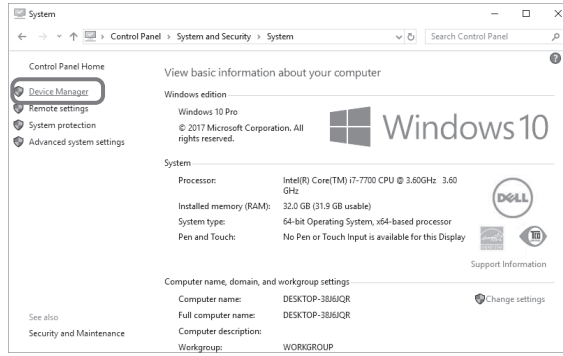

6. Right-click the **Ports - OMRON RFID USB (COM)**, and check the **Update driver**.
If the driver is correctly installed, the property window for the V680-CHUD will be displayed as follows:

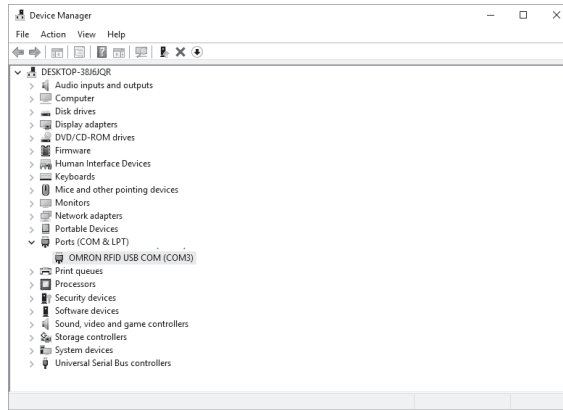

Communications with the ID Controller can be performed with the COM number displayed in parentheses after OMRON RFID USB COM.

V680-CH1D Communications Preparations

Pin Arrangement of the Host Device Interface Connector

V680-CH1D

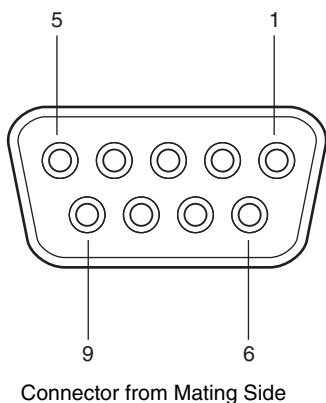

Pin No.	Signal (See note.)	Code (See note.)	Signal direction
1	---		---
2	Receive data	RD	Hand-held Reader/Writer to host device
3	Send data	SD	Host device to Hand-held Reader/Writer
4	---	---	---
5	Signal ground	SG	---
6	(Reserved)	---	---
7	Request send	RS	Loops inside connector
8	Enable send	CS	
9	---	---	---

Note: The names of signals at the host device are abbreviated with codes.

Note: For conversion to a 25-pin connector, the SGC-X9P/25P-2 manufactured by Sunhayato, or an equivalent, is recommended.

■ Connection with the Host Device

Use the following procedure to connect the V680-CH1D to the host device.

1. Connect the V680-CH1D to the RS-232C interface of the host device.
 - When connecting to an IBM PC/AT or compatible:

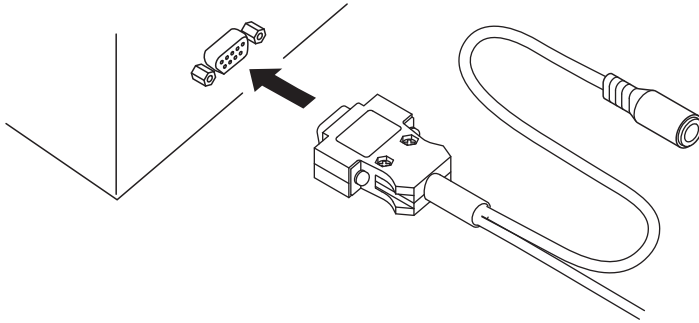

- When connecting to a PC9801-series computer (D-Sub 25-pin connector):
To convert from a 9-pin connector to a 25-pin connector, use an SGC-X9P25P-2 conversion connector manufactured by Sunhayato, or an equivalent product.

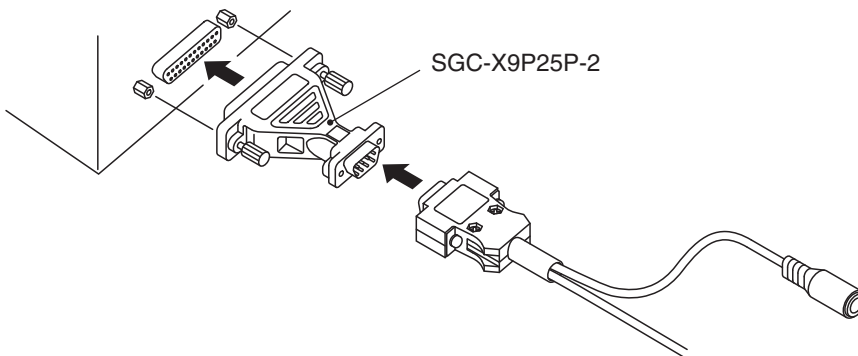

2. Connect the V600-A22 AC Adaptor to the V680-CH1D.

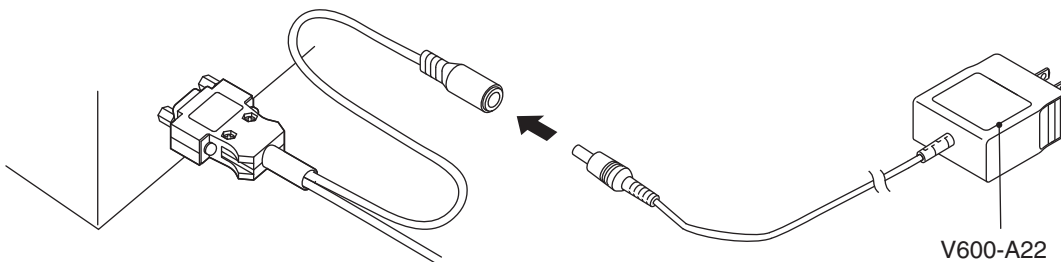

3. Plug the V600-A22 AC Adaptor into a 100- to 120-VAC power outlet.



- Do not use any AC adaptor other than the specified one (V600-A22).
- Using any AC adaptor other than the specified one may cause a malfunction, damage, or fire in the V600-CH1D.
- Some host devices require a conversion connector.

CHECK!

- When connecting to a CQM1, CJ1, CS1, etc.

Prepare a connection cable as shown in the connection examples below.

Note: Because both the V680-CH1D interface connector and the interface connector of the CQM1, CJ1, and CS1 are sockets, a conversion connector is necessary to connect them. Also, the pin arrangement of the CQM1, CJ1, and CS1 interface connector is different from the RS-232C pin arrangement of a personal computer.

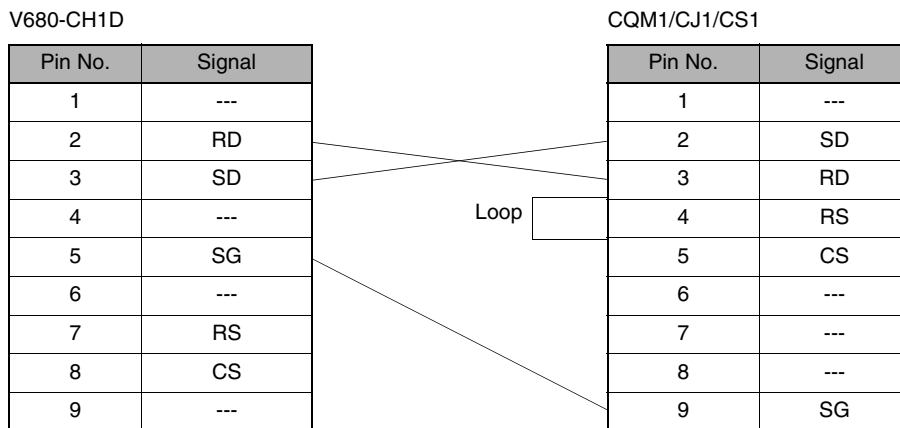

V680-CH1D-PSI Communications Preparations

Pin Arrangement of the Host Device Interface Connector

V680-CH1D-PSI

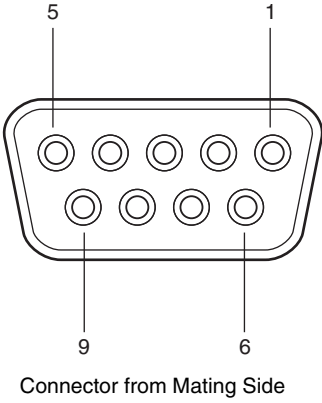

Pin No.	Signal (See note.)	Code (See note.)	Signal direction
1	---		---
2	Receive data	RD	Hand-held Reader/Writer to host device
3	Send data	SD	Host device to Hand-held Reader/Writer
4	---	---	---
5	Signal ground	SG	---
6	Reserved	---	---
7	Request send	RS	Loops inside connector
8	Enable send	CS	
9	5 VDC	---	Host device to Hand-held Reader/Writer

Note: The names of signals at the host device are abbreviated with codes.

■ Connection with the Host Device

Use the following procedure to connect the V680-CH1D-PSI to the host device.

1. Connect the V680-CH1D-PSI to the RS-232C interface of the host device.

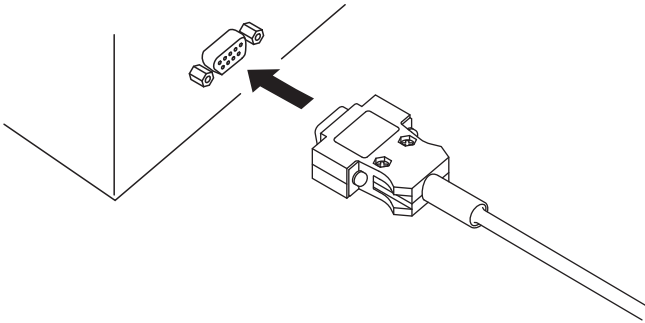

Setting the Hand-held Reader/Writer

Settings

The following settings are used to operate the Hand-held Reader/Writer.

- Serial communications parameters (baud rate, transmission code, parity check, stop bits)
- Basic function settings (Auto Command OFF)

These settings can be changed by sending a setting command from the host device. To operate the Hand-held Reader/Writer with the new setting, the power must be turned OFF then ON again, or the ABORT command must be used.

Serial Communications Parameters

The following settings are related to serial communications. Use the COMMUNICATIONS CONDITIONS SETTING (TR) command.

Item	Contents
Baud rate (bps)	2,400, 4,800, 9,600*, 19,200, 38,400
Transmission code	7-unit ASCII 7* or 8-unit JIS 8
Parity check	Even parity*/odd parity/none
Stop bits	2*/1

Note: Items marked by an asterisk (*) are set as the default when shipped from the factory.

Basic Function Settings

The Auto Command OFF function can be set. Use the BASIC FUNCTIONS SETTING (FN) command.

Item	Contents
Auto Command OFF function	Yes (1 minute)*, No

Note: Items marked by an asterisk (*) are set as the default when shipped from the factory.

Reading the Settings

Use the SET INFORMATION READ (UL) command to read the settings of the Hand-held Reader/Writer. The information read by the SET INFORMATION READ command is set in the backup memory of the Hand-held Reader/Writer. For this reason, care must be taken when the power is first turned ON after the settings have been changed because the operational settings of the Hand-held Reader/Writer will be different.

Setting the Operating Parameters

To optimize Hand-held Reader/Writer performance and reliability, operating parameters can be set to match the application. The following parameters can be set: the inter-character monitoring time, response delay time, auto command cancel time, write protection setting, and protocol.

Usually there will be no problem if the default settings are used, but the system can be optimized by setting following parameters.

These parameters are stored in the internal memory of the Hand-held Reader/Writer and are saved even if the power is turned OFF. When the internal settings are changed with the PARAMETER SET command (SP), it is not necessary to reset the Hand-held Reader/Writer. The changes will be effective immediately after the PARAMETER SET command is executed.



The PARAMETER SET command is also used to read the parameter settings. For details on the PARAMETER SET command, refer to *PARAMETER SET (SP)* in Section 3.

CHECK! p.78, p.116

Inter-character Monitoring Time

The Hand-held Reader/Writer recognizes a command when it receives the end code of a command string that is sent from the host device. However, if for some reason the command is only partially received, the Hand-held Reader/Writer will monitor for a fixed period of time after the last character in the command string is received. If the complete command string is not received after the fixed period of time has expired, a format error (end code: 14) will be returned.

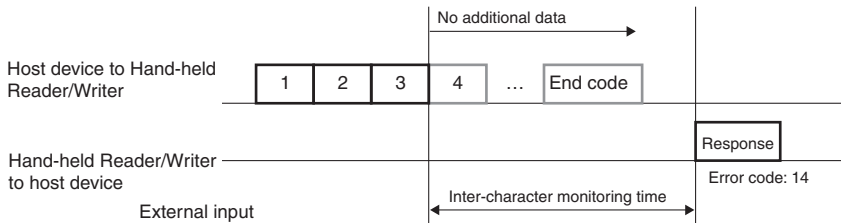

Setting range
0 to 9,999 (ms)

Note: Default value: 99 (ms)

Response Delay Time

The start of returning a response can be changed by setting the response delay time.



The actual time from when sending the command has been completed until returning the response is started is the Hand-held Reader/Writer's internal processing time (minimum: 0 ms) plus the response delay time (a set value).

CHECK!

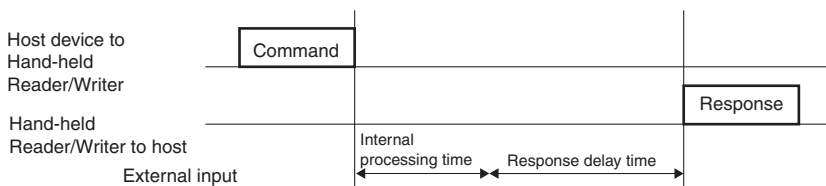

Setting range
0 to 99 (ms)

Note: Default value: 20 (ms)

■ Auto Command Cancel Time

The auto command cancel time is used to set the amount of time from after an auto command is sent until the command processing will be aborted.

After waiting for the tag for a fixed period of time, an "RF Tag non-existent" error (error code: 72) will be returned to the host device.

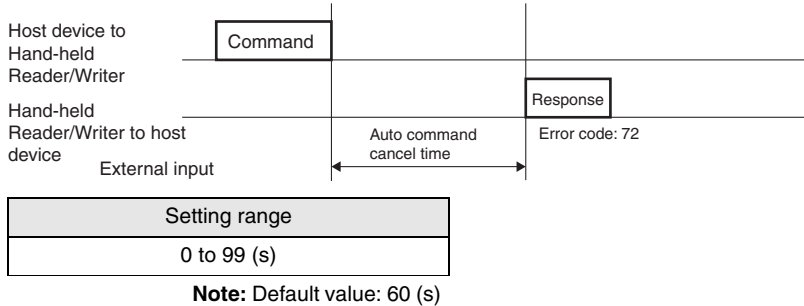



■ Write Protection Enable Setting

The write protection enable setting can be used to enable or disable write protection.

00: Write protection function disabled

01: Write protection function enabled default value



 For details on write protection settings, refer to *Write Protection Function* in *Section 4*.
 p.121
CHECK!

■ Protocol Switch

The protocol switch is used to set whether the Hand-held Reader/Writer will use the V680 command format or the V600 command format.

0: V600 commands (default value)

1: V680 commands

 For details, refer to *Section 3 Commands*.
 p.55
CHECK!

■ Tag Memory Setting



The CA1D Mode in the Tag memory setting is used only when using the V680-CA1D/-CA2D.

If you are using the V680-CA1D/-CA2D, set the Tag memory setting to CA1D Mode.

If you are not using the V680-CA1D/-CA2D, set the Tag memory setting to Standard Mode.

0: Standard Mode (default value)

1: CA1D Mode

 Refer to Using Heat-resistive Tags (V680-D1KP58HTN and V680-D1KP58HT) in *Section 1 Product Overview* for information on using Using Heat-resistive Tags (V680-D1KP58HTN or V680-D1KP58HT).
 p.14
CHECK!

 CA1D Mode can be used with version 1.1 or newer.
Use the VERSION READ (VS) command to read the product version. For details on the VERSION READ (VS) command, refer to *VERSION READ (VS)* under *V680 Commands or V600 Commands* in *Section 3 Commands*.
CHECK!

 p.80, p.111

Initializing the Settings

A setting command is used to set the Hand-held Reader/Writer but if the communications parameters are not known or if the setting contents are damaged, it is possible that communications will no longer be possible with the host device. If this occurs, press both the reset button and the activate switch when turning ON the power. This will return all settings to the defaults set when the Hand-held Reader/Writer was shipped from the factory, allowing communications with the host device again.

■ Reset Procedure

1. Turn ON the power while pressing the reset button.
2. Keep the reset button depressed for two seconds or more. The green operation indicator will start flashing.
3. With the green operation indicator flashing, remove your finger from the reset button and press the activate switch.
4. When the activate switch is pressed, the operation indicator will stop flashing green. This indicates that all of the settings have been initialized.

Note: If the activate switch is not pressed within 30 seconds from the time that the operation indicator starts flashing green, the settings will not be initialized.



CHECK!

The V680-CHUD does not have a reset button. To reset the V680-CHUD, shut down the software on the host device, and disconnect and reconnect the connector.

Communications Test

Test Run Procedure

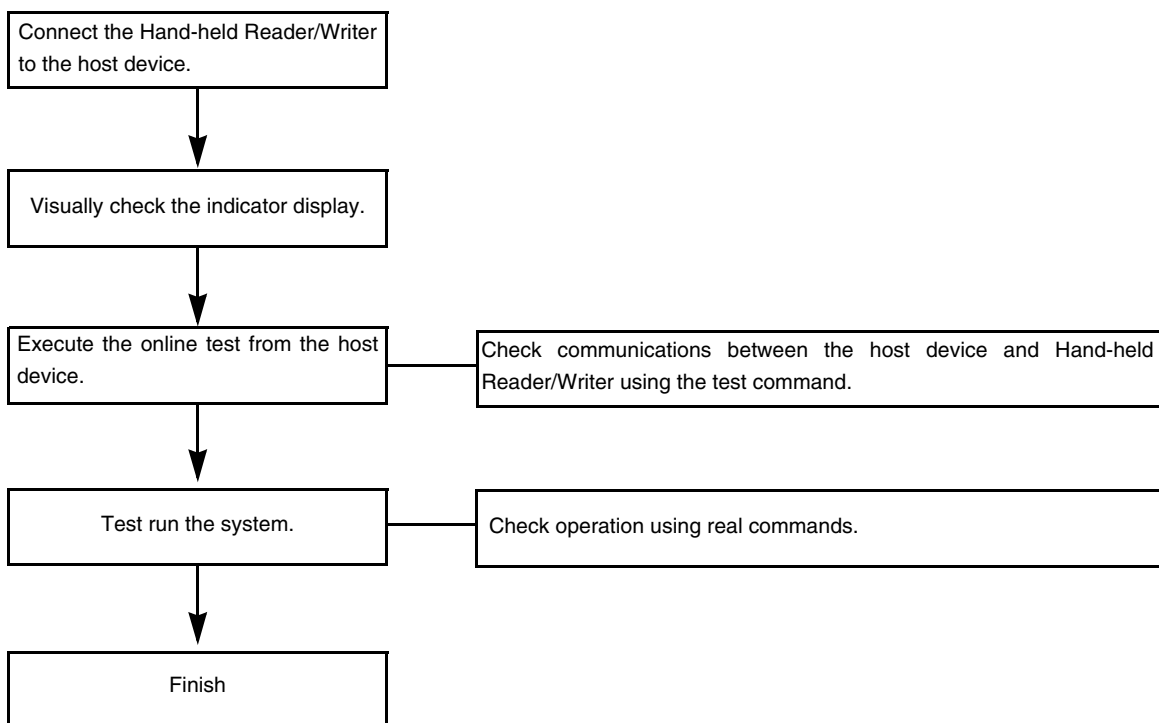

Communications Test between Host Device and Hand-held Reader/Writer

Use the test command to test communications between the Hand-held Reader/Writer and host device. Before performing communications with the RF Tag, check the Hand-held Reader/Writer connections and communications.

1. Send the test command from the host device.

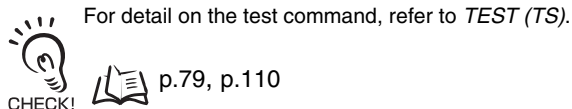

2. If communications is normal, the Hand-held Reader/Writer will return the received data.

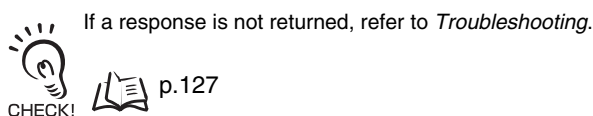

Communications Test between RF Tags and Hand-held Reader/Writer

Use actual commands to test communications between the RF Tags and the Hand-held Reader/Writer.

1. Send the READ command (RD) with an SA communications specification from the host device.

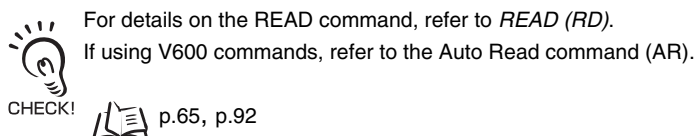

The Hand-held Reader/Writer will communicate with the RF Tag and the operation indicator will flash green.

2. Move the antenna of the Hand-held Reader/Writer close to the RF Tag.

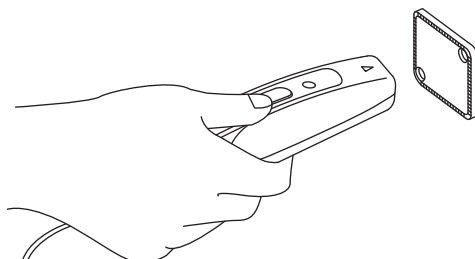

The Hand-held Reader/Writer will read the data in the RF Tag when the Hand-held Reader/Writer moves within the interrogation zone. As a result, the operation indicator will light green and then turn OFF.

Section 3

Commands

☒ Communicating with RF Tags	56
☒ V600 and V680 Command Comparison	57
☒ V680 Commands	59
☒ V600 Commands	83

Communicating with RF Tags

Specifying Data Code

Whether the read or write data is treated as an ASCII (or JIS 8) or hexadecimal is specified in each command.

ASCII (JIS 8 Code)

- One character of ASCII or JIS 8 code data occupies 1 byte (1 address) of the RF Tag memory.

• RF Tag

Address (hex)			
0010	4	F	"O"
0011	4	D	"M"
0012	5	2	"R"
0013	4	F	"O"
0014	4	E	"N"

1 byte

• Examples for Specifying ASCII Text

V600 Commands

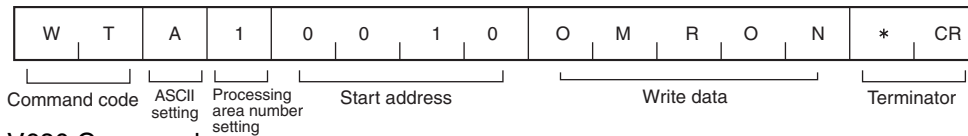

V680 Commands

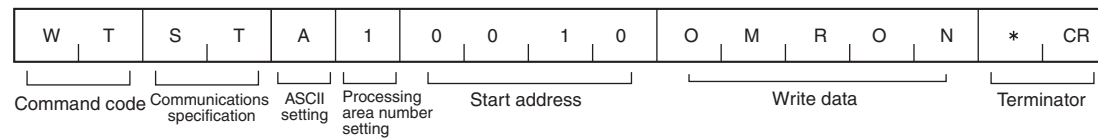

Hexadecimal

- One character is treated as a hexadecimal number. Therefore, only numerals 0 through 9 and A to F can be accepted.
- Two characters of data occupy 1 byte (1 address) of the RF Tag memory. Therefore, specify data in 2-character units (in even numbers) when using a WRITE command. If an odd number of characters is specified by mistake, an error will occur.

• RF Tag

Address (hex)			
0010	1	9	
0011	9	6	

1 byte

• Examples for Specifying Hexadecimal

V600 Commands

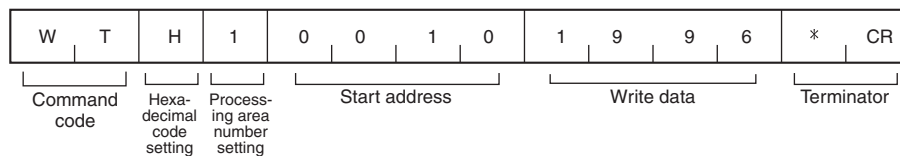

V680 Commands

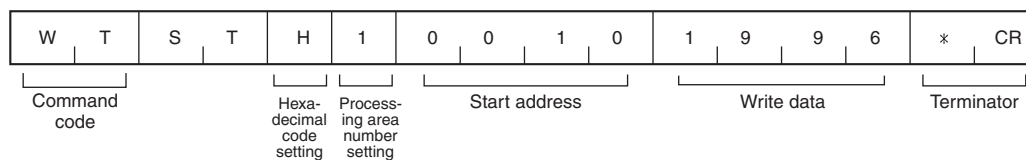

V600 and V680 Command Comparison

The V680-series Hand-held Reader/Writer can use commands in either the V600 command format or the V680 command format. By using V600 commands, production lines that previously used a V600-series Reader/Writer can use the same application with the V680-series Hand-held Reader/Writer. New functionality can be used by using V680 commands.

The PARAMETER SET (SP) command is used to switch between the two command formats. V680 and V600 commands are handled as shown in the following tables.

Communications Commands

V680 commands				V600 commands		
Command name	Command code	Communications specification	Data specification	Command name	Command code	Data specification
READ	RD	ST	A/H	READ	RD	A/H
		SA	A/H	AUTO READ	AR	A/H
		BT	A/H	BUTTON READ	BR	A/H
		BA	A/H	BUTTON AUTO READ	UR	A/H
WRITE	WT	ST	A/H	WRITE	WT	A/H
		SA	A/H	AUTO WRITE	AW	A/H
		BT	A/H	BUTTON WRITE	BW	A/H
		BA	A/H	BUTTON AUTO WRITE	UW	A/H
DATA FILL	DF	ST	A/H	DATA FILL	FL	A/H
		SA	A/H	AUTO DATA FILL	AF	A/H
DATA CHECK	MD	ST	C/K	DATA CHECK	MD	C/K
OVERWRITE COUNT CONTROL	MD	ST	S/L	OVERWRITE COUNT CONTROL	MD	S
CALCULATION WRITE	---	---	---	CALCULATION WRITE	CW	A/S
ID CODE READ	ID	ST	H	ID CODE READ	ID	H
READ WITH ERROR CORRECTION	QR	ST	A/H	---	---	---
WRITE WITH ERROR CORRECTION	QW	ST	A/H	---	---	---

Communications Subcommands

V680 commands			V600 commands		
Command name	Command code	Data specification	Command name	Command code	Data specification
COMMAND PROCESSING TERMINATE	AA	---	COMMAND PROCESSING TERMINATE	AA	---
ABORT (reset)	XZ	---	ABORT (reset)	XZ	---

Controller Control Commands

V680 commands		V600 commands	
Command name	Command code	Command name	Command code
COMMUNICATIONS CONDITIONS SETTING	TR	COMMUNICATIONS CONDITIONS SETTING	TR
BASIC FUNCTIONS SETTING	FN	BASIC FUNCTIONS SETTING	FN
SET INFORMATION READ	UL	SET INFORMATION READ	UL
PARAMETER SET	SP	PARAMETER SET	SP

Host Commands

V680 commands		V600 commands	
Command name	Command code	Command name	Command code
TEST	TS	TEST	TS
VERSION READ	VS	VERSION READ	VS

V680 Commands

Communications with the RF Tag

There are four types of communications specifications for communicating with RF Tags using the Hand-held Reader/Writer.

Name	Communications specification	Description
Single trigger	ST	When the Hand-held Reader/Writer receives a command, it communicates with an RF Tag and then returns a response.
Single auto	SA	When the Hand-held Reader/Writer receives a command, it waits to detect an RF Tag in the Antenna's communication area. When the Hand-held Reader/Writer detects an RF Tag, it communicates with the RF Tag and then returns a response.
Button trigger	BT	When the Hand-held Reader/Writer receives a command, it communicates with the RF Tag when the activate switch is pressed, and then returns a response.
Button auto	BA	When the Hand-held Reader/Writer receives a command, it waits to detect an RF Tag in the Antenna's communication area after the activate switch is pressed. When the Hand-held Reader/Writer detects an RF Tag, it communicates with the RF Tag and then returns a response.



Depending on the command, there are limitations on the communications specification that can be used. For communication specifications that can be used, refer to *V600 and V680 Command Comparison* in this chapter.



CHECK!

Single Trigger (ST) Communications Specifications

After the antenna end of the Hand-held Reader/Writer has been moved close to an RF Tag, a single trigger (ST) communications specification is sent from the host device to communicate with the RF Tag.

1. Move the antenna end of the Hand-held Reader/Writer close to the RF Tag.

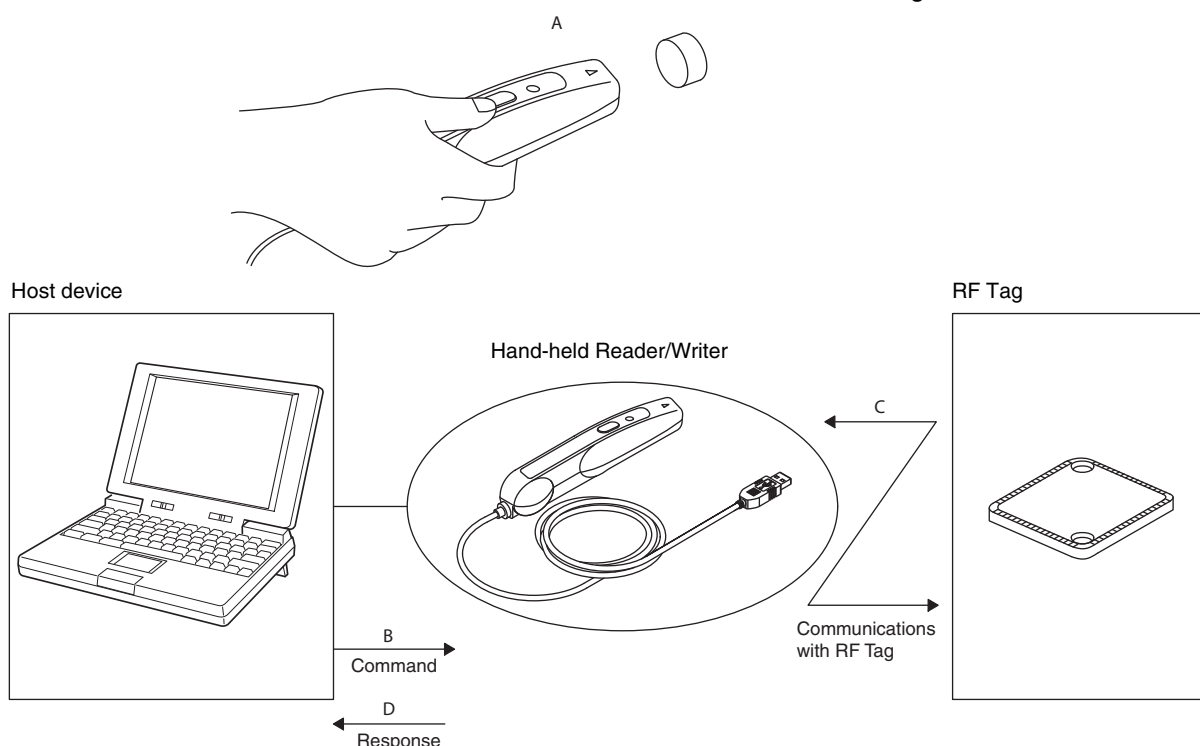

2. Send the command from the host device to the Hand-held Reader/Writer.
3. The Hand-held Reader/Writer will communicate with the RF Tag.
4. A response will be returned from the Hand-held Reader/Writer to the host device.
If communications end normally, the operation indicator (LED) will light green and then turn OFF. If an RF Tag is not detected within the Hand-held Reader/Writer's communication area when the command is sent from the host device, an RF Tag Non-existent Error will occur. At this time, the operation indicator will flash red.

Single Auto (SA) Communications Specifications

A single auto (SA) communications specification is used to communicate with an RF Tag when the antenna end of the Hand-held Reader/Writer is moved close to an RF Tag after the command has been sent from the host device.

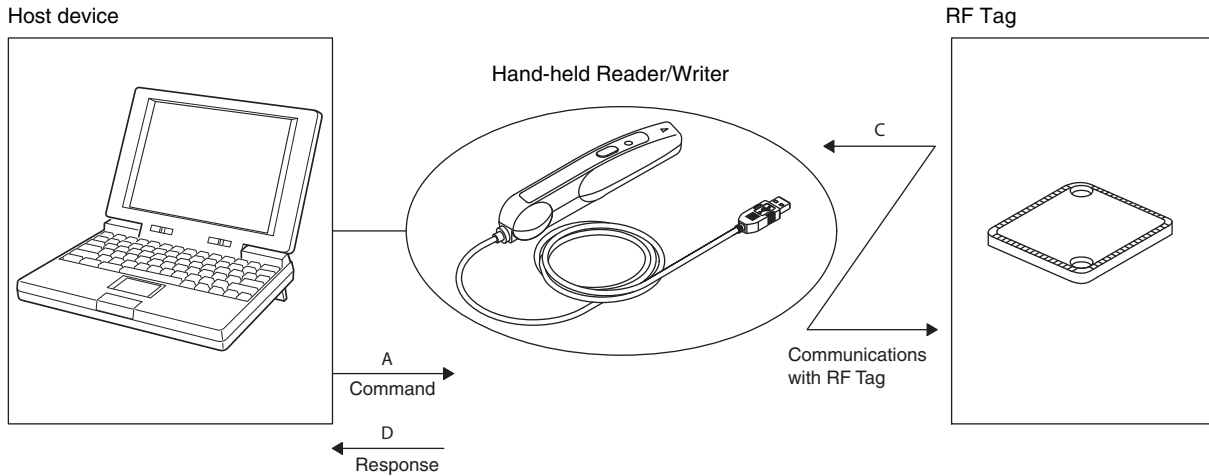

1. Send the command from the host device to the Hand-held Reader/Writer.
2. The Hand-held Reader/Writer will enter the communications stand-by state with the RF Tag, and the operation indicator (LED) will flash green.



If an RF Tag is not detected within one minute of sending the command, a timeout will occur and an RF Tag Non-existent Error will occur. As a result, the operation indicator will flash red.

CHECK!

3. Communications with the RF Tag will be performed when the antenna end of the Hand-held Reader/Writer is moved close to the RF Tag.

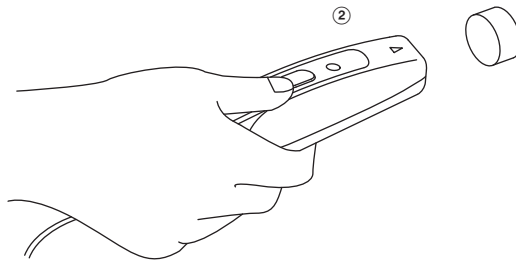

4. A response is returned from the Hand-held Reader/Writer to the host device.
If communications end normally, the operation indicator (LED) will light green and then turn OFF.

Button Trigger (BT) Communications Specifications

A button trigger (BT) communications specification is used to communicate with an RF Tag when the antenna is moved close to an RF Tag and the activate switch is pressed after the command has been sent from the host device.

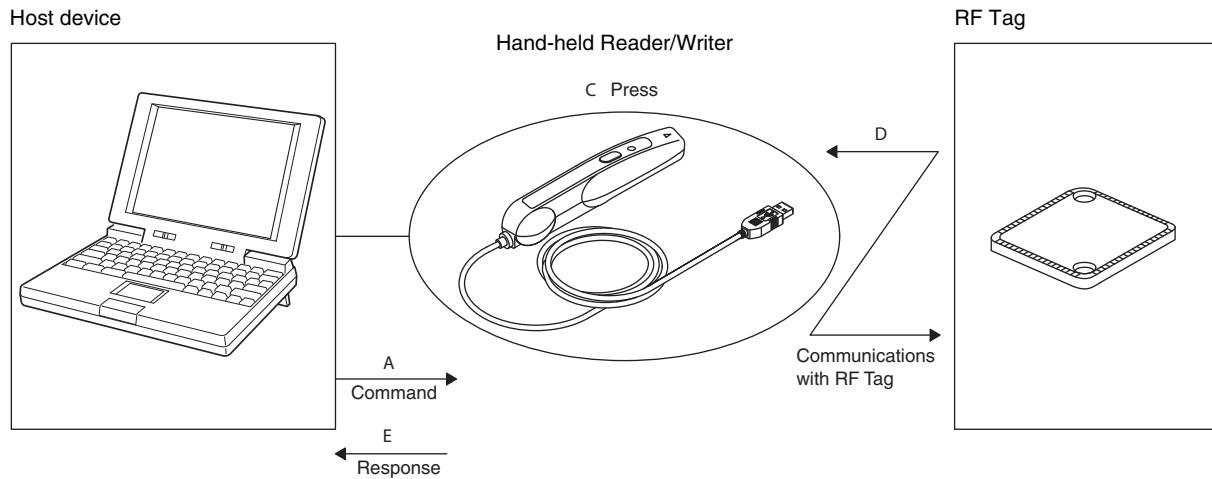

1. Send the command from the host device to the Hand-held Reader/Writer. The operation indicator will light green.
2. Move the antenna end of the Hand-held Reader/Writer close to the RF Tag.

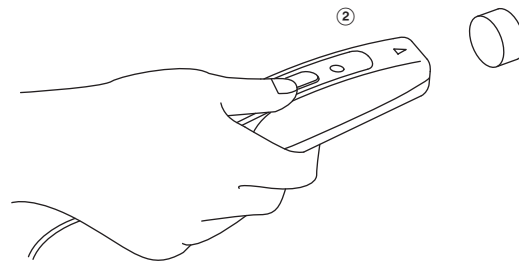

3. Press the Hand-held Reader/Writer activate switch.
4. The Hand-held Reader/Writer will communicate with the RF Tag.
5. A response is returned to the host device from the Hand-held Reader/Writer.
 - If communications end normally, the operation indicator (LED) will light green and then turn OFF.
 - If an RF Tag is not detected within the Hand-held Reader/Writer's communication area when the activate switch is pressed, an RF Tag Non-existent Error will occur. At this time, the operation indicator will flash red.

Button Auto (BA) Communications Specifications

A button auto (BA) communication specification is used to execute auto commands after the command is sent from the host device and the activate switch of the Hand-held Reader/Writer is pressed.

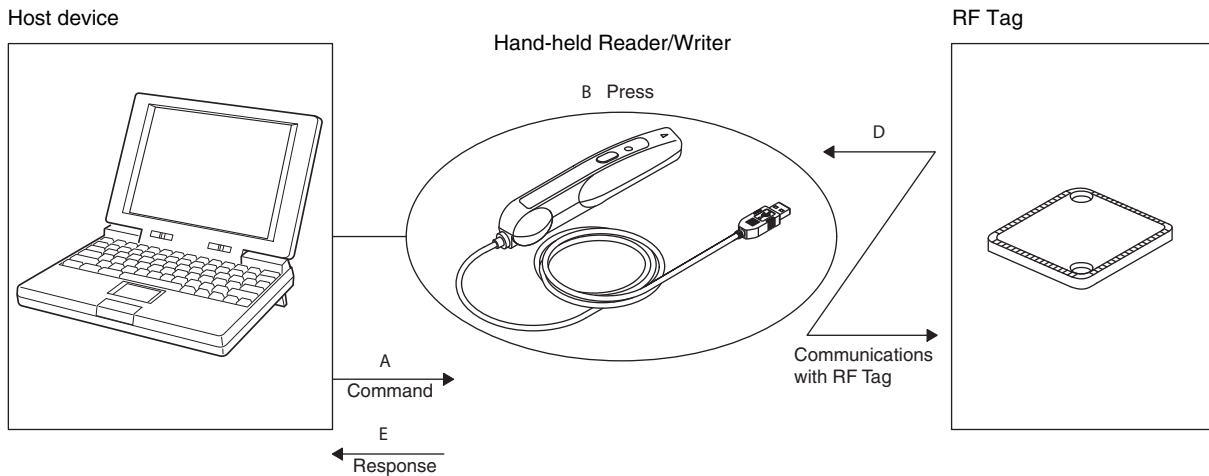

1. Send the command from the host device to the Hand-held Reader/Writer. The operation indicator will light green.
2. Press the Hand-held Reader/Writer activate switch.
3. The Hand-held Reader/Writer will enter the communication stand-by state with the RF Tag, and the operation indicator (LED) will flash green.



If the RF Tag is not detected within one minute of sending the command, a timeout will occur and an RF Tag Non-existent Error will occur. As a result, the operation indicator will flash red.

CHECK!

4. Communications with the RF Tag will be performed when the antenna end of the Hand-held Reader/Writer is moved close to an RF Tag.

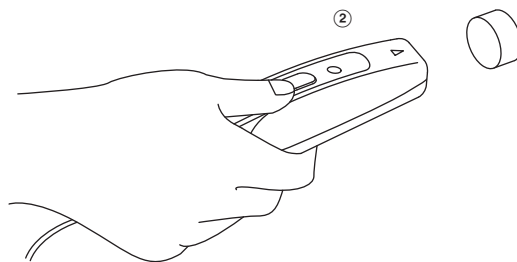

5. A response is returned from the Hand-held Reader/Writer to the host device.
If communications end normally, the operation indicator (LED) will light green and then turn OFF.

Command and Response Formats

The formats of commands sent from the host device to the Hand-held Reader/Writer and responses returned from the Hand-held Reader/Writer to the host device are described below.

The command and response both consist of a single frame. Each frame (including the terminator) consists of up to 2,114 characters. (When specifying hexadecimal for using the WRITE command, the maximum is 4,218 characters.)

Command Frame

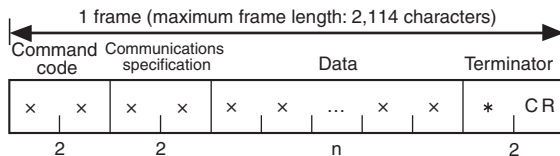

Name	Description
Command code	Contains the two-character code (see page 88) that indicates command.
Communications specification	Contains the two-character code that indicates the method used to communicate with the RF Tag (see page 59.)
Data	Contains the parameters or write data used to execute the command. <ul style="list-style-type: none"> • Data settings, processing specifications • Start address • Write data, number of bytes to be written • Number of read bytes • Number of check block bytes, decrement count • Specified data • Message data • Parameter data • Baud rate, data length, parity, and stop bit specifications • Auto command OFF specification • Settings for the TR command, settings for the FN command, and system setting data
Terminator	Indicates end of command/response.

Response Frame

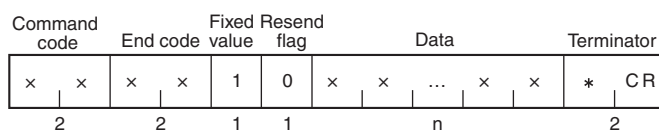

Name	Description
End code	Indicates the execution result for the command. For information on end codes, refer to <i>End Codes</i> .  p.82
Fixed value	Always 1.
Resend flag	Always 0.
Data	The data for the response. <ul style="list-style-type: none"> • Read data • UID • Processing terminate timing • Parameter data • Message data • Model information

Note: Other than the above items, the same data as the command frame is returned in the response.

Command List

Commands can be classified into four major types.

■ Communications Commands

The following commands are used for communications with the RF Tag.

Command code	Command name	Processing specification	Function	Page
RD	READ	A/H	Reads memory data from the RF Tag.	p.65
WT	WRITE	A/H	Writes data to the memory of the RF Tag.	p.66
DF	DATA FILL	A/H	Writes the specified data to the specified number of bytes beginning from the specified start address.	p.67
MD	DATA CHECK	C/K	Calculates or compares memory check codes in the RF Tag.	p.70
	OVERWRITE COUNT CONTROL	S/L	Controls the number of overwrites for RF Tags.	p.69
ID	ID CODE READ	H	Reads the UID in the RF Tag.	p.71
QR	READ WITH ERROR CORRECTION	A/H	Reads memory data from the RF Tag. Verifies data reliability using the check code.	p.72
QW	WRITE WITH ERROR CORRECTION	A/H	Writes data to the memory of the RF Tag. Writes a check code to enable verifying data reliability.	p.73

■ Communications Subcommands

The following commands are used to cancel or reset command execution.

Command code	Command name	Processing specification	Function	Page
AA	COMMAND PROCESSING TERMINATE	-	Forcedly ends communications with the RF Tag.	p.74
XZ	ABORT	-	Resets the Hand-held Reader/Writer.	p.74

■ Controller Control Commands

These commands are used to reset the Controller or set serial communications.

Command code	Command name	Function	Page
TR	COMMUNICATIONS CONDITIONS SETTING	Sets communications parameters for communications with the host device.	p.75
FN	BASIC FUNCTIONS SETTING	Sets the Auto Command OFF function.	p.76
UL	SET INFORMATION READ	Reads the settings data for the Hand-held Reader/Writer.	p.77
SP	PARAMETER SET	Sets, reads, or initializes Hand-held Reader/Writer parameters.	p.78

■ Host Commands

These commands are used to test communications between the Hand-held Reader/Writer and host device.

Command code	Command name	Function	Page
TS	TEST	Confirms the communications status between the Hand-held Reader/Writer and host device. The data sent from the host device is returned as is.	p.79
VS	VERSION READ	Reads the Hand-held Reader/Writer's software model, software version, and software creation date.	p.80

Communications Commands

Details of communications commands used to communicate with the RF Tag are provided here.

■ READ (RD)

This command reads up to 2 Kbytes of data from the RF Tag.

Command

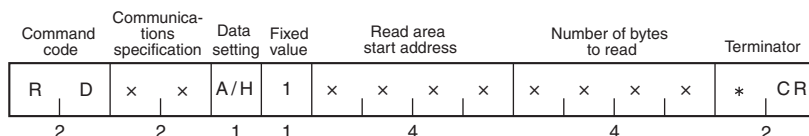

Communications specification	Specifies the method for communicating with the RF Tag. Refer to <i>Communications with the RF Tag</i> for details on the communications specification.  p.59
Data setting	Sets the code format used to send responses for read data. A: ASCII H: Hexadecimal
Fixed value	Always 1.
Read area start address	Specifies the start address of the area to be read from the RF Tag in 4-digit hexadecimal. Setting range: 0000 to FFFF hex
Number of bytes to read	Specifies the number of bytes to be read from the RF Tag in 4-digit hexadecimal. The maximum number of bytes that can be read at one time is 2 Kbytes, as follows: Setting range: 0001 to 0800 hex •ASCII: 2,048 bytes (2,048 characters) •Hexadecimal: 2,048 bytes (4,096 characters)

Response

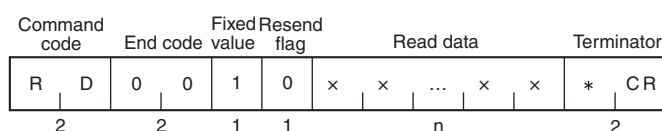

End code	Indicates the execution result for the command. The end code 00 indicates normal completion. For details on end codes, refer to <i>End Codes</i> .  p.82
Fixed value	Always 1.
Resend flag	Always 0.
Read data	Specifies the data read from the RF Tag. The characters in ASCII indicate the number of read bytes and the characters in hexadecimal indicate the number of read bytes x 2.

■ WRITE (WT)

The WRITE command writes up to 2 Kbytes of data to the memory of an RF Tag.

Command

Command code		Communications specification		Data setting	Fixed value	Write area start address				Write data				Terminator		
W	T	x	x	A/H	1	x	x	x	x	x	x	...	x	x	*	CR
2		2		1	1	4				n				2		

Communications specification	Specifies the method for communicating with the RF Tag. Refer to <i>Communications with the RF Tag</i> for details on the communications specification.  p.59
Data setting	Sets the code format used to send responses for read data. A: ASCII H: Hexadecimal
Fixed value	Always 1.
Write area start address	Specifies the start address of the area in the RF Tag to be written to in 4-digit hexadecimal. Setting range: 0000 to FFFF hex
Write data	Specifies the write data to the RF Tag. Up to 2 Kbytes of data can be written with one command. ASCII: 2,048 bytes (2,048 characters) Hexadecimal: 2,048 bytes (4,096 characters)

Response

Command code		End code		Fixed value	Resend flag	Terminator	
W	T	0	0	1	0	*	CR
2		2		1	1	2	

End code	Indicates the execution result for the command. The end code 00 indicates normal completion. For details on end codes, refer to <i>End Codes</i> .  p.82
Fixed value	Always 1.
Resend flag	Always 0.

Example

This examples shows how to write 00101 hex to the memory area with addresses 0030 to 0006 (hex) for an RF Tag in which the same data and address is written. The communications specification is ST.

Command

Command code		Communications specification		Data setting	Fixed value	Write area start address				Number of write bytes				Write data				Terminator	
D	F	S	T	H	1	0	0	3	0	0	0	0	6	0	1	0	1	*	CR
2		2		1	1	4				4				4				2	

Response

Command code		End code		Fixed value	Resend flag	Terminator	
D	F	0	0	1	0	*	CR
2		2		1	1	2	



Address (hex)	Before Writing	
	002F	2
0030	3	0
0031	3	1
0032	3	2
0033	3	3
0034	3	4
0035	3	5
0036	3	6

Address (hex)	Before Writing	
	002F	2
0030	0	1
0031	0	1
0032	0	1
0033	0	1
0034	0	1
0035	0	1
0036	3	6

OVERWRITE COUNT CONTROL (MD S/L)

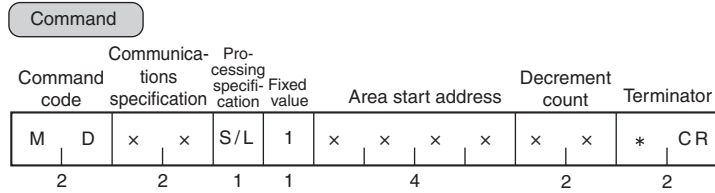
The OVERWRITE COUNT CONTROL command is used to manage overwrite counts for EEPROM RF Tags. The specified overwrite count control area data is updated to enable determining when the EEPROM's write life has expired.



Communications specification	Specifies the method for communicating with the RF Tag. For details on communications specifications, refer to <i>Communications with the RF Tag</i> .  p.59
Processing specification	Specifies the check process. S: Subtraction (Overwrite control count can be set by user. 16,700,000 writes max.) See note. L: Addition (Overwrite control count fixed at 100,000 writes.)
Fixed value	Always 1.
Area start address	Specifies the start address of the overwrite count control area in 4-digit hexadecimal. Setting range: 0000 to FFFD hex
Decrement count	Specifies the number of refresh operations in 2-digit hexadecimal. Setting range: 00 to FF hex (00 Performs overwrite count check only.) For details, refer to <i>RF Tag Service Life Detection</i> .  p.123

Note: The write life for EEPROM RF Tags is 100,000 at 25°C.

Response

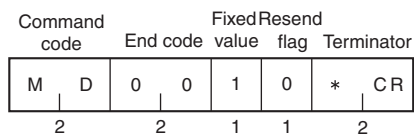

End code	Indicates the execution result for the command. The end code 00 indicates normal completion. For details on end codes, refer to <i>End Codes</i> .  p.82
Fixed value	Always 1.
Resend flag	Always 0.



For details on OVERWRITE COUNT CONTROL, refer to *RF Tag Service Life Detection*.



 p.123

DATA CHECK (MD C/K)

This command writes or compares the CRC code using the specified check block unit. The CRC code is calculated from the generated polynomial expression $X^{16} + X^{12} + X^5 + 1$.

Command

Command code		Communications specification		Pro-cessing speci-fication	Fixed value	Check block start address				Number of check block bytes		Terminator	
M	D	x	x	C/K	1	x	x	x	x	x	x	*	CR
2		2		1	1	4				2		2	

Communications specification	Specifies the method for communicating with the RF Tag. For details on communications specifications, refer to <i>Communications with the RF Tag</i> .  p.59
Process setting	Specifies the check process. K: Check code calculation C: Check code comparison
Fixed value	Always 1.
Check block start address	Specifies the start address of the check block in 4-digit hexadecimal. Setting range: 0000 to 1FFD hex
Number of check block bytes	Specifies the number of bytes in the check block in 2-digit hexadecimal. Setting range: 00h, 03 to FF hex (00 = 256 bytes) The number of check block bytes is the check code calculation area + 2 bytes. For details, refer to <i>Memory Check Function in RF Tag</i> .  p.125

Response

Command code		End code		Fixed value	Resend flag	Terminator	
M	D	0	0	1	0	*	CR
2		2		1	1	2	

End code	Indicates the execution result for the command. An end code of 00 indicates normal completion. For details on end codes, refer to <i>End Codes</i> .  p.82
Fixed value	Always 1.
Resend flag	Always 0.



For details on the memory check, refer to *Memory Check Function in RF Tag*.

 p.125

■ ID CODE READ (ID)

Reads the ID code from the RF Tag.

Command

Command code	Communications specification	Data setting	Fixed value	Terminator
I D	x x	H	1	* CR
2	2	1	1	2

Communications specification	Specifies the method for communicating with the RF Tag. For details on communications specifications, refer to <i>Communications with the RF Tag</i> .  p.59
Data setting	Always H.
Fixed value	Always 1.

Response

Command code	End code	Fixed value	Resend flag	UID	Terminator
I D	0 0	1	0	x x ... x x	* CR
2	2	1	1	0 or 16	2

End code	Indicates the execution result for the command. The end code 00 indicates normal completion. For details on end codes, refer to <i>End Codes</i> .  p.82
Fixed value	Always 1.
Resend flag	Always 0.
UID	The UID is an ID that uniquely identifies an RF Tag. (Unique Identifier) Note: A ID code will not be attached if an error occurs.



The ID READ command is used to write the ID code to the RF Tag's memory, and therefore will be affected by the ambient temperature. Be careful when using the RF Tag in environments with high ambient temperatures.

■ READ WITH ERROR CORRECTION (QR)

Reads the data in the area written by the WRITE WITH ERROR CORRECTION (QW) command from the RF Tag. Be sure to read data from the same area written by the WRITE WITH ERROR CORRECTION (QW) command.

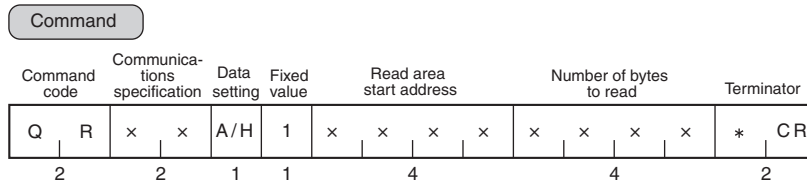

Communications specification	Specifies the method for communicating with the RF Tag. For details on communications specifications, refer to <i>Communications with the RF Tag</i> .  p.59
Data setting	Sets the code format used to send responses for read data. A: ASCII H: Hexadecimal
Fixed value	Always 1.
Read area start address	Specifies the start address of the area to be read from the RF Tag in 4-digit hexadecimal. Setting range: 0000 to FFFA hex
Number of bytes to read	Specifies the number of bytes to be read from the RF Tag in 4-digit hexadecimal. The maximum number of bytes that can be read at one time is 510 bytes, as follows: Setting range: 0001 to 01FE hex • ASCII: 510 bytes (510 characters) • Hexadecimal: 510 bytes (1,020 characters)



End code	Indicates the execution result for the command. The end code 00 indicates normal completion. For details on end codes, refer to <i>End Codes</i> .  p.82
Fixed value	Always 1.
Resend flag	Always 0.
Read data	Specifies the data read from the RF Tag. The characters in ASCII indicate the number of read bytes and the characters in hexadecimal indicate the number of read bytes x 2.

■ WRITE WITH ERROR CORRECTION (QW)

The WRITE WITH ERROR CORRECTION (QW) command writes data to the RF Tag. The command also writes the RF Tag memory check and error correction codes as 5 bytes of write data. Do not change this code, it is required by the READ WITH ERROR CORRECTION (QR) command.

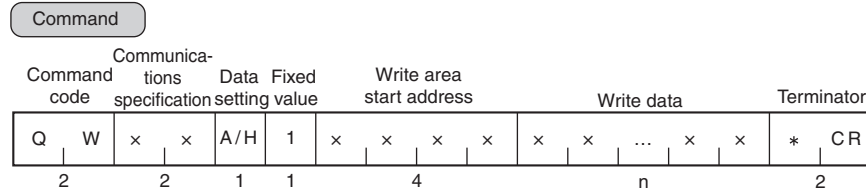

Communications specification	Specifies the method for communicating with the RF Tag. For details on communications specifications, refer to <i>Communications with the RF Tag</i> .  p.59
Data setting	Sets the code format used to send responses for write data. A: ASCII H: Hexadecimal
Fixed value	Always 1.
Write area start address	Specifies the start address of the area in the RF Tag to be written to in 4-digit hexadecimal. Setting range: 0000 to FFFA hex
Write data	Specifies the write data to the RF Tag. The maximum number of bytes that can be read at one time is 510 bytes, as follows: ASCII: 510 bytes (510 characters) Hexadecimal: 510 bytes (1,020 characters)

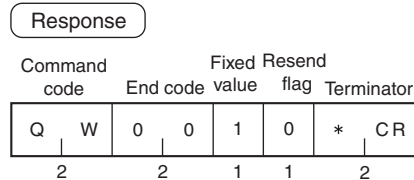

End code	Indicates the execution result for the command. The end code 00 indicates normal completion. For details on end codes, refer to <i>End Codes</i> .  p.82
Fixed value	Always 1.
Resend flag	Always 0.

Communications Subcommands

Communications subcommands are used together with communications commands. Communications with the RF Tag cannot be performed using only these subcommands.

■ COMMAND PROCESSING TERMINATE (AA)

Terminates the processing of the communications commands and restores the command wait status.

Command		Pro- cessing specifi- cation	Fixed value	Terminator
A	A	0	1	* CR
2	1	1	2	

Processing specification	Always 0.
Fixed value	Always 1.

Response		Command code	End code	Fixed value	Resend flag	Processing terminate timing	Terminator
A	A	0	0	1	0	0 x	* CR
2	2	1	1	2	2	2	2

End code	Indicates the execution result for the command. 00: Normal completion 15: Command processing not executed. For details on end codes, refer to <i>End Codes</i> .  p.82
Fixed value	Always 1.
Resend flag	Always 0.
Termination timing	Indicates the timing for terminating command processing. 00: Terminate before RF Tag detection. 01: Terminate during RF Tag detection.

■ ABORT (XZ)

This command is used to restore the Hand-held Reader/Writer to command wait status when there is no response from the Hand-held Reader/Writer due to some problem during communications with the host device or with an RF Tag.



The ABORT (XZ) command can be used only with the V680-CH1D.
Do not use it with the V680-CHUD.

CHECK!

Command		Command code	Terminator
X	Z	*	CR
2	2		

Response
None

■ COMMUNICATIONS CONDITIONS SETTING (TR)

This command is used to set serial communications parameters. The Hand-held Reader/Writer must be restarted to make the changes take effect.



The COMMUNICATIONS CONDITIONS SETTING (TR) command can be used only with the V680-CH1D.
Do not use it with the V680-CHUD.

CHECK!



A memory error will occur if the power supply is interrupted while parameters are being changed.

CHECK!

Command

Command code	Baud rate	Data length	Parity	Stop bits	Terminator
T R	x	x	x	x	* CR
2	1	1	1	1	2

Baud rate	Sets the baud rate. 0: 9,600 bps 1: 2,400 bps 2: 4,800 bps 3: 19,200 bps 4: 38,400 bps Default setting: 9,600 bps
Data length	Sets the data length. 0: 7 bits 1: 8 bits Default setting: 7 bits
Parity	Sets the parity. 0: Even parity 1: Odd parity 2: No parity Default setting: Even parity
Stop bits	Sets the number of stop bits. 0: 2 bits 1: 1 bit Default setting: 2 bits

Response

Command code	End code	Fixed value	Resend flag	Terminator
T R	0 0	1	0	* CR
2	2	1	1	2

End code	Indicates the execution result for the command. 00: Normal completion For details on end codes, refer to <i>End Codes</i> . p.82
Fixed value	Always 1.
Resend flag	Always 0.

■ BASIC FUNCTIONS SETTING (FN)

This command is used to set the Auto Commands OFF function. The Hand-held Reader/Writer must be restarted to make the changes take effect.



A memory error will occur if the power supply is interrupted while parameters are being changed.

CHECK!

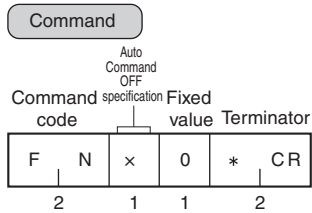

Auto Command OFF specifications	Designates whether the Auto Command OFF function is used. 0: Auto Command OFF used. 1: Auto Command OFF not used. Default setting: Auto Command OFF used.
Fixed value	Always 0.

Response



End code	Indicates the execution result for the command. 00: Normal completion For details on end codes, refer to <i>End Codes</i> . p.82
Fixed value	Always 1.
Resend flag	Always 0.

■ SET INFORMATION READ (UL)

This command is used to read the settings of the Hand-held Reader/Writer.



Only the Auto Command OFF function is supported by the V680-CHUD.

The settings made with the COMMUNICATIONS CONDITIONS SETTING (TR) command are not valid for the V600-CHUD.

CHECK!

Command

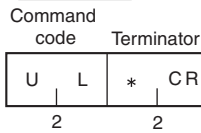

Response

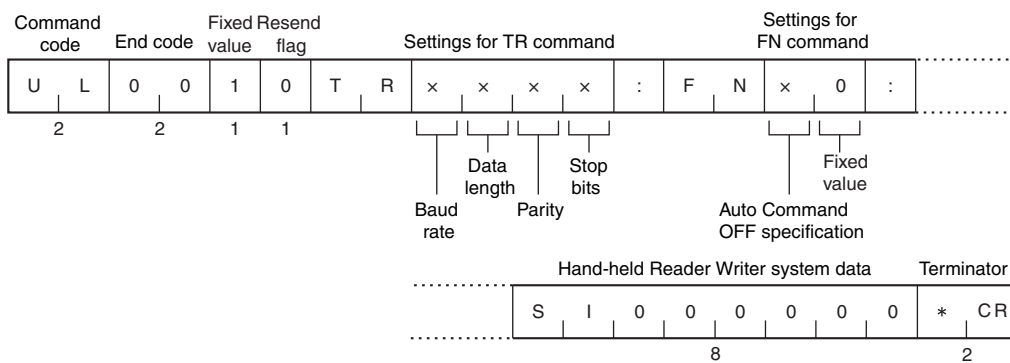

End code	Indicates the execution result for the command. 00: Normal completion For details on end codes, refer to <i>End Codes</i> . p.82	
Fixed value	Always 1.	
Resend flag	Always 0.	
Settings for TR command	Baud rate	0: 9,600 bps 1: 2,400 bps 2: 4,800 bps 3: 19,200 bps 4: 38,400 bps
	Data length	0: 7 bits 1: 8 bits
	Parity	0: Even parity 1: Odd parity 2: No parity
	Stop bits	0: 2 bits 1: 1 bit
Settings for FN command	Auto Command OFF Specification	0: Auto Command OFF used. 1: Auto Command OFF not used.
	Fixed value	Always 0.
System data	SI000000	

PARAMETER SET (SP)

The PARAMETER SET command is used to set conditions for communicating with RF Tags. The various parameters are set in the Hand-held Reader/Writer.



The Hand-held Reader/Writer does not need to be reset when internal settings are changed. The new settings are effective immediately.

CHECK!



A memory error will occur if the power supply is interrupted while parameters are being changed.

CHECK!

Command

Command code	Process code		Parameter data (for changed parameters only)				Terminator	
S	P	x	x	x	x	x	* CR	
2	2	Upper digit	Lower digit	0 to 4				2

Process code (Upper digit)	Specifies the process to perform for the parameter. 0: Change the internal setting. 1: Read internal setting. 9: Return internal setting to default value.	
Process code (Lower digit)	Specifies the parameter. 1: Inter-character monitoring time 2: Response delay time 4: Auto command cancel time H: Write protection setting J: Protocol switch L: Tag memory setting (See note 1.)	
Parameter data (for changed parameters only)	Data No. (See note 2.)	Settable values
	1	Specify 4 decimal digits. 0000 to 9999 (ms) 0000: No monitoring, Default value: 0100 (ms)
	2	Specify 2 decimal digits. 00 to 99 (ms) 00: No delay, Default value: 20 (ms)
	4	Specify 2 decimal digits. 01 to 99 (s) Default value: 60 (s)
	H	00: Write protection OFF 01: Write protection ON (default value)
	J	00: V600 protocol (default value) 01: V680 protocol
	L	00: Standard Mode (default value) 01: CA1D Mode

Note 1.: Parameter L is enabled only with version 1.1 or newer.

Note 2.: The data number of the parameter data is the number specified for the lower digit of the process code.

The settable values for the data number are the same as for the parameter specified by the lower digit of the process code.

Response

Command code	End code value	Fixed value	Resend flag	Parameter data				Terminator		
S	P	0	0	1	0	x	x	x	x	* CR
2	2	1	1	0 to 4				2		

End code	Indicates the execution result for the command. 00: Normal completion For details on end codes, refer to <i>End Codes</i> . p.82
Fixed value	Always 1.
Resend flag	Always 0.
Parameter data	Attached only when parameter data is being obtained.

Host Commands

TEST (TS)

This command returns test messages sent from the host device without changing anything.

The TEST command is used for communications tests between the host device and the Hand-held Reader/Writer.

Command

Command code		Message data					Terminator	
T	S	x	x	x	...	x	*	CR
2		n					2	

Message data	Any text string for testing communications containing 514 characters max.
--------------	---

Response

Command code		End code value		Fixed value	Resend flag	Message data					Terminator	
T	S	0	0	1	0	x	x	x	...	x	*	CR
2		2		1	1	n					2	

End code	Indicates the execution result for the command. 00: Normal completion For details on end codes, refer to <i>End Codes</i> .  p.82
Fixed value	Always 1.
Resend flag	Always 0.
Message data	Any text string for testing communications containing 514 characters max.

■ VERSION READ (VS)

The VERSION READ command reads the Hand-held Reader/Writer's software model, software version, and software creation date.

Command

Command code Terminator

V	S	*	CR
2	2	2	2

Response

Command code	End code	Fixed value	Resend flag					Terminator				
V	S	0	0	1	0	Software model	:	Software version	:	Creation date	*	CR
2	2	1	1	16	1	4	1	10	2			

Software model	The software creation date. For the V680-CHUD: V680-CHUD\$000000 For the V680-CH1D: V680-CH1D\$000000 For the V680-CH1D-PSI: V680-CH1D\$000000
Software version	The software version. *. **
Software creation date	The software creation date. 20**/**/**

Other Commands

■ UNDEFINED COMMAND RESPONSE (IC)

This command is returned as the response when the Hand-held Reader/Writer cannot read the command header.

Response

Command code		End code		Fixed Resend value	Fixed Resend flag	Terminator	
I	C	x	x	1	0	*	CR
2		2		1	1	2	

■ Error Response

If an error occurs during communications with the host device, or the RF Tag, error notification is provided in the end code.

Response

Command code		End code		Fixed Resend value	Fixed Resend flag	Terminator	
x	x	x	x	1	0	*	CR
2		2		1	1	2	

End Codes

End codes are given in 2-digit hexadecimal.

Status	End code	Meaning
Normal	00	Normal completion
Host communications error	10 (See note.)	Vertical parity error
	11 (See note.)	Framing error
	12 (See note.)	Overrun error
	14	Format error
	15	Execution status error
	18	Frame length error
Lower communications error	70	RF Tag communications error
	71	Mismatch error
	72	RF Tag non-existent error
	76	Error end code for the DATA CHECK command or OVERWRITE COUNT CONTROL command (verification error or overwrite count exceeded) or error for READ WITH ERROR CORRECTION or DATA CHECK command
	77	Warning for READ WITH ERROR CORRECTION or DATA CHECK command
	79	RF Tag error
	7A	Address error
	7C	Antenna error
	7D	Write protection error
Memory error	93	Internal memory error

Note: Vertical parity errors, framing errors, and overrun errors do not occur for the V680-CHUD.



For details on each error, refer to *Error Tables*.

CHECK!



p.128

V600 Commands

There are 4 types of commands for communicating with the RF Tag using the Hand-held Reader/Writer.

- Normal commands
- Button commands
- Auto commands
- Button auto commands

Normal Commands

Normal commands are sent from the host device for communications with the RF Tag, after the antenna end of the Hand-held Reader/Writer has been moved close to the RF Tag.

1. Move the antenna end of the Hand-held Reader/Writer close to the RF Tag.

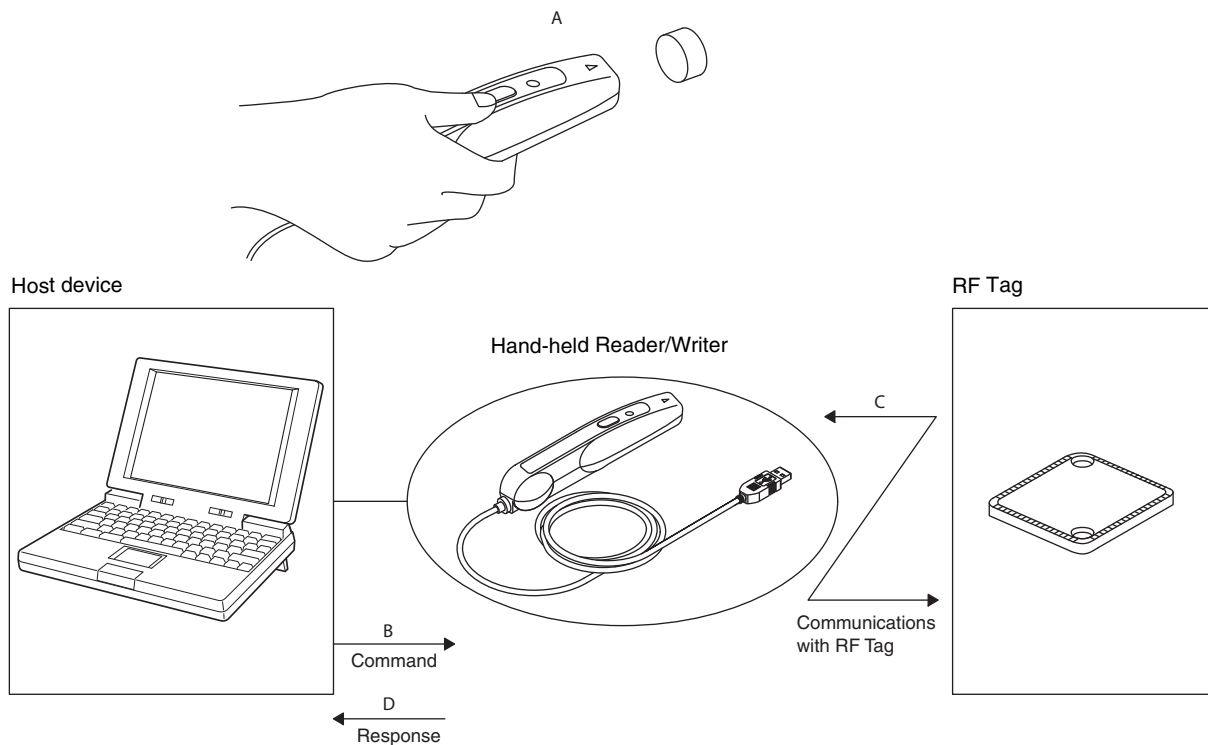

2. Commands are sent from the host device to the Hand-held Reader/Writer.
3. The Hand-held Reader/Writer communicates with the RF Tag.
4. A response is returned from the Hand-held Reader/Writer to the host device.

If communications end normally, the operation indicator (LED) will light green and then turn OFF.

If the RF Tag is not detected within the Hand-held Reader/Writer's communication area when the command is sent from the host device, an RF Tag Non-existent Error will occur.

At this time, the operation indicator will flash red.

Button Commands

Button commands used to perform communications with the RF Tag are activated when the activate switch is pressed after commands are sent from the host device, and the antenna end of the Hand-held Reader/Writer has been moved close to the RF Tag.

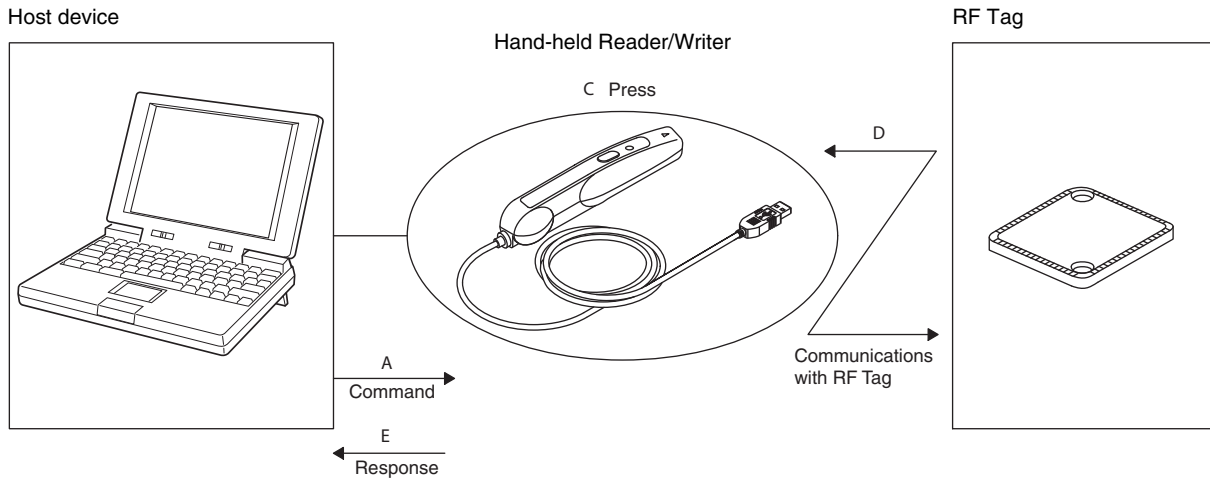

1. A command is sent from the host device to the Hand-held Reader/Writer. As a result, the operation indicator will light green.
2. Move the antenna end of the Hand-held Reader/Writer close to the RF Tag.

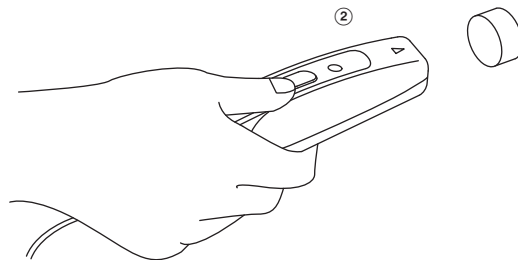

3. Press the Hand-held Reader/Writer activate switch.
4. The Hand-held Reader/Writer communicates with the RF Tag.
5. A response is returned to the host device from the Hand-held Reader/Writer.

If communications end normally, the operation indicator (LED) will light green and then turn OFF.

If the RF Tag is not detected within the Hand-held Reader/Writer's communication area when the activate switch is pressed, an RF Tag Non-existent Error will occur.

At this time, the operation indicator will flash red.

Auto Commands

Auto commands can execute communications with the RF Tag when the antenna end of the Hand-held Reader/Writer has been moved close to the RF Tag after the command is sent from the host device.

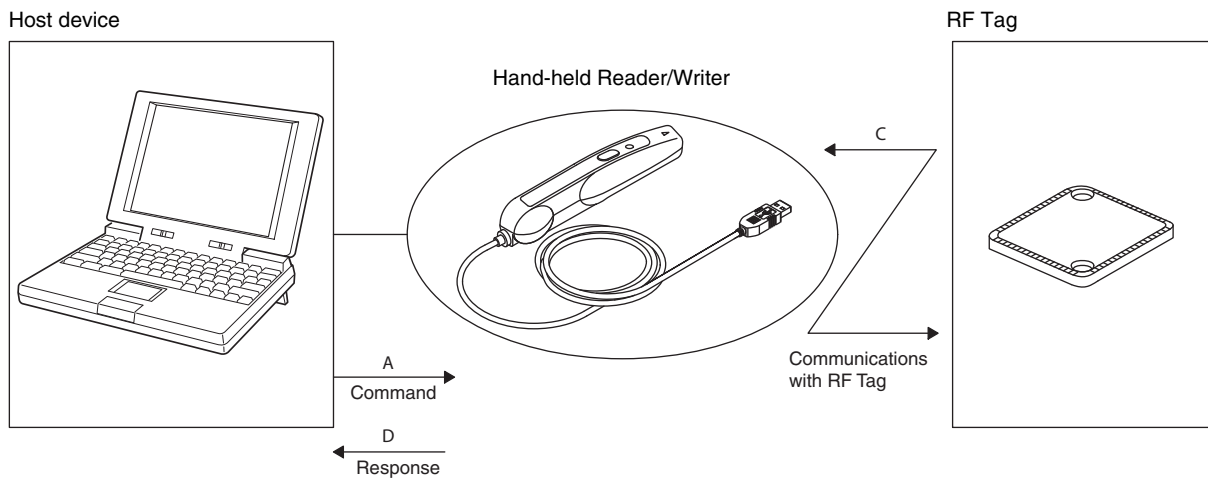

1. A command is sent from the host device to the Hand-held Reader/Writer.
2. The Hand-held Reader/Writer enters the communications stand-by state with the RF Tag, and the operation indicator (LED) flashes green.



If the RF Tag is not detected within one minute of sending the command, a timeout will occur and an RF Tag Non-existent Error will occur. As a result, the operation indicator will flash red.

3. Communications with the RF Tag are performed when the antenna end of the Hand-held Reader/Writer is moved close to the RF Tag.

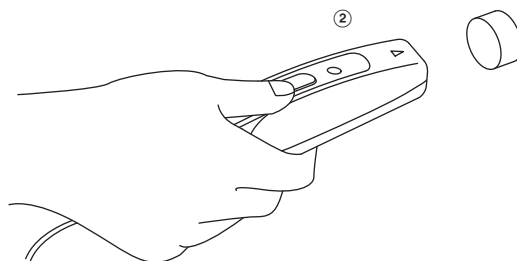

4. A response is returned to the host device from the Hand-held Reader/Writer.
If communications end normally, the operation indicator (LED) will light green and then turn OFF.

Button Auto Commands

Button auto commands execute auto commands after a command is sent from the host device and the activate switch of the Hand-held Reader/Writer is pressed.

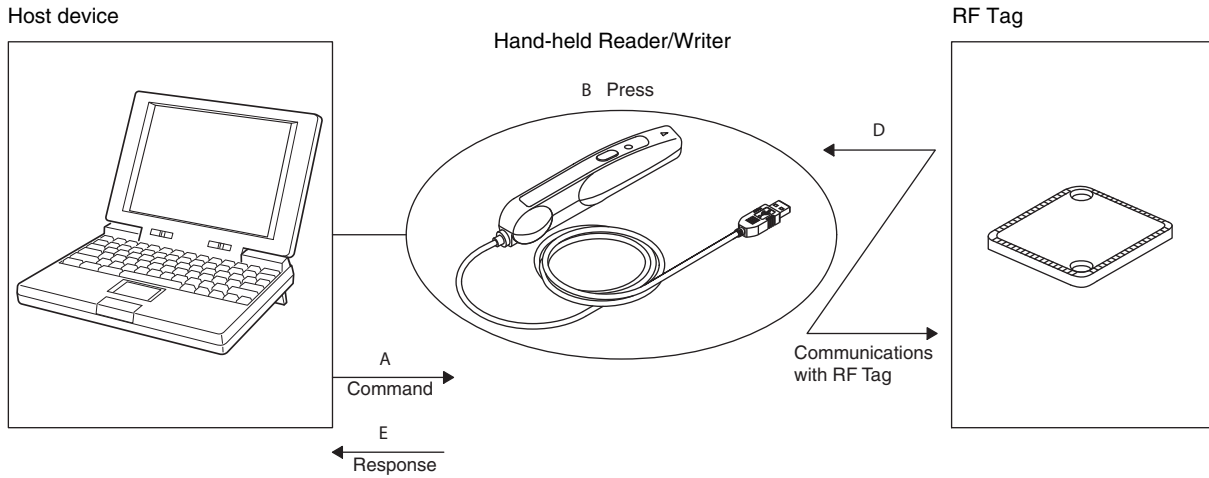

1. A command is sent from the host device to the Hand-held Reader/Writer. As a result, the operation indicator will light green.
2. Press the Hand-held Reader/Writer activate switch.
3. The Hand-held Reader/Writer enters the communications stand-by state with the RF Tag, and the operation indicator (LED) flashes green.



If the RF Tag is not detected within one minute of sending the command, a timeout will occur and an RF Tag Non-existent Error will occur. As a result, the operation indicator will flash red.

CHECK!

4. Communications with the RF Tag are performed when the antenna end of the Hand-held Reader/Writer is moved close to the RF Tag.

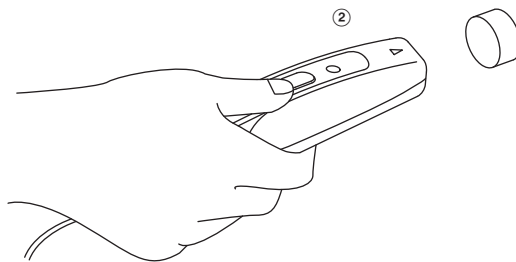

5. A response is returned to the host device from the Hand-held Reader/Writer.
If communications end normally, the operation indicator (LED) will light green and then turn OFF.

Command and Response Formats

The formats of commands sent from the host device to the Hand-held Reader/Writer and responses returned from the Hand-held Reader/Writer to the host device are described below.

The command and response both consist of a single frame. The frame (including the terminator) consists of up to, 2,114 characters.

Command Frame

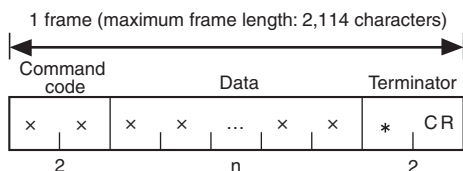

Name	Description
Command code	Contains the two-character code (see page 88) that indicates the command.
Data	Contains the data for the command. <ul style="list-style-type: none"> • Data setting, processing specification • Start address • Write data, number of bytes to be written • Number of read bytes • Number of calculation area bytes, calculation data • Number of check block bytes, decrement count • Specified data • Message data • Parameter data • Baud rate, data length, parity, and stop bits specification • Auto command OFF specification • Settings for the TR command, settings for the FN command, and system setting data.
Terminator	Indicates end of command/response.

Response Frame

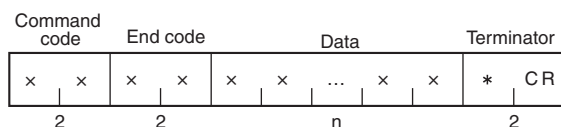

Name	Description
End code	Indicates the execution result for the command. For information on end codes, refer to <i>End Codes</i> .  p.82
Fixed value	Always 1.
Resend flag	Always 0.
Data	Contains the data for the response. <ul style="list-style-type: none"> • Read data • UID • Processing terminate timing • Calculation data • Message data • Parameter data • Model information

Note: Other than the above items, the same data as the command frame is returned in the response.

Command List

Commands can be classified into four major types.

■ Communications Commands

The following commands are used for communications with the RF Tag.

Command code	Command name	Function	Page
RD	READ	Reads memory data from the RF Tag.	p.89
WT	WRITE	Writes data to the memory of the RF Tag.	p.91
AR	AUTO READ	Reads data from the RF Tag when the RF Tag enters the interrogation zone.	p.92
AW	AUTO WRITE	Writes data to the memory of the RF Tag when the RF Tag enters the interrogation zone.	p.94
BR	BUTTON READ	Reads data from the memory of the RF Tag when the activate switch is pressed.	p.96
BW	BUTTON WRITE	Writes data to the memory of the RF Tag when the activate switch is pressed.	p.98
UR	BUTTON AUTO READ	Reads data from the RF Tag when the RF Tag enters the interrogation zone after the activate switch is pressed.	p.99
UW	BUTTON AUTO WRITE	Writes data to the memory of the RF Tag when the RF Tag enters the interrogation zone after the activate switch is pressed.	p.101
CW	CALCULATION WRITE	Writes the calculation results for the memory data to the RF Tag.	p.102
FL	DATA FILL	Writes data for the specified number of write bytes beginning from the write start address specified in the command.	p.103
AF	AUTO DATA FILL	Writes the specified data to the specified number of bytes beginning from the specified start address when the RF Tag approaches.	p.104
MDC/K	DATA CHECK	Calculates or compares memory check codes in the RF Tag.	p.106
MDS	OVERWRITE COUNT CONTROL	Controls the number of overwrites for RF Tags.	p.107
ID	ID CODE READ	Reads the UID in the RF Tag.	p.108

■ Communications Subcommands

These commands are used to cancel command execution.

Command code	Command name	Function	Page
AA	COMMAND PROCESSING TERMINATE	Forcedly ends communications with the RF Tag.	p.109
XZ	ABORT	Resets the Hand-held Reader/Writer.	p.112

■ Controller Control Commands

These commands are used to reset the Controller or set serial communications.

Command code	Command name	Function	Page
TR	COMMUNICATIONS CONDITIONS SETTING	Sets communications parameters for communications with the host device.	p.113
FN	BASIC FUNCTIONS SETTING	Sets the Specify Auto Command OFF function.	p.114
UL	SET INFORMATION READ	Reads the settings data for the Hand-held Reader/Writer.	p.115
SP	PARAMETER SET	Sets, reads, or initializes Hand-held Reader/Writer parameters.	p.116

■ Host Commands

These commands are used to test communications between the Hand-held Reader/Writer and host device.

Command code	Command name	Function	Page
TS	TEST	Confirms the communications status between the Hand-held Reader/Writer and host device. The data sent from the host device is returned as is.	p.110
VS	VERSION READ	Reads the Hand-held Reader/Writer's software model, software version, and software creation date.	p.111

Communications Commands

Details of communications commands used to communicate with the RF Tag are provided here.

■ READ (RD)

This command reads data from the RF Tag. If the RF Tag is not in the interrogation zone, an error response (end code: 72 = RF Tag non-existent) will be returned.

Command

Processing area number: 1

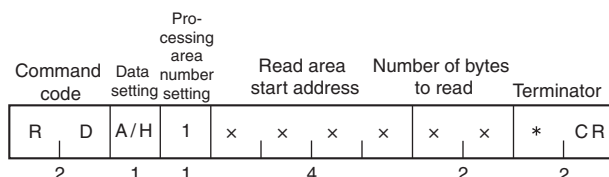

Processing area number: 2

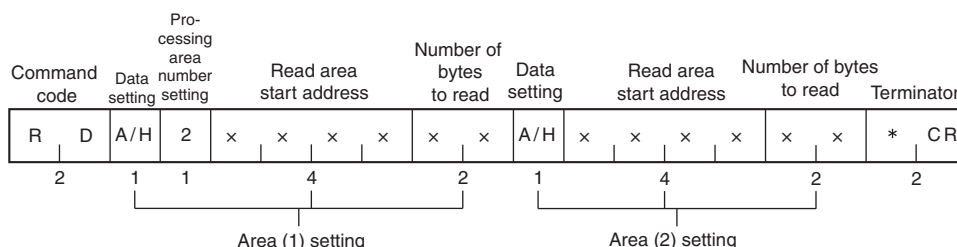

Data setting	<p>Sets the code format used to send responses for read data.</p> <p>A: ASCII H: Hexadecimal</p> <p>When multiple processing areas are used, ASCII and hexadecimal can be specified at the same time within a single command frame.</p>
Processing area number setting	<p>Specifies the processing area number.</p> <p>Setting range: 1 to 9, A (A = 10)</p>
Read area start address	<p>Specifies the start address of the area to be read from the RF Tag in 4-digit hexadecimal.</p> <p>Setting range: 0000 to FFFF hex</p> <p>When multiple processing areas are used, specify the areas in order starting from the smallest address. The same area cannot be specified twice.</p>
Number of bytes to read	<p>Specifies the number of bytes to be read from the RF Tag in 2-digit hexadecimal. The maximum number of bytes that can be read at one time is 256 bytes, as follows:</p> <ul style="list-style-type: none"> • ASCII: 256 bytes (256 characters) • Hexadecimal: 256 bytes (512 characters) <p>Setting range: 00 to FF hex (00 = 256 bytes)</p> <p>When multiple processing areas are used, set so that the total number of bytes from all areas to be read is within 256 bytes, as follows: Area (1) bytes +...+ Area (N) bytes ≤ 256 bytes</p>

Response

Processing Area Number: 1

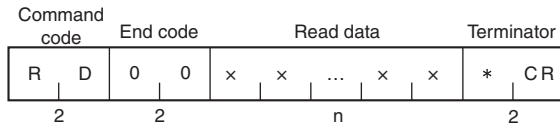

Processing Area Number: 2

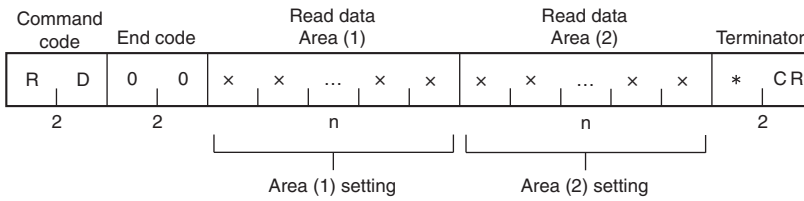

End code	<p>Indicates the execution result for the command. The end code 00 indicates normal completion.</p> <p>For details on end codes, refer to <i>End code List</i>.  p.118</p>
Read data	<p>Specifies the data read from the RF Tag. The characters in ASCII indicate the number of read bytes and the characters in hexadecimal indicate the number of read bytes x 2.</p>

WRITE (WT)

This command writes data to the RF Tag. If the RF Tag is not in the interrogation zone, an error response (end code: 72 = RF Tag non-existent) will be returned.

Command

Processing Area Number: 1

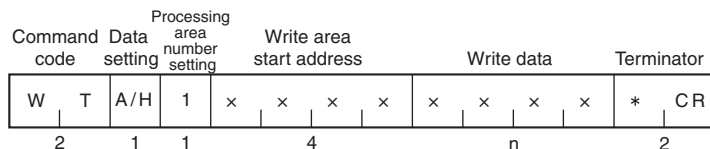

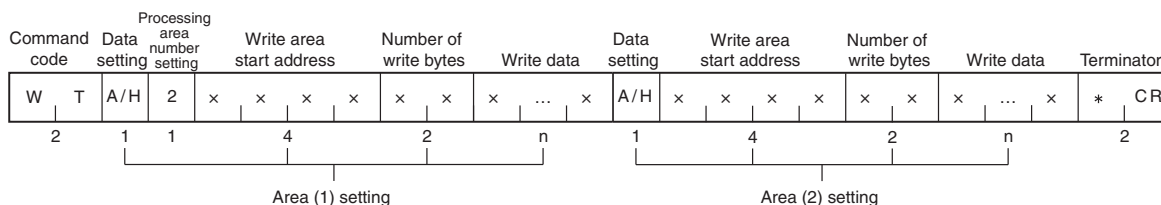

Processing Area Number: 2

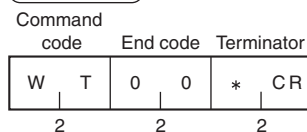

Data setting	<p>Sets the code format used to send responses for write data.</p> <p>A: ASCII H: Hexadecimal</p> <p>When multiple processing areas are used, ASCII and hexadecimal can be specified at the same time within a single command frame.</p>
Processing area number setting	<p>Specifies the processing area number.</p> <p>Setting range: 1 to 9, A (A = 10)</p>
Write area start address	<p>Specifies the start address of the area in the RF Tag to be written to in 4-digit hexadecimal.</p> <p>Setting range: 0000 to FFFF hex</p> <p>When multiple processing areas are used, specify the areas in order starting from the smallest address. The same area cannot be specified twice.</p>
Number of write bytes	<p>When multiple processing areas are used, specifies the number of bytes to be written to the RF Tag in 2-digit hexadecimal. The maximum number of bytes that can be written at one time is 256 bytes, as follows:</p> <ul style="list-style-type: none"> • ASCII: 256 bytes (256 characters) • Hexadecimal: 256 bytes (512 characters) <p>Setting range: 01 to FF hex</p> <p>When multiple processing areas are used, set so that the total number of bytes to be written for all areas is within 256 bytes, as follows: Area (1) bytes +...+ Area (N) bytes ≤ 256 bytes</p>
Write data	<p>Specifies the write data from the RF Tag.</p> <p>The characters in ASCII indicate the number of write bytes and the characters in hexadecimal indicate the number of write bytes x 2.</p>

Response



End code	<p>Indicates the execution result for the command.</p> <p>The end code 00 indicates normal completion.</p> <p>For details on end codes, refer to <i>End code List</i>.</p> <p> p.118</p>
----------	---

■ AUTO READ (AR)

This command reads data from the RF Tag when the RF Tag enters the interrogation zone. The Hand-held Reader/Writer responds when the communications between the Hand-held Reader/Writer and RF Tag have ended.

Command

Processing Area Number: 1

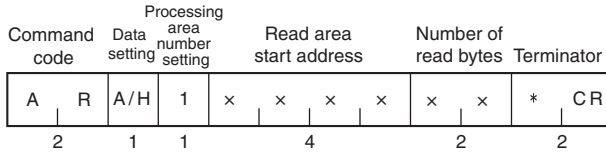

Processing Area Number: 2

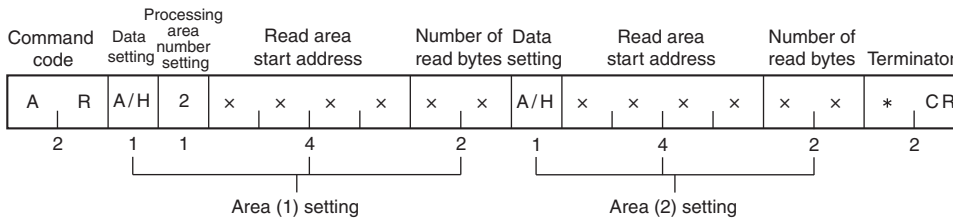

Data setting	Specifies the code format used to send responses for write data. A: ASCII H: Hexadecimal When multiple processing areas are used, ASCII and hexadecimal can be specified at the same time within a single command frame.
Processing area number setting	Specifies the processing area number. Setting range: 1 to 9, A (A = 10)
Read area start address	Specifies the start address of the area in the RF Tag to be read from in 4-digit hexadecimal. Setting range: 0000 to FFFF hex When multiple processing areas are used, specify the areas in order starting from the smallest address. The same area cannot be specified twice.
Number of read bytes	When multiple processing areas are used, specifies the number of bytes to be read from the RF Tag in 2-digit hexadecimal. The maximum number of bytes that can be read at one time is 256 bytes. • ASCII: 256 bytes (256 characters) • Hexadecimal: 256 bytes (512 characters) Setting range: 00 to FF hex (00 = 256 bytes) When multiple processing areas are used, set so that the total number of bytes to be read for all areas is within 256 bytes, as follows: Area (1) bytes +...+ Area (N) bytes ≤ 256 bytes

Response

Processing Area Number: 1

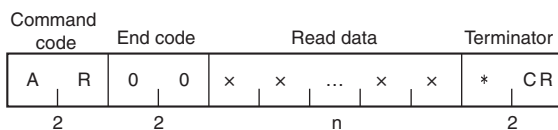

Processing Area Number: 2

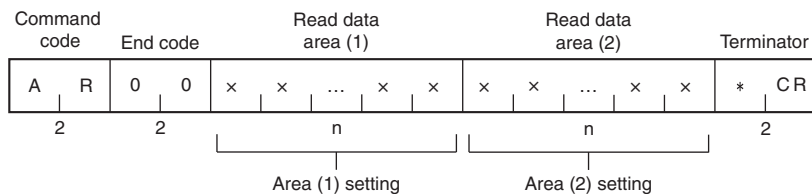

End code	<p>Indicates the execution result for the command. The end code 00 indicates normal completion.</p> <p>For details on end codes, refer to <i>End code List</i>.  p.118</p>
Read data	<p>Specifies the data read from the RF Tag. The characters in ASCII indicate the number of read bytes and the characters in hexadecimal indicate the number of read bytes x 2.</p>

■ AUTO WRITE (AW)

This command writes data to the RF Tag when the RF Tag enters the interrogation zone. The Hand-held Reader/Writer responds when communications between the Hand-held Reader/Writer and RF Tag have ended.

Command

Processing Area Number: 1

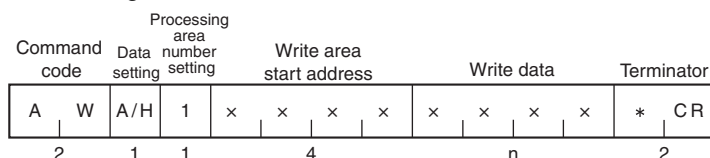

Processing Area Number: 2

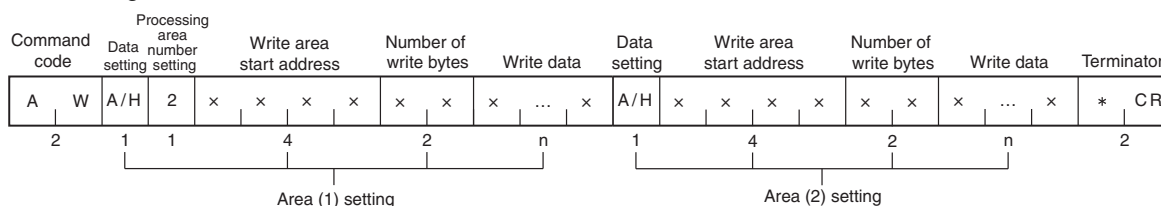

Data setting	<p>Sets the code format used to send responses for write data.</p> <p>A: ASCII H: Hexadecimal</p> <p>When multiple processing areas are used, ASCII and hexadecimal can be specified at the same time within a single command frame.</p>
Processing area number setting	<p>Specifies the processing area number.</p> <p>Setting range: 1 to 9, A (A = 10)</p>
Write area start address	<p>Specifies the start address of the area in the RF Tag to be written to in 4-digit hexadecimal.</p> <p>Setting range: 0000 to FFFF hex</p> <p>When multiple processing areas are used, specify the areas in order starting from the smallest address. The same area cannot be specified twice.</p>
Number of write bytes	<p>When multiple processing areas are used, specifies the number of bytes to be written to the RF Tag in 2-digit hexadecimal.</p> <p>The maximum number of bytes that can be written at one time is 256 bytes.</p> <ul style="list-style-type: none"> • ASCII: 256 bytes (256 characters) • Hexadecimal: 256 bytes (512 characters) <p>Setting range: 01 to FF hex</p> <p>When multiple processing areas are used, set so that the total number of bytes to be written for all areas is within 256 bytes, 6 bytes, as follows: Area (1) bytes +...+ Area (N) bytes ≤ 256 bytes</p>
Write data	<p>Indicates the data to be written to the RF Tag.</p> <p>The characters in ASCII indicate the number of write bytes and the characters in hexadecimal indicate the number of write bytes × 2</p>

Response

Command code		End code		Terminator	
A	W	0	0	*	CR
2		2		2	

End code	<p>Indicates the execution result for the command. The end code 00 indicates normal completion.</p> <p>For details on end codes, refer to <i>End code List</i>.  p.118</p>
----------	---

■ BUTTON READ (BR)

After this command is received by the Hand-held Reader/Writer, data is read from the RF Tag by pressing the activate switch. If the activate switch is pressed and the RF Tag is not in the interrogation zone, an error response (end code: 72 = RF Tag non-existent) will be returned.

Command

Processing Area Number: 1

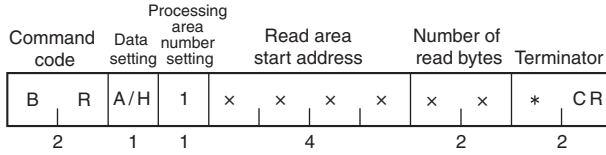

Processing Area Number: 2

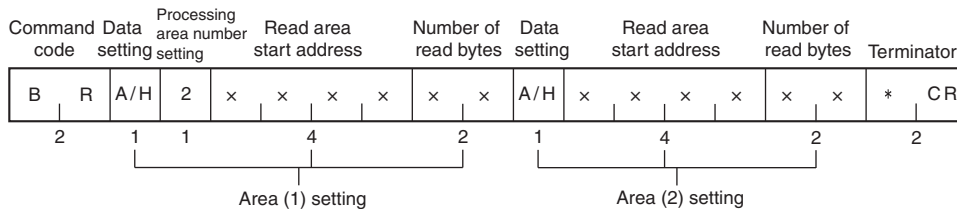

Data setting	<p>Sets the code format used to send responses for read data.</p> <p>A: ASCII H: Hexadecimal</p> <p>When multiple processing areas are used, ASCII and hexadecimal can be specified at the same time within a single command frame.</p>
Processing area number setting	<p>Specifies the processing area number.</p> <p>Setting range: 1 to 9, A (A = 10)</p>
Read area start address	<p>Specifies the start address of the area in the RF Tag to be read from in 4-digit hexadecimal.</p> <p>Setting range: 0000 to FFFF hex</p> <p>When multiple processing areas are used, specify the areas in order starting from the smallest address. The same area cannot be specified twice.</p>
Number of read bytes	<p>Specifies the number of bytes to be read from the RF Tag in 2-digit hexadecimal.</p> <p>The maximum number of bytes that can be read at one time is 256 bytes.</p> <ul style="list-style-type: none"> • ASCII: 256 bytes (256 characters) • Hexadecimal: 256 bytes (512 characters) <p>Setting range: 00 to FF hex (00 = 256 bytes)</p> <p>When multiple processing areas are used, set so that the total number of bytes to be read for all areas is within 256 bytes, as follows: Area (1) bytes +...+ Area (N) bytes ≤ 256 bytes</p>

Response

Processing Area Number: 1

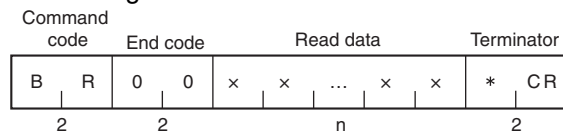

Processing Area Number: 2

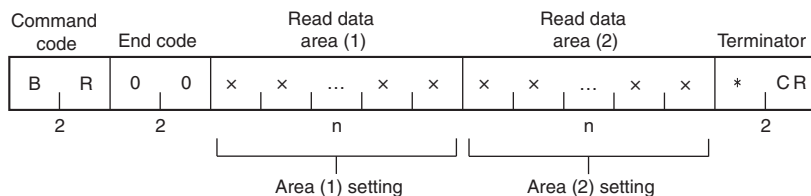

End code	<p>Indicates the execution result for the command. The end code 00 indicates normal completion.</p> <p>For details on end codes, refer to <i>End code List</i>.  p.118</p>
Read data	<p>Indicates the data read from the RF Tag. The characters in ASCII indicate the number of read bytes and the characters in hexadecimal indicate the number of read bytes x 2.</p>

■ BUTTON WRITE (BW)

After this command is received by the Hand-held Reader/Writer, data is written to the RF Tag by pressing the activate switch. If the activate switch is pressed and the RF Tag is not in the interrogation zone, an error response (end code: 72 = RF Tag non-existent) will be returned.

Command

Processing Area Number: 1

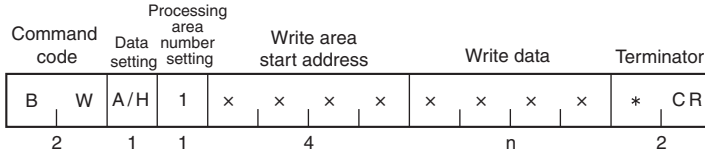

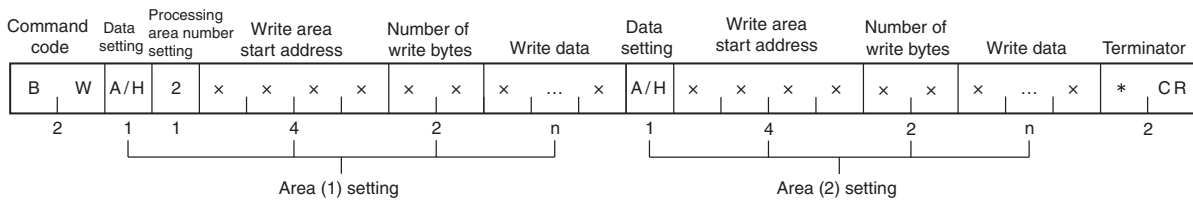

Processing Area Number: 2

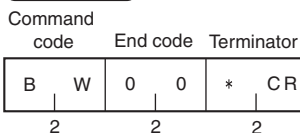

Data setting	Sets the code format used to send responses for write data. A: ASCII H: Hexadecimal When multiple processing areas are used, ASCII and hexadecimal can be specified at the same time within a single command frame.
Processing area number setting	Specifies the processing area number. Setting range: 1 to 9, A (A = 10)
Write area start address	Specifies the start address of the area in the RF Tag to be written to in 4-digit hexadecimal. Setting range: 0000 to FFFF hex When multiple processing areas are used, specify the areas in order starting from the smallest address. The same area cannot be specified twice.
Number of write bytes	When multiple processing areas are used, specifies the number of bytes to be written to the RF Tag in 2-digit hexadecimal. The maximum number of bytes that can be written at one time is 256 bytes. • ASCII: 256 bytes (256 characters) • Hexadecimal: 256 bytes (512 characters) Setting range: 01 to FF hex When multiple processing areas are used, set so that the total number of bytes to be written for all areas is within 256 bytes, as follows: Area (1) bytes +...+ Area (N) bytes ≤ 256 bytes
Write data	Indicates the data to be written to the RF Tag. The characters in ASCII indicate the number of write bytes and the characters in hexadecimal indicate the number of write bytes x 2.

Response



End code	Indicates the execution result for the command. The end code 00 indicates normal completion. For details on end codes, refer to <i>End code List</i> .  p.118
----------	---

■ BUTTON AUTO READ (UR)

After this command is received by the Hand-held Reader/Writer, data will be read from the RF Tag after the activate switch is pressed and the Hand-held Reader/Writer is close to the RF Tag. The Hand-held Reader/Writer responds when communications between the Hand-held Reader/Writer and RF Tag have ended.

Command

Processing Area Number: 1

Command code	Data setting	Processing area number setting	Read area start address	Number of read bytes	Terminator
U	R	A/H	1	x x x x	x x * CR
2	1	1	4	2	2

Processing Area Number: 2

Command code	Data setting	Processing area number setting	Read area start address	Number of read bytes	Data setting	Read area start address	Number of read bytes	Terminator
U	R	A/H	2	x x x x	A/H	x x x x	x x	* CR
2	1	1	4	2	1	4	2	2
			Area (1) setting		Area (2) setting			

Data setting	Sets the code format used to send responses for read data. A: ASCII H: Hexadecimal When multiple processing areas are used, ASCII and hexadecimal can be specified at the same time within a single command frame.
Processing area number setting	Specifies the processing area number. Setting range: 1 to 9, A (A = 10)
Read area start address	Specifies the start address of the area in the RF Tag to be read from in 4-digit hexadecimal. Setting range: 0000 to FFFF hex When multiple processing areas are used, specify the areas in order starting from the smallest address. The same area cannot be specified twice.
Number of read bytes	Specifies the number of bytes to be read from the RF Tag in 2-digit hexadecimal. The maximum number of bytes that can be read at one time is 256 bytes. • ASCII: 256 bytes (256 characters) • Hexadecimal: 256 bytes (512 characters) Setting range: 00 to FF hex (00 = 256 bytes) When multiple processing areas are used, set so that the total number of bytes to be read for all areas is within 256 bytes, as follows: Area (1) bytes +...+ Area (N) bytes ≤ 256 bytes

Response

Processing Area Number: 1

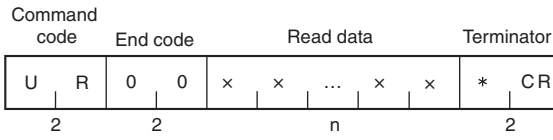

Processing Area Number: 2

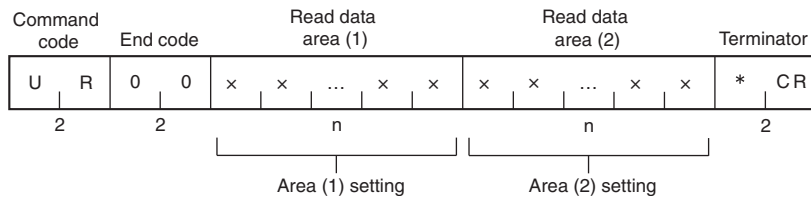

End code	Indicates the execution result for the command. The end code 00 indicates normal completion. For details on end codes, refer to <i>End code List</i> .  p.118
Read data	Indicates the data read from the RF Tag. The characters in ASCII indicate the number of read bytes and the characters in hexadecimal indicate the number of read bytes x 2.

■ BUTTON AUTO WRITE (UW)

After this command is received by the Hand-held Reader/Writer, data will be written to the RF Tag after the activate switch is pressed and the Hand-held Reader/Writer is close to the RF Tag. The Hand-held Reader/Writer responds when communications between the Hand-held Reader/Writer and RF Tag have ended.

Command

Processing Area Number: 1

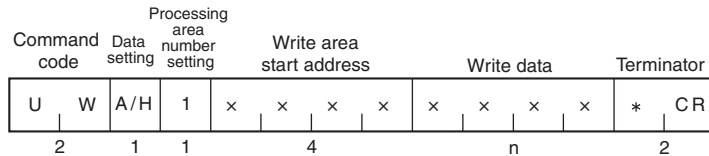

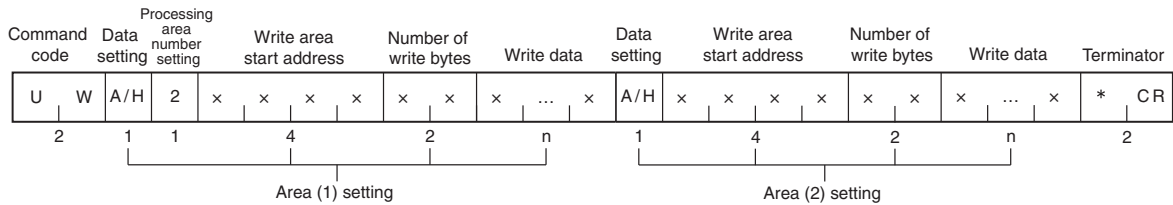

Processing Area Number: 2

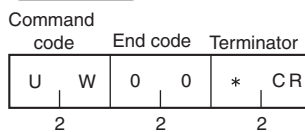

Data setting	Sets the code format used to send responses for write data. A: ASCII H: Hexadecimal When multiple processing areas are used, ASCII and hexadecimal can be specified at the same time within a single command frame.
Processing area number setting	Specifies the processing area number. Setting range: 1 to 9, A (A = 10)
Write area start address	Specifies the start address of the area in the RF Tag to be written to in 4-digit hexadecimal. Setting range: 0000 to FFFF hex When multiple processing areas are used, specify the areas in order starting from the smallest address. The same area cannot be specified twice.
Number of write bytes	When multiple processing areas are used, specifies the number of bytes to be written to the RF Tag in 2-digit hexadecimal. The maximum number of bytes that can be written at one time is 256 bytes. • ASCII: 256 bytes (256 characters) • Hexadecimal: 256 bytes (512 characters) Setting range: 01 to FF hex When multiple processing areas are used, set so that the total number of bytes to be written for all areas is within 256 bytes, as follows: Area (1) bytes +...+ Area (N) bytes ≤ 256 bytes
Write data	Indicates the data to be written to the RF Tag. The characters in ASCII indicate the number of write bytes and the characters in hexadecimal indicate the number of write bytes x 2.

Response



End code	Indicates the execution result for the command. The end code 00 indicates normal completion. For details on end codes, refer to <i>End code List</i> .  p.118
----------	---

■ Calculation Write (CW)

The RF Tag's memory data and calculation data is calculated in hexadecimal and the result is written to the RF Tag. If an overflow during addition or underflow during subtraction occurs, the data will not be written and an error response (end code: 76 = Data check error) will be returned.

Command													
Command code		Data setting	Processing area number setting	Calculation area start address				Number of calculation area bytes		Calculation data		Terminator	
C	W	A/S	1	x	x	x	x	x	x			*	CR
2		1	1	4				2		Specified number of bytes		2	

Processing specification	Specifies the calculation method. A: Add hexadecimal S: Subtract hexadecimal
Processing area number setting	Always 1.
Calculation area start address	Specifies the start address of the area to be written to in 4-digit hexadecimal. Setting range: 0000 to FFFF hex
Number of calculation area bytes	Specifies the number of bytes in the area for calculating data in 2-digit hexadecimal. Setting range: 01 to 04 hex
Calculation data	Specifies the numerical values to be calculated in hexadecimal.

Response							
Command code		End code		Calculation data		Terminator	
C	W	0	0			*	CR
2		2		Specified number of bytes		2	

End code	Indicates the execution result for the command. The end code 00 indicates normal completion. For details on end codes, refer to <i>End code List</i> .  p.118
Calculation data	Returns the calculation result data written to the RF Tag. If an overflow during addition or underflow during subtraction occurs, the end code 76 (data check error) will be returned. The data prior to the calculation will not be added to the response.

DATA FILL (FL)

Writes fill data for the specified number of bytes beginning from the start address specified in the RF Tag. The write data is specified in hexadecimal.

If there is no Tag in the interrogation zone when the Hand-held Reader/Writer receives the command from the host device, the Hand-held Reader/Writer will return an error response (end code: 72 = RF Tag non-existent).



This command can be used to write data regardless of the write protection setting. Confirm that there is no important data in the area being written before executing this command.

CHECK!

Command

Command code	Data setting	Processing area number setting	Write area start address	Number of write bytes	Specified data	Terminator
F	L	H	1	x x x x	x x	x x
2	1	1	4	2	2	2

Data setting	Always H.
Processing area number setting	Always 1.
Write area start address	Specifies the start address of the area in the RF Tag to be written to in 4-digit hexadecimal. Setting range: 0000 to FFFF hex
Number of write bytes	Specifies the data to be written to the RF Tag in 2-digit hexadecimal. Setting range: 00 hex to FF hex (00 = 256 bytes)
Specified data	Indicates the data to be written to the RF Tag in hexadecimal.

Response

Command code	End code	Terminator
F	L	0 0
2	2	2

End code	Indicates the execution result for the command. The end code 00 indicates normal completion. For details on end codes, refer to <i>End code List</i> . p.118
----------	--

Example

Writing 01 hex to the 6 bytes in memory starting from address 0030 (hex) for an RF Tag in which the data at each address is the same as the address.

(hex)	Before Writing	
002F	2	F
0030	3	0
0031	3	1
0032	3	2
0033	3	3
0034	3	4
0035	3	5
0036	3	6

Command

Command code	Data setting	Processing area number setting	Write area start address	Number of write bytes	Specified data	Terminator
F	L	H	1	0 0 3 0	0 6	0 1
2	1	1	4	2	2	2

(hex)	After Writing	
002F	2	F
0030	0	1
0031	0	1
0032	0	1
0033	0	1
0034	0	1
0035	0	1
0036	3	6

Response

Command code	End code	Terminator
F	L	0 0
2	2	2

■ AUTO DATA FILL (AF)

Writes the fill data to the specified number of bytes beginning from the start address specified in the RF Tag when the RF Tag approaches. The write data is specified in hexadecimal. A response will be returned when communications with the RF Tag have been completed.



This command can be used to write data regardless of the write protection setting. Confirm that there is no important data in the area being written before executing this command.

CHECK!

Command

Command code	Data setting	Processing area number setting	Write area start address	Number of write bytes	Specified data	Terminator
A	F	H	1	x x x x	x x	x x
2	1	1	4	2	2	2

Data setting	Always H.
Processing area number setting	Always 1.
Write area start address	Specifies the start address of the area in the RF Tag to be written to in 4-digit hexadecimal. Setting range: 0000 to FFFF hex
Number of write bytes	Specifies the data to be written to the RF Tag in 2-digit hexadecimal. Setting range: 00 to FF hex (00 = 256 bytes)
Specified data	Indicates the data to be written to the RF Tag in hexadecimal.

Response

Command code	End code	Terminator
A	F	0 0
2	2	2

End code	Indicates the execution result for the command. The end code 00 indicates normal completion. For details on end codes, refer to <i>End code List</i> . p.118
----------	--

▪ Example

Writing 01 hex to the 6 bytes in memory starting from address 0030 (hex) for an RF Tag in which the data at each address is the same as the address.

Command										
Command code	Data setting	Data number setting	Write area start address				Number of write bytes	Specified data		Terminator
A	F	H	1	0	0	3	0	0	6	0 1 * CR
2	1	1	4				2	2		2

Response				
Command code	End code		Terminator	
F	L	0	0	* CR
2	2		2	

(hex)	Before Writing	
002F	2	F
0030	3	0
0031	3	1
0032	3	2
0033	3	3
0034	3	4
0035	3	5
0036	3	6

(hex)	After Writing	
002F	2	F
0030	0	1
0031	0	1
0032	0	1
0033	0	1
0034	0	1
0035	0	1
0036	3	6

■ DATA CHECK (MDC/K)

This command writes or compares the CRC code using the specified check block unit. The CRC code is calculated from the generated polynomial expression $X^{16} + X^{12} + X^5 + 1$.

Command



Command code		Process number setting	Processing area setting	Check block start address				Number of check block bytes		Terminator	
M	D	C/K	1	x	x	x	x	x	x	*	CR
		2	1	4				2		2	

Process setting	Specifies the check process. K: Check code calculation C: Check code comparison
Processing area number setting	Always 1.
Check block start address	Specifies the start address of the check block in 4-digit hexadecimal. Setting range: 0000 to FFFD hex
Number of check block bytes	Specifies the number of bytes in the check block in 2-digit hexadecimal. Setting range: 00, 03 to FF hex (00 = 256 bytes) The number of check block bytes is the check code calculation area + 2 bytes. For details, refer to <i>Memory Check Function in RF Tag</i> .  p.125

Response

Command code		End code		Terminator	
M	D	x	x	*	CR
		2		2	

End code	Indicates the execution result for the command. The end code 00 indicates normal completion. For details on end codes, refer to <i>End code List</i> .  p.118
----------	---

 For details on the memory check, refer to *Memory Check Function in RF Tag*.
 p.125
CHECK!

OVERWRITE COUNT CONTROL (MDS)

This command is used to control the number of overwrite operations performed by EEPROM RF Tags. This command determines whether the EEPROM overwrite count has been exceeded when the specified number of overwrites is subtracted from the specified overwrite count control area data.

Command

Command code	Mode setting	Processing area number setting	Area start address	Decrement count	Terminator
M	D	S	1	x x x x	x x * CR
2		1	1	4	2 2

Mode setting	Always S.
Processing area number setting	Always 1.
Area start address	Specifies the start address of the overwrite count control area in 4-digit hexadecimal. Setting range: 0000 to FFFD hex
Decrement count	Specifies the number of refresh operations in 2-digit hexadecimal. Setting range: 00 to FF hex (00 = Performs overwrite count check only) If the decrement count is larger than the remaining number of overwrite operations, the decrement count is overwritten to 0 and a data error warning is returned in the response. For details, refer to <i>MDS Command</i> .  p.123

Response

Command code	End code	Terminator
M	D	0 0 * CR
2		2 2

End code	Indicates the execution result for the command. 00: Normal completion 76: Data error warning For details on end codes, refer to <i>End code List</i> .  p.118
----------	--



For details on controlling the overwrite count, refer to *MDS Command*.

CHECK!



p.123

■ ID CODE READ (ID)

Reads the ID code in the RF Tag.

Command

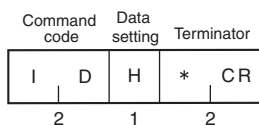

Data setting	Always H.
--------------	-----------

Response

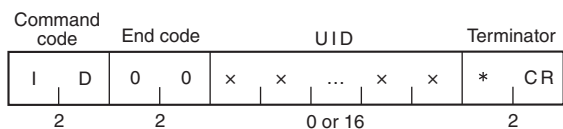

End code	Indicates the execution result for the command. The end code 00 indicates normal completion. For details on end codes, refer to <i>End code List</i> .  p.118
UID	The UID is an ID that uniquely identifies an RF Tag. (Unique Identifier) Note: An ID code will not be attached if an error occurs.



The ID READ command writes the ID code to the RF Tag's memory, and will thus be affected by the ambient temperature. Be careful when using the RF Tag in environments with high ambient temperatures.

Communications Subcommands

Communications subcommands are used together with communications commands. Communications with the RF Tag cannot be performed using only these subcommands.

■ COMMAND PROCESSING TERMINATE (AA)

Terminates the processing of the communications commands and restores the command wait status.

Command			
Command code		Terminator	
A	A	*	CR
2	2	2	2

Response					
Command code		Termination End code		Termination timing	Terminator
A	A	0	0	x	* CR
2	2	2	2	1	2

End code	Indicates the execution result for the command. 00: Normal completion 15: Command processing not executed. For details on end codes, refer to <i>End code List</i> .  p.118
Termination timing	Indicates the timing for terminating command processing. 0: Terminate before RF Tag detection. 1: Terminate during RF Tag detection.

Host Commands

■ TEST (TS)

This command returns test messages sent from the host device without changing anything.

The TEST command is used for communications tests between the host device and the Hand-held Reader/Writer.

Command

Command code		Message data					Terminator	
T	S	x	x	x	...	x	*	CR
2		n					2	

Message data	Any text string for testing communications containing 514 characters max.
--------------	---

Response

Command code		End code		Message data					Terminator	
T	S	0	0	x	x	x	...	x	*	CR
2		2		n					2	

End code	<p>Indicates the execution result for the command. 00: Normal completion</p> <p>For details on end codes, refer to <i>End code List</i>.  p.118</p>
Message data	Any text string for testing communications containing 514 characters max.

■ VERSION READ (VS)

Command

Command code Terminator

V	S	*	CR
2	2		

Response

Command code End code

Terminator

V	S	0	0	Software model	:	Software version	:	Creation date	*	CR
2	2			16	1	4	1	10		2

Software model	The software creation date. For the V680-CHUD: V680-CHUD\$000000 For the V680-CH1D: V680-CH1D\$000000 For the V680-CH1D-PSI: V680-CH1D\$000000
Software version	The software version. *.*
Software creation date	The software creation date. 20**/**/**

Controller Control Commands

These commands are used to reset the Controller or set serial communications.

■ ABORT (XZ)

This command is used to restore the Hand-held Reader/Writer to command wait status when there is no response from the Hand-held Reader/Writer due to some problem during communications with the host device or with an RF Tag.



The ABORT (XZ) command can be used only with the V680-CH1D.
Do not use it with the V680-CHUD.

CHECK!

Command

Command code		Terminator	
X	Z	*	CR
2		2	

Response

None

■ COMMUNICATIONS CONDITIONS SETTING (TR)

This command is used to set serial communications parameters. The Hand-held Reader/Writer must be restarted to make the changes take effect.



The COMMUNICATIONS CONDITIONS SETTING (TR) command can be used only with the V680-CH1D.
Do not use it with the V680-CHUD.

CHECK!

Command

Command Baud Data Parity Stop
code rate length bits Terminator

T	R	x	x	x	x	*	CR
2	1	1	1	1	1	2	

Baud rate	Sets the baud rate. 0: 9,600 bps 1: 2,400 bps 2: 4,800 bps 3: 19,200 bps 4: 38,400 bps Default setting: 9,600 bps
Data length	Sets the data length. 0: 7 bits 1: 8 bits Default setting: 7 bits
Parity	Sets the parity. 0: Even parity 1: Odd parity 2: No parity Default setting: Even parity
Stop bits	Sets the number of stop bits. 0: 2 bits 1: 1 bit Default setting: 2 bits

Response

Command End code Terminator
code

T	R	0	0	*	CR
2	2	2	2	2	

End code	Indicates the execution result for the command. 00: Normal completion For details on end codes, refer to <i>End code List</i> . p.118
----------	--

■ BASIC FUNCTIONS SETTING (FN)

This command is used to set the Auto Commands OFF function. The Hand-held Reader/Writer must be restarted to make the changes take effect.



A memory error will occur if the power supply is interrupted while parameters are being changed.

CHECK!

Command

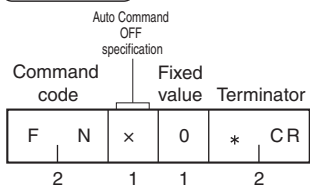

Auto Command OFF specifications	Designates whether the Auto Command OFF function is used. 0: Auto Command OFF used. 1: Auto Command OFF not used. Default setting: Auto Command OFF used.
Fixed value	Always 0.

Response

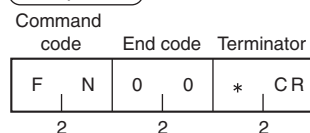

End code	Indicates the execution result for the command. 00: Normal completion For details on end codes, refer to <i>End code List</i> . p.118
----------	--

■ SET INFORMATION READ (UL)

This command is used to read the settings of the Hand-held Reader/Writer.



Only the Auto Command OFF function is supported by the V680-CHUD.

The settings made with the COMMUNICATIONS CONDITIONS SETTING (TR) command are not valid for the V600-CHUD.

CHECK!



A memory error will occur if the power supply is interrupted while parameters are being changed.

CHECK!

Command

Command code		Terminator	
U	L	*	CR
2		2	

Response

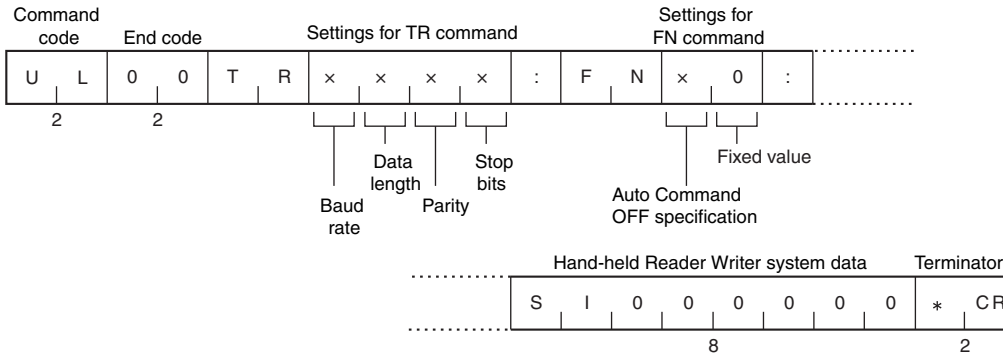

End code	Indicates the execution result for the command. 00: Normal completion For details on end codes, refer to <i>End code List</i> . p.118	
Settings for TR command	Baud rate	0: 9,600 bps 1: 2,400 bps 2: 4,800 bps 3: 19,200 bps 4: 38,400 bps
	Data length	0: 7 bits 1: 8 bits
	Parity	0: Even parity 1: Odd parity 2: No parity
	Stop bits	0: 2 bits 1: 1 bit
Settings for FN command	Auto Command OFF Specification	0: Auto Command OFF used. 1: Auto Command OFF not used.
	Fixed value	Always 0.
System data	SI000000	

PARAMETER SET (SP)

The PARAMETER SET command is used to set conditions for communicating with RF Tags. The various parameters are set in the Hand-held Reader/Writer.



The Hand-held Reader/Writer does not need to be reset when internal settings are changed. The new settings are effective immediately.

CHECK!



A memory error will occur if the power supply is interrupted while parameters are being changed.

CHECK!

Command

Command code		Process code		Parameter data (for changed parameters only)				Terminator	
S	P	x	x	x	x	x	x	*	CR
2		2		0 to 4				2	

Process code (Upper digit)	Specifies the process to perform for the parameter. 0: Change the internal setting. 1: Read internal setting. 9: Return internal setting to default value.	
Process code (Lower digit)	Specifies the parameter. 1: Inter-character monitoring time 2: Response delay time 4: Auto command cancel time H: Write protection setting J: Protocol switch L: Tag memory setting (See note 1.)	
Parameter data (for changed parameters only)	Data No. (See note 2.)	Settable values
	1	Specify 4 decimal digits. 0000 to 9999 (ms) 0000: No monitoring, Default value: 0100 (ms)
	2	Specify 2 decimal digits. 00 to 99 (ms) 00: No delay, Default value: 20 (ms)
	4	Specify 2 decimal digits. 01 to 99 (s) Default value: 60 (s)
	H	00: Write protection OFF 01: Write protection ON (default value)
	J	00: V600 protocol (default value) 01: V680 protocol
	L	0: Standard Mode (default value) 1: CA1D Mode

Note 1.: Parameter data L is enabled only with version 1.1 or newer.

Note 2.: The data number of the parameter data is the number specified for the lower digit of the process code.

The settable values for the data number are the same as for the parameter specified by the lower digit of the process code.

Response

Command code		End code		Parameter data				Terminator	
S	P	0	0	x	x	x	x	*	CR
2		2		0 to 4				2	

End code	Indicates the execution result for the command. 00: Normal completion For details on end codes, refer to <i>End code List</i> . p.118
Parameter data	Attached only when parameter data is being obtained.

Other Commands

■ UNDEFINED COMMAND RESPONSE (IC)

This command is returned as the response when the Hand-held Reader/Writer cannot read the command header.

Response		
Command code	End code	Terminator
I C	x x	* CR
2	2	2

■ Error Response

If an error occurs during communications with the host device, or the RF Tag, error notification is provided in the end code.

Response		
Command code	End code	Terminator
x x	x x	* CR
2	2	2

End code List

End codes are indicated in 2-digit hexadecimal.

Status	End code	Meaning
Normal	00	Normal completion
Host communications error	10 *1	Vertical parity error
	11 *1	Framing error
	12 *1	Overrun error
	14	Format error
	15	Execution status error
	18	Frame length error
Lower communications error	70	RF Tag communications error
	71	Mismatch error
	72	RF Tag non-existent error
	76	Data error
	7A	Address error
	7C	Antenna error
	7D	Write protection error
Memory error	93	Internal memory error

*1) Vertical parity errors, framing errors, and overrun errors do not occur for the V680-CHUD.



For details on each error, refer to *Error Tables*.

CHECK!



p.128

Section 4 Functions

☒ Hand-held Reader/Writer Functions	120
Multiple Area Control	120
Auto Command OFF Function	120
☒ Write Protection Function	121
☒ RF Tag Service Life Detection	123
☒ Memory Check Function in RF Tag	125
☒ RF Tag Memory Error Correction	126

Hand-held Reader/Writer Functions

Multiple Area Control

The Hand-held Reader/Writer can read and write across several non-consecutive RF Tag memory areas (10 areas max.) at one time. To use this feature, the number of control areas is specified using the NUMBER OF CONTROL AREAS command. ASCII and hexadecimal can be used simultaneously for the one command control, but reading and writing cannot be performed simultaneously.

Example: Data in the Following 3 Areas are Read

- Area (1): Address 0010 (hex)
 Number of bytes 05 bytes
 Code setting ASCII
- Area (2): Address 0030 (hex)
 Number of bytes 02 bytes
 Code setting Hexadecimal
- Area (3): Address 0035 (hex)
 Number of bytes 03 bytes
 Code setting Hexadecimal

		(hex)		
Area (1)	0010	4	F	"O"
	0011	4	D	"M"
	0012	5	2	"R"
	0013	4	F	"O"
	0014	4	E	"N"
Area (2)	0030	1	2	
	0031	3	4	
Area (3)	0035	3	1	
	0036	3	2	
	0037	3	3	

Command R D A 3 0 0 1 0 0 5 H 0 0 3 0 0 2 H 0 0 3 5 0 3 * CR
 Response R D 0 0 O M R O N 1 2 3 4 3 1 3 2 3 3 * CR
 └─ Area (1) ─┘ └─ Area (2) ─┘ └─ Area (3) ─┘

 Refer to *Command and Response Formats* for more details on ASCII and hexadecimal.

 CHECK!  p.63

 Multiple area control can be used only for V600 commands and cannot be used with the V680.

 CHECK!

Auto Command OFF Function

If communications with the RF Tag do not begin within one minute (see note) after an auto command or button auto command is sent from the host device to the Hand-held Reader/Writer after entering the RF Tag wait status, the Auto Command OFF function automatically aborts the auto command and returns an "RF Tag non-existent" error (error code 72) to the host device. When the Auto Command OFF function is not used, the auto command will not be aborted even if one minute passes after entering the RF Tag wait status.

This function is set using the BASIC FUNCTIONS SETTING (FN) command.

Note: The one-minute detection time limit before the timeout will occur can be changed by using the PARAMETER SET command (SP).

 Refer to the section on the *BASIC FUNCTIONS SETTING (FN)* for details on the setting method.

 CHECK!  p.76

Write Protection Function

The write protection function prevents important data stored in the RF Tag, such as the product type and model, from being overwritten by other data and lost. Use the following method to set write protection after writing important data.



The write protection function can be enabled or disabled with the PARAMETER SET command (SP).

CHECK! p.116

Setting Write Protection

The write protection function is set in the four bytes of addresses 0000 through 0003 (hex) of the RF Tag's memory. The status of the most significant bit of address 0000 (hex) determines whether or not the write protection function is enabled for individual RF Tags.

Address (hex) \ Bit	7	6	5	4	3	2	1	0
0000	Yes/No		Upper two digits of start address					
0001	Lower two digits of start address							
0002	Upper two digits of end address							
0003	Lower two digits of end address							

- Write-protection Bit (most significant bit of address 0000 (hex))
 - 1: Data is write-protected
 - 0: Data is not write-protected
- Write Protection Setting Area
 - Start address: 0000 to 7FFF(hex)
 - End address: 0000 to FFFF(hex)

Settings to Write-protect Addresses 0006 through 07FF (hex)

Address (hex) \ Bit	Upper digit				Lower digit			
0000	1	0	0	0	0	0	0	0
	8				0			
0001	0	0	0	0	0	1	1	0
	0				6			
0002	0	0	0	0	0	1	1	1
	0				7			
0003	1	1	1	1	1	1	1	1
	F				F			

Settings to Not Write-protect Addresses

Address (hex) \ Bit	Upper digit				Lower digit			
0000H	0	0	0	0	0	0	0	0
	0				0			
0001H	0	0	0	0	0	1	1	0
	0				6			
0002H	0	0	0	0	0	1	1	1
	0				7			
0003H	1	1	1	1	1	1	1	1
	F				F			



The DATA FILL command will write data even to areas of the Tag for which write protection has been set. Confirm that there is no important data in the area being written before executing this command.

CHECK!

Write Protection Setting Examples

(1) Settings to Write-protect Addresses 0015 to 0120 (hex)
(Start address < End address)

Address (hex)	Bit							
	7	6	5	4	3	2	1	0
0000	1	0	0	0	0	0	0	0
	8				0			
0001	0	0	0	1	0	1	0	1
	1				5			
0002	0	0	0	0	0	0	0	1
	0				1			
0003	0	0	1	0	0	0	0	0
	2				0			

(Hexadecimal)

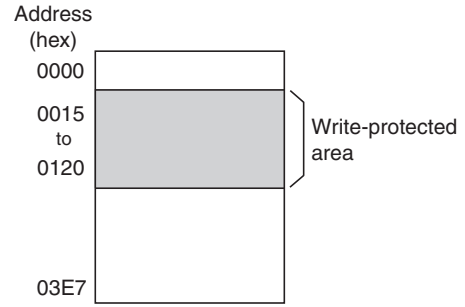

(2) Settings to Write-protect 1 Byte
(Start address = End address)

Specify the same address for the start and end addresses.

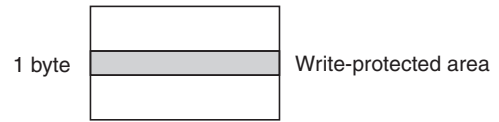

(3) Settings when the End Address Is Greater Than the Final Address in the RF Tag
(End address > Last address in RF Tag)

The RF Tag memory area is allocated from address 0000 to 03E7 (hex) when using the V680-D1KP@@. Therefore, the addresses up to 03E7 (hex) will be write-protected.

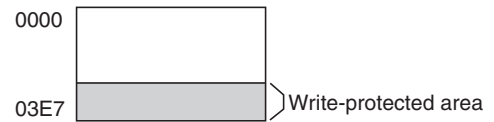

(4) Settings when the Start Address Is Greater Than the End Address
(Start address > End address)

The area between 0004 (hex) and the end address and the area between the start address and 03E7 (hex) are write-protected when using the V680-D1KP@@.

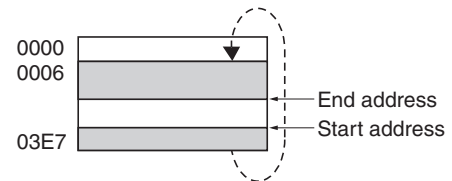

Canceling Write Protection

Canceling Write Protection for an RF Tag

To cancel write protection, turn OFF the most significant bit of address 0000 (hex). The write protection will be cancelled and the start and end addresses that are set for 0000 to 0003 (hex) will be ignored.

Canceling Write Protection for the Hand-held Reader/Writer

Use the PARAMETER SET command (SP) to disable the write protection function.

If write protection is disabled for the Hand-held Reader/Writer, even turning ON the most significant bit of address 0000 (hex) in the RF Tag will not enable write protection.

RF Tag Service Life Detection

The OVERWRITE COUNT CONTROL command (MDS/MDL) can be used to determine whether the Tag overwrite limit has been exceeded. With the MDS command, the overwrite count is subtracted from the data in the user-specified overwrite count control area to determine whether the number of overwrites has been exceeded. The MDL command can also be used to determine whether the overwrite count (100,000 times) has been exceeded. The MDL command for RF Tags with a maximum number of 100,000 overwrites.

MDS Command

The overwrite count control area consists of 3 bytes from the start address. The decrement value from the overwrite count is written in this area, and if this value is 0 (00 hex) an end code 76 will be given as a warning.

Therefore, to enable control of the number of overwrites, the maximum number of overwrites must be written to the overwrite count control area beforehand.

The user-specified number of overwrites can be set to up to 16,700,000. The number of overwrites in the specifications for EEPROM RF Tags, however, is 100,000 overwrites (0186A0 hex) at 25°C max., so be sure to set the number of overwrites to 100,000 or lower.

The number of overwrites is controlled using hexadecimal values, and can be read using the READ command.

If the control area data is already 0, the control area value will not be refreshed, and only a warning will be returned as a response. When the refresh count is set as 00 hex, the count will not be updated, and only an overwrite count check will be performed.

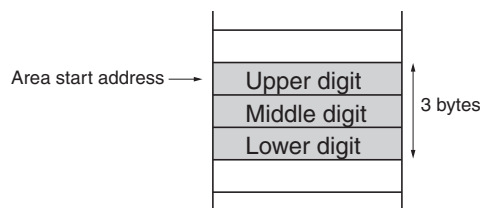

For details on the command format, refer to *OVERWRITE COUNT CONTROL (MD S/L)*.



Example Using the OVERWRITE COUNT (MDS) Command

Example: When the three bytes from address 0010 (hex) are used as the overwrite count area.

1. The overwrite count initial value of 100,000 times is written in the control area.
"WTSTH100100186A0"
2. Enter the overwrite count of 5.
"MDSTS1001005"
A total of 5 times will be decremented from 100,000.

0010	01 hex
0011	86 hex
0012	A0 hex

0010	01 hex
0011	86 hex
0012	9B hex

3. The accumulated count is 100,000 times.
When "MDSTS1001000" is executed, it will be "MD7610" (overwrite count exceeded.)

0010	00 hex
0011	00 hex
0012	00 hex



MDL Command

The overwrite count control area consists of 3 bytes from the start address. The decrement value from the overwrite count is written in this area, and if this value is 100,000 (0186A0 hex) or higher, an end code 76 will be given as a warning.

The number of overwrites is controlled using hexadecimal values, and can be read using the READ command.

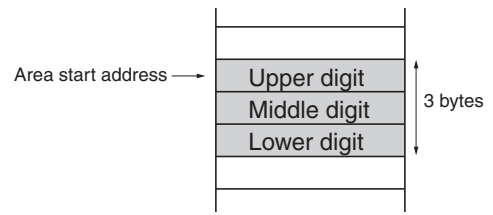
If the control area data is already 100,000, the control area value will not be refreshed, and only a warning will be returned as a response. When the refresh count is set as 00 hex, the count will not be updated, and only an overwrite count check will be performed.



 For details on the command format, refer to *OVERWRITE COUNT CONTROL (MD S/L)*.
 p.69
CHECK!

Example Using Overwrite Count Control Command (MDL)

In the following example, the three bytes starting from address 0010 (hex) is the overwrite count control area.

1. The control area is cleared.
"WTSTH10010000000"
2. The overwrite count of 4 is entered.
"MDSTL1001004"

0010	00 hex
0011	00 hex
0012	00 hex

0010	00 hex
0011	00 hex
0012	04 hex

3. Enter the overwrite count of 5.
"MDSTL1001005"
The total overwrite count becomes 9 times.
4. The accumulated count is 100,000 times.
When "MDSTL1001000" is executed, it will be "MD7610" (overwrite count exceeded.)

0010	00 hex
0011	00 hex
0012	09 hex



0010	01 hex
0011	86 hex
0012	A0 hex

Memory Check Function in RF Tag

A memory check can be made using the DATA CHECK command (MD C/K). A CRC (Cyclic Redundancy Check) code calculation, overwrite, and comparison are made, using the check block units specified by the user. The CRC code is calculated from the generated polynomial expression $x^{16} + x^{12} + x^5 + 1$.

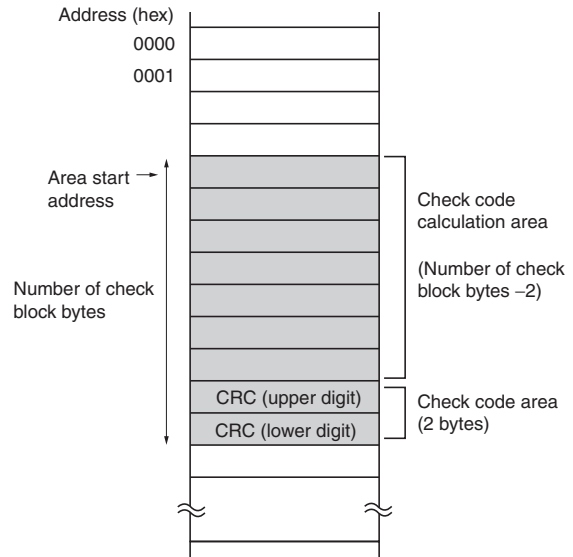
The calculation area is the portion of the check block specified by the start address and the number of bytes excluding the last two bytes. The last two bytes are the check code area. When check code write is specified (transaction code: K), the CRC of the calculation area data is calculated and written to the check code area. When data comparison is specified (transaction code: C), the CRC of the calculation area data is calculated and a comparison made with the check code area data. If they coincide, end code 00 is returned, indicating normal transmission, and if they do not coincide, end code 76 is returned as a warning.



 For details on the command format, refer to *DATA CHECK (MD C/K)*.
CHECK!  p.70

■ Example Using the RF Tag's DATA CHECK Command

In the following example, the data in address 0010 to 0012 (hex) is checked

1. In this example, the following data already exists in the memory.
2. Execute MDSTK1001005 (calculation transaction).

The CRC code 5CD6 calculated from the data 123456 is written to addresses 0013H and 0014H.

0010	12 hex
0011	34 hex
0012	56 hex
0013	
0014	

0010	12 hex
0011	34 hex
0012	56 hex
0013	5C hex
0014	D6 hex

3. Execute MDSTC1001005 (comparison transaction).

The normal response MD0010 will be returned if the data coincides.

If the data error occurs, MD7610 (a data error warning) will be returned.

0010	12 hex
0011	34 hex
0012	56 hex
0013	5C hex
0014	D6 hex

0010	00 hex	← Data error
0011	34 hex	
0012	56 hex	
0013	5C hex	
0014	D6 hex	

RF Tag Memory Error Correction

The WRITE WITH ERROR CORRECTION command (QW) can be used to write an RF Tag memory check code and error correction code to the five bytes of memory after the write data. The READ WITH ERROR CORRECTION command (QR) performs a tag memory check and makes 1-bit memory error corrections.

When a 1-bit memory error is corrected, a warning that a 1-bit memory error occurred is given by returning an end code of 77, and the normal data with the error corrected will be returned. When a 2-bit or larger memory error is detected, a memory error (end code 76) saying that error correction was not possible is given and the read data will not be returned.

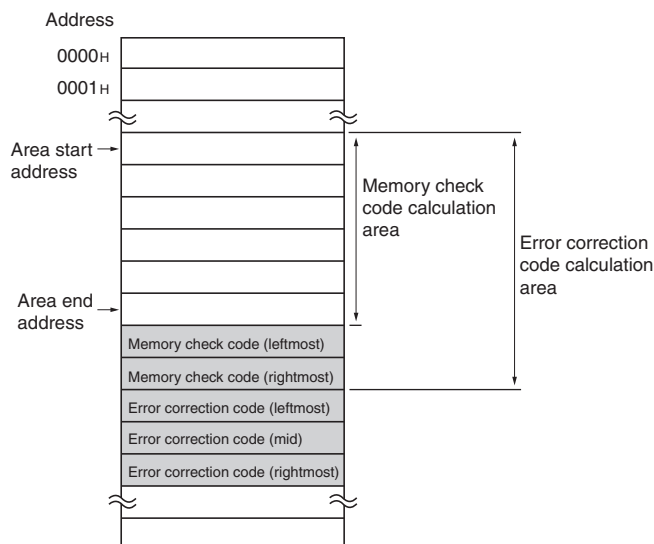

For details on the command format, refer to *READ WITH ERROR CORRECTION (QR)* and *WRITE WITH ERROR CORRECTION (QW)*.

CHECK!

p.72, p.73

Example of Using the Memory Error Correction Function

The following example shows how to perform a data check for addresses 0010 to 0015 (hex).

1. Send the WRITE WITH ERROR CORRECTION (QR) command.
Command: QWSTH10010313233343536*[CR]
2. Write data is written to addresses 0010 to 0015 (hex). The RF Tag memory check code and a 5-byte error correction code are written to addresses 0016 to 001A (hex).

Address (hex)		
0010	31	Write data (Memory check code Calculation area)
0011	32	
0012	33	
0013	34	
0014	35	
0015	36	
0016	FD	— Memory check code (leftmost)
0017	11	— Memory check code (rightmost)
0018	00	— Memory check code (leftmost)
0019	0C	— Memory check code (mid)
001A	3C	— Memory check code (rightmost)

3. Send the READ WITH ERROR CORRECTION (QW) command.
Command: QRSTH100100006*[CR]
 - Response When Read Data Is Correct:
QR0010313233343536*[CR]
 - Response When a 2-bit or Longer Memory Error Is Detected:
QR76*[CR]

- Response When a 1-bit Memory Error Is Corrected:
QR7710313233343536*[CR]

Section 5

Troubleshooting

❏ Error Tables	128
Fatal Errors (Operation Stops)	128
Non-fatal Errors (Operation Continues)	128
❏ Troubleshooting Flowchart	129

Error Tables

If an error occurs in the Hand-held Reader/Writer, the operation indicator will light or flash red to indicate the type of error.

Fatal Errors (Operation Stops)

If a fatal error occurs, the operation indicator will be lit red and all operations of the Hand-held Reader/Writer will stop until the power is turned OFF and then ON again.

Communications with the host will still be possible even if a memory error occurs.

Name	Operation indicator	Description
Hardware error	Lit red	Hand-held Reader/Writer cannot be operated normally.
Memory error	Lit red	The contents of the backup memory in the Hand-held Reader/Writer is corrupted.

Non-fatal Errors (Operation Continues)

If a non-fatal error occurs, the operation indicator will light or flash red (or flashing red) and an error code will be returned to the host device.

Name	Operation indicator	Description
Parity error	Flashing red	A parity error has occurred in communications with the host device.
Framing error	Flashing red	A framing error has occurred in communications with the host device.
Overrun error	Flashing red	An overrun error has occurred in communications with the host device.
Format error	Flashing red	The command from the host device was incorrectly formatted.
Frame length error	Flashing red	Command exceeding the maximum frame length was received.
RF Tag communications error	Lit red	Communications with the RF Tag could not be performed correctly.
Mismatch error	Lit red	Write control was not performed correctly.
RF Tag non-existent error	Flashing red	A command that was not an auto command was sent when the RF Tag was not in the interrogation zone. A command OFF occurred with the auto command.
Address error	Lit red	An address that exceeded the RF Tag memory area was designated.
Write protection error	Lit red	A write protection area was designated with a WRITE command.

Troubleshooting Flowchart

If an error occurs, be sure to understand the conditions thoroughly, then accurately determine the likelihood of the error re-occurring, whether the problem is related to another device, and other factors causing the error, and refer to the following flowcharts for troubleshooting.

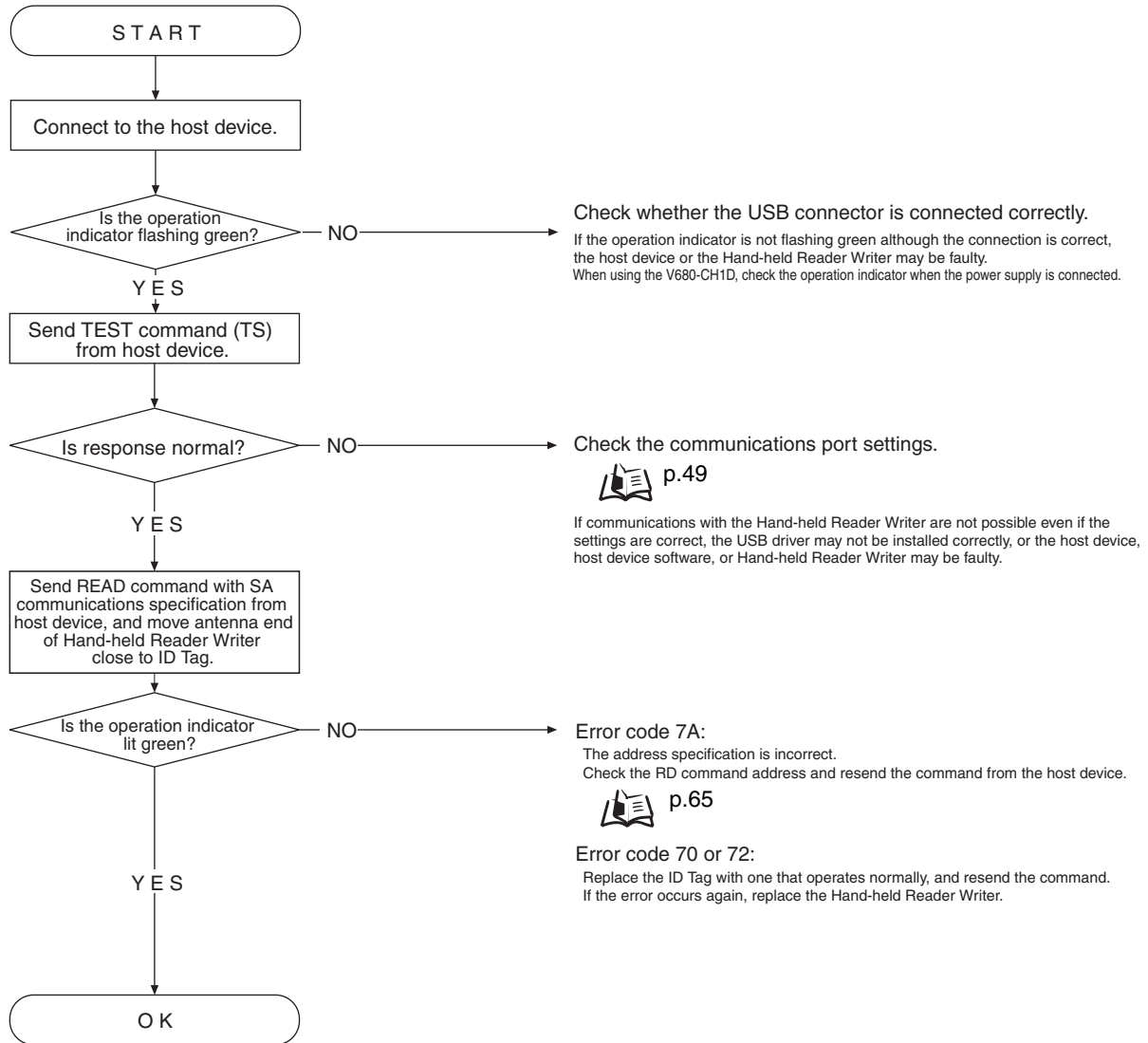

MEMO

Section 6

Appendices

☒ Specifications and Dimensions	132
☒ RF Tag Memory Map	149
☒ RF Tag Memory Capacities and Memory Types (V680 Series)	150
☒ List of ASCII Characters	151
☒ Degree of Protection	152

Specifications and Dimensions

General Specifications

Item	Specification			
	V680-CHUD		V680-CH1D	V680-CH1D-PSI
	0.8 m	1.9 m		
Supply voltage	5.0 VDC \pm 5% (at Reader/Writer connector)			
Ambient operating temperature	0 to 40°C			
Ambient operating humidity	35% to 85% (with no condensation)			
Ambient storage temperature	-25 to 65°C			
Ambient storage humidity	35% to 85% (with no condensation)			
Degree of protection	IEC60529, IP63 (See note.)			
Weight	Approx. 110 g (with cables and connectors)	Approx. 140 g (with cables and connectors)	Approx. 170 g (with cables and connectors)	Approx. 120 g (with cables and connectors)
Current consumption	500 mA max. (supply voltage: 5.0 V)			
Material	Case: ABS resin; Nameplate: PET resin			
Vibration resistance	10 to 150 Hz, 0.2-mm double amplitude at 15 m/s ² acceleration in 6 directions 10 times for 8 minutes each			
Shock resistance	150 m/s ² (approx. 15G), 3 times each in 6 directions (up, down, right, left, forward, reverse)			
Insulation resistance	50 M Ω min. (at 500 VDC) between connector terminals and case			
Dielectric strength	1,000 VAC, 50/60 Hz for 1 min between connector terminals and case (leakage current: 1 mA max.)			
Cable length	0.8 m	1.9 m	2.5 m	0.8 m

Note: This does not include the connector section. The main unit is not resistant to chemicals or oils.

Performance Specifications

Item	Specification
Diagnostic function	Checks for CPU errors, memory errors, and communications errors

V600-A22 Specifications

Item	Specification
Input voltage	100 to 120 VAC at 50/60 Hz
Input current	300 mA AC (load current: 2.0 A)
Output voltage	5 VDC \pm 0.25 V
Ambient operating temperature	0 to 40°C
Ambient storage temperature	-20 to 85°C (with no icing)
Ambient storage humidity	5% to 95% (with no condensation)
Insulation resistance	100 M Ω min. (at 500 VDC) between input terminals and output terminals
Dielectric strength	2,000 VAC for 1 min between input terminals and output terminals (leakage current: 10 mA max.)
Weight	Approx. 70 g
Applicable standards	UL

Communications Specifications

Host Communications Interface Specifications

V680-CHUD

Item	Specification
Connectors (connector connection status)	Series A plug
USB specifications	Ver 1.1
Baud rate	Full speed (12 Mbps)
Device class	COM class
Vendor ID	Hexadecimal format [0590]
Product ID	Hexadecimal format [0048]



Use the host communications interface as the COM port for the host device.

CHECK!

V680-CH1D, V680-CH1D-PSI

Item	V680-CH1D	V680-CH1D-PSI
Connector	D-Sub 9-pin (applicable to IBM PC/AT or compatible) (See note 1.)	D-Sub 9-pin
Standard compliance	RS-232C	
Transmission line connection	1:1	
Communications method	Two-wire, half duplex	
Synchronization method	Asynchronous (stop bit: 1 or 2) (See note 2.)	
Baud rate	2,400, 4,800, 9,600, 19,200, 38,400 bps (See note 2.)	
Transmission code	7-unit ASCII or 8-unit JIS (See note 2.)	
Communications control	1:1	
Error detection	Vertical parity (even/odd/none) (See note 2.)	

Note 1: For conversion to a 25-pin connector, use the SGC-X9P/25P-2 manufactured by Sunhayato, or an equivalent.

2: Set by a settings command.

Dimensions

V680-CHUD

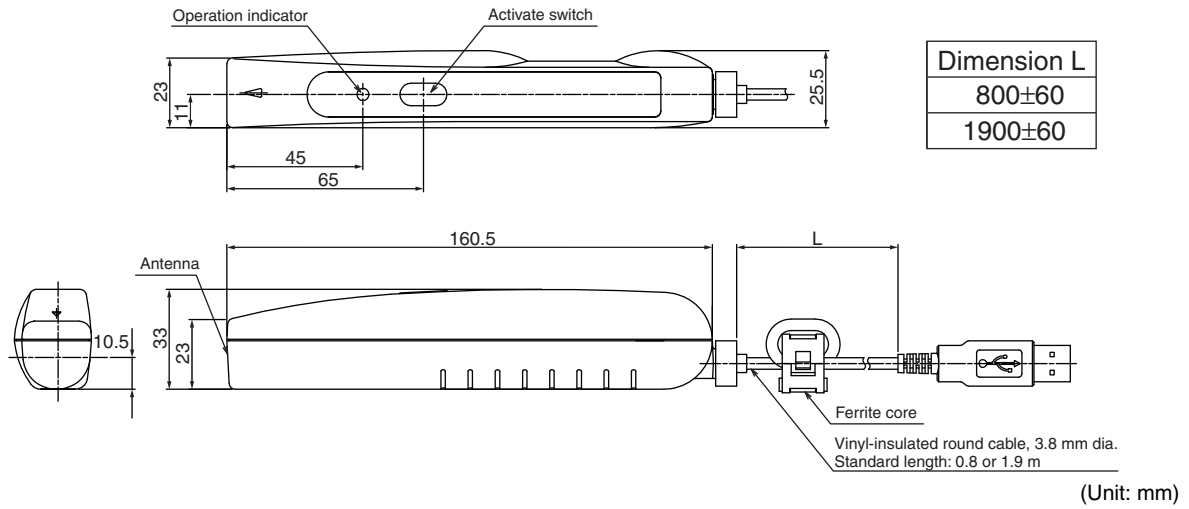

V680-CH1D

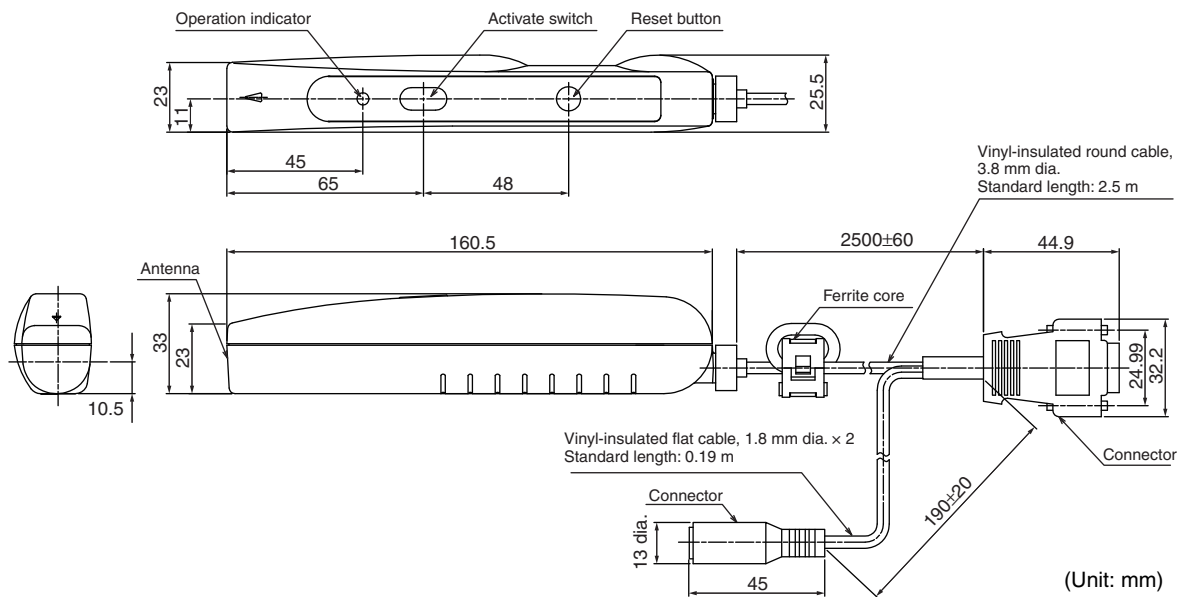

V680-CH1D-PSI

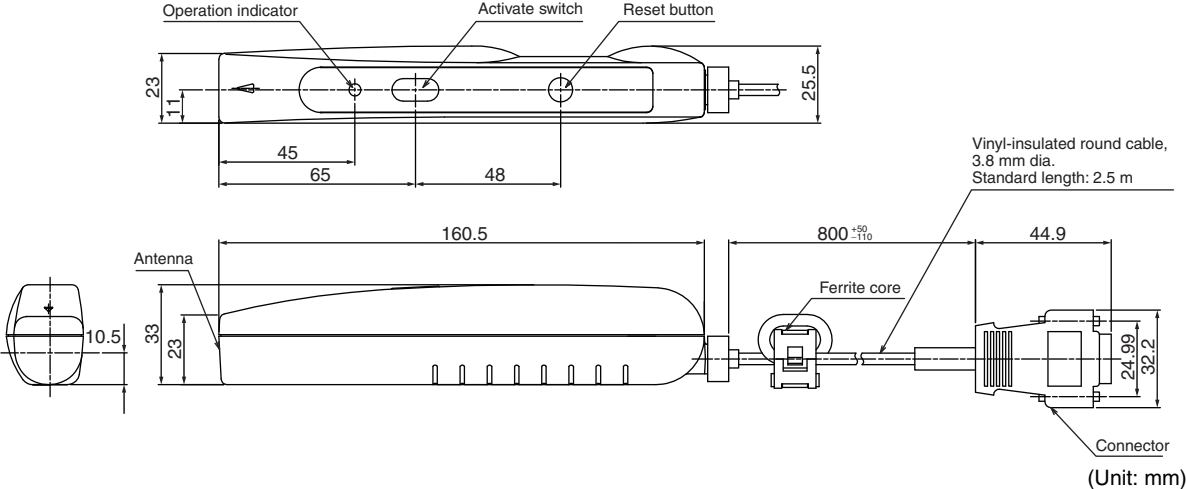

V600-A22

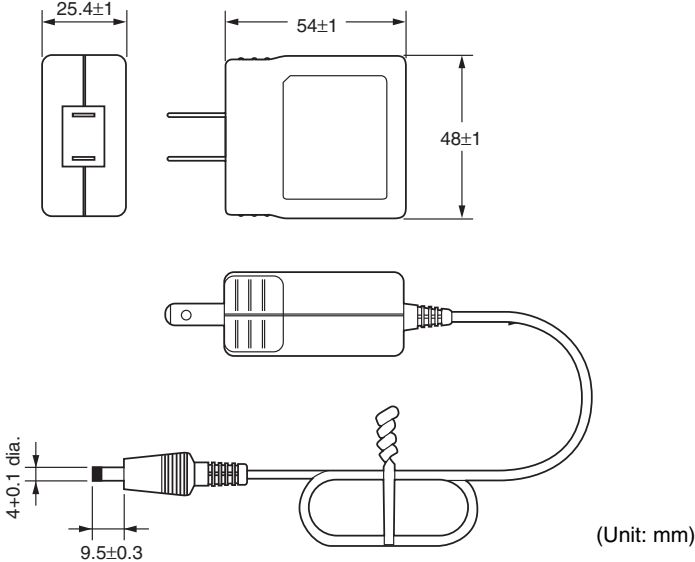

Communication Specifications

Communication with the currently available V680/V680S-series RF Tags is possible.

Communications Ranges

RF Tag	Communications range
V680-D1KP52MT	Read 0 to 9.0 mm
	Write 0 to 7.5 mm
V680-D1KP52MT Embedded in metal (iron)	Read 0 to 3.0 mm
	Write 0 to 2.5 mm
V680-D1KP53M	Read 0 to 9.0 mm
	Write 0 to 7.5 mm
V680-D1KP53M Embedded in metal (iron)	Read 0 to 3.0 mm
	Write 0 to 2.5 mm
V680-D1KP66MT	Read 0 to 21.0 mm
	Write 0 to 18.0mm
V680-D1KP66T	Read 0 to 27.0 mm
	Write 0 to 25.0 mm
V680-D1KP66T-SP	Read 0 to 25.0 mm
	Write 0 to 23.0 mm
V680-D1KP58HT	Read 0 to 19.0 mm
	Write 0 to 17.0 mm
V680-D1KP58HTN	Read 0 to 19.0 mm
	Write 0 to 17.0 mm

RF Tag	Communications range
V680-D2KF52M	Read 0 to 7.0 mm
	Write 0 to 7.0 mm
V680-D2KF52M Embedded in metal (iron)	Read 0 to 2.0 mm
	Write 0 to 2.0 mm
V680-D8KF67M	Read 0 to 22.0 mm
	Write 0 to 22.0 mm
V680-D8KF67	Read 0 to 28.0 mm
	Write 0 to 28.0 mm
V680-D8KF68	Read 0 to 32 mm
	Write 0 to 32 mm
V680-D32KF68	Read 0 to 32 mm
	Write 0 to 32 mm
V680S-D2KF67	Read 0 to 22.0 mm
	Write 0 to 22.0 mm
V680S-D2KF67M	Read 0 to 22.0 mm
	Write 0 to 22.0 mm
V680S-D2KF68	Read 0 to 22.0 mm
	Write 0 to 22.0 mm
V680S-D2KF68M	Read 0 to 22.0 mm
	Write 0 to 22.0 mm
V680S-D8KF67	Read 0 to 22.0 mm
	Write 0 to 22.0 mm
V680S-D8KF67M	Read 0 to 22.0 mm
	Write 0 to 22.0 mm
V680S-D8KF68	Read 0 to 22.0 mm
	Write 0 to 22.0 mm
V680S-D8KF68M	Read 0 to 22.0 mm
	Write 0 to 22.0 mm

The above communications ranges given here are for reference only. The communications ranges are from tests conducted a room temperature(23 °C).

Note 1: RF Tag Installation Conditions

- V680-D1KP52MT Embedded in resin/Embedded in metal (iron)
- V680-D1KP53M Embedded in resin/Embedded in metal (iron)
- V680-D1KP66MT Metal (iron) on the back surface of the RF Tag.
- V680-D1KP66T Resin on the back surface of the RF Tag.
RF Tag (no metal on back surface)
- V680-D1KP66T-SP Resin on the back surface of the RF Tag.
RF Tag (no metal on back surface)
- V680-D1KP58HT Resin on the back surface of the RF Tag.
RF Tag (no metal on back surface)
- V680-D1KP58HTN Resin on the back surface of the RF Tag.
RF Tag (no metal on back surface)
- V680-D2KF52M Embedded in resin/Embedded in metal (iron)
- V680-D8KF67M Metal (iron) on the back surface of the RF Tag.
- V680-D8KF67 Resin on the back surface of the RF Tag.
RF Tag (no metal on back surface)
- V680-D8KF68 Resin on the back surface of the RF Tag.
RF Tag (no metal on back surface)
- V680-D32KF68 Resin on the back surface of the RF Tag.
RF Tag (no metal on back surface)
- V680S-D2KF67 Resin on the back surface of the RF Tag.
RF Tag (no metal on back surface)
- V680S-D2KF67M Metal (iron) on the back surface of the RF Tag.
- V680S-D2KF68 Resin on the back surface of the RF Tag.
RF Tag (no metal on back surface)
- V680S-D2KF68M Metal (iron) on the back surface of the RF Tag.
- V680S-D8KF67 Resin on the back surface of the RF Tag.
RF Tag (no metal on back surface)
- V680S-D8KF67M Metal (iron) on the back surface of the RF Tag.
- V680S-D8KF68 Resin on the back surface of the RF Tag.
RF Tag (no metal on back surface)
- V680S-D8KF68M Metal (iron) on the back surface of the RF Tag.

■ Interrogation Zone (Reference)

● V680-D1KP52MT

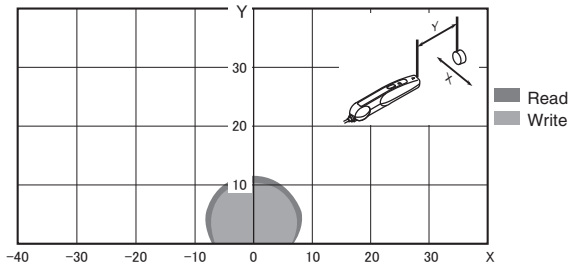

● V680-D1KP52MT

Embedded in metal (iron)

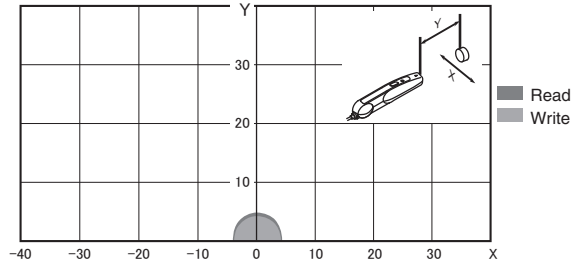

● V680-D1KP53M

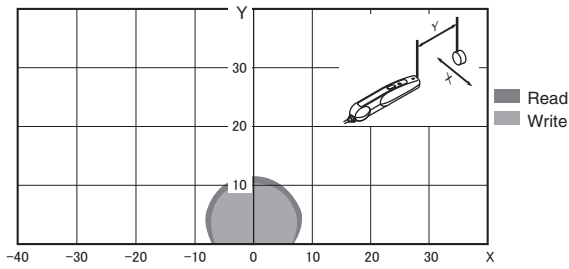

● V680-D1KP53M

Embedded in metal (iron)

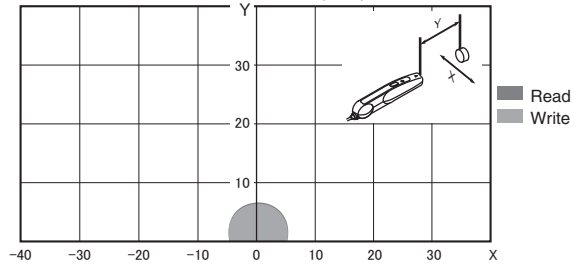

● V680-D1KP66T

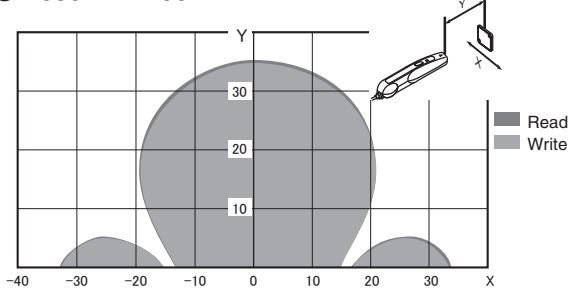

● V680-D1KP66T-SP

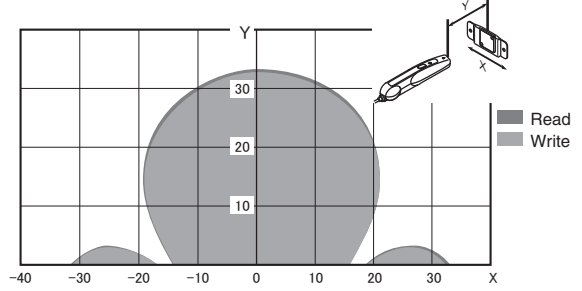

● V680-D1KP66MT

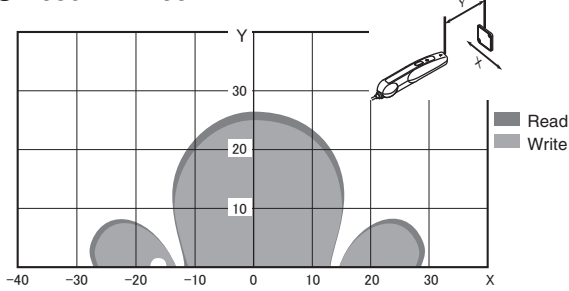

● V680-D1KP58HT

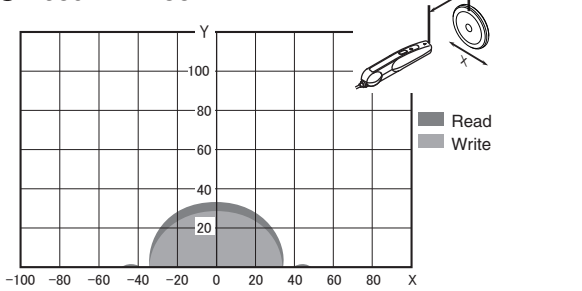

● V680-D2KF52M

• Read / Write

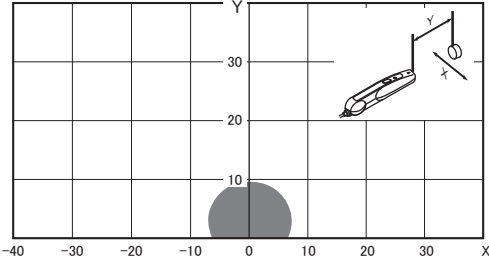

● V680-D2KF52M

• Read / Write Embedded in metal (iron)

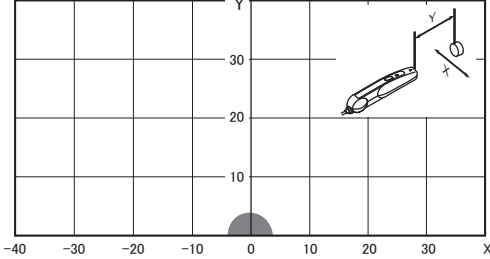

● V680-D8KF67

• Read / Write

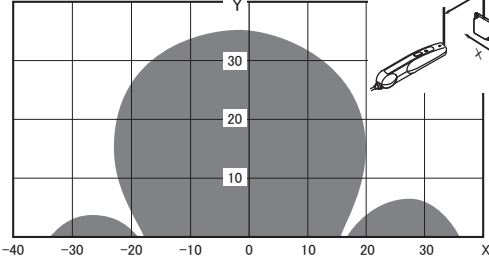

● V680-D8KF67M

• Read / Write

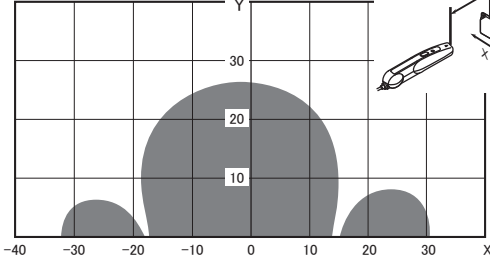

● V680-D8KF68/V680-D32KF68

• Read / Write

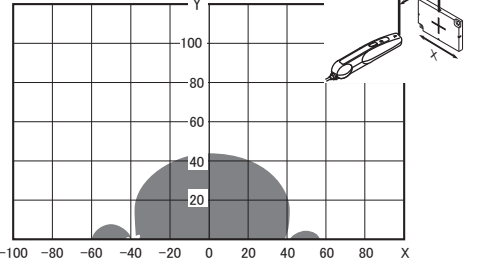

● V680S-D2KF67

• Read / Write

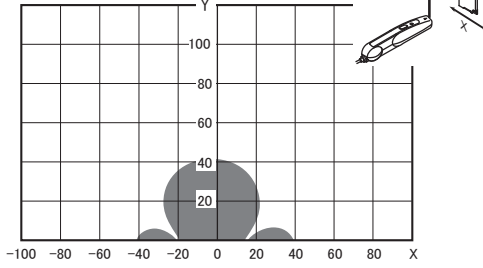

● V680S-D2KF67M

• Read / Write

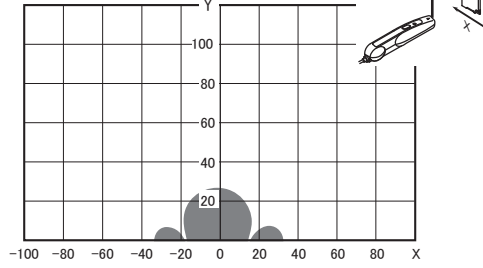

● V680S-D2KF68

• Read / Write

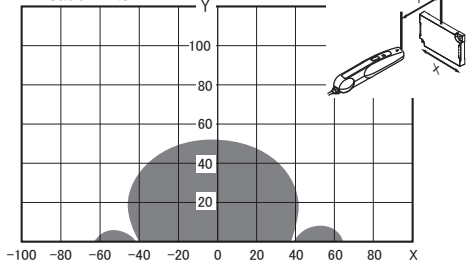

● V680S-D2KF68M

• Read / Write

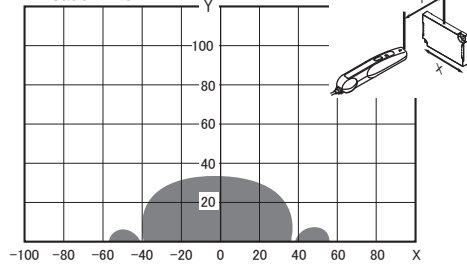

● V680S-D8KF67

• Read / Write

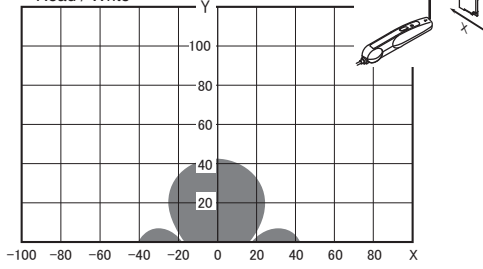

● V680S-D8KF67M

• Read / Write

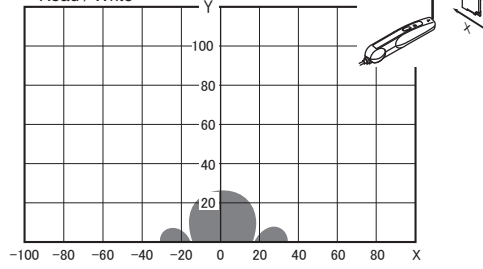

● V680S-D8KF68

• Read / Write

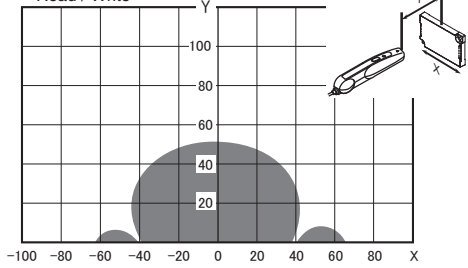

● V680S-D8KF68M

• Read / Write

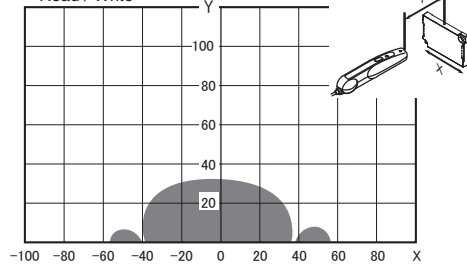

Communications Time

TAT represents the total time from when a command is first sent from the host device until a response is received. The communication time represents the time required for communications between the Hand-held Reader/Writer and the RF Tag, not including communications with the host device.

Example

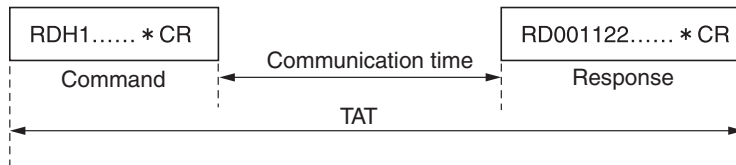

■ V680-D1KP52MT/V680-D1KP66MT/V680-D1KP66T/V680-D1KP58HT

■ V680-CH1D TAT

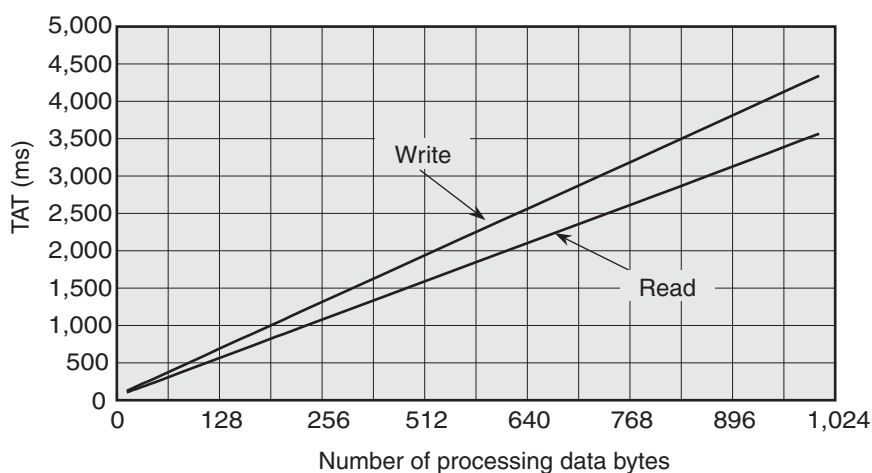

Note 1) In V680 mode, communications specifications for TAT data with the host device represent values with a baud rate of 9,600 bps, a bit length of 8 bits, 1 stop bit, and even parity. In this example, characters are sent consecutively, with no spaces between them.

2) The number of bytes in the TAT data is the number for hexadecimal encoding.

■ V680-CHUD TAT

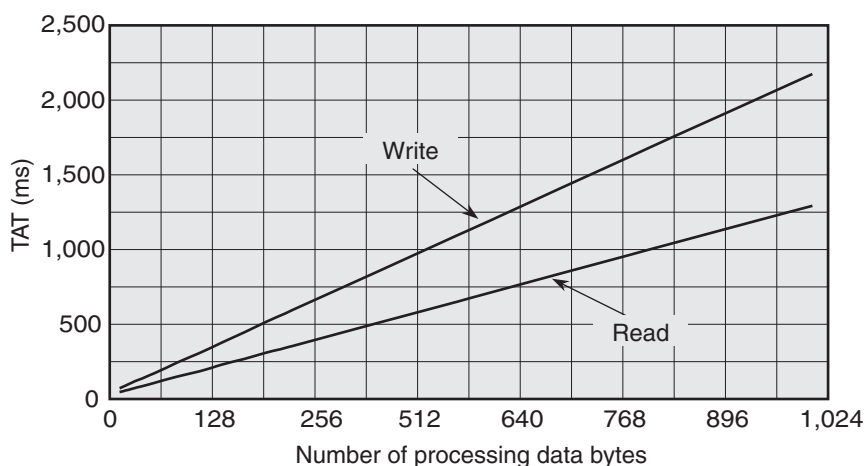

▪ Communication Time

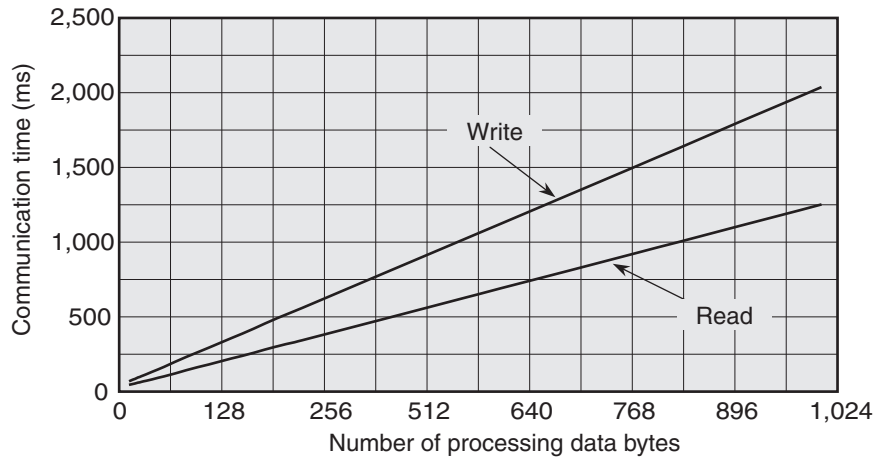

Calculation Method

Operation	Communication time (ms)
Read	$T=1.2N+27.3$
Write	$T=2.0N+414.4$

N: Number of processing data bytes

■ V680-D2KF52M/V680S-D2KF6@

▪ V680-CH1D TAT

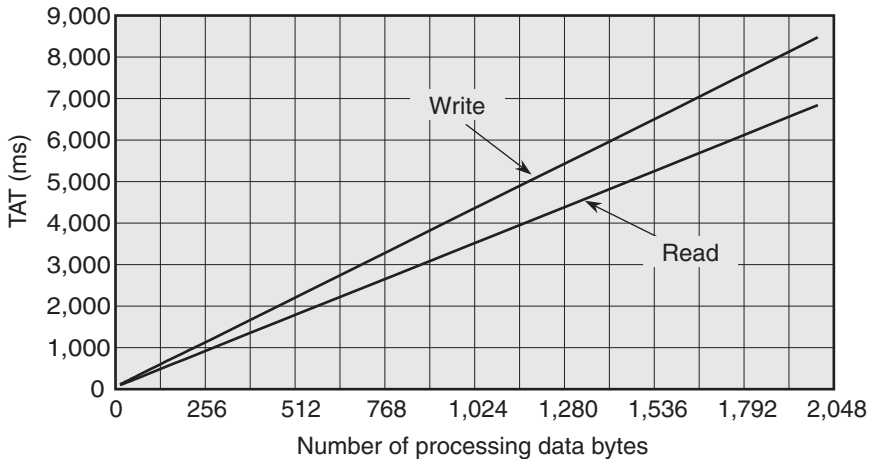

- Note 1) In V680 mode, communications specifications for TAT data with the host device represent values with a baud rate of 9,600 bps, a bit length of 8 bits, 1 stop bit, and even parity. In this example, characters are sent consecutively, with no spaces between them.
- 2) The number of bytes in the TAT data is the number for hexadecimal encoding.

▪ V680-CHUD TAT

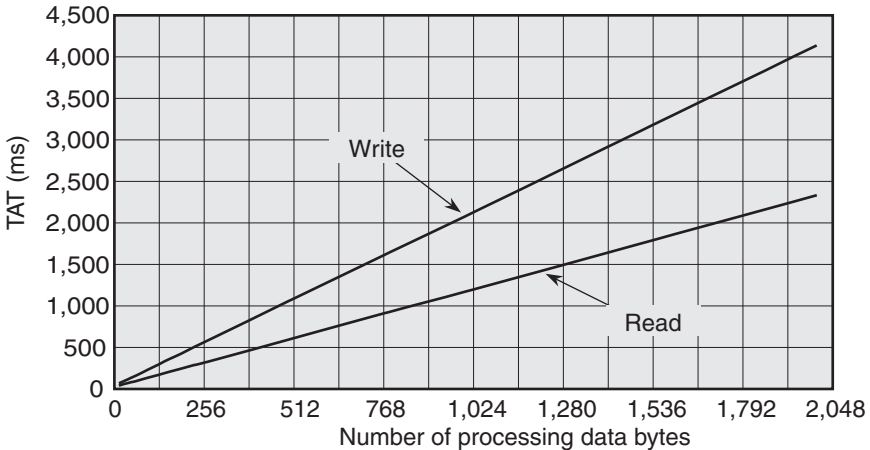

▪ Communication Time

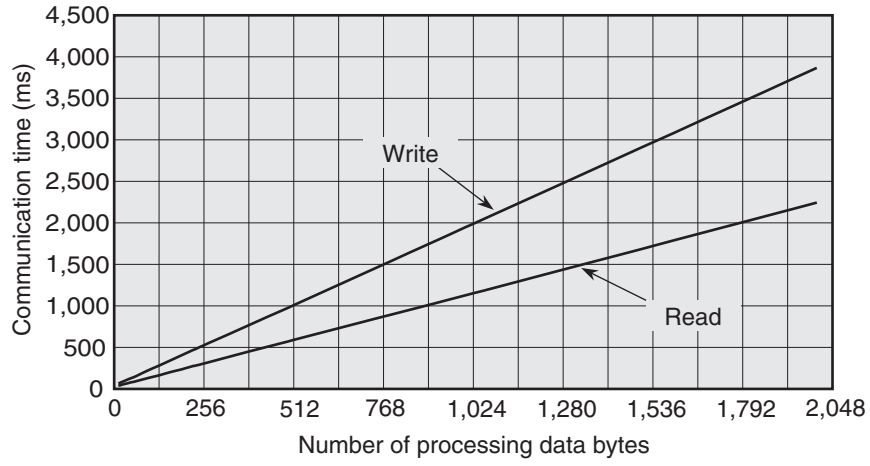

Calculation Method

Operation	Communication time (ms)
Read	$T=1.1N+26.1$
Write	$T=1.9N+40.3$

N: Number of processing data bytes

■ V680-D8KF68/V680-D32KF68

▪ V680-CH1D TAT

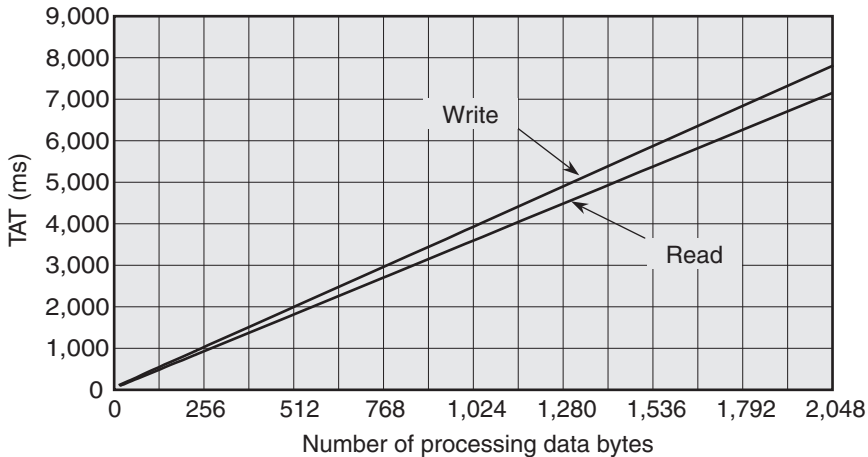

- Note 1) In V680 mode, communications specifications for TAT data with the host device represent values with a baud rate of 9,600 bps, a bit length of 8 bits, 1 stop bit, and even parity. In this example, characters are sent consecutively, with no spaces between them.
- 2) The number of bytes in the TAT data is the number for hexadecimal encoding.

▪ V680-CHUD TAT

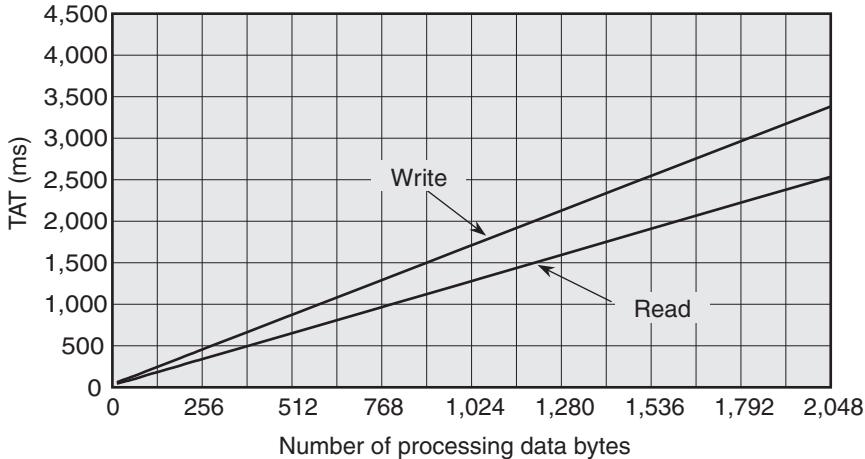

▪ Communication Time

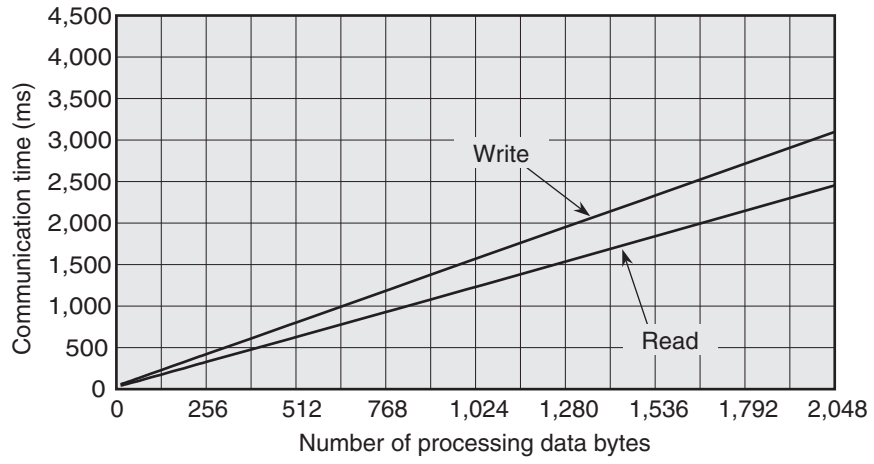

Calculation Method

Operation	Communication time (ms)
Read	$T=1.2N+27.7$
Write	$T=1.5N+41.4$

N: Number of processing data bytes

■ V680S-D8KF6@

▪ V680-CH1D TAT

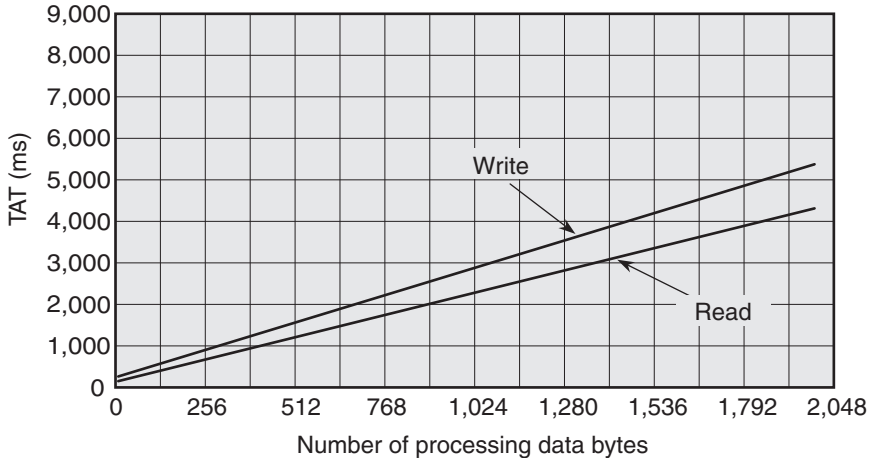

- Note 1) In V680 mode, communications specifications for TAT data with the host device represent values with a baud rate of 9,600 bps, a bit length of 8 bits, 1 stop bit, and even parity. In this example, characters are sent consecutively, with no spaces between them.
- 2) The number of bytes in the TAT data is the number for hexadecimal encoding.

▪ V680-CHUD TAT

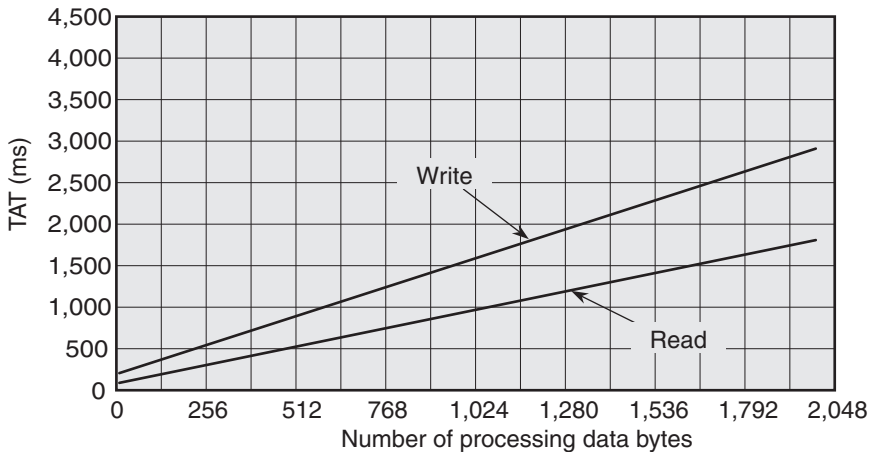

▪ Communication Time

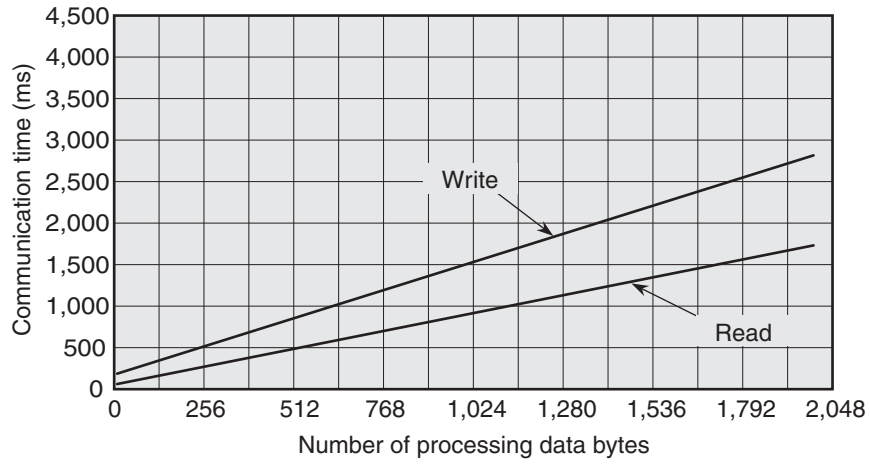

Calculation Method

Operation	Communication time (ms)
Read	$T=0.8N+45$
Write	$T=1.3N+167$

N: Number of processing data bytes

RF Tag Memory Map

■ V680-D1KP@@

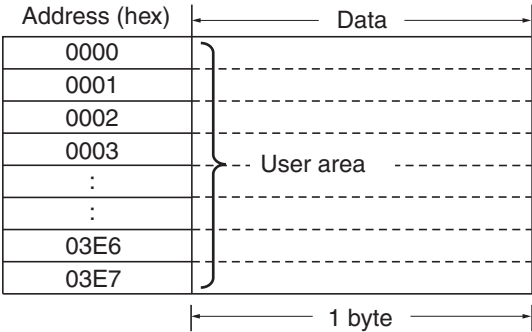

■ V680-D2KF@@ and V680S-D2KF6@

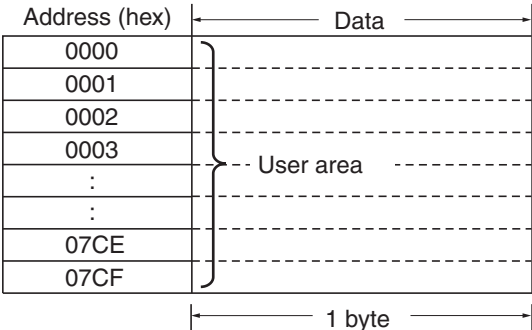

■ V680-D8KF68 and V680S-D8KF6@

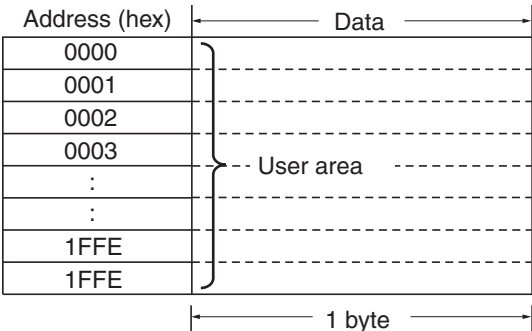

■ V680-D32KF68

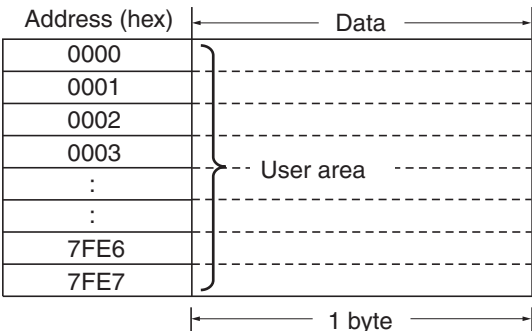

For more information on RF Tag memory capacity and memory type, refer to *RF Tag Memory Capacities and Memory Types (V680 Series)*.

RF Tag Memory Capacities and Memory Types (V680 Series)

(As of February 2024)

Model	Memory capacity (user memory)	Memory type	Life expectancy
V680-D1KP52MT V680-D1KP66T V680-D1KP66MT	1,000 bytes	EEPROM	Write endurance: 100,000 times per block (25°C) Data retention: 10 years after writing (85°C or less)
V680-D1KP58HT			Write endurance: 100,000 times per block (25°C) Data retention: 10 years after writing (85°C or less) Note: Data can be retained at temperatures exceeding 110°C for a cumulative total of 10 hours.
V680-D2KF52M	2,000 bytes	FRAM	Access frequency: One trillion times Data retention: 10 years after writing (85°C or less)
V680-D8KF67 V680-D8KF67M V680-D8KF68	8,192 bytes		Access frequency: 10 billion times Data retention: 10 years after writing (70°C or less)
V680-D32KF68	32,744 bytes		
V680S-D2KF67 V680S-D2KF67M V680S-D2KF68 V680S-D2KF68M	2,000 bytes		Access frequency: One trillion times Data retention: 10 years after writing (85°C or less)
V680S-D8KF67 V680S-D8KF67M V680S-D8KF68 V680S-D8KF68M	8,192 bytes	FRAM	

Note: For details, refer to the following manuals.

Model	Manual name	Man. No.
V680-D1KP52MT V680-D1KP53M V680-D1KP66T V680-D1KP66MT	V680-series RFID System User's Manual for Amplifiers, Antennas, and RF Tags (EEPROM model)	Z262
V680-D1KP58HT	V680-series Heat-resistive RFID System User's Manual	Z221
V680-D1KP58HTN	V680-series RFID System User's Manual for Amplifiers, Antennas, and RF Tags (EEPROM model)	Z262
V680-D2KF52M V680-D8KF67 V680-D8KF67M V680-D8KF68 V680-D32KF68 V680S-D2KF67 V680S-D2KF67M V680S-D2KF68 V680S-D2KF68M V680S-D8KF67 V680S-D8KF67M V680S-D8KF68 V680S-D8KF68M	V680-series RFID System User's Manual for Amplifiers, Antennas, and RF Tags (FRAM)	Z248

List of ASCII Characters

Left digit Right digit	b8 to b5	0000	1001	0010	0011	0100	0101	0110	0111	1000	1101	1010	1011	1100	1101	1110	1111	
	b4 to b1	Col- umn Row	0	1	2	3	4	5	6	7	8	9	10	11	12	13	14	15
0000	0	NUL	TC ₇ (DLE)	(SP)	0	@	P	`	p	Undefined	Undefined	Undefined	Undefined	Undefined	Undefined	Undefined	Undefined	Undefined
0001	1	TC ₁ (SOH)	DC ₁	!	1	A	Q	a	q									
0010	2	TC ₂ (STX)	DC ₂	"	2	B	R	b	r									
0011	3	TC ₃ (ETX)	DC ₃	#	3	C	S	c	s									
0100	4	TC ₄ (EOT)	DC ₄	\$	4	D	T	d	t									
0101	5	TC ₅ (NEQ)	TC ₈ (NAK)	%	5	E	U	e	u									
0110	6	TC ₆ (ACK)	TC ₉ (SYN)	&	6	F	V	f	v									
0111	7	BEL	TC ₁₀ (ETB)	'	7	G	W	g	w									
1000	8	FE ₀ (BS)	CAN	(8	H	X	h	x									
1001	9	FE ₁ (HT)	EM)	9	I	Y	i	y									
1010	10	FE ₂ (LF)	SUB	*	:	J	Z	j	z									
1011	11	FE ₃ (VT)	ESC	+	;	K	[k	{									
1100	12	FE ₄ (FF)	IS ₄ (FS)	,	<	L	\	l										
1101	13	FE ₅ (CR)	IS ₃ (GS)	-	=	M]	m	}									
1110	14	SO	IS ₂ (RS)	.	>	N	^	n	-									
1111	15	SI	IS ₁ (US)	/	?	O	-	o	DEL									

Note 1: The item in column 5, row 12 is a backlash (\) in ASCII.

2: Do not use the undefined areas.

Degree of Protection

International protection degrees (IP-@@) are determined by the following tests. Be sure to check the sealing capability under the actual operating environment and conditions before actual use.

■ IEC (International Electrotechnical Commission) Standards (IEC60529 November 2001)

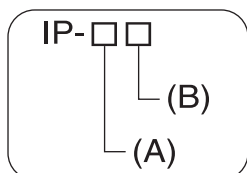









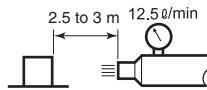

Degree of Protection from Solid Materials

Degree	Protection	
0		No protection
1		Protects against penetration of any solid object such as a hand that is 50 mm or more in diameter.
2		Protects against penetration of any solid object, such as a finger, that is 12.5 mm or more in diameter.
3		Protects against penetration of any solid object, such as a wire, that is 2.5 mm or more in diameter.
4		Protects against penetration of any solid object, such as a wire, that is 1 mm or more in diameter.
5		Protects against penetration of dust of a quantity that may cause malfunction or obstruct the safe operation of the product.
6		Protects against penetration of all dust.

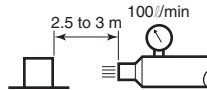
Degree of Protection Against Water

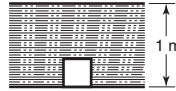
Degree	Protection		Test method (with fresh water)
0	No protection	Not protected against water.	No test
1	Protection against water drops 	Protects against vertical drops of water towards the product.	Water is dropped vertically towards the product from the test machine for 10 min.
2	Protection against water drops 	Protects against drops of water approaching at a maximum angle of 15° to the left, right, back, and front of vertical towards the product.	Water is dropped for 2.5 min each (i.e., 10 min in total) towards the product inclined 15° to the left, right, back, and front from the test machine.

Degree	Protection		Test method (with fresh water)
3	Protection against sprinkled water 	Protects against sprinkled water approaching at a maximum angle of 60° from vertical towards the product.	Water is sprinkled at a maximum angle of 60° to the left and right from vertical for 10 min from the test machine.  Water rate is 0.07 liter/min per hole.
4	Protection against water spray 	Protects against water spray approaching at any angle towards the product.	Water is sprayed at any angle towards the product for 10 min from the test machine.  Water rate is 0.07 liter/min per hole.
5	Protection against water jet spray 	Protects against water jet spray approaching at any angle towards the product.	Water is jet sprayed at any angle towards the product for 1 min per square meter for at least 3 min in total from the test machine.  Discharging nozzle: 6.3 dia.
6	Protection against high pressure water jet spray 	Protects against high-pressure water jet spray approaching at any angle towards the product.	Water is jet sprayed at any angle towards the product for 1 min per square meter for at least 3 min in total from the test machine.  Discharging nozzle: 12.5 dia.
7	Protection underwater 	Resists the penetration of water when the product is placed underwater at specified pressure for a specified time.	The product is placed 1 m deep in water (if the product is 850 mm max. in height) for 30 min. 
8 (See note.)	Protection underwater 	Can be used continuously underwater.	The test method is determined by the manufacturer and user.

Note: OMRON Test Method

Usage condition: 10 m or less under water in natural conditions

1. No water ingress after 1 hour under water at 2 atmospheres of pressure.
2. Sensing distance and insulation resistance specifications must be met after 100 repetitions of half hour in 5°C water and half hour in 85°C water.

About IPX9K

IPX9K is a protection standard regarding high temperature and high-pressure water which is defined by the German standard (DIN 40050 PART9).

Water is sprayed on 80 °C hot water with the water pressure of 80 to 100BAR from a nozzle to the test piece.

Amount of water is 14 to 16 liters/minute.

The distance between the test piece and a nozzle is 10 to 15 cm, and the directions of water-drainage are 0 degrees, 30 degrees, 60 degrees, and 90 degrees horizontally.

They are evaluated with the test piece is rotating on a horizontal plane by 30 seconds in each direction.

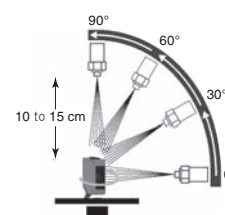

Oil resistance (OMRON in-house standard)

Protection	
Oil-resistant	No adverse affect from oil drops or oil spray approaching from any direction.
Oil-proof	Protects against penetration of oil drops or oil spray approaching from any direction.

Note. Oil resistance has been tested using a specific oil as defined in the OMRON test method. (JIS C 0920:2003, Appendix 1)

Revision History

A manual revision code appears as a suffix to the catalog number at the bottom of the front and rear pages.

Man. No. Z272-E1-08

↑
Revision code

Revision code	Date	Revised contents
01	November 2007	Original production
02	September 2008	Added information on installing the USB driver for Vista.
03	August 2010	Added information on the V680-D1KP53M/-D8KF67/-D8KF67M/-D1KP58HT. Added information on international standards and certification. Made other minor corrections.
03A	January 2011	Minor corrections (p.59)
04	February 2014	Added items for V680S-D2KF67/-D2KF67M/-D2KF68/-D2KF68M RF Tags. Deleted items for V680-D2KF67 RF Tags. and made other minor corrections.
04A	April 2014	Changed the type of Hand-held Terminal manufactured by Motorola Solutions, Inc.
05	October 2014	Added items for V680S-D8KF67/-D8KF67M/-D8KF68/-D8KF68M RF Tags. and made other minor corrections.
06	March 2015	Changed the type of Hand-held Terminal manufactured by Zebra Technologies, Inc.
07	January 2019	Added installation method on Windows 10 to "Installing the USB Driver". Deleted installation method on Windows Vista from "Installing the USB Driver".
08	February 2024	Correct mistakes in Life expectancy of V680-D2KF52M.

OMRON Corporation Industrial Automation Company

Kyoto, JAPAN

Contact : www.ia.omron.com

Regional Headquarters

OMRON EUROPE B.V.

Wegalaan 67-69, 2132 JD Hoofddorp
The Netherlands
Tel: (31) 2356-81-300 Fax: (31) 2356-81-388

OMRON ELECTRONICS LLC

2895 Greenspoint Parkway, Suite 200
Hoffman Estates, IL 60169 U.S.A.
Tel: (1) 847-843-7900 Fax: (1) 847-843-7787

OMRON ASIA PACIFIC PTE. LTD.

438B Alexandra Road, #08-01/02 Alexandra
Technopark, Singapore 119968
Tel: (65) 6835-3011 Fax: (65) 6835-3011

OMRON (CHINA) CO., LTD.

Room 2211, Bank of China Tower,
200 Yin Cheng Zhong Road,
PuDong New Area, Shanghai, 200120, China
Tel: (86) 21-6023-0333 Fax: (86) 21-5037-2388

Authorized Distributor:

©OMRON Corporation 2007 - 2024 All Rights Reserved.
In the interest of product improvement,
specifications are subject to change without notice.

Cat. No. Z272-E1-08 0224 (1107)