

Operation Software

CNC Operator

Operation Manual

SYSMAC-RTNC□□□□□

NOTE

All rights reserved. No part of this publication may be reproduced, stored in a retrieval system, or transmitted, in any form, or by any means, mechanical, electronic, photocopying, recording, or otherwise, without the prior written permission of OMRON.

No patent liability is assumed with respect to the use of the information contained herein. Moreover, because OMRON is constantly striving to improve its high-quality products, the information contained in this manual is subject to change without notice. Every precaution has been taken in the preparation of this manual. Nevertheless, OMRON assumes no responsibility for errors or omissions. Neither is any liability assumed for damages resulting from the use of the information contained in this publication.

Trademarks

- Sysmac and SYSMAC are trademarks or registered trademarks of OMRON Corporation in Japan and other countries for OMRON factory automation products.
- Microsoft, Windows, Windows Vista, Excel, Visual Basic, and Microsoft Edge are either registered trademarks or trademarks of Microsoft Corporation in the United States and other countries.
- EtherCAT® is registered trademark and patented technology, licensed by Beckhoff Automation GmbH, Germany.
- ODVA, CIP, CompoNet, DeviceNet, and EtherNet/IP are trademarks of ODVA.
- The SD and SDHC logos are trademarks of SD-3C, LLC. 
- Celeron, Intel and Intel Core are trademarks of Intel Corporation in the U.S. and / or other countries.

Other company names and product names in this document are the trademarks or registered trademarks of their respective companies.

Copyrights

Microsoft product screen shots used with permission from Microsoft.

Introduction

Thank you for purchasing the software CNC Operator for the Sysmac NJ/NY-series NC integrated controller (hereinafter referred to as CNC Controller).

The CNC Operator software enables your PC or IPC to be used as the operator console of the CNC Controller.

This manual describes how to operate CNC Operator when primarily using the CNC Controller.

Use this manual together with the user's manuals for the other devices that you use.

Intended Audience

This manual is intended for the following personnel, who must also have knowledge of electrical systems (an electrical engineer or the equivalent).

- Personnel in charge of introducing FA systems.
- Personnel in charge of designing FA systems.
- Personnel in charge of installing and maintaining FA systems.
- Personnel in charge of managing FA systems and facilities.

For the NC programming language, this manual is intended for personnel who understand the programming language specifications in international standard ISO6983-1 or Japanese standard JIS 6315.

For other programming languages, this manual is intended for personnel who understand the programming language specifications in international standard IEC 61131-3 or Japanese standard JIS B 3503.

Notice

This manual contains information that is necessary to use CNC Operator. Please read and understand this manual before using the software. Keep this manual in a safe place where it will be available for reference during operation.

Manual Structure

Page Structure

The following page structure and symbols are used in this user's manual.

The diagram illustrates a page from a manual with various structural elements and their functions:

- Level 1 heading:** Points to the top navigation bar containing "4 Installation and Wiring".
- Level 2 heading:** Points to the section title "4-3 Mounting Units".
- Level 3 heading:** Points to the sub-section title "4-3-1 Connecting Controller Components".
- Step in a procedure:** Points to the numbered step "1 Join the Units so that the connectors fit exactly.".
- Special information:** Points to the "Precautions for Correct Use" section, which includes a warning icon and text about locking sliders.
- Page tab:** Points to the tab labeled "4" on the right side of the page.
- Manual name:** Points to the footer text "NJ-series CPU Unit Hardware User's Manual (W500)".

Additional annotations on the right side of the diagram:

- Level 3 heading Gives the current headings.
- Page tab Gives the number of the main section.

Note This illustration is provided only as a sample. It may not literally appear in this manual.

Special Information

Special information in this manual is classified as follows:



Precautions for Safe Use

Precautions on what to do and what not to do to ensure safe usage of the product.



Precautions for Correct Use

Precautions on what to do and what not to do to ensure proper operation and performance.



Additional Information

Additional information to read as required.

This information is provided to increase understanding or make operation easier.



Version Information

Information on differences in specifications and functionality for CPU Units with different unit versions and for different versions of the Sysmac Studio is given.

Precaution on Terminology

- For terminology related to the CPU unit and controller used in this manual, refer to the terminology explained in the *NJ/NX-series CPU Unit Software User's Manual* (Cat. No. W501), *NJ/NY-Series NC Integrated Controller User's Manual* (Cat. No. O030), or *NY-series IPC Machine Controller Industrial Panel PC / Industrial Box PC Software User's Manual* (Cat. No. W558).
- In this manual, "download" refers to transferring data from CNC Operator to the physical Controller.
- In this manual, the controller feature that is integrated in the NY-series Industrial PC may be referred to as an NY-series Controller.
- CNC Operator supports the NJ/NY-series Controllers. Unless another Controller series is specified, the operating procedures and screen captures used in the manual are examples for the NJ-series CNC Controllers.

Terminology

For descriptions of the Controller terms that are used in this manual, refer to information on terminology in the manuals that are listed in *Related Manuals* on page 18.

Sections in this Manual

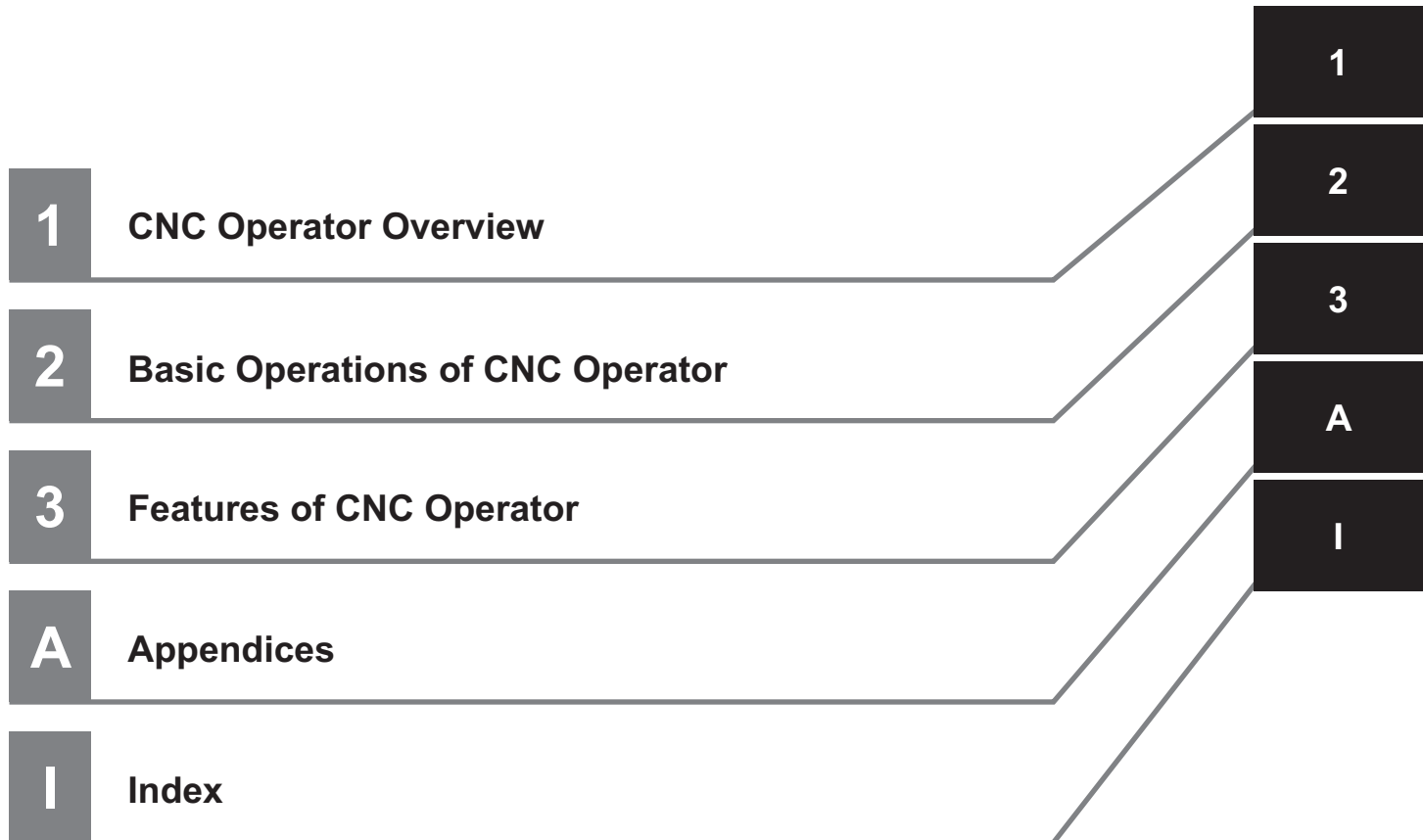

CONTENTS

Introduction	1
Intended Audience	1
Notice.....	1
Manual Structure	2
Page Structure.....	2
Special Information	3
Precaution on Terminology	3
Terminology	3
Sections in this Manual	5
Terms and Conditions Agreement.....	8
Safety Precautions	9
Definition of Precautionary Information.....	9
Symbols.....	10
Precautions for Safe Use	12
Precautions for Correct Use.....	13
Regulations and Standards.....	14
Software Licenses and Copyrights	14
Versions	15
Checking Versions	15
Related Manuals	18
Revision History	21

Section 1 CNC Operator Overview

1-1 What is CNC Operator?.....	1-2
-----------------------------------	-----

Section 2 Basic Operations of CNC Operator

2-1 Installation.....	2-2
2-1-1 System requirement	2-2
2-1-2 Installation Procedure	2-2
2-1-3 Uninstallation Procedure	2-3
2-2 System Design.....	2-4
2-2-1 Basic Design Flow.....	2-4
2-2-2 Outline of System Design.....	2-5

Section 3 Features of CNC Operator

3-1 Starting and Exiting CNC Operator.....	3-3
3-2 User Interface.....	3-4
3-3 Features and Settings of CNC Operator.....	3-8

3-3-1	CNC Controller Connection Settings	3-8
3-3-2	Axis Settings	3-10
3-3-3	Tool Status	3-12
3-3-4	NC Program Status.....	3-12
3-3-5	G Codes (Modal Group)	3-13
3-3-6	Display and Pin Display of Setting Items	3-14
3-3-7	General Application Settings.....	3-15
3-3-8	Message Log	3-25
3-3-9	Memo Function	3-25
3-3-10	Common Functions.....	3-25
3-4	Function Execution Conditions and Operating Modes.....	3-26
3-5	Tool Offsets/Workpiece Offsets	3-29
3-5-1	Tool Offset Management.....	3-29
3-5-2	Work Offset Management.....	3-30
3-6	NC Programs.....	3-32
3-6-1	AUTO	3-32
3-6-2	Full Screen Editor	3-34
3-6-3	NC Subprograms	3-35
3-6-4	Queue	3-36
3-7	MDI (Manual Data Input).....	3-37
3-7-1	Switching Modes.....	3-37
3-7-2	Vertical button bar.....	3-39
3-7-3	Soft Control Panel (Velocity Override).....	3-43
3-7-4	Manual Mode	3-45
3-8	Test Run	3-47
3-8-1	CNC Motor Compensation.....	3-47
3-8-2	Correction of NC Program	3-48
3-8-3	Simulation	3-48
3-9	Field Operation	3-49
3-9-1	Connection with CNC Controller.....	3-49
3-9-2	Display of the Running Program and the Path	3-49
3-9-3	Login User Information	3-50
3-9-4	Functions to Change Screen Display	3-50
3-9-5	Alarms.....	3-51
3-9-6	Message Status Bar	3-51
3-9-7	Watchdog Indicator	3-51
3-9-8	NC Parameter Window	3-52
3-9-9	Axis Parameter Window	3-53
3-10	Troubleshooting	3-54
3-10-1	Event Viewer.....	3-54
3-10-2	Back Trace.....	3-55
3-11	Starting from the Sysmac Studio.....	3-56

Appendices

A-1	Customization by SDK.....	A-2
A-2	Setting SYSMAC Gateway, Communications Middleware.....	A-3
A-3	Heartbeat Configuration Example.....	A-7

Index

Terms and Conditions Agreement

● WARRANTY

- The warranty period for the Software is one year from the date of purchase, unless otherwise specifically agreed.
- If the User discovers defect of the Software (substantial non-conformity with the manual), and return it to OMRON within the above warranty period, OMRON will replace the Software without charge by offering media or download from OMRON's website. And if the User discovers defect of media which is attributable to OMRON and return it to OMRON within the above warranty period, OMRON will replace defective media without charge. If OMRON is unable to replace defective media or correct the Software, the liability of OMRON and the User's remedy shall be limited to the refund of the license fee paid to OMRON for the Software.

● LIMITATION OF LIABILITY

- THE ABOVE WARRANTY SHALL CONSTITUTE THE USER'S SOLE AND EXCLUSIVE REMEDIES AGAINST OMRON AND THERE ARE NO OTHER WARRANTIES, EXPRESSED OR IMPLIED, INCLUDING BUT NOT LIMITED TO, WARRANTY OF MERCHANTABILITY OR FITNESS FOR PARTICULAR PURPOSE. IN NO EVENT, OMRON WILL BE LIABLE FOR ANY LOST PROFITS OR OTHER INDIRECT, INCIDENTAL, SPECIAL OR CONSEQUENTIAL DAMAGES ARISING OUT OF USE OF THE SOFTWARE.
- OMRON SHALL HAVE NO LIABILITY FOR DEFECT OF THE SOFTWARE BASED ON MODIFICATION OR ALTERNATION TO THE SOFTWARE BY THE USER OR ANY THIRD PARTY. OMRON SHALL NOT BE RESPONSIBLE AND/OR LIABLE FOR ANY LOSS, DAMAGE, OR EXPENSES DIRECTLY OR INDIRECTLY RESULTING FROM THE INFECTION OF OMRON PRODUCTS, ANY SOFTWARE INSTALLED THEREON OR ANY COMPUTER EQUIPMENT, COMPUTER PROGRAMS, NETWORKS, DATABASES OR OTHER PROPRIETARY MATERIAL CONNECTED THERETO BY DISTRIBUTED DENIAL OF SERVICE ATTACK, COMPUTER VIRUSES, OTHER TECHNOLOGICALLY HARMFUL MATERIAL AND/OR UNAUTHORIZED ACCESS.
- OMRON SHALL HAVE NO LIABILITY FOR SOFTWARE DEVELOPED BY THE USER OR ANY THIRD PARTY BASED ON THE SOFTWARE OR ANY CONSEQUENCE THEREOF.

● APPLICABLE CONDITIONS

USER SHALL NOT USE THE SOFTWARE FOR THE PURPOSE THAT IS NOT PROVIDED IN THE ATTACHED USER MANUAL.

● CHANGE IN SPECIFICATION

The software specifications and accessories may be changed at any time based on improvements and other reasons.

● ERRORS AND OMISSIONS

The information in this manual has been carefully checked and is believed to be accurate; however, no responsibility is assumed for clerical, typographical, or proofreading errors, or omissions.



Safety Precautions

Definition of Precautionary Information

The following notation is used in this manual to provide precautions required to ensure safe usage of CNC Operator and the CNC Controller.

The safety precautions that are provided are extremely important to ensure safety. Always read and heed the information provided in all safety precautions.

The following notation is used.

 WARNING	Indicates a potentially hazardous situation which, if not avoided, could result in death or serious injury. Additionally, there may be severe property damage.
 Caution	Indicates a potentially hazardous situation which, if not avoided, may result in minor or moderate injury, or property damage.



Precautions for Safe Use

Indicates precautions on what to do and what not to do to ensure safe usage of the product.



Precautions for Correct Use

Indicates precautions on what to do and what not to do to ensure proper operation and performance.

Symbols



The circle and slash symbol indicates operations that you must not do.
 The specific operation is shown in the circle and explained in text.
 This example indicates prohibiting disassembly.



The triangle symbol indicates precautions (including warnings).
 The specific operation is shown in the triangle and explained in text.
 This example indicates a precaution against electric shock.



The triangle symbol indicates precautions (including warnings).
 The specific operation is shown in the triangle and explained in text.
 This example indicates a general precaution.



The filled circle symbol indicates operations that you must do.
 The specific operation is shown in the circle and explained in text.
 This example shows a general precaution for something that you must do.

WARNING

Check the NC program for proper execution before you use it for actual operation.



Check the parameters for proper execution before you use them for actual operation.



Always confirm safety at the destination node before you transfer an NC program from CNC Operator.



The devices or machines may perform unexpected operations regardless of the operating mode of the CPU Unit.

If you disconnect the USB dongle during operation, CNC Operator stops operating. In the controller program, configure a control circuit to safely stop the system even if CNC Operator stops operating. For example, it should execute heartbeat processing between CNC Operator and the controller, and stop the system when the heartbeat is lost. Accidents may occur if the system performs unexpected operations. For the detailed heartbeat configuration method, refer to *A-3 Heartbeat Configuration Example* on page A-7.



 **Caution**

Although the Simulator simulates the operation of the Controller, there are difference from the Controller in operation and timing.

After you debug the user program on the Simulator, always check operations on the physical Controller before you use the user program to operate the controlled system.



Accidents may occur if the system performs unexpected operations.

Always confirm safety before you reset the system.



Always confirm safety at the destination node before you transfer an NC program to a node.

Not doing so may result in injury.



Precautions for Safe Use

Operation

- Confirm that no adverse effect will occur in the system before you attempt any of the following.
 - Changing operating modes (edit, MANUAL AUTO, MDI) by CNC Operator, including operating mode setting upon power-ON.
 - Changing NC program or settings (tool offset, work offset, CNC motor compensation table, etc.)
- When changing a CNC motor compensation table data in the CPU Unit, store the data on the retained type memory or save it to a file, so that the data will be loaded when the power is turned ON again. Otherwise, the previous status will be restored when the power is turned on again, which may cause an unexpected machine operation to occur.

Manual Operation

- Confirm the target coordinate system and axis number carefully before you run manual operation (jog, spindle operation).
- Manual operation (jog, spindle operation) involves motor operation. Refer to the operation manual before you run manual operation.
Be particularly careful of the following points.
 - Confirm safety around all moving parts.
 - When you click the **Run** button, the motor begins actual operation at the specified speed. Only begin motor operation if you are absolutely sure there is no danger if you start the motor.
 - Always have an external emergency stop device available.
 - Sometimes you may be unable to stop the motor from your computer. Install an external emergency stop device so that you can stop the motor immediately if needed.
 - Operate the motor only when you can clearly confirm the motor operation so that you can react quickly in the case of any danger that may arise due to operation of the motor.
 - A communications error will occur if you attempt to begin operations without EtherCAT communications. Always establish EtherCAT communications first.
- Be aware of all the precautions that you need to take during manual operation.
 - During manual operation, only the tool has any control of the operation. Any commands from motion control instructions or CNC control instructions are ignored.

If communications are interrupted between the CNC Operator and Controller during test run operations, you will not be able to stop the motor from the computer. Provide an external hardware means that you can use to stop the motor without fail.

Automatic Operation and MDI

- Executing Feed Hold Reset automatically returns the system to the feed hold stop position at rapid feed. Confirm that there are no obstacles on the return path before you execute Feed Hold Reset.

Precautions for Correct Use

- Observe the following precautions when you start CNC Operator.
 - Exit all applications that are not necessary to use CNC Operator. For virus checker or other software that could affect the startup and operations of CNC Operator, take measures such as to remove CNC Operator from the scope of virus checking.
 - If any hard disks or printers that are connected to the computer are shared with other computers on a network, isolate them so that they are no longer shared.
 - With some notebook computers, the default settings do not supply power to Ethernet port to save energy. There are energy-saving settings in Windows, and also sometimes in utilities or the BIOS of the computer. Refer to the user documentation for your computer and disable all energy-saving features.
 - When a change is made in the ini file, check that it will not affect facilities before starting CNC Operator.
 - Securely confirm program operations in the project, main program, sub program, and connected controller sides before starting the actual application system.
- While CNC Operator is running, be careful of the following points.
 - Do not exit CNC Operator while the equipment is running.
 - Do not download the NC program from CNC Operator while the NC program is running.

Regulations and Standards

Software Licenses and Copyrights

- This product incorporates certain third party software.

Versions

Unit versions are used to manage the hardware and software in NJ-series Units and EtherCAT slaves. The unit version is updated each time a change is made to hardware or software specifications. Even when two Units or EtherCAT slaves have the same model number, they will have functional or performance differences if they have different unit versions.

Checking Versions

You can check versions on the ID information indications or with the Sysmac Studio.

Checking Unit Versions on ID Information Indications

The version can be checked by reading the identification information label on the side of the product.

- **Checking the Unit Version of an NJ-series CPU Unit**

The ID information on the NJ501-5300 NJ CNC CPU Unit is shown below.

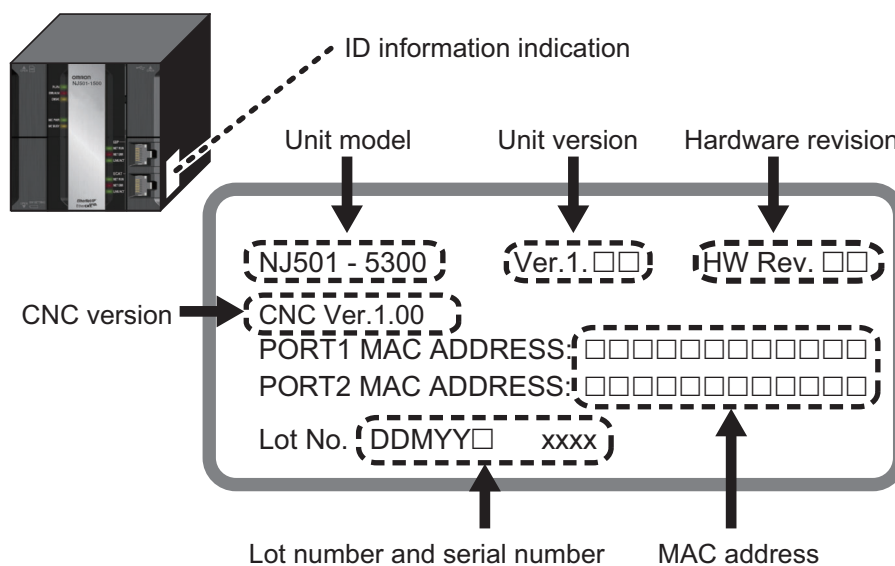

- **Checking the Unit Version of an NY-series CPU Unit**

The ID information on an NY-series NY5□2-5□□□ CPU Unit is shown below.

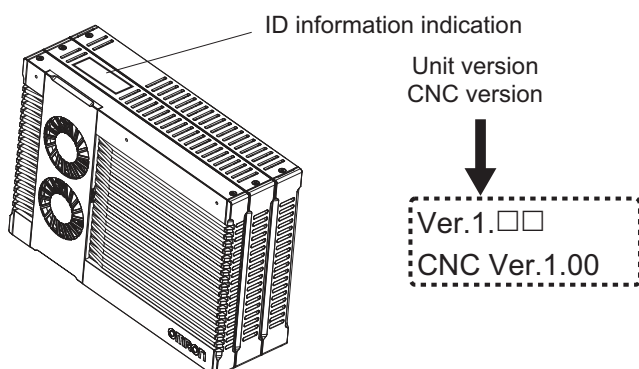

Checking Unit Versions with the Sysmac Studio

You can use the Sysmac Studio to check unit versions. The procedure is different for Units and for EtherCAT slaves.

● Checking the Unit Version of an NJ-series CPU Unit

You can use the Production Information while the Sysmac Studio is online to check the unit version of a Unit. You can do this for the CPU Unit, CJ-series Special I/O Units, and CJ-series CPU Bus Units. You cannot check the unit versions of CJ-series Basic I/O Units with the Sysmac Studio.

Use the following procedure to check the unit version.

- 1 Double-click **CPU/Expansion Racks** under **Configurations and Setup** in the Multiview Explorer. Or, right-click CPU/Expansion Racks under Configurations and Setup and select **Edit** from the menu.

The Unit Editor is displayed.

- 2 Right-click any open space in the Unit Editor and select *Production Information*.

The Production Information dialog box is displayed.

● Checking the Unit Version of an NY-series CPU Unit

You can use the Production Information while the Sysmac Studio is online to check the unit version of a Unit. You can only do this for the Controller.

- 1 Right-click **CPU Rack** under **Configurations and Setup - CPU/Expansion Racks** in the Multiview Explorer and select *Production Information*.

The Production Information dialog box is displayed.

● Changing Information Displayed in Production Information Dialog Box

- 1 Click the **Show Detail** or **Show Outline** button at the lower right of the **Production Information** dialog box.

The view will change between the production information details and outline.

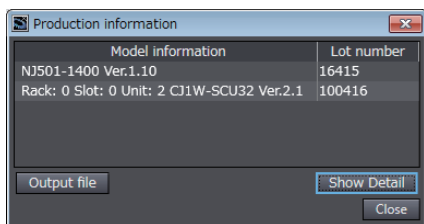

Outline View

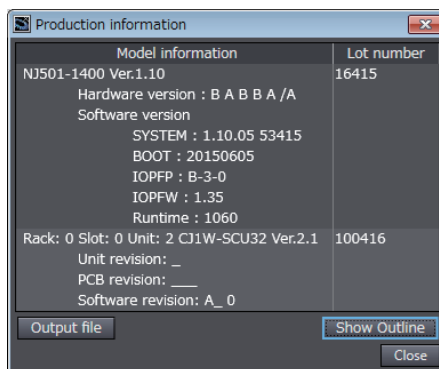

Detail View

The information that is displayed is different for the Outline View and Detail View. The Detail View displays the unit version, hardware version, and software versions. The Outline View displays only the unit version.

Note The hardware revision is separated by “/” and displayed on the right of the hardware version.

● **Checking the Unit Version of an EtherCAT Slave**

You can use the Production Information while the Sysmac Studio is online to check the unit version of an EtherCAT slave. Use the following procedure to check the unit version.

- 1 Double-click **EtherCAT** under **Configurations and Setup** in the Multiview Explorer. Otherwise, right-click **EtherCAT** under **Configurations and Setup**, and select *Edit*.

The EtherCAT Tab Page is displayed.

- 2 Right-click the master on the EtherCAT Tab Page and select *Display Production Information*.

The Production Information dialog box is displayed.

The unit version is displayed after "Rev."

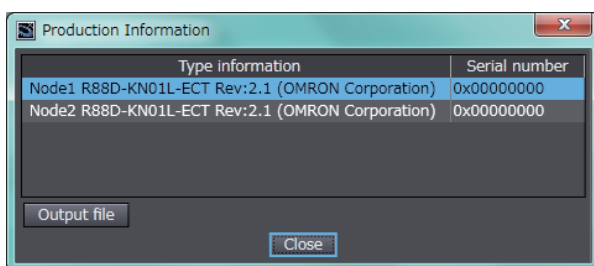

● **Changing Information Displayed in Production Information Dialog Box**

- 1 Click the **Show Detail** or **Show Outline** button at the lower right of the **Production Information** dialog box.

The view will change between the production information details and outline.

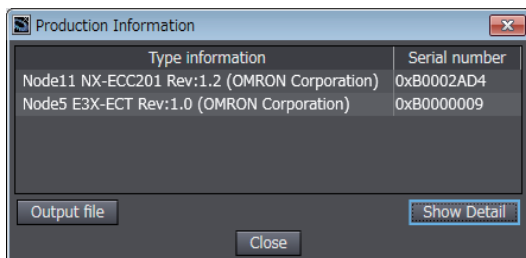

Outline View

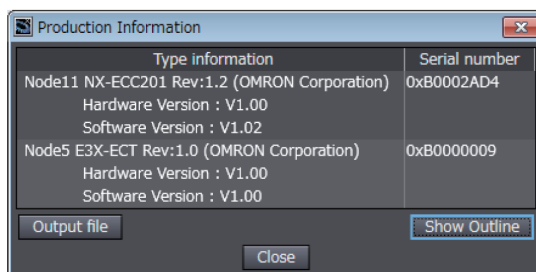

Detail View

Related Manuals

The following manuals are related. Use these manuals for reference.

Manual name	Cat. No.	Model numbers	Application	Description
NJ-Series CPU Unit Hardware User's Manual	W500	NJ501-□□□□ NJ301-□□□□ NJ101-□□□□	Learning the basic specifications of the NJ-series CPU Units, including introductory information, designing, installation, and maintenance. Mainly hardware information is provided.	Provides an introduction to the entire NJ-series system along with the following information on the CPU Unit. <ul style="list-style-type: none"> • Features and system configuration • Introduction • Part names and functions • General specifications • Installation and wiring • Maintenance and inspection
NJ/NX-series CPU Unit Software User's Manual	W501	NX701-□□□□ NX102-□□□□ NX1P2-□□□□ NJ501-□□□□ NJ301-□□□□ NJ101-□□□□	Learning how to program and set up an NJ/NX-series CPU Unit. Mainly software information is provided.	Provides the following information on a Controller built with an NJ/NX-series CPU Unit. <ul style="list-style-type: none"> • CPU Unit operation • CPU Unit features • Initial settings • Language specifications and programming based on IEC 61131-3
NJ/NX-series Instructions Reference Manual	W502	NX701-□□□□ NX102-□□□□ NX1P2-□□□□ NJ501-□□□□ NJ301-□□□□ NJ101-□□□□	Learning detailed specifications on the basic instructions of an NJ/NX-series CPU Unit.	Describes the instructions in the instruction set (IEC 61131-3 specifications).
NJ/NX-series CPU Unit Motion Control User's Manual	W507	NX701-□□□□ NX102-□□□□ NX1P2-□□□□ NJ501-□□□□ NJ301-□□□□ NJ101-□□□□	Learning about motion control settings and programming concepts.	Describes the settings and operation of the CPU Unit and programming concepts for motion control.
NJ/NX-series Motion Control Instructions Reference Manual	W508	NX701-□□□□ NX102-□□□□ NX1P2-□□□□ NJ501-□□□□ NJ301-□□□□ NJ101-□□□□	Learning about the detailed motion instruction specifications	Describes the motion control instructions.
NJ/NX-Series CPU Unit Built-in EtherCAT® Port User's Manual	W505	NX701-□□□□ NX102-□□□□ NX1P2-□□□□ NJ501-□□□□ NJ301-□□□□ NJ101-□□□□	Using the built-in EtherCAT port on an NJ/NX-series CPU Unit.	Provides information on the built-in EtherCAT port. This manual provides an introduction and information on the configuration, features, and setup.
NJ/NX-series CPU Unit Built-in EtherNet/IP™ Port User's Manual	W506	NX701-□□□□ NX102-□□□□ NX1P2-□□□□ NJ501-□□□□ NJ301-□□□□ NJ101-□□□□	Using the built-in EtherNet/IP port on an NJ/NX-series CPU Unit.	Describes information on the built-in EtherNet/IP port. Provides information on the basic setup, tag data links, and other features.
NJ/NX-series Database Connection CPU Unit User's Manual	W527	NX701-□□20 NJ501-□□20 NJ101-□□20	Using the database connection service in the NJ/NX-series	Describes the database connection service.
NJ/NX-series Troubleshooting Manual	W503	NX701-□□□□ NX102-□□□□ NX1P2-□□□□ NJ501-□□□□ NJ301-□□□□ NJ101-□□□□	Learning about the errors that may be detected in an NJ/NX-series Controller.	Describes concept on managing errors that may be detected in an NJ/NX-series Controller and information on individual errors.
Sysmac Studio Version 1 Operation Manual	W504	SYSMAC -SE2□□□	Learning about the operating procedures and functions of the Sysmac Studio.	Describes the operating procedures of the Sysmac Studio.

Manual name	Cat. No.	Model numbers	Application	Description
NX-Series EtherCAT® Coupler Unit User's Manual	W519	NX-ECC□□□	Learning how to use the NX-series EtherCAT Coupler Unit and EtherCAT slave terminals	Describes system configuration and method to build an EtherCAT slave terminal which consists of NX-series EtherCAT Coupler Unit and NX Units, and information on hardware, functions, and how to setup, control and monitor the NX Units via the EtherCAT communications.
NY-series IPC Machine Controller Industrial Panel PC Hardware User's Manual	W557	NY532-1□□□	Learning the basic specifications of the NY-series Industrial Panel PCs, including introductory information, designing, installation, and maintenance. Mainly hardware information is provided.	An introduction to the entire NY-series system is provided along with the following information on the Industrial Panel PC. <ul style="list-style-type: none"> • Features and system configuration • Introduction • Part names and functions • General specifications • Installation and wiring • Maintenance and inspection
NY-series IPC Machine Controller Industrial Box PC Hardware User's Manual	W556	NY512-1□□□	Learning the basic specifications of the NY-series Industrial Box PCs, including introductory information, designing, installation, and maintenance. Mainly hardware information is provided.	An introduction to the entire NY-series system is provided along with the following information on the Industrial Box PC. <ul style="list-style-type: none"> • Features and system configuration • Introduction • Part names and functions • General specifications • Installation and wiring • Maintenance and inspection
NY-series IPC Machine Controller Industrial Panel PC/Industrial Box PC Setup User's Manual	W568	NY532-1□□□ NY512-1□□□	Learning the initial settings of the NY-series Industrial PCs and preparations to use Controllers.	The following information is provided on an introduction to the entire NY-series system. <ul style="list-style-type: none"> • Two OS systems • Initial settings • Industrial PC Support Utility • NYComplet • Industrial PC API • Backup and recovery
NY-series IPC Machine Controller Industrial Panel PC/Industrial Box PC Software User's Manual	W558	NY532-1□□□ NY512-1□□□	Learning how to program and set up the Controller functions in an NY-series Industrial PC.	The following information is provided on the NY-series Controller functions. <ul style="list-style-type: none"> • Controller operation • Controller features • Controller settings • Programming based on IEC 61131-3 language specifications
NY-series Instructions Reference Manual	W560	NY532-1□□□ NY512-1□□□	Learning detailed specifications on the basic instructions of an NY-series Industrial PC.	The instructions in the instruction set (IEC61131-3 specifications) are described.
NY-series IPC Machine Controller Industrial Panel PC/Industrial Box PC Motion Control User's Manual	W559	NY532-1□□□ NY512-1□□□	Learning about motion control settings and programming concepts of an NY-series Industrial PC.	The settings and operation of the Controller and programming concepts for motion control are described.
NY-series Motion Control Instructions Reference Manual	W561	NY532-1□□□ NY512-1□□□	Learning about the specifications of the motion control instructions of an NYseries Industrial PC.	The motion control instructions are described.

Manual name	Cat. No.	Model numbers	Application	Description
NY-series IPC Machine Controller Industrial Panel PC/Industrial Box PC Built-in EtherCAT® Port User's Manual	W562	NY532-1□□□ NY512-1□□□	Using the built-in EtherCAT port in an NY-series Industrial PC.	Information on the built-in EtherCAT port is provided. This manual provides an introduction and provides information on the configuration, features, and setup.
NY-series IPC Machine Controller Industrial Panel PC/Industrial Box PC Built-in EtherNet/IP™ Port User's Manual	W563	NY532-1□□□ NY512-1□□□	Using the built-in EtherNet/IP port in an NY-series Industrial PC.	Information on the built-in EtherNet/IP port is provided. Information is provided on the basic setup, tag data links, and other features.
NY-Series Troubleshooting Manual	W564	NY532-1□□□ NY512-1□□□	Learning about the errors that may be detected in an NY-series Industrial PC.	Concepts on managing errors that may be detected in an NY-series Controller and information on individual errors are described.
NJ/NY-series NC Integrated Controller User's Manual	O030	NJ501-5300 NY532-5400	Learnig how to use the numerical control with NJ/NY series.	The manual describes how to setup/use the NC functions. Please read it with Instruction Reference Manual G code (O031) when programming.
NJ/NY-series G code Instruction Reference Manual	O031	NJ501-5300 NY532-5400	Learning the detailed specification of G Code / M Code.	The manual describes how to use G code / M code. Please read it with User's manual (O030) when programming.
CNC Operator Operation Manual (this manual)	O032	SYS-MAC-RTNC0□□□□D	Learning how to use CNC Operator.	The manual describes CNC Operator procedures for NC Integrated Controller. (Install, functions, connectivity, and so on)
Sysmac Studio Project Version Control Function Operation Manual	W589	SYSMAC-SE2□□□□ SYSMAC-TA4□□□□	Learning the overview of the Sysmac Studio project version control function and how to use it.	The manual outlines the Sysmac Studio project version control function, and describes how to install, basic operation, and how to operate its major functions.

Revision History

A manual revision code appears as a suffix to the catalog number on the front and back covers of the manual.

Cat. No.	O032-E1-03
-----------------	-------------------

↑
Revision code

Revision code	Date	Revised content
01	October 2017	Original production
02	July 2018	<ul style="list-style-type: none">• Added information on the NX102-□□□□.• Corrected mistakes.
03	June 2022	Corrected mistakes.

1

CNC Operator Overview

This section describes the product outline and features of CNC Operator.

1-1 What is CNC Operator? 1-2

1-1 What is CNC Operator?

CNC Operator is a CNC console application that operates and monitors the CNC Controller.

You can use CNC Operator together with an NJ/NY-series CNC Controller and the Sysmac Studio Automation Software to realize optimum functionality and ease of operation. Features that are frequently used in CNC machines are provided on the standard screen, which enables you to connect and use the CNC Controller without configuring special settings.

Also, CNC Operator monitors CNC Controller operations working with the programming tool, Sysmac Studio.

Main Features

● Implemented standard screen

The basic features used for the CNC machine console are provided on the standard screen.

- NC Program Editor
- CNC Coordinate System Variable Monitor
- Various types of basic CNC console functions (Cycle Start, Dry Run, MDI, jog operation, troubleshooting, etc.)

● Simulation

The simulation function of the Sysmac Studio enables you to debug programs in an environment in which there is no CNC machine.

● Customization by the Software Development Kit

If you use the optional CNC Operator Software Development Kit (SYSMAC-RTNC0101D), desired controls can be created and added to the standard screen features.

2

Basic Operations of CNC Operator

This section describes the operation flow, software configuration, and screen configuration of CNC Operator.

2-1	Installation	2-2
2-1-1	System requirement	2-2
2-1-2	Installation Procedure	2-2
2-1-3	Uninstallation Procedure	2-3
2-2	System Design	2-4
2-2-1	Basic Design Flow	2-4
2-2-2	Outline of System Design	2-5

2-1 Installation

2-1-1 System requirement

The hardware to install the software must satisfy the following requirements.

OS	Microsoft Windows 7 (SP1 or later)/8/8.1/10 32-bit/64-bit
CPU	IBM AT or compatible with Intel® Celeron® 540 (1.8 GHz) or higher processor
Memory	2GB or more
Display	WXGA 1280 × 800 16.77 million colors or more
HDD*1	.NET Framework 4.6 is installed: With 50MB or more free space .NET Framework 4.6 is not installed: With 5GB or more free space
Auxiliary storage device	At least one DVD-ROM drive

*1. Motion Commander Foundation from Greene & Morehead Engineering is installed as a common framework.

2-1-2 Installation Procedure

- 1** If the USB dongle is attached to your computer, disconnect it.
- 2** Start Windows, and insert the installation disk into the DVD-ROM drive. If you use the installer (Web version installer) obtained from the Omron website, start the installation execution file from where the Web version installer is stored.
The setup program starts automatically and the Select Setup Language dialog box is displayed.



Additional Information

If .NET Framework is not installed on the computer, the .NET Framework Installation dialog box is displayed. Follow the instructions to install it.

When .NET Framework is installed, a confirmation dialog box to restart the computer is displayed. Always click the **Yes** button to restart the computer. After the computer is restarted, the Setup Wizard will automatically continue to the next step.

- 3** Follow the instructions shown on the screen to install the software.

2-1-3 Uninstallation Procedure

- 1** If the USB dongle is attached to your computer, disconnect it.
- 2** Open Windows Control Panel ^{*1}, and select Add or Remove Programs.
- 3** Select **CNC Operator**, and run uninstallation.

*1. The procedure for opening Control Panel differs depending on the operating system.

Windows 7: Select Control Panel from the Start menu.

Windows 8/8.1: Press the **Windows** key and **X** key at the same time. From the menu that appears, select **Control Panel**.

Windows10: Right-click the **Start** button and select **Control Panel**.

2-2 System Design

To use CNC Operator, the system, including the entire system configuration, connections, and settings, must be correctly designed.

This section describes general system design.

2-2-1 Basic Design Flow

The following shows the basic design flow.

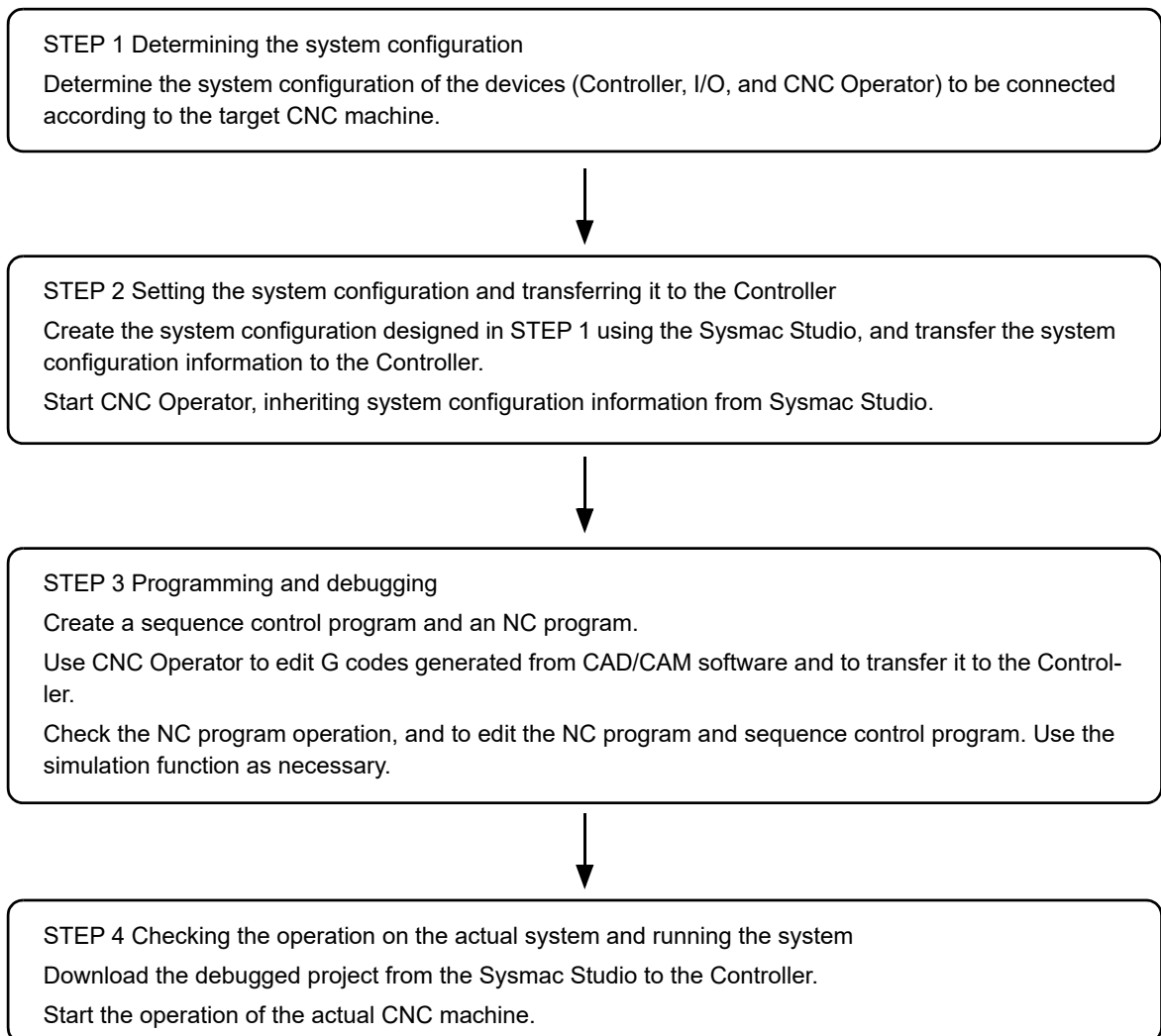

2-2-2 Outline of System Design

This section describes an outline of steps provided in 2-2-1 *Basic Design Flow* on page 2-4.

● STEP 1 Determining the system configuration

Determine the system configuration of the devices to be connected according to the target CNC machine. On CNC Operator, determine the screen specifications to be applied to the CNC machine.

Subsequent steps are the setup procedure to use the standard screen provided by CNC Operator.

For procedure for constructing the system when the screen specifications are changed, refer to the help manual for CNC Operator Software Development Kit (SYSMAC-RTNC0101D).

● STEP 2 Setting the system configuration and transferring it to the Controller

Use Sysmac Studio to configure a project for operating CNC Operator.

STEP 2-1 Construct a sequence control program to configure an initial project.

Step	Description	Reference
Creating a base project	Import the sequence control program sample included in the package, and create a base project.*1	<i>NC Integrated Controller Sample Program Manual</i>

*1. The sequential control program sample is required for CNC Operator to configure CNC Controller parameters, monitor, and issue operating instructions. This program supports all features that CNC Operator handles, and is able to use them without editing.

STEP 2-2 Configure various settings.

Step	Description	Reference
Setting the CNC coordinate system	Configure the following settings on the base project: <ul style="list-style-type: none"> • CNC coordinate system settings • CNC motor settings • CNC coordinate system parameter settings • Spindle motor settings (when required) 	<i>Sysmac Studio Version 1 Operation Manual</i> (Cat. No. W504)
Setting FTP	Configure the settings required to communicate with CNC Operator.	<ul style="list-style-type: none"> • <i>Sysmac Studio Version 1 Operation Manual</i> (Cat. No. W504) • <i>Setting the IP Address</i> on page 3-8
Other settings	Configure the settings other than the CNC Coordinate System items required to operate the machine. <ul style="list-style-type: none"> • Network Settings • Motion axis settings • Servo Drive settings and adjustment 	<i>Sysmac Studio Version 1 Operation Manual</i> (Cat. No. W504)
Transferring the settings	Transfer the above settings to the Controller.	<i>Sysmac Studio Version 1 Operation Manual</i> (Cat. No. W504)

● STEP 3 Programming and debugging

STEP 3-1 Use the Sysmac Studio to create a program.

Step	Description	Reference
Creating an NC program and a sequence control program	Add an NC program on the base project. <ul style="list-style-type: none"> • Adding a sequence control program • Programming by the G Code Editor 	<ul style="list-style-type: none"> • <i>NJ/NY-Series NC Integrated Controller User's Manual</i> (Cat. No. O030) • <i>NJ/NY-series G code Instruction Reference Manual</i> (Cat. No. O031)
Program check/build	Check and build the NC program.	<i>Sysmac Studio Version 1 Operation Manual</i> (Cat. No. W504)

STEP 3-2 Use the Sysmac Studio to transfer the program to the Controller.

Step	Description	Reference
Transferring the program	Transfer the built program to the Controller.	<i>Sysmac Studio Version 1 Operation Manual</i> (Cat. No. W504)

STEP 3-3 Start CNC Operator, and check the settings.

Step	Description	Reference
Starting CNC Operator	Start CNC Operator. There are two ways to start Sysmac CNC Operator. <ol style="list-style-type: none"> 1. Normal startup If the settings described in STEP 2 are already completed, use this normal startup. 2. Startup by inheriting the CNC setting information from the Sysmac Studio Use this method to start CNC Operator for the first time after installing it. 	3-11 <i>Starting from the Sysmac Studio</i> on page 3-56
Confirming settings	Open the Machine View and check the CNC Operator operation settings.	3-3 <i>Features and Settings of CNC Operator</i> on page 3-8

STEP 3-4 Use CNC Operator to create and transfer a program.

Step	Description	Reference
Creating and importing an NC program	Use CAD/CAM software to create a machining program (G code). Import (copy) the program to the G Code Editor of CNC Operator.	Manual for each CAD/CAM software 3-6 <i>NC Programs</i> on page 3-32
Transferring the NC program ^{*1}	To download the NC program via communication, use the Editor View. When using an SD Card, copy the program to the SD Card and transfer it to the Controller.	3-6 <i>NC Programs</i> on page 3-32

*1. Setting SYSMAC Gateway is required for communications between CNC Operator and the Controller. Refer to A-2 *Setting SYSMAC Gateway, Communications Middleware* on page A-3 for details.

STEP 3-5 Debug the program.

Two methods are available to debug the NC program: One uses the Sysmac Studio Simulator, and the other connects Sysmac CNC Operator directly to the actual system.

Step	Description	Reference
Debugging on the Simulator	Start the Sysmac Studio, then the Simulator. Set the connection destination of CNC Operator to Simulator.	<i>Sysmac Studio Version 1 Operation Manual</i> (Cat. No. W504)
Debugging by connecting the actual system	Set the connection destination of CNC Operator to the Controller.	<i>3-3-1 CNC Controller Connection Settings</i> on page 3-8

Then, use the CNC Operator function to debug the program.

Step	Description	Reference
Executing a test run	Perform dry run. <ul style="list-style-type: none"> • Block execution • Dry run • Machine lock • Auxiliary function lock • Velocity override • Spindle operation, stop, and orientation 	<i>3-8 Test Run</i> on page 3-47
Manual adjustment	Perform fine adjustment with a manual pulse generator. Execute a part of the program with MDI.	<i>3-7 MDI (Manual Data Input)</i> on page 3-37 <i>3-7-4 Manual Mode</i> on page 3-45

● STEP 4 Checking the operation on the actual system and running the system

After configuring the settings and completing programming and debugging, run the actual operation of the device.

Step	Description	Reference
Starting the operation	Execute Cycle Start.	<i>3-9 Field Operation</i> on page 3-49
Checking for warnings and errors	Check the warnings and errors on the Event Viewer and reset them.	<i>3-10 Troubleshooting</i> on page 3-54

3

Features of CNC Operator

This section describes the features of CNC Operator.

3-1	Starting and Exiting CNC Operator	3-3
3-2	User Interface	3-4
3-3	Features and Settings of CNC Operator	3-8
3-3-1	CNC Controller Connection Settings	3-8
3-3-2	Axis Settings	3-10
3-3-3	Tool Status	3-12
3-3-4	NC Program Status	3-12
3-3-5	G Codes (Modal Group)	3-13
3-3-6	Display and Pin Display of Setting Items	3-14
3-3-7	General Application Settings	3-15
3-3-8	Message Log	3-25
3-3-9	Memo Function	3-25
3-3-10	Common Functions	3-25
3-4	Function Execution Conditions and Operating Modes	3-26
3-5	Tool Offsets/Workpiece Offsets	3-29
3-5-1	Tool Offset Management	3-29
3-5-2	Work Offset Management	3-30
3-6	NC Programs	3-32
3-6-1	AUTO	3-32
3-6-2	Full Screen Editor	3-34
3-6-3	NC Subprograms	3-35
3-6-4	Queue	3-36
3-7	MDI (Manual Data Input)	3-37
3-7-1	Switching Modes	3-37
3-7-2	Vertical button bar	3-39
3-7-3	Soft Control Panel (Velocity Override)	3-43
3-7-4	Manual Mode	3-45
3-8	Test Run	3-47
3-8-1	CNC Motor Compensation	3-47
3-8-2	Correction of NC Program	3-48
3-8-3	Simulation	3-48

3-9 Field Operation	3-49
3-9-1 Connection with CNC Controller	3-49
3-9-2 Display of the Running Program and the Path	3-49
3-9-3 Login User Information	3-50
3-9-4 Functions to Change Screen Display	3-50
3-9-5 Alarms	3-51
3-9-6 Message Status Bar	3-51
3-9-7 Watchdog Indicator	3-51
3-9-8 NC Parameter Window	3-52
3-9-9 Axis Parameter Window	3-53
3-10 Troubleshooting	3-54
3-10-1 Event Viewer	3-54
3-10-2 Back Trace	3-55
3-11 Starting from the Sysmac Studio	3-56

3-1 Starting and Exiting CNC Operator

Starting CNC Operator

- 1 Attach the USB dongle to your computer.
The optional USB dongle (SYSMAC-RTNC0001L) is required to start CNC Operator.
- 2 From the Windows Start menu, select **OMRON** then **CNC Operator** to start.



Precautions for Correct Use

CNC Operator cannot be started in the Windows Remote Desktop environment.

Exiting CNC Operator

Press the Shut down button in the login view.



WARNING

If you disconnect the USB dongle during operation, CNC Operator stops operating. In the controller program, configure a control circuit to safely stop the system even if CNC Operator stops operating. For example, it should execute heartbeat processing between CNC Operator and the controller, and stop the system when the heartbeat is lost. Accidents may occur if the system performs unexpected operations. For the detailed heartbeat configuration method, refer to *A-3 Heartbeat Configuration Example* on page A-7.



3-2 User Interface

This section describes the screen configuration of CNC Operator.

CNC Operator has the following views.

Screen	Description
Login View	This View appears first when CNC Operator starts.
Machine View	Use this View to configure the CNC Operator settings.
Main View	Use this View to operate CNC.
Editor	Use this Editor to edit NC programs.
Event Viewer	Displays controller events.

Login View

Use this View to start or exit CNC Operator, and switch between login users.

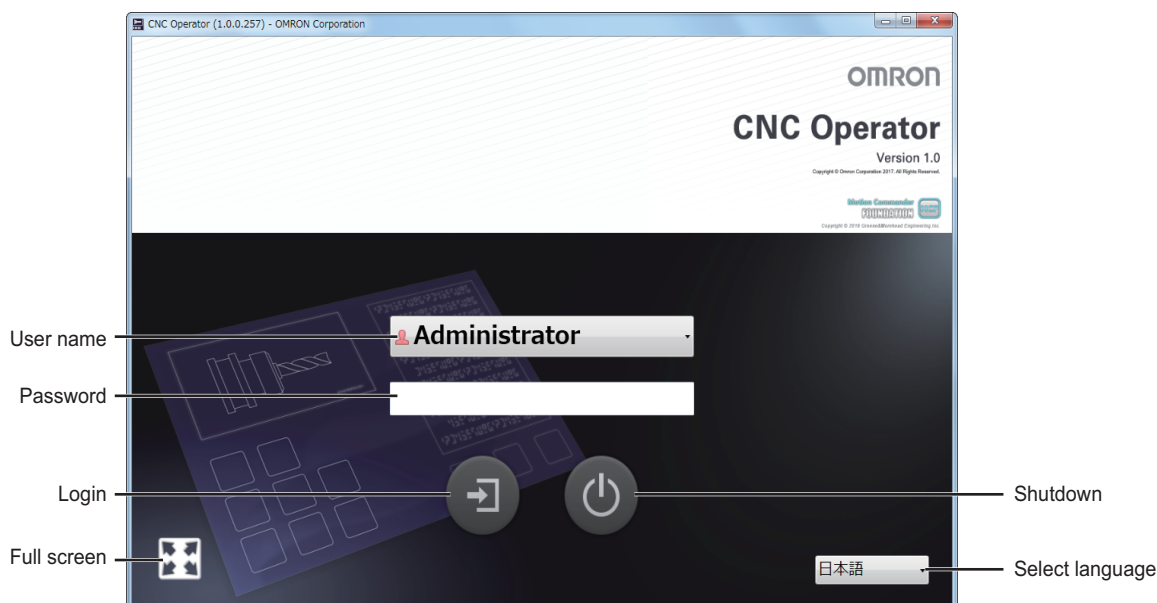

Item	Description
User name	Select a login user. For more information on user registration, refer to <i>User Information Settings</i> on page 3-18.
Password	Enter the password. If the password is not specified, the user cannot enter the password to log in.
Login	Click this to log in to CNC Operator.
Shut down	Click this to shutdown CNC Operator.
Full screen	Click this to switch the view to full screen mode.
Select language	Select a language for the user with Administrator rights. The language setting immediately applies to the user information. Refer to <i>User Information Settings</i> on page 3-18 for user information.

Machine View

Displays data shared between CNC Operator and the Controller. Features of this View also include those used to record data, control applications, change settings, and view the message log.

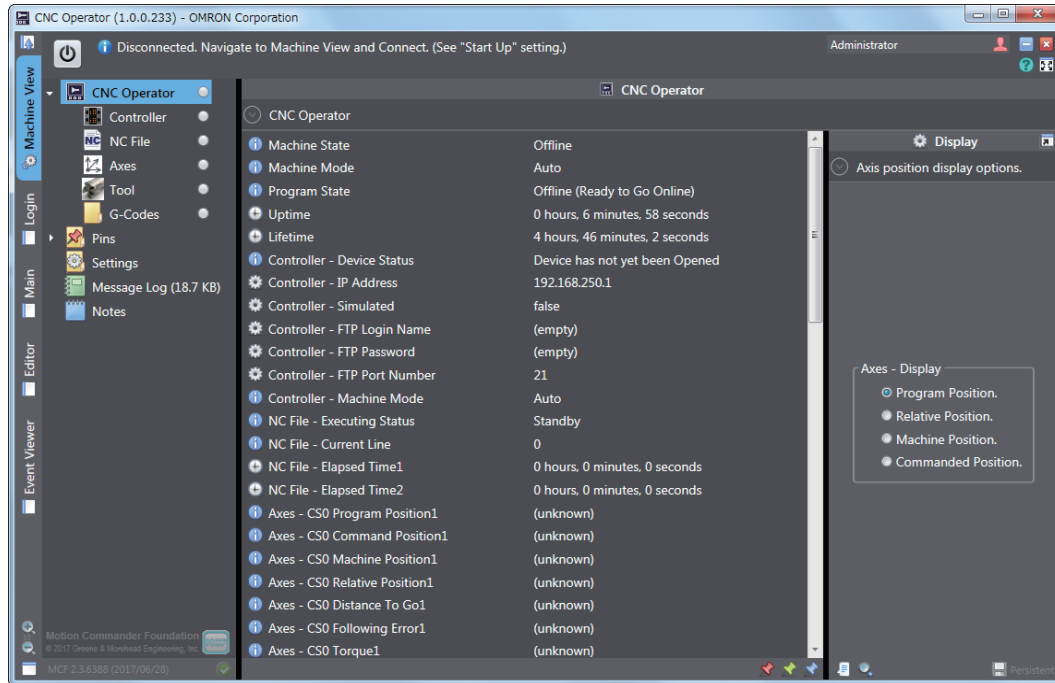

The following table lists available features.

Item	Description
Controller	Configures and monitors the Controller currently connected.
NC File	Displays the NC program file status.
Axes	Displays the Axes settings.
Tool	Displays the tool status.
G-Codes	Displays G code groups. When you select a G code group, the G code currently running is displayed.
Pins	Configure pin settings.
Settings	Configure the general application settings.
Message Log	Displays the message log.
Notes	The memo function can be used.

Main View

This is the console screen of CNC. This is used to perform basic operations.

The following shows an outline of the View.

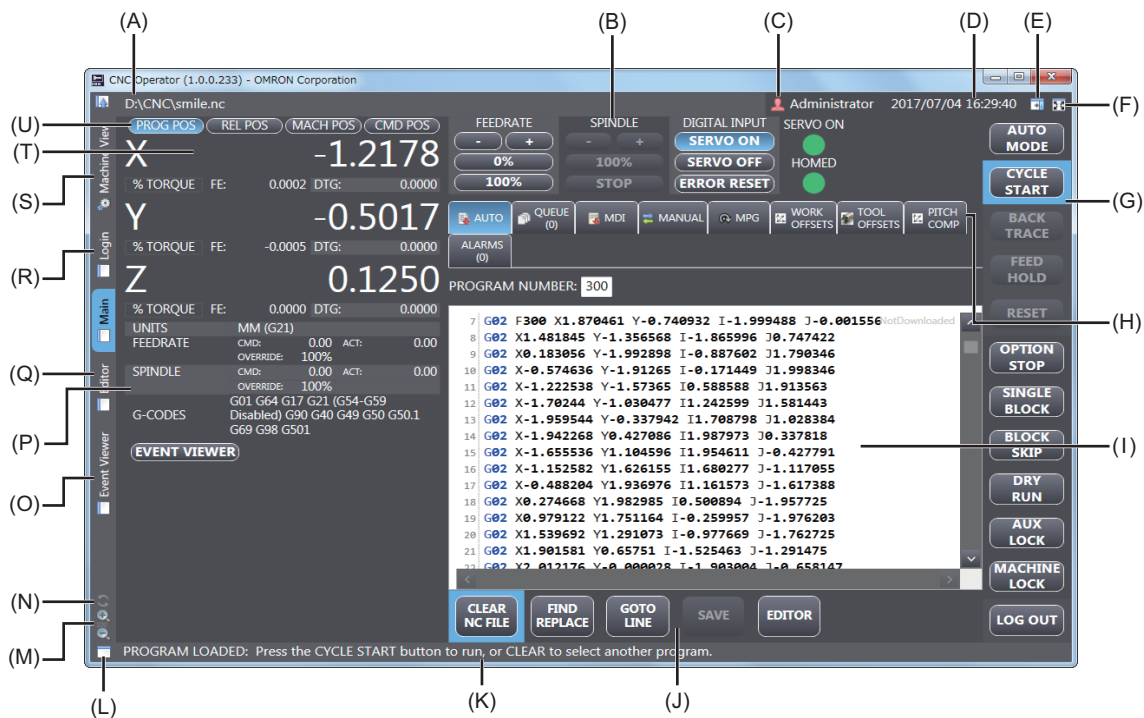

	Description
A	Displays the program currently loaded and its path information.
B	Soft Control Panel. Operate functions (feedrate, spindle, digital input) in online mode, and confirm Servo ON and homing status.
C	Displays the current login user.
D	Displays the current time and running time of the NC program.
E	Switches show/hide modes of the message log.
F	Changes to the full screen display.
G	Vertical bar. Use this for operator's main operations.
H	Tab view. Select each view inside.
I	Displays or edits the running NC program.
J	Horizontal bar. Used to edit the NC program.
K	Status bar. Displays various statuses.
L	Switches the screen between the stand-alone and embedded mode.
M	Enlarges or reduces the displayed target.
N	Displays the connection status in an online mode.
O	Displays controller events.
P	Displays NC parameters.
Q	Displays the NC full-screen editor.
R	Displays the login view.
S	Displays the machine view.
T	Displays CNC motor parameters.
U	Select the default axis display.

Editor

Displays the NC Program Editor in full screen mode. Refer to *3-6-2 Full Screen Editor* on page 3-34 for details.

Event Viewer

Displays controller events. Refer to *3-10 Troubleshooting* on page 3-54 for details.

3-3 Features and Settings of CNC Operator

The Machine View screen enables you to configure the CNC Controller settings. This section describes each setting item.

3-3-1 CNC Controller Connection Settings

Select the Machine View tab, then Controller. On the screen that appears, you can configure the settings related to CNC Controller connections.

The items are described in the following table.

Item	Description
Device Status	Shows the connection status of the Controller.
IP Address	Specifies the IP address of the Controller to be connected.
Simulated	Sets the connection of Sysmac Studio to the Simulator.
FTP Login Name	Specifies the FTP login user name for the CNC Controller.
FTP Password	Specifies the FTP password for the CNC Controller.
FTP Port Number	Specifies the FTP TCP/IP port number for the CNC Controller.
Machine Mode	Shows the current status of the CNC Controller.

Setting the IP Address

In **IP Address**, specify the IP address of the Controller to be connected.

- 1 In the following dialog box, enter the IP address of the Controller to be connected.

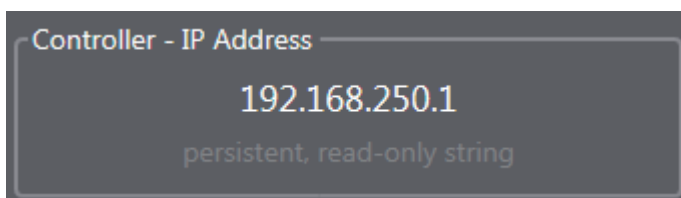

Precautions for Correct Use

Use Ethernet to connect to the CNC Controller.

- 2 Click the **Apply** button.

Simulated

In **Simulated**, set whether to connect to the simulation function of Sysmac Studio.

- 1 Switch the connection destination in the setting shown in the following screenshot. Select True to switch the destination to the Simulator of Sysmac Studio.

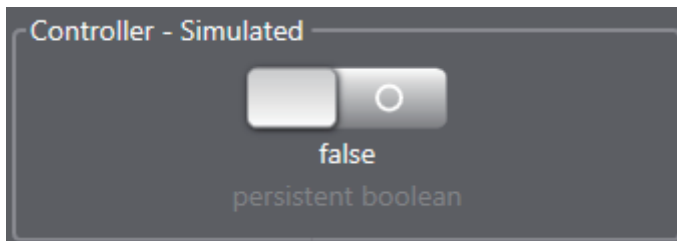

- 2 Start the Sysmac Studio, then the Simulator. Refer to the *Sysmac Studio Version 1 Operation Manual* (Cat. No. W504) for details of Simulator operation.



Additional Information

To establish simulator connection, CNC Operator and Sysmac Studio must be installed in the same PC.

FTP Connection

Sysmac CNC Operator uses an FTP connection to transfer NC programs and correction data to the Controller. To establish an FTP connection, you must set the FTP login user name, FTP password, and FTP port number.

- 1 Enter the FTP login name in the setting shown in the following screenshot.

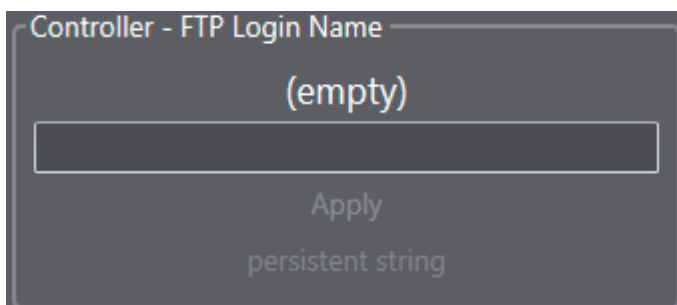

- 2 Click the **Apply** button.
- 3 Take the same steps to set the FTP password and the FTP port number.



Precautions for Correct Use

When the Simulator is connected, the FTP port number is fixed to 21. The FTP does not run with a port number other than 21.

3-3-2 Axis Settings

Select the Machine View tab, then Axes. On the screen that appears, check the CNC motor values and configure the display settings.

The settings are valid when the Controller is connected online.

The following item can be configured or the following status can be checked.

Item	Description
Display	Select the position at which the axis is displayed in the initial status.

The following values can be checked.

Item	Description
CS*1 Program Position n	Program position of the n-th axis
CS*1 Commanded Position n	Commanded position of the n-th axis
CS*1 Machine Position n	Machine position of the n-th axis
CS*1 Relative Position n	Relative position of the n-th axis
CS*1 Distance To Go n	Remaining travel distance of the n-th axis
CS*1 Following Error n	Following Error value of the n-th axis
CS*1 Torque n	Torque value of the n-th axis
CS*1 Cmd Feedrate	Command feedrate of the n-th axis
CS*1 Act Feedrate	Actual feedrate of the n-th axis
CS*1 Homed n	Homed state of the n-th axis
CS*1 Servo On n	SERVO ON state of the n-th axis
CS*1 Servo On Spindle	Spindle axis servo on state
Feedrate Override	Override factor of feedrate

*1. Coordinate system number n: Indicates the axis number (n = 1 to 6).

The number and axis name are combined as follows.

1: X axis, 2: Y axis, 3: Z axis, 4: A axis, 5: B axis, 6: C axis

Display Setting

In Display, select the position at which the axis will be displayed in the initial status.

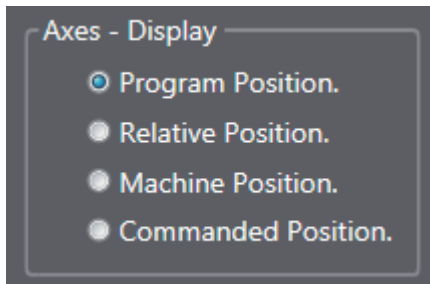

Item	Description
Program Position	Sets the initial status to the Program Position.
Relative Position	Sets the initial status to the Relative Position.
Machine Position	Sets the initial status to the Machine Position.
Commanded Position	Sets the initial status to the Commanded Position.

3-3-3 Tool Status

Select the **Machine View** tab, then **Tool**. On the screen that appears, view the tool status.

The following list shows the statuses that can be confirmed.

Item	Description
CS*1 Cmd Spindle	Commanded speed value of the spindle assigned to the target coordinate system
CS*1 Act Spindle	Resultant speed value of the spindle assigned to the target coordinate system
Spindle Override	Override rate of the spindle assigned to the target coordinate system

*1. Indicates the coordinate system number.

3-3-4 NC Program Status

Select the **Machine View** tab, then **NC File**. On the screen that appears, view the NC program status.

The following list shows the statuses that can be confirmed.

Item	Description
Executing Status	Executing status of the NC program
Current Line	Line of the NC program currently executed
Elapsed time1	Execution time period of the NC program, including feed hold time
Elapsed time2	Execution time period of the NC program, excluding feed hold time

3-3-5 G Codes (Modal Group)

Select the **Machine View** tab, then **G-Codes**. On the screen that appears, view the G code groups to be executed in modal mode.

Example: List of G codes displayed when Motion Group is selected.

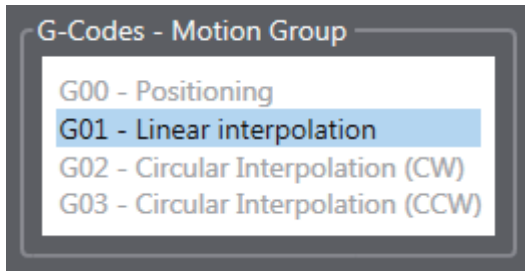

When you select a G code group, G codes currently executed in the group are displayed in the View.

Item	Description
Motion Group	0:G00/1:G01/2:G02/3:G03
Path Control Group	0:G61/1:G64
Plane Group	0:G17/1:G18/2:G19
Unit Group	0:G20/1:G21
Coordinate System Group	(G54 to G59 disabled)
Distance Group	0:G90/1:G91
Tool Radius Group	0:G40/1:G41/2:G42
Tool Length Offset Group	0:G43/1:G44/2:G49
Scaling Group	0:G50/1:G51
Mirroring Group	0:G50.1/1:G51.1
Rotation Group	0:G68/1:G69
Return Level Group	0:G98/1:G99
Multi Block Acceleration Group	0:G500/1:G501

3-3-6 Display and Pin Display of Setting Items

The Machine View provides a pin function that is capable of displaying only necessary items. This enables you to conveniently select and display frequently-used functions or settings.

Selecting Items to be Pinned

- 1** Select an item to be pinned from the tree view of the **Machine View**.
- 2** Press the pin icon at the bottom of the screen.
Select a pin icon from red, green, and blue icons.



Additional Information

The item for which the red pin is selected is displayed at the top of the Controller, G-Codes, Axis, Tool, or NC File screen.

Displaying Pinned Items

- 1** Select **Pins** from the tree view of the **Machine View**.
 - 2** Select the pin color of the pinned items.
- **Releasing pins**
On the screen displayed by selecting the pin color from **Pins**, select an item. Press the pin icon at the bottom of the screen. The pin is released.

3-3-7 General Application Settings

Select the **Machine View** tab, then **Settings**. On the screen that appears, configure the settings related to general features of the application.

The settings are listed in the following table.

Item	Description
Start Up	Behavior at Start-up
Shut Down	Behavior when the application is exited
Update Interval	Update interval of data
Users	User information settings
Always On Top	Always displayed in the foreground
Message Log Size	Log size
Operator Permissions	Showing or hiding the operation screen
Editor Size Limit	Maximum data size of NC program editor
Editor Font Size	Font used for the NC Program Editor
Native Length Units	Length units
Native Length Decimal Places	Setting the number of decimal places
Velocity Time Units	Velocity units
Jog Speed1	Velocity in job setting 1 (Unit: Native length units/min.)
Jog Speed2	Velocity in job setting 2 (Unit: Native length units/min.)
Jog Speed3	Velocity in job setting 3 (Unit: Native length units/min.)
Jog Speed4	Velocity in job setting 4 (Unit: Native length units/min.)
Jog Speed5	Velocity in job setting 5 (Unit: Native length units/min.)
Mpg Distance1	Travel distance at Mpg setting 1 (in CS Unit/100 pulses)
Mpg Distance2	Travel distance at Mpg setting 2 (in CS Unit/100 pulses)
Mpg Distance3	Travel distance at Mpg setting 3 (in CS Unit/100 pulses)
Mpg Distance4	Travel distance at Mpg setting 4 (in CS Unit/100 pulses)
Mpg Distance5	Travel distance at Mpg setting 5 (in CS Unit/100 pulses)
Short Timeout	Timeout time for initialization, reset, and abort
Long Timeout	Timeout time for homing
Machine View Tabs	Changing Machine View display options



Additional Information

The following initial settings are specified in the CNCOperator.ini file. The file is automatically loaded when CNC Operator starts, and is reflected on the settings.

Section	Key	Value	Remarks
Machine Con- structor	UsedAxes	Axis name (e.g., X)	Describe the desired axis name.
	UsedAxesCS* (*: 0 to 7)	Axis name for each CS (e.g., X)	Describe the desired axis name for each CS.
	MotorNumbers	CNC motor number (e.g., 1)	Describe the desired motor numbers by delimiting them with commas (,).
	MotorNumbersCS* (*: 0 to 7)	CNC motor number for each CS (e.g., 1)	Describe the desired CNC motor numbers for each CS by delimiting them with commas (,).
	SpindleMotorNumber	Spindle motor number (e.g., 1)	Describe the desired spindle motor number.
	SpindleMotorNumberCS* (*: 0 to 7)	Spindle motor number for each CS (e.g., 1)	Describe the desired spindle motor number for each CS.
	CoordinateSystem	Number of the coordinate system used for read and write (e.g., 0)	Describe the desired coordinate system number.
	CoordinateSystems	Numbers of the coordinate systems used (e.g., 0,1,2,3)	
	ToolOffsets	Number of tool offsets	Describe the desired number of tool offsets.
Pitch Compensa- tion	CompTableNumbers	Compensation table number (e.g., 1,2)	Describe the desired compensation table information.
	CompTableVariables	Variable name registered for the compensation table (e.g., CNC_Comp_Tab1001)	
NC Files	MainProgramNumber	Number of the first main NC program	–
	MdiProgramNumber	Default NC program number used for MDI	–
	SubprogramFolder	Default folder name on the PC that stores subprograms	–
	VolatileSubprogramMin	The minimum value of the subprogram numbers to be transferred via CNC Operator	–
	VolatileSubprogramMax	The maximum value of the subprogram numbers to be transferred via CNC Operator	–
	NonVolatileProgramIds	Number of the sub program transferred to the controller by Sysmac Studio (Example: 1000, 1001)	–
Parser Options	CustomMCodes	Available M codes (e.g., 2,3,4)	Describe the M code number used in the NC program. If omitted, an error occurs in the sub program calling part when the main program is parsed.

Behavior at Start-up

In **Start Up**, specify a behavior to be performed when the application starts. The selected behavior is enabled from the time of the next start-up.

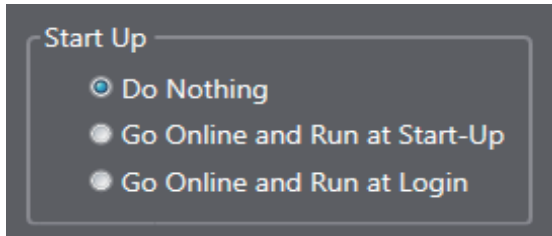

Item	Description
Do Nothing	Only starts the application.
Go Online and Run at Start-Up	After start-up, the application is connected to the CNC Controller online, and the login view is displayed.
Go Online and Run at Login	At login, the application is connected to the CNC Controller online.

Behavior When the Application Is Exited

In **Shut Down**, specify the shutdown operation mode of the application. This setting is applied the next time the application is started.

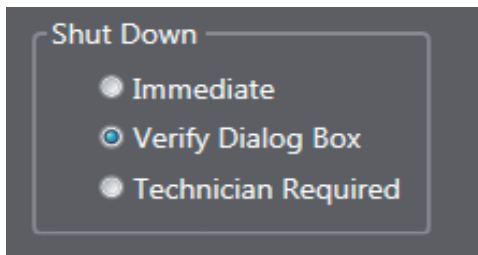

Item	Description
Immediate	Exits the application immediately without displaying the confirmation dialog.
Verify Dialog Box	Displays the confirmation dialog. Select Yes to exit the application, or No to cancel the shutdown procedure.
Technician Required	Prohibits shutdown of the application by a user with Operator rights. Rights higher than the Technician or Administrator rights are required to exit the application. If you have Operator rights and try to exit the application, a warning message appears and you cannot exit the application.

Update Interval of Data

In **Update Interval**, specify the update interval of data (in msec) for the machine.

The available setting range is 50 to 2000. The default value is 500.

User Information Settings

In **Users**, specify the login user name and access rights.

List of users for the login system. (Administrator access only)				
Name	Language	Level	Password	Hint
Administrator	English	Administrator		No password.
Operator	Japanese	Operator		

Item	Description
Name	Login user name
Language	Language settings. The display language can be switched depending on the user.
Level	Access level. Operator , Technician , or Administrator can be selected.
Password	Password. Enter it to log in. Note that the text entered as the password is not masked.
Hint	Hint for the password. Displayed when an incorrect password is entered on the login screen.



Additional Information

- Language settings configured in the start page are reflected on the above user information.
- The changed language setting is not updated while the user is logged in. The setting is updated when the user logs in again after the user was logged out from the main view.
- To delete a registered user, locate the cursor to the target user, and press the delete key.

Setting of Display in Foreground

In **Always On Top**, specify whether to always display the application in the foreground. Press the button to enable or disable this function.

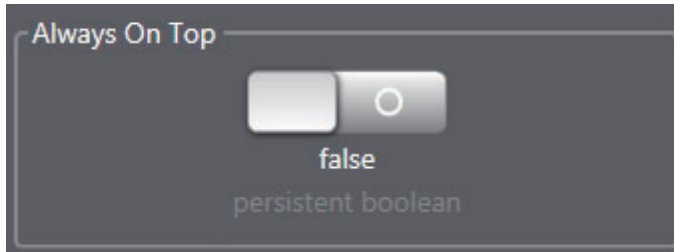

Message Log Size Setting

In **Message Log Size**, specify the maximum size of the message log file (In KB). Enter the maximum size in the setting shown in the following screenshot.

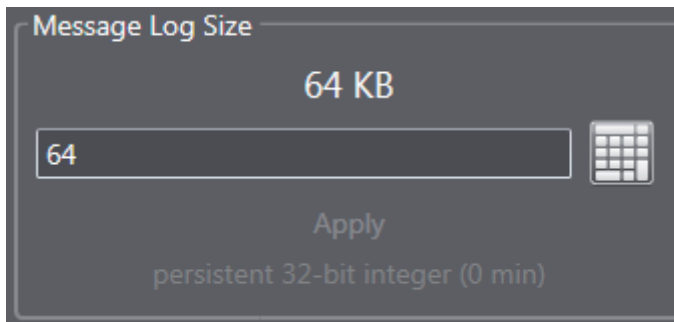

Tab Display Settings

In Machine View Tabs, change the tab display mode.

Item	Description
Fat Tabs	Displays tabs thicker.
Horizontal Tabs	Display tabs horizontally.
Always Visible	Displays tabs when a user other than Administrator logs in.

Operation Screen Display Settings

In Operator Permissions, select functions that users having the Operator rights are allowed to operate.

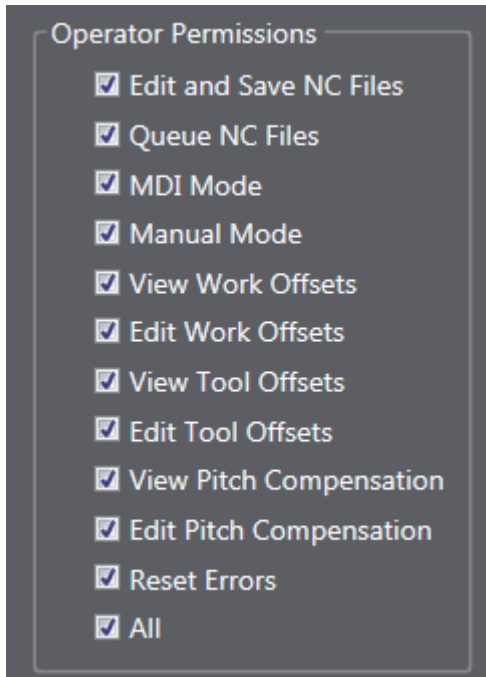

Item	Description
Edit and Save NC Files	Editing and saving NC program files
Queue NC Files	Queuing NC program files
MDI Mode	Switching to MDI mode
Manual Mode	Switching to manual mode
View Work Offsets	Viewing work offsets
Edit Work Offsets	Editing work offsets
View Tool Offsets	Viewing tool offsets
Edit Tool Offsets	Editing tool offsets
View Pitch Compensation	Viewing the CNC compensation table
Edit Pitch Compensation	Editing the CNC compensation table
Reset Errors	Executing error reset
All	All the above functions are made available.

Setting for NC Program Size

In **Editor Size Limit**, specify the maximum size of NC program files that can be loaded to the editor (In MB).

Enter the maximum size in the setting shown in the following screenshot. The minimum value is 1MB, and the maximum is 45MB.

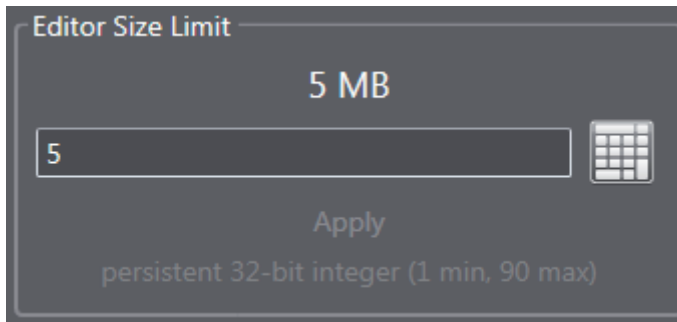

Additional Information

- For the program size available for the controller, refer to the *NJ/NY-Series NC Integrated Controller User's Manual* (Cat. No. O030).
- After the NC program was parsed, the actually transferred file size is displayed at the top of the PARSE window of the full-screen editor. Transfer the file based on the displayed file size.

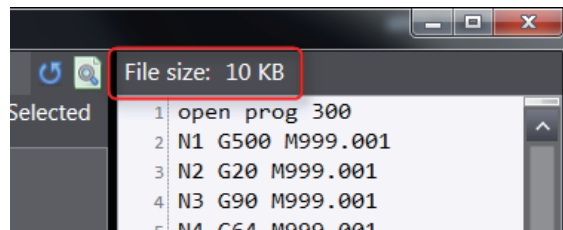

Unit Setting

In **Native Length Units**, specify the unit of length to be displayed. Select the unit in the setting shown in the following screenshot.

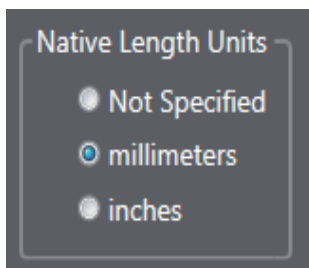

Setting the Number of Decimal Places

In **Native Length Decimal Places**, specify the number of decimal places to be displayed. Enter a number in the setting shown in the following screenshot. A number between 0 and 6 can be set.

Setting the Velocity Unit

In **Velocity Time Units**, specify the unit of velocity to be displayed. Enter the unit in the setting shown in the following screenshot.

Jog Velocity Settings

In **Jog Speed1** to **Jog Speed5**, specify the velocities to be assigned to Jog X1 to X5.

E.g., Setting displayed when **Jog Speed1** is selected.

MPG Distance Setting

In Mpg Distance, set the travel distance (in Unit/100 pulse) when MPG is used. Enter the value in the following text box to set the distance.

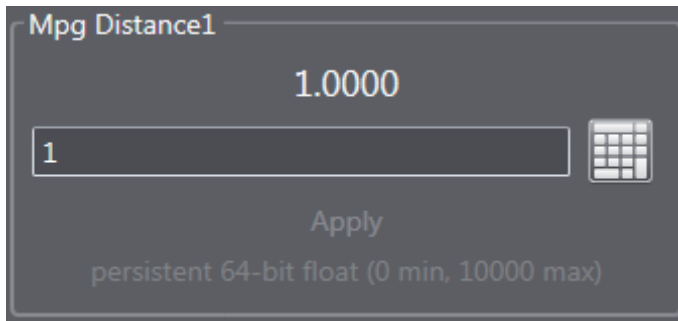

Mpg Distance1

1.0000

1

Apply

persistent 64-bit float (0 min, 10000 max)

Short Timeout Setting

In Short Timeout, set the timeout for the following functions. It is set to 5 by default (In seconds).

- Changing operating modes
- Reset
- Error reset
- All the functions placed on the vertical button bar (e.g., Cycle Start)

Enter the time in the setting shown in the following screenshot.

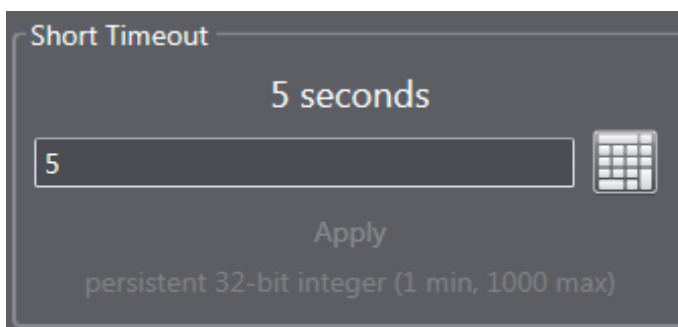

Short Timeout

5 seconds

5

Apply

persistent 32-bit integer (1 min, 1000 max)

Long Timeout Setting

In **Long Timeout**, set the timeout for the following functions that take time for processing. It is set to 60 by default (In seconds).

- Initializing the Controller
- Incremental jog
- Downloading CNC motor compensation table
- Downloading tool offset
- Downloading work offset
- Orientation of spindle axis

Enter the time in the setting shown in the following screenshot.

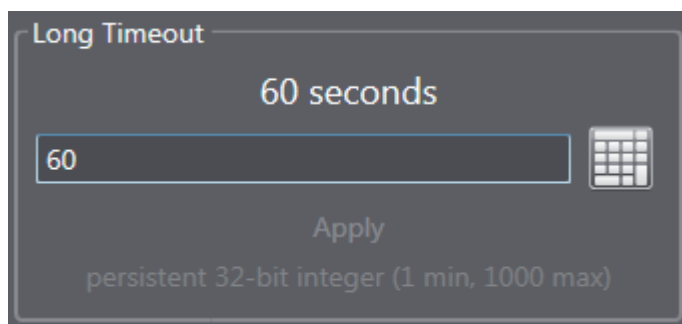

3-3-8 Message Log

Message Log displays login information and history such as changed settings.

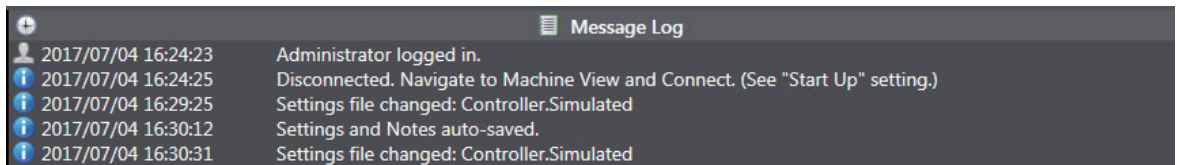

The denotations of the icons are shown in the following table.

Icon	Description
	Time stamp display is enabled
	Time stamp display is disabled

3-3-9 Memo Function

Notes is a memo function. A text editor starts when **Notes** is selected. The text you enter will be saved automatically. Tabs can be added and deleted.

The data is saved in rich text format (rtf) and stored in the installation folder of CNC Operator.

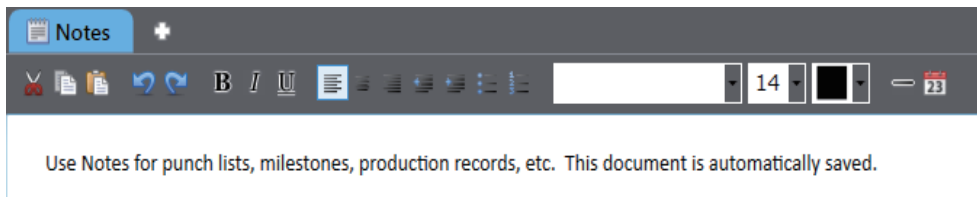

3-3-10 Common Functions

In the **Machine View**, common functions that record operation logs and display the history of program applications are provided.

The following table shows the list of common functions.

Icon	Name	Description
	Log Values	Press this icon to enable or disable the operation log.
	Value History	Press this icon to display the history of application of programs. With the Timestamp button, you can exchange the display order. (Example: 2016-05-16-15:10.10)

3-4 Function Execution Conditions and Operating Modes

This section describes executable statuses (enable and disable) of various functions, and operating modes of CNC Operator.

Function Execution Conditions

Statuses (enable and disable) of various functions depends on the online status of CNC Operator and executing status of the NC program.

● When CNC Operator is offline

		Condition			
		While NC program stops		While NC program is executed	
		Home unde- fined	Home defined	Feed hold OFF	Feed hold ON
Vertical button bar	Operating mode (AUTO, MDI, MAN- UAL)	No			
	CYCLE START	No			
	FEED HOLD	No			
	RESET	No			
	SINGLE BLOCK	No			
	BLOCK SKIP	No			
	OPTION STOP	No			
	DRY RUN	No			
	MACHINE LOCK	No			
	AUX LOCK	No			
LOG OUT	Yes				
Soft control panel	FEEDRATE	No			
	SPINDLE	No			
	DIGITAL INPUT	No			
AUTO	LOAD NC FILE	Yes			
	FIND REPLACE	Yes			
	GOTO LINE	Yes			
	SAVE	Yes			
	EDITOR	Yes			
Queue	Various operations	Yes			
MDI	Edit operation	No			
Manual	JOG	No			
	JOG INCREMEN- TAL	No			
	HOME	No			
	SPINDLE MOVE	No			
Editor	DOWNLOAD	No			

Yes: Enabled, No: Disabled

● When CNC Operator is online

		Condition			
		While NC program stops		While NC program is executed	
		Home unde- fined	Home defined	Feed hold OFF	Feed hold ON
Vertical button bar	Operating mode (AUTO, MDI, MAN- UAL)	Yes	Yes	No	No
	CYCLE START	Yes	Yes	No	Yes
	FEED HOLD	No	No	Yes	Flashing
	RESET	No	No	Yes	Yes
	SINGLE BLOCK	Yes	Yes	No	No
	BLOCK SKIP	Yes	Yes	No	No
	OPTION STOP	Yes	Yes	Yes	Yes
	DRY RUN	Yes	Yes	No	No
	MACHINE LOCK	Yes	Yes	No	No
	AUX LOCK	Yes	Yes	No	No
LOG OUT	No	No	No	Yes	
Soft control panel	FEEDRATE	Yes	Yes	Yes	Yes
	SPINDLE	Yes	Yes	Yes	Yes
	DIGITAL INPUT	Yes	Yes	Yes	Yes
AUTO	LOAD NC FILE	Yes	Yes	Yes	Yes
	FIND REPLACE	Yes	Yes	No	No
	GOTO LINE	Yes	Yes	No	Yes (Search only)
	SAVE	Yes	Yes	Yes	Yes
	EDITOR	Yes	Yes	No	No
Queue	Various operations	Yes	Yes	No	No
MDI	Edit operation	Yes	Yes	Yes	Yes
Manual	JOG	Yes	Yes	Yes	Yes
	JOG INCREMEN- TAL	Yes	Yes	No	Yes
	HOME	Yes	Yes	No	No
	SPINDLE MOVE	Yes	Yes	No	No
Editor	DOWNLOAD	Yes	Yes	No	Yes

Yes: Enabled, No: Disabled

Operating Mode

Operating mode is displayed at the top button on the vertical button bar.

Operating mode	Description
AUTO	Mode where AUTO is performed
MDI	Mode where MDI is performed
Manual	Mode where manual operation (jog, MPG) is performed
Edit	Mode where work offset, tool offset, or CNC compensation table is edited

● Displaying operating mode

Operating mode is displayed at the top button on the vertical button bar.

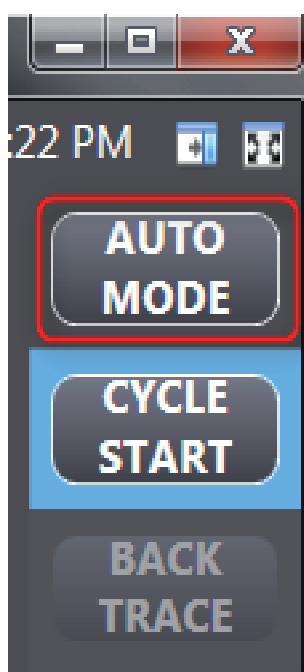

● Switching operating modes

Procedures for switching operating modes of CNC Operator are as follows:

- Switching modes by the operating mode view button
By pressing the top button on the vertical button bar, operating modes are changed in the order of AUTO, MDI, Manual, Edit, AUTO, ... in cycles.
- Switching modes by Tab View
By pressing each function in the Tab View, the operating mode can be changed directly into the selected mode.



Additional Information

From tab view, the mode cannot be changed to edit mode. When Work offset, Tool offset, or CNC compensation table is selected, press the operating mode view button to change to edit mode.

3-5 Tool Offsets/Workpiece Offsets

This section describes the tool offset and workpiece offset settings.

3-5-1 Tool Offset Management

In Tool Offsets, manage data such as tool offsets and operating time.

The device vendor changes or expands the settings in accordance with the connected machine using the sequence control program.

The following table lists the tool data items that are displayed.

Tool Data	Description
Tool Length	Length of tool (writable)
Tool Wear	Wear of tool (read only)
Tool Radius	Tool Radius (writable)
Radius Wear	Radius Wear (read only)
Usage Count	Count of tool usage (read only)
Operating Time	Operating time of tool (read only)

● Screen image

AUTO		QUEUE (0)		MDI		MANUAL		MPG		WORK OFFSETS		TOOL OFFSETS		PITCH COMP		ALARMS (0)	
Tool Index	Tool Length	Tool Wear	Tool Radius	Radius Wear	Usage Count	Operating Time											
1	0.0000	0.0000	0.0000	0.0000	0	0d:0h:0m											
2	0.0000	0.0000	0.0000	0.0000	0	0d:0h:0m											
3	0.0000	0.0000	0.0000	0.0000	0	0d:0h:0m											
4	0.0000	0.0000	0.0000	0.0000	0	0d:0h:0m											
5	0.0000	0.0000	0.0000	0.0000	0	0d:0h:0m											
6	0.0000	0.0000	0.0000	0.0000	0	0d:0h:0m											

● Editing data

- 1 Select **Main View** then **Tool Offsets** to display the screen.



Precautions for Correct Use

The numeric value can only be changed in edit mode. Press the operating mode change button to change to edit mode.

- 2 Select the cell of the item to be changed, and enter a value.

● Exporting data

- 1 Press the **EXPORT** button.
- 2 Select the save location and press the **SAVE** button.
The file is save in CSV (comma separated value) format.

● **Importing data**

- 1 Press the **IMPORT** button.
- 2 Select a file to import, and press the **OPEN** button.



Additional Information

Only Tool Length and Tool Radius are targeted for import.

● **Downloading data**

Press the **DOWNLOAD** button. Data is downloaded to the Controller.

● **Uploading data**

Press the **UPDATE** button. The data stored in the Controller is reflected on CNC Operator.

● **Deleting data**

Click the **CLEAR** button. Among data of the selected line, the controller data (Tool Wear, Radius Wear, Usage Count, and Operating Time) are deleted.

Tool Length and Tool Radius that were entered on CNC Operator are not deleted.

3-5-2 Work Offset Management

In Work Offsets, manage workpiece offset information.

Change or expand the settings in accordance with the connected machine.

Refer to the *NJ/NY-series G code Instruction Reference Manual* (Cat. No. O031) for details.

Compatible G codes	Description
G54 to G59	Set the work offset values of coordinate systems 1 to 6.

● **Screen image**

Offset	X	Y	Z
G54	0.0000	0.0000	0.0000
G55	0.0000	0.0000	0.0000
G56	0.0000	0.0000	0.0000
G57	0.0000	0.0000	0.0000
G58	0.0000	0.0000	0.0000
G59	0.0000	0.0000	0.0000

- **Editing data**

- 1 Select **Main View** then **Work Offsets** tab to display the screen.



Precautions for Correct Use

The numeric value can only be changed in edit mode. Press the operating mode change button to change to edit mode.

- 2 Select the cell of the item to be changed, and enter a value.

- **Exporting data**

- 1 Press the **EXPORT** button.
- 2 Select the save location and press the **SAVE** button.
The file is save in CSV (comma separated value) format.

- **Importing data**

- 1 Press the **IMPORT** button.
- 2 Select a file to import, and press the **OPEN** button.

- **Downloading data**

Press the **DOWNLOAD** button. Data is downloaded to the Controller.

- **Uploading data**

Uploading all data

Press the **UPDATE** button. The data stored in the Controller is reflected on CNC Operator.

Uploading data for each axis

Upload controller data for each axis. Take the following steps to upload.

- (1) Select the target data (coordinate system).
- (2) Select the axis (X, Y, Z) to upload by the button. The target data is uploaded to the table.

3-6 NC Programs

NC programs can be generated in CAD/CAM and displayed on the AUTO tab or full screen editor. NC programs can be created, edited, and monitored.

3-6-1 AUTO

The G Code Editor on the AUTO tab can create new NC programs, as well as load, edit, and monitor NC programs.

The NC program editor can edit and monitor G codes.

Function	Description
Edit	<p>Edits NC programs.</p> <ul style="list-style-type: none"> The lines of an NC program are shown in different colors depending on whether they are G codes, M codes, parameters, or comments. A number is automatically assigned to the head of each line of the NC program transferred to the Controller. These numbers are used by the program to show the lines.
G code monitoring	<p>Monitors the execution of the NC program. The status bar indicates the progress. The current line is highlighted, and the executed line is displayed in light blue. You cannot edit the NC program when it is monitored.</p> <ul style="list-style-type: none"> The progress of the main program is indicated by line number/total line (progress %). The number of a program and a line currently executed are indicated by PROG:LINE program number:line number.

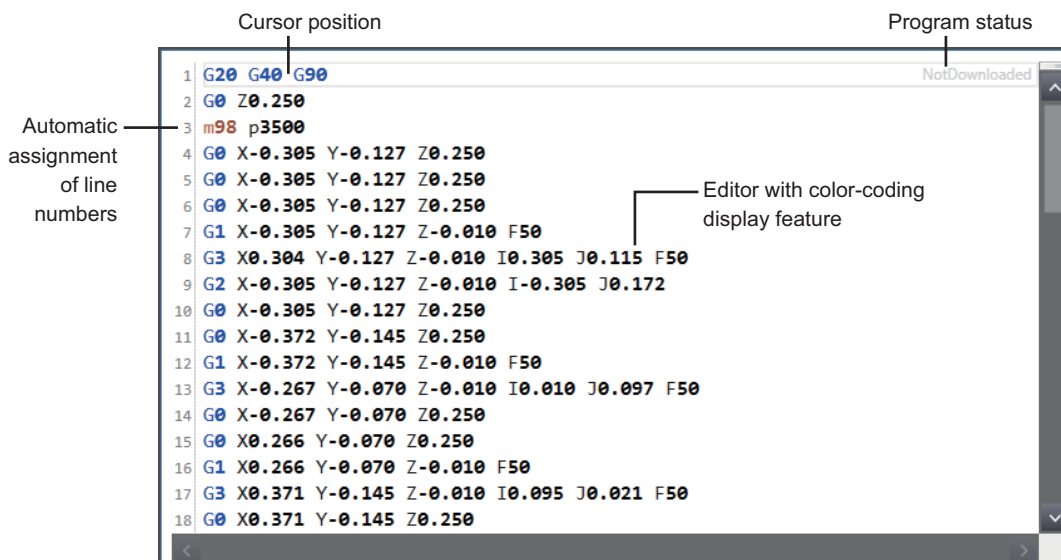

The NC program editor has the following functions.

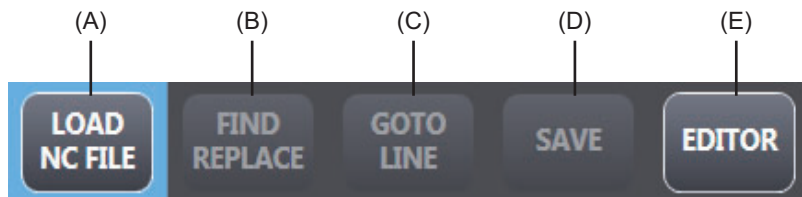

	Function	Description
A	Loading NC File	Loading an NC file.
B	Search and replace	Searching for and replacing the text.
C	Go to the Specified Line	
D	Save	Grayed out when no change is made.
E	Full Screen Editor	The editor transitions to a full screen editor. If you attempt to transit to the editor without saving the data, a confirmation dialog appears prompting you to save the data.

The following table shows the specifications of NC programs that can be used.

Specification	Details
NC file size	The default file size is 5MB. The transferable maximum size varies depending on the target controller. Refer to <i>Setting for NC Program Size</i> on page 3-21.
G code, M code	Supported in the CNC controller version.

3-6-2 Full Screen Editor

The following shows the GUI of the full screen editor.

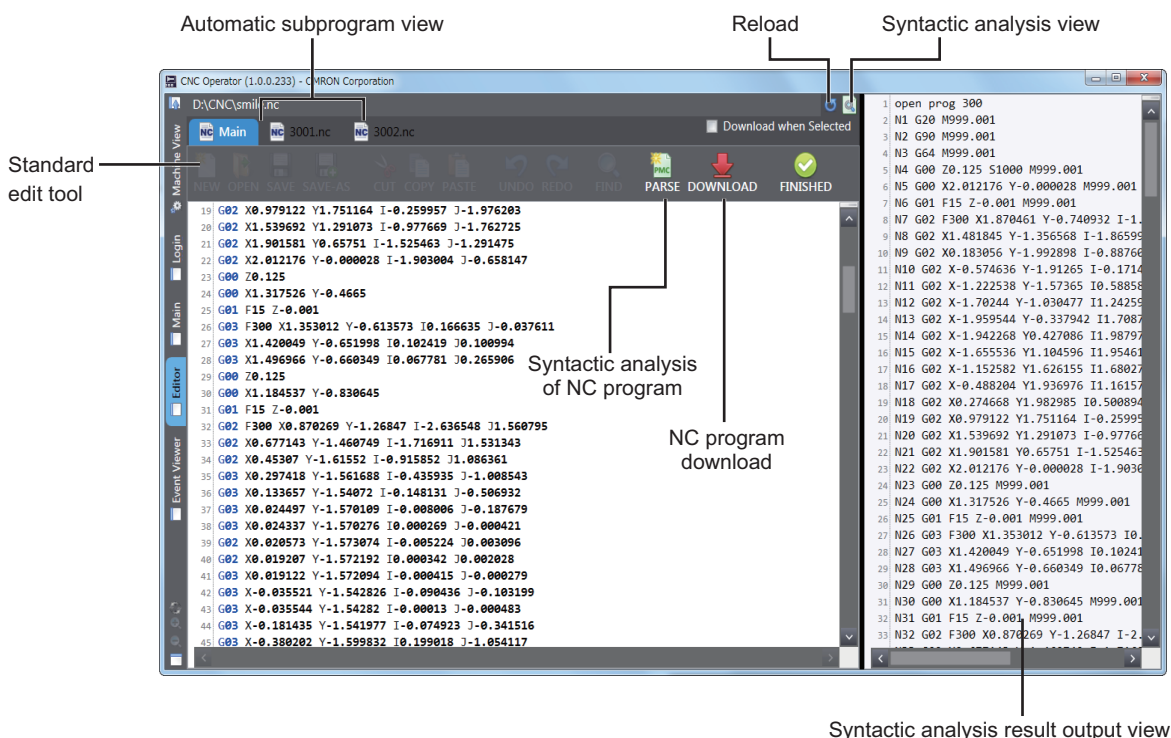

Function	Description
NEW	Creates a new file to store the NC program.
OPEN	Opens a file to store the NC program.
SAVE	Saves a file to store the NC program.
SAVE-AS	Saves a file to store the NC program after assigning a name to it.
CUT	Cuts an area in the editor.
COPY	Copies data in the editor.
PASTE	Pastes data in the editor.
UNDO	Cancel the previous edit operation and returns to the unedited state.
REDO	Re-executes the canceled edit operation.
FIND	Searches text in the editor.
PARSE	Checks the NC program. When the syntactic analysis is completed, the syntactic analysis results are shown in the pane on the right.
DOWNLOAD	Downloads the NC program to the Controller. However, when the Controller is executing another NC program, the download process does not start.
FINISHED	Exits and returns to the Main View.
Download when Selected	If enabled, the program is downloaded when the editor is closed.



Precautions for Correct Use

- When an NC program is analyzed, the NC program currently open is saved automatically.
- NC programs to be analyzed are only the main program and NC subprograms that are referenced by the M98 command in the main program.
- If a subprogram is referenced in the main program, a tab for viewing the subprogram is automatically added after the NC program analysis, and the target subprogram is displayed.

3-6-3 NC Subprograms

Preparing NC Subprograms

CNC Operator handles NC subprograms in the following way.

- Each NC subprogram must be saved in one file. Specify the program number by adding "o" to the top line of the subprogram.
- Specify program numbers 3000 to 9999 for NC subprograms handled by CNC Operator. Other numbers cause an error during the parse process.
- The default location (folder) of NC subprograms is as follows:
 <Name of the HDD with Windows installed>:\OMRON\NC
 The location can be changed by editing the SubProgramFolder entry in the **NC Files** section of the CNCOperator.ini file.
- NC subprogram files have .nc extension.

Invoking and Executing NC Subprograms

The saved subprogram is added to the main program by specifying the program number with the M98 command and parsing the program in the NC program (main program). For details on the M98 command, refer to the *NJ/NY-series G code Instruction Reference Manual* (Cat. No. O031).

Example: Specifying an NC subprogram that was saved with NC subprogram number 3000 from the main program

- NC program (main program)
 M98 p3000
 M30
- NC Subprograms
 o3000
 G1 X100 Y100
 M99



Precautions for Correct Use

An NC subprogram can be parsed by the G code editor after it is invoked to and assigned with the main program with the M98 command. NC subprograms that are not invoked from the main program cannot be parsed.

In the same way, the NC subprogram transferred directly from Sysmac Studio to the controller is also untargeted for parse processing.

Editing NC Subprograms

Only NC subprograms that can be invoked from the NC program (main program) can be edited after verification is conducted.

- 1 Save the NC subprogram to be invoked to the NC subprogram folder.
- 2 Add the code (M98) used to invoke the NC subprogram from the main program, and parse the subprogram in the full screen editor.

- 3 The target subprogram is automatically added to the full screen editor as a new tab. (Automatic subprogram view)
- 4 Edit the added NC subprogram and save it.



Precautions for Correct Use

You cannot create New NC subprograms on CNC Operator. Use NC subprograms previously prepared, or use external text editor to create NC subprograms.

3-6-4 Queue

NC programs are transferred to the Controller one by one. To execute multiple files in series, you can use the Queue tab to specify the order.

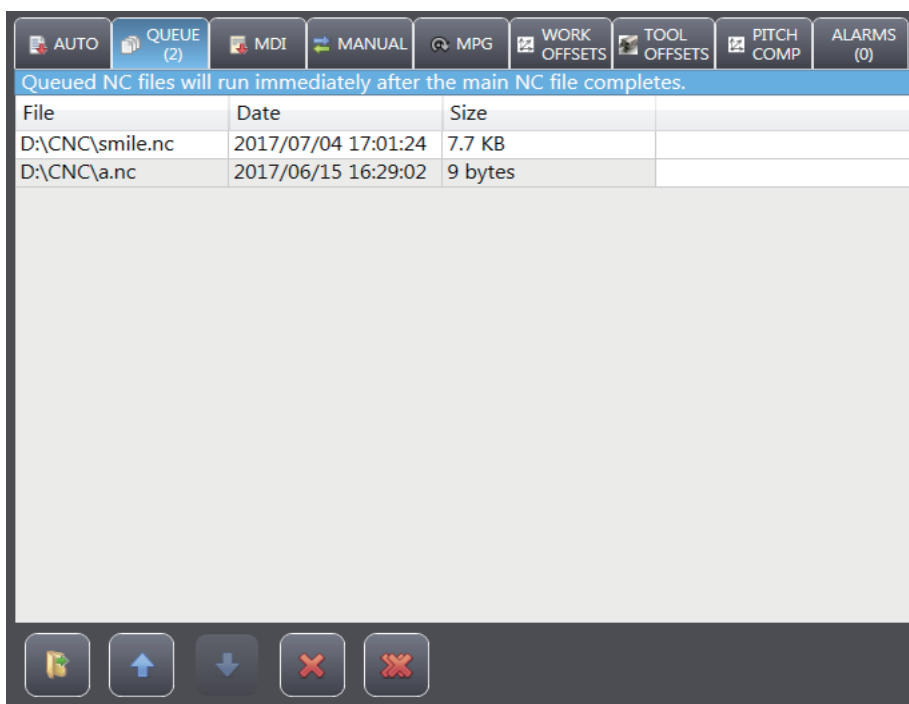

The following functions are available on the Queue tab.

Function	Remarks
Adding an NC program to the queue	---
Raising the priority of an item in the queue	---
Lowering the priority of an item in the queue	---
Deleting an NC program file from the queue	This does not delete the file itself.
Deleting all NC program files from the queue	This does not delete the files themselves.

3-7 MDI (Manual Data Input)

MDI is used to partially check CNC functions.

MDI has the following functions.

Function name	Description
Switching Modes	Switches the mode to MDI to enable the MDI tab.
MDI Tab Editor	Enters, edits, or monitors the NC program to be partially operated.
Cycle Start	Executes the NC program.
Block Execution	Only executes a part of the NC program.
Dry Run	Runs the machine at the feedrate specified by a parameter instead of the feedrate commanded by the NC program without placing workpieces. This function is used to check the program.
Machine Lock	Checks the operation of the NC program without running the machine. When machine lock is enabled, all target axes are temporarily operated as virtual axes. However, the S-axis will not be affected.
Aux Lock	This is an auxiliary function of dry run and machine lock. It works so as not to run M and the spindle S-axis.
Feedrate Override	Checks the operation using rapid and slow feedrate. Set Override for each of the feedrate (Feed ((X,Y,Z,A,B,C)) and spindle S velocity (Spindle).

3-7-1 Switching Modes

The vertical button bar provides the button to change to the MDI mode.

● Screen image



MDI Tab

The **MDI** tab allows you to create, edit, and monitor NC programs. Unlike the **AUTO** tab, this tab does not support loading of programs one by one.

The NC Program Editor has two areas: the editing area and the monitoring area.

Area	Description
Editing area	Edits NC programs. The following operations are available in the editing area. <ul style="list-style-type: none"> Shows NC codes in different colors according to the code type (G, M, parameter, comment, etc.). A number is automatically assigned to the head of each line of the NC program transferred to the Controller. These numbers are used by the program to show the lines.
Monitoring area	Monitors the execution of the NC program. The status bar indicates the progress. The current line is highlighted, and lines that have been executed are shown in a light color. You cannot edit the NC program when it is monitored.

The sizes of those two areas can be adjusted.

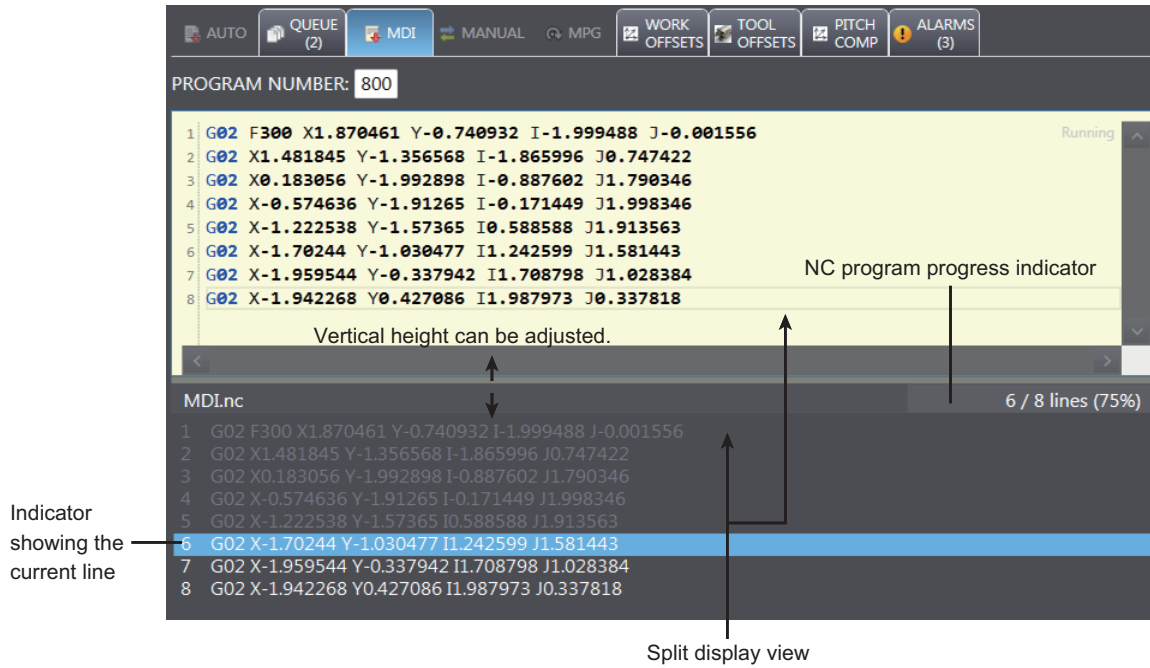

3-7-2 Vertical button bar

You can operate the connected CNC machine from the vertical button bar.

Cycle Start

The **Cycle Start** button starts the NC program. In MDI mode, the NC program on the **MDI** tab is executed.

- **Screen image**



FEED HOLD

The **Feed Hold** button stops the running NC program. To restart, press the **Cycle Start** button again.

- **Screen image**



RESET

The **Reset** button stops the currently running NC program. The program number that is operating is initialized.

- **Screen image**



Block Execution

This function allows you to select a part of the NC program as nonexecutable lines, and to execute only the intended part of the program. CNC Operator has the following functions.

Function	Description
OPTION STOP	Defines all the marked lines in the NC program as nonexecutable lines.
SINGLE BLOCK	Executes the NC program on a line-by-line basis.
BLOCK SKIP	Executes the NC program in units of multiple lines (a block).

● Screen image



Button	Description
OPTION STOP	Enables and disables the Option Block Skip function. The default setting is OFF.
SINGLE BLOCK	Enables and disables the Single Block Skip function. The default setting is OFF.
BLOCK SKIP	Enables and disables the Block Skip function. The default setting is OFF.

Press the **BLOCK SKIP** button, the screen to select the number to be skipped is displayed. Multiple numbers can be selected.

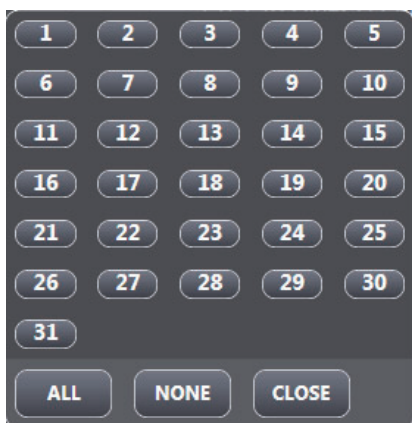

Additional Information

For information how to specify the block skip number on the NC program, refer to *NJ/NY-series G code Instruction Reference Manual* (Cat. No. O031).

Dry Run

Runs the machine at the feedrate specified by a parameter instead of the feedrate commanded by the NC program without placing workpieces. This function is used to check the program.

● Screen image



- It can be operated in **AUTO** or **MDI** mode. The button is not enabled in **MANUAL** mode.
- Press the **Dry Run** button to enable Dry Run. Pressing the **Cycle Start** button starts the NC program while Dry Run is enabled.
- To stop Dry Run, press the **RESET** button.
- If it is switched to offline, Dry Run is reset.

Machine Lock

The machine lock executes an NC program without outputting command values to the assignment axis. This function is used to calculate only a path using the Controller without operating the actual axes.

● Screen image

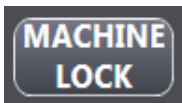

- It can be operated in **AUTO** or **MDI** mode. The button is not enabled in **MANUAL** mode.
- Press the **Machine Lock** button to enable Machine Lock. Pressing the **Cycle Start** button executes the NC program while Machine Lock is enabled.
- To stop Machine Lock, press the **RESET** button.
- If it is switched to offline, Machine Lock is reset.

Auxiliary Function Lock

Auxiliary function lock executes an NC program with M codes disabled. This function is used to check only G codes on the actual machine.

● Screen image

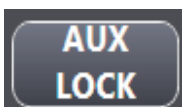

- It can be operated in **AUTO** or **MDI** mode. The button is not enabled in **MANUAL** mode.
- Press the **Aux Lock** button to enable Auxiliary Function Lock. Pressing the **Cycle Start** button executes the NC program while Auxiliary Function Lock is enabled.
- To stop Auxiliary Function Lock, press the **RESET** button.
- If it is switched to offline, Auxiliary Function Lock is reset.

Logout

This button is to return to the login screen.

- **Screen image**



3-7-3 Soft Control Panel (Velocity Override)

This function sets override of feedrate and spindle.

Feedrate

You can set the feedrate from below menu.

- Screen image

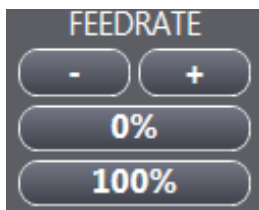

Button	Description
-	Reduces the current override value in decrements of 10%. The minimum value is 0%.
+	Increases the current override value in increments of 10%. The maximum value is 500%.
0%	Sets the override value to 0%.
100%	Sets the override value to 100%.

Spindle

You can change the spindle velocity from below menu.

- Screen image

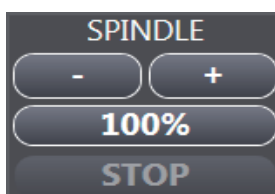

Button	Description
-	Reduces the current override value in decrements of 10%. The minimum value is 0%.
+	Increases the current override value in increments of 10%. The maximum value is 500%.
100%	Sets the override value to 100%.
STOP	Stops the spindle started by M code.

Spindle Button

The spindle operation is available as a manual operation function.

Function name	Description
START	Pressing the button rotates the spindle axis.
STOP	Pressing the button stops the spindle axis that is rotating.
ORIENTATION	Pressing the button rotates the spindle axis to the defined phase position.
CW	Rotates clockwise. (Default)
CCW	Rotates counterclockwise.

● Screen image

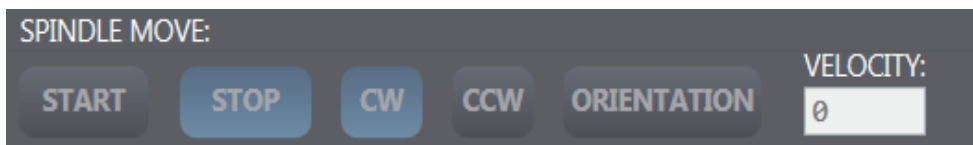

Utilities

Displays the buttons to perform SERVO ON, SERVO OFF, or ERROR RESET. Also, this option displays the SERVO ON, HOMED, and controller status.

● Screen image



You can run the following functions.

Function name	Description
SERVO ON	Applies Servo ON to all the CNC motors.
SERVO OFF	Applies Servo OFF to all the CNC motors.
ERROR RESET	Resets errors.

The following statuses can be checked.

Status	Description
SERVO ON	Lights up green when all the CNC motors are in Servo ON state.
HOMED	Lights up green when all the CNC motors are in Homed state.
ERR/ALM	Lights up green when no status error occurs in the CPU Unit, and lights up red when an error occurs.

3-7-4 Manual Mode

Jogging, homing, MPG, and spindle operations are available in **MANUAL** mode. These functions only run in **MANUAL** mode. The **MANUAL** tab is not enabled in **AUTO** or **MDI** mode.

Jogging

The following jogging options can be selected.

Button	Description
Jog speed x (1 to 5)	Changes the jogging speed. Each value can be changed in the Machine View.

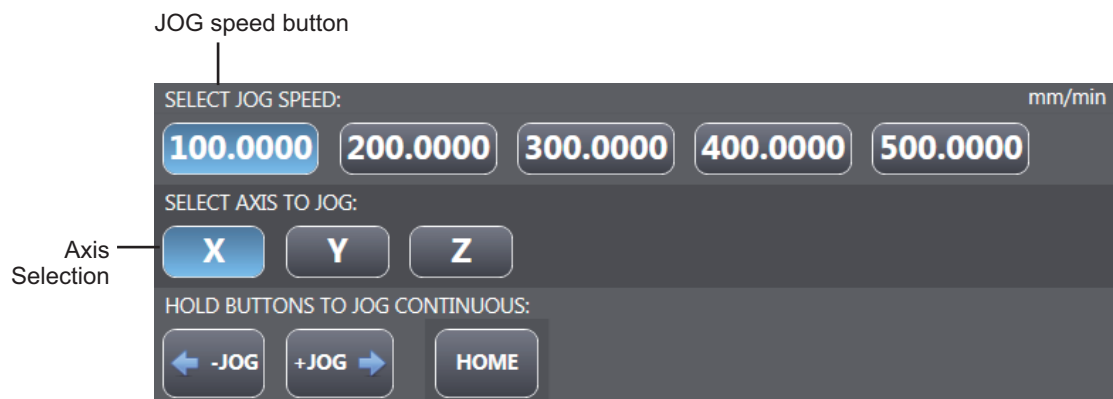

- Use the X, Y, or Z button to select the target axis.
- Press **+Jog** to rotate the motor axis clockwise.
- Press **-Jog** to rotate the motor axis counter-clockwise.

Relative Velocity

Moves by inching the feed axis selected for jogging according to the specified relative movement distance, direction, velocity, and acceleration/deceleration.

● Screen image

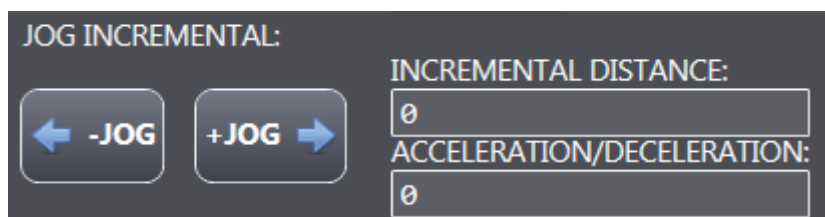

- Specify the Incremental Distance and Acceleration/Deceleration values.
- Press **+Jog** to rotate the motor axis clockwise.
- Press **-Jog** to rotate the motor axis counter-clockwise.

Homing

Performs Homing or Homed processing.

- **Screen image**



- Press the **HOME** button to start homing.
- To stop homing, press the **Cancel** button in the dialog box that is displayed during homing.

MPG

Configure the MPG (manual pulse generator) settings.

- **Screen image**

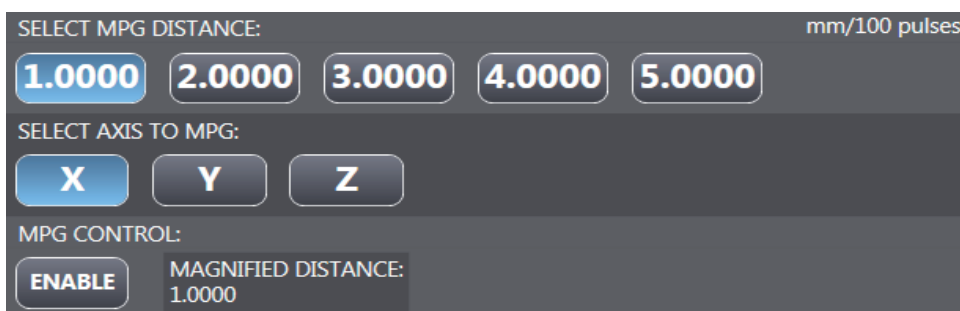

The following settings are available.

Function	Description
SELECT MPG DISTANCE	Changes feed travel distance of MPG operation. Each value can be changed in the Machine View. The actual travel distance value is displayed below the button.
SELECT AXIS TO MPG	Set the MPG target axis.
MPG CONTROL	Enables MPG.

3-8 Test Run

This section describes the machine adjustment procedure used when a machine is operated for provisional cutting and other testing purposes.

3-8-1 CNC Motor Compensation

Rewrite the value of the compensation table on the CNC Controller. This function is available only when connected online to prevent the values from being rewritten unintentionally. If the project is connected online, setting data is loaded from the CNC Controller.

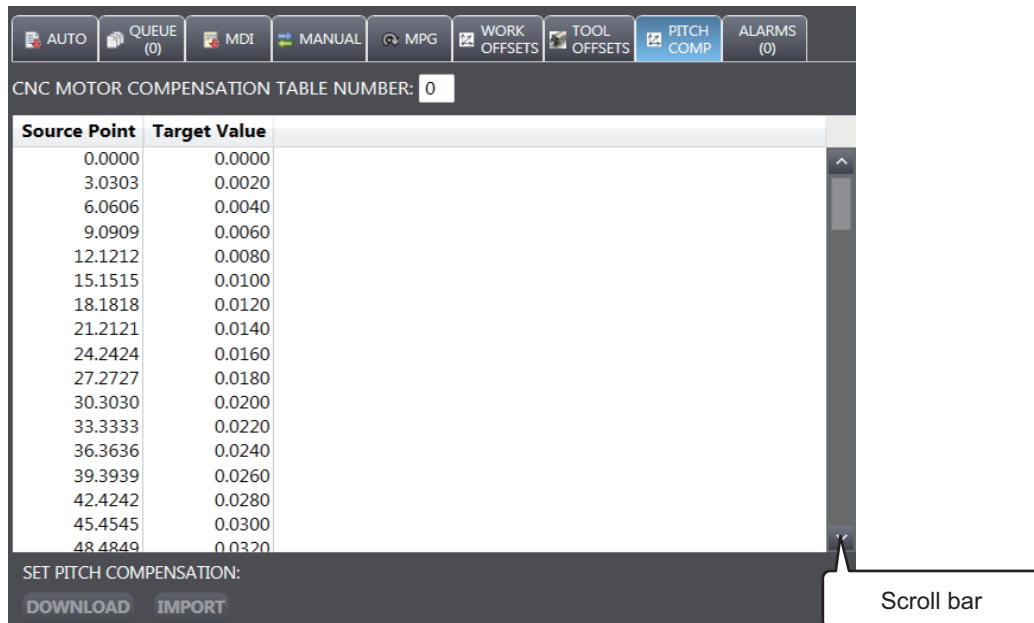

The following operations are available using this function.

- Specify the CNC motor compensation table number.
- Press the **IMPORT** button to import an external file.
- Rewrite the setting data loaded from the CNC Controller on the compensation table, and download it to the CNC Controller.

The external file must be written in the following CSV format using a fixed point.

<Integer part>. <Decimal part (maximum five digits)> ,

Example: For compensation table data containing 100 rows

0.0000,

0.0001,

0.0002,

...

0.0099,

You cannot use the floating-point format, e.g., 0.1234567e-01.



Precautions for Correct Use

The download and import functions are only available in **Edit** mode.

3-8-2 Correction of NC Program

If an NC program has a problem, take the following actions.

- On the **MDI** tab, confirm the program to be fixed.
- On the **AUTO** tab, download the program that you fixed again.

3-8-3 Simulation

Use the Sysmac Studio to simulate the CNC Controller operations. Refer to the *Sysmac Studio Version 1 Operation Manual* (Cat. No. W504) for details of the simulation functions.

- 1** Start the Sysmac Studio, then open a project (for which the sequence program, NC programs, and CNC Operator settings are set) used for the CNC machine.
- 2** Start the Simulator, and transfer the project to the Simulator.
- 3** Change the connection destination of CNC Operator to the Simulator.
Refer to *Simulated* on page 3-9 for information about how to switch to the Simulator.
- 4** Run various operations using the CNC Operator.

3-9 Field Operation

After checking the safety of cutting operations and other machine operations through Test Run, start Field Operation (actual operation). This section describes how to start the machine and functions that are available during operations.

3-9-1 Connection with CNC Controller

When you start the device, CNC Operator starts to establish a connection to the Controller.

Connectable Devices

CNC Operator can be connected to NJ/NY Controllers that support the CNC functions.

Target model	Description
NJ501-5300	NJ/NY-series NC integrated controller
NY532-5400-11□□□□□□□□	

Controllers that are not specified in the above table cannot be connected. If CNC Operator is connected to a controller other than the above, an error message is displayed, which causes the non-connection state.

Connection Procedure

The following provides the procedure to connect CNC Operator to the NJ/NY Controllers.

- 1** Start CNC Operator.
- 2** Open Machine View screen, and select **Controller** at the top of the tree.
- 3** Enter the IP address of the Controller to be connected, and press the **Apply** button.
- 4** Press the  (Connect) button.
- 5** Press the **Start** button.

The Controller enters a ready-to-start status. The coordinate system number is 1 by default.

3-9-2 Display of the Running Program and the Path

Display NC program information when the NC file is loaded. This information is displayed on the upper part of the axis parameter window.

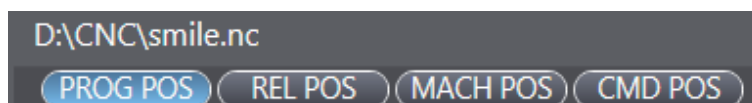

3-9-3 Login User Information

Displays the current login user. This information is displayed on the right side of the axis parameter window, together with the current date and time.

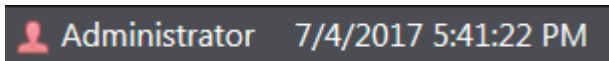

3-9-4 Functions to Change Screen Display

Use the following functions to change the display status of CNC Operator.

Function	Operation
Full screen	Displays the application in full screen mode. When you select this function again in full screen mode, the display returns to the previous size.
Viewing message log	Displays the message log view area in the right-hand part of the window. When you select this function again in message log view mode, the message log view area is hidden.
Sub screen display	Displays each view other than Machine View on another screen.
Zoom In/Zoom Out	Zooms in and out of the configuration elements on the screen. The current zoom-in ratio up to 100% is displayed below the + button.



3-9-5 Alarms

The **ALARMS** tab displays the currently detected alarm or information.

- The displayed alarm or information is identified by the date/timestamp, and displayed in the message log.
- When several confirmation messages appear, all of them can be cleared by right-clicking on the **ALARMS** screen and selecting *Acknowledge All Alarms*.

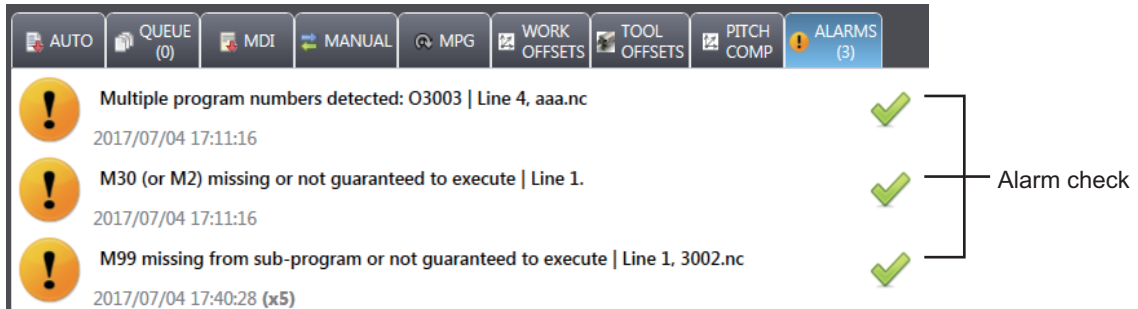

Icon	Name	Description
	WARNING	The persistent alarm remains active until the failure that has caused the message is cleared.
	Confirmation	The confirmation message is displayed with a check mark on the right. The message is cleared by pressing the check mark.
	Information	Displays the CNC Operator status.

3-9-6 Message Status Bar

The status bar is displayed at the bottom of the application screen to indicate the status of CNC Operator.



3-9-7 Watchdog Indicator

At the lower left of the application screen, an icon indicating the connection status between CNC Operator and the Controller is displayed.

The icon whirls when CNC Operator is connected to the Controller.

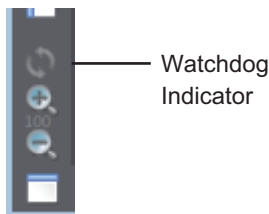

3-9-8 NC Parameter Window

Displays NC parameters.

UNITS	MM (G21)
FEEDRATE	CMD: 0.00 ACT: 0.39 OVERRIDE: 100%
SPINDLE	CMD: 1,000.00 ACT: 0.00 OVERRIDE: 100%
G-CODES	G01 G64 G17 G21 (G54-G59 Disabled) G90 G40 G49 G50 G50.1 G69 G98 G501

The following items are displayed in the NC parameter window. All the parameters are set to read only mode.

Item	Description
UNITS	Unit (inch or mm) used, and corresponding G codes (G20/G21)
FEEDRATE	Result value, command value, override value
SPINDLE	Result value, command value, override value
G-CODES	Valid G code in each group of the currently executed NC program

3-9-9 Axis Parameter Window

Displays axis parameters.

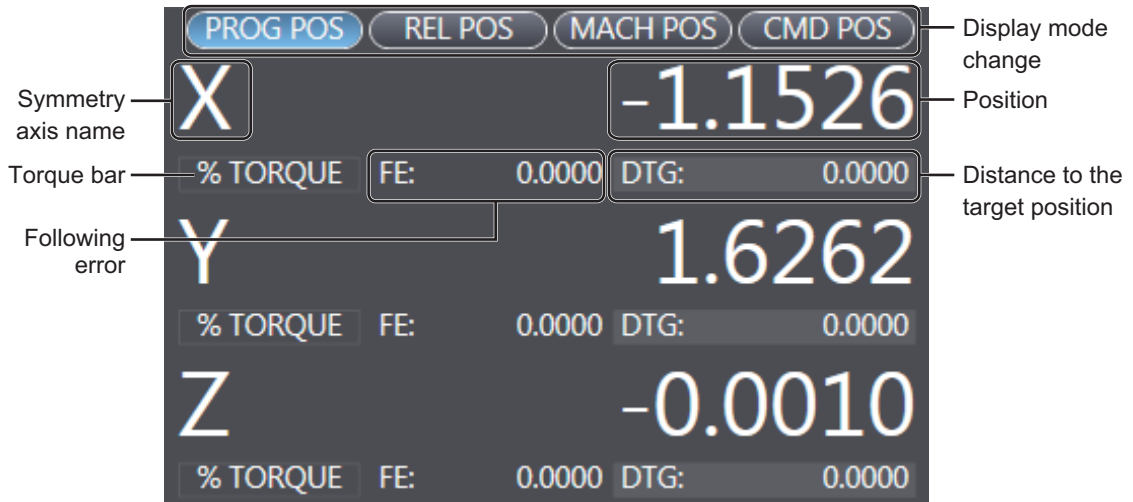

Item	Operation
Display mode change	Pressing an area switches the position to the following corresponding view value. <ul style="list-style-type: none"> • Calculation result position • Relative position • Machine coordinate position • Commanded position
Symmetry axis name	Name of the axis to be displayed
Torque bar	Indicates the torque state (0 to 100%) by the length of the blue bar.
Position	Present axis value Refer to <i>Display mode change</i> on page 3-53 for details.
FE	Following error value
DTG	Distance to the target position

Precautions for Correct Use

The relative position is set to 0 if you press the **REL POS** button during NC program operation.

3-10 Troubleshooting

This section describes operations that are required when a problem occurs.

3-10-1 Event Viewer

Displays system events and user-defined events inside the Controller. The Controller errors can be cleared individually or collectively. For details on the event viewer, refer to the *Sysmac Studio Version 1 Operation Manual* (Cat. No. W504).

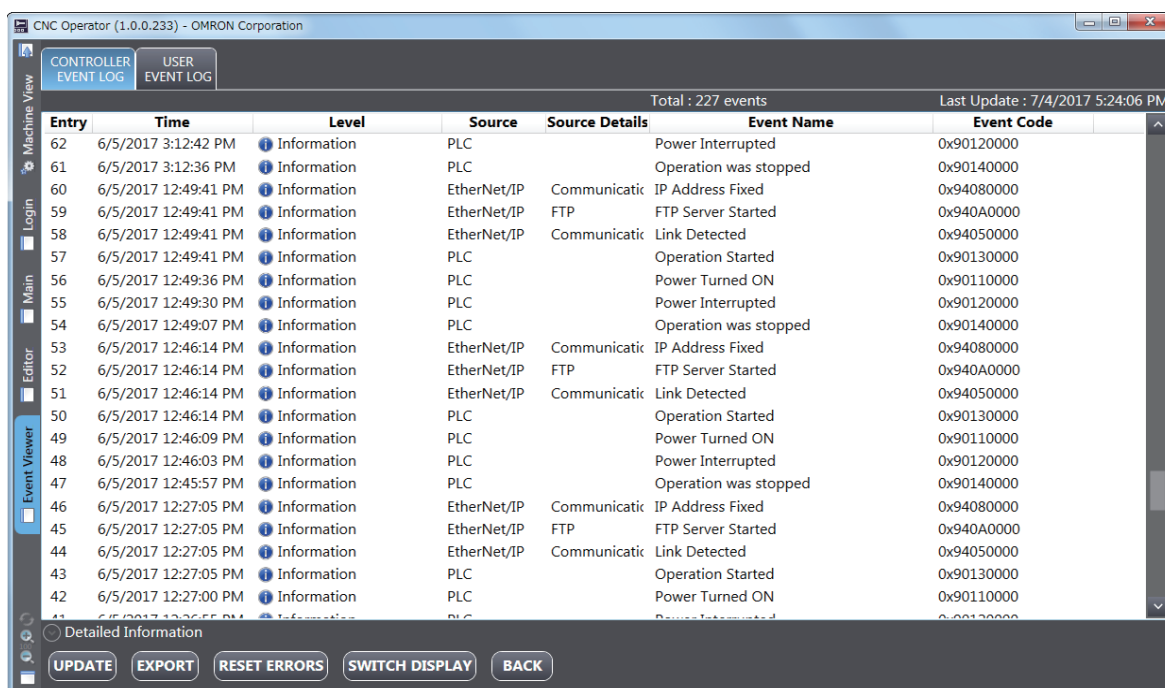

Item	Description
CONTROLLER EVENT LOG	Displays event logs of the connected controller.
USER EVENT LOG	Displays user event logs of the connected controller.
Detailed Information	Displays detailed information for each event.

Function	Description
UPDATE	Displays the latest information.
EXPORT	Outputs event logs to a file.
RESET ERRORS	Resets a controller error.
SWITCH DISPLAY	Switches the Attached Information View and the Action and Correction View for the detailed information.
BACK	Returns to the main view.



Precautions for Correct Use

When the Simulator is connected, the event viewer function is not available.

3-10-2 Back Trace

The Back Trace function traces the operation path in reverse order.

● Screen image

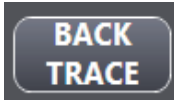

- It can be operated in **AUTO** or **MDI** mode. The button is not enabled in **MANUAL** mode.
- After enabling Back Trace using the **Back Trace** button, press the **Cycle Start** button to start Back Trace.
- To stop Back Trace, press the **RESET** button.



Precautions for Correct Use

Pressing the **RESET** button stops the operations of the entire NC program. You cannot interrupt only Back Trace.

3-11 Starting from the Sysmac Studio

You can start CNC Operator from Sysmac Studio. When CNC Operator is started from Sysmac Studio, the CNC coordinate system, CNC motor, CNC motor compensation table, destination's IP address, and FTP setting configured by Sysmac Studio are transferred to CNC Operator through the configuration file. This helps save time as the motor axis and coordinate system settings do not need to be configured again on CNC Operator.

The following shows the procedure to inherit the CNC settings from Sysmac Studio and start CNC Operator.

- 1 Start Sysmac Studio and configure the CNC settings.



Precautions for Correct Use

If the CNC coordinate system settings are not configured, the following error occurs and Sysmac CNC Operator cannot be started.

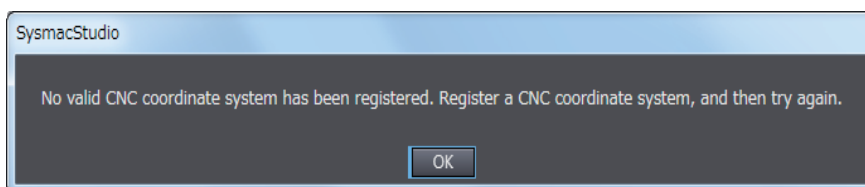

- 2 Select *Tool -> Launch External Application -> CNC Operator*.
- 3 Specify the CNC coordinate system to inherit and the path where CNC Operator is installed, then press the **OK** button.

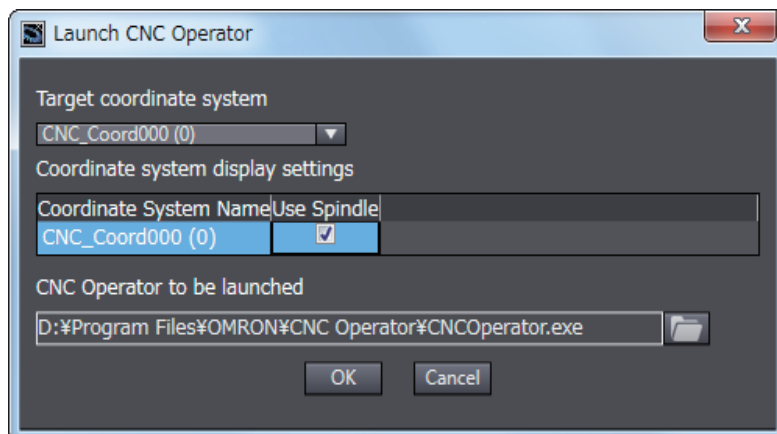

Precautions for Correct Use

When settings are inherited from Sysmac Studio on Windows installed in the NY-series CNC Controller before CNC Operator is started, the IP address specified by Sysmac Studio is not inherited. Manually specify the IP address of CNC Operator. The default IP address is 192.168.254.1.



Appendices

A

A-1 Customization by SDK	A-2
A-2 Setting SYSMAC Gateway, Communications Middleware	A-3
A-3 Heartbeat Configuration Example	A-7

A-1 Customization by SDK

Optional Sysmac CNC Operator Software Development Kit (SYSMAC-RTNC0101D) can be used to customize CNC Operator functions.

For details, refer to the help manual attached to CNC Operator Software Development Kit (SYSMAC-RTNC0101D).

A-2 Setting SYSMAC Gateway, Communications Middleware

CNC Operator performs data exchange with the sequence control program by reading and writing variables registered in the CNC Controller via EtherNet/IP message communications.

CNC Operator uses the SYSMAC Gateway communications middleware for EtherNet/IP message communications.

This section describes SYSMAC Gateway settings required to establish a communication between CNC Operator and CNC Controller.

Refer to the online help for details on SYSMAC Gateway. You can access the online help by implementing the following procedure.

- From the Windows Start menu, select **All Programs - OMRON - Sysmac Gateway - Sysmac Gateway Help**.



Precautions for Correct Use

- If CNC Operator cannot be connected to the CNC Controller, check that the SYSMAC Gateway communication service is started and that the Ethernet network port is opened.
 - While CNC Operator is connected to the CNC Controller, do not stop the SYSMAC Gateway communication service and do not close the Ethernet network port.
 - If the connection cannot be established even though the Ethernet network port is open, check the following:
 - a) the IP address of the destination is correct
 - b) the power to the Controller is turned ON
 - c) the cable is correctly connected
 - d) hubs or other network devices are not malfunctioning
 - e) settings of the SYSMAC Gateway Ethernet network port are correct
 - f) the Windows firewall software is not blocking communication packets
 - g) the Use Option for the CIP message server is selected in the CNC Controller
 - h) when Packet Filter of the CNC Controller is used, packets used by CNC Operator are allowed. For details on Packet Filter settings, refer to Packet Filter in the NJ/NX-series CPU Unit Built-in EtherNet/IP Port User's Manual (Cat. No. W506).
-

Starting SYSMAC Gateway Console

The SYSMAC Gateway settings must be configured in SYSMAC Gateway Console. Perform the following procedure to start SYSMAC Gateway Console.

- From the Windows Start menu, select **All Programs - OMRON - SYSMAC Gateway - SYSMAC Gateway Console**.

SYSMAC Gateway Console starts and the following window is displayed.

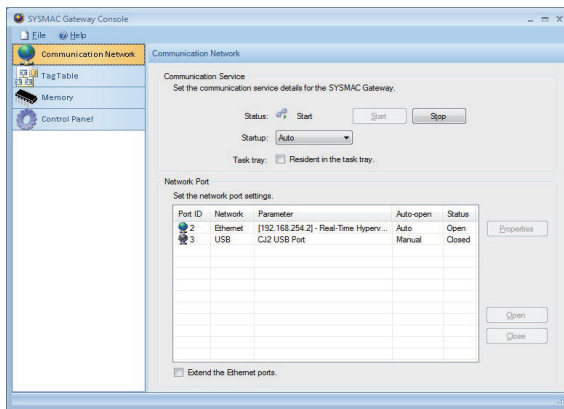

Setting the Network Port

The network port settings is required to establish an EtherNet/IP communication with the CNC Controller.

To configure the network port settings, select **Communication Network** on the **Control** tab of SYSMAC Gateway Console.

Select **Port ID 2, Ethernet** from the **Network Port** list, and click the **Properties** button.

Configure the following settings.

Item	Description
Automatically open port at startup	Enable this setting to open the network port automatically when the SYSMAC Gateway communication service is started.
LAN Card	Specify the network card to communicate with the CNC controller. When connecting to the NY-series CNC Controller, select Real-Time Hypervisor PCI Network Adapter .
IP Address	Specify the IP address of the network card that you specified for LAN Card . When multiple IP addresses are specified for the network card, select the IP address of the same network address as for the destination CNC Controller.

The following example shows a case of connecting to the NJ-series CNC Controller (default IP address: 192.168.250.1).

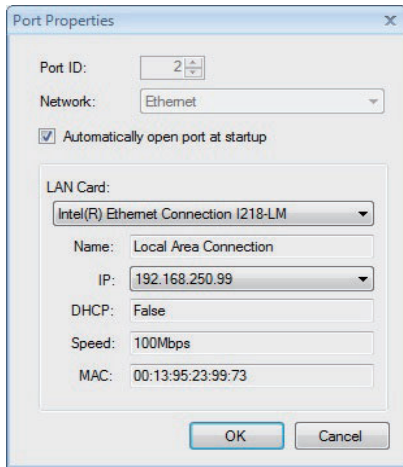

The following example shows a case of connecting to the NY-series CNC Controller (default IP address: 192.168.254.1).

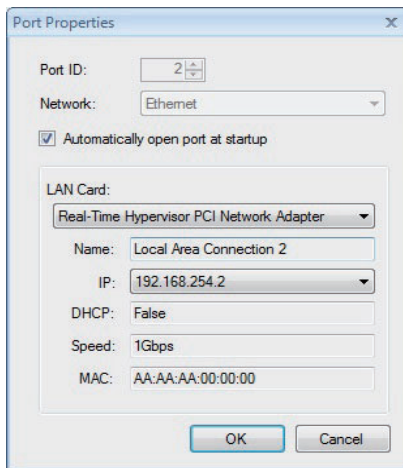

Starting and Stopping Communications Service

To communicate CNC Operator with the CNC controller, start the SYSMAC Gateway communication service, and open the Ethernet network port.

Click the **Start** button or **Stop** button on the Communications Network window to operate the communications service.

Select **Auto** for the start-up type to start communications automatically when the computer boots up.

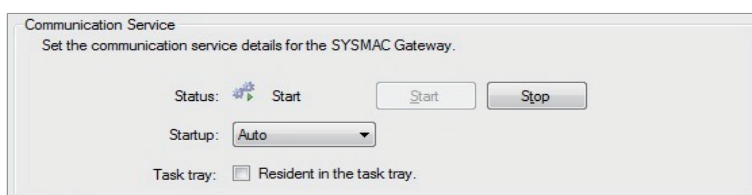

Opening or Closing the Network Port

If *Autocratically open port at startup* option is selected for network port properties, the network port automatically opens when the SYSMAC Gateway communications service is started.

To operate the network port manually, select the Ethernet network port from the **Network port** list, and click the **Open** button or **Close** button.

A-3 Heartbeat Configuration Example

When creating an original sequence control program to transfer data mutually between the CNC Controller and CNC Operator, configure the sequence control program and CNC Operator program (when using Software Development Kit), taking heartbeats into account.

The following example shows a control circuit to stop the device safely even if CNC Operator stops in the sequence control program. The control circuit performs heartbeat processing between CNC Operator and CNC Controller, and stops the device if heartbeats are lost.

Sequence Control Program Description Example

On the CNC Controller's ladder program, configure a circuit to monitor the ON/OFF state of a specific bool value variable at the specified interval (example: 5 sec.). In this example, wHeartBeatSig and winvHeartBeatSig are monitored by AccumulationTimer. If a monitoring error (timeout) occurs, the specified bool value variable is set to ON to notify CNC Operator of the error.

Describe a circuit to stop the machine safely, for example, to stop all axes when above mentioned variable is ON.

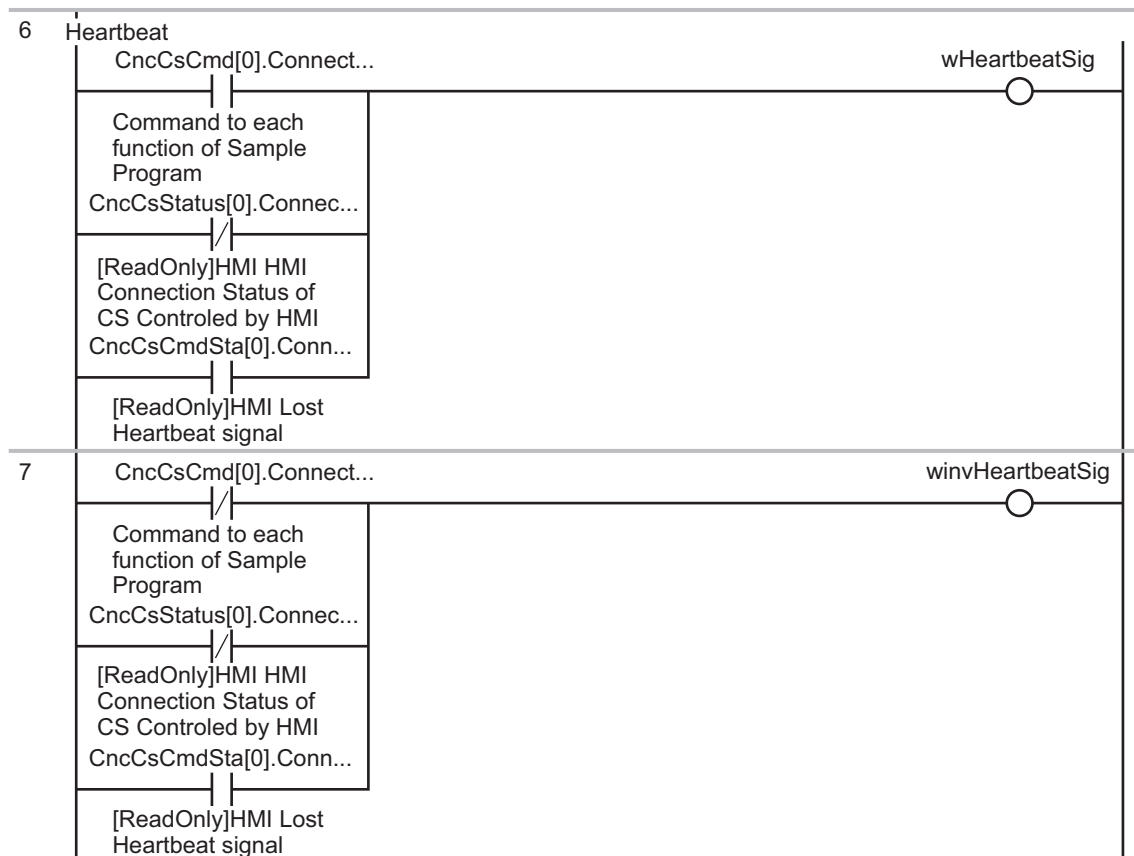

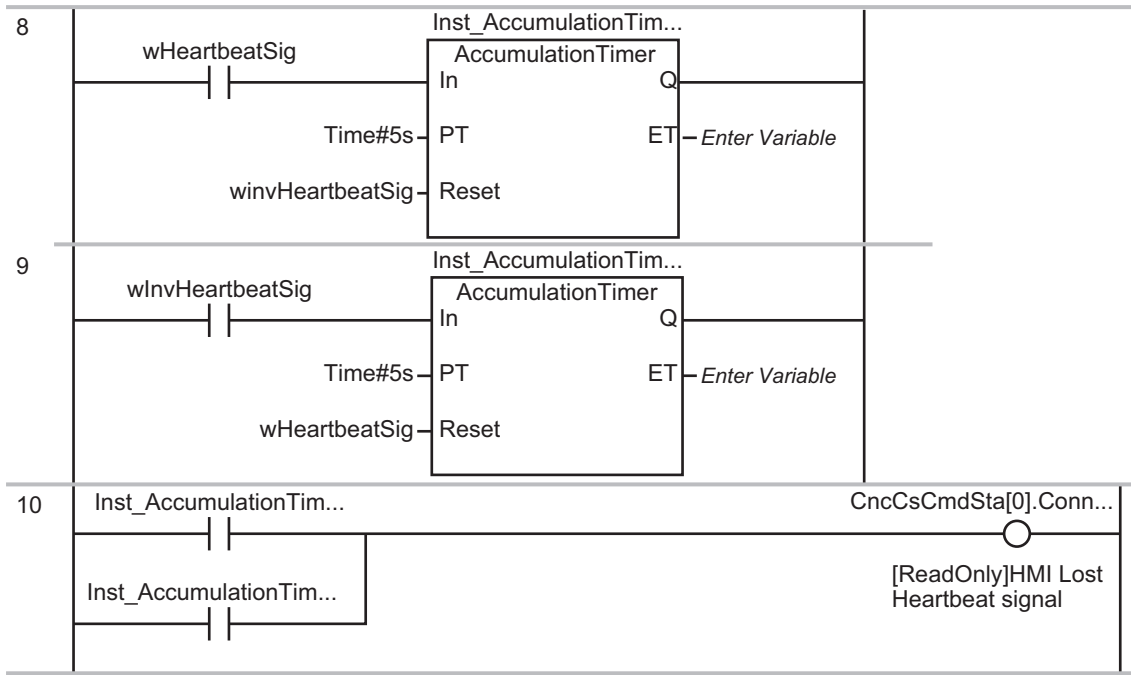

Program Description Example Using CNC Operator

The following example shows a case of creating a heartbeat configuration application program using CNC Operator Software Development Kit. The specific bool value variable indicating the timeout is read at the specified intervals. If the bool value is set to ON, the program notifies the user of a timeout error.

```
// Variable reading setting at specified interval
this.heartbeatTimer = new Timer(1000); // 1 second timer
this.heartbeatTimer.Elapsed += this.OnHeartbeatElapsed;

// Variable reading and update processing
private void OnHeartbeatElapsed(object sender, ElapsedEventArgs elapsedEventArgs)
{
    this.heartbeatTimer.Enabled = false;
    this.heartbeat.Value = !this.heartbeat.Value;
    this.heartbeatTimer.Enabled = true;
}
```



Index



- A**
-
- Actual spindle 3-12
 - Alarms 3-51
 - Attached Information 3-54
 - AUTO 3-26, 3-28
 - Aux Lock 3-37
 - Auxiliary Function Lock 3-41
 - Axis Parameter Window 3-53
 - Axis Settings 3-10
- B**
-
- Back Trace 3-55
 - Block Execution 3-37, 3-40
 - Block skip 3-40
- C**
-
- CAD/CAM 2-6, 3-32
 - CNC Controller 1-2, 3-49
 - CNC coordinate system 2-5
 - CNC Motor Compensation 3-47
 - command spindle 3-12
 - Commanded Position 3-11
 - console 1-2
 - Controller event log 3-54
 - CSV 3-29, 3-31, 3-47
 - Current Line 3-12
 - CW/CCW 3-44
 - Cycle Start 3-37, 3-39
- D**
-
- debugging 2-6
 - Device Status 3-8
 - Display of the Running Program and the Path 3-49
 - download 3-47
 - Downloading 3-30, 3-31
 - Dry Run 3-37, 3-41
 - DTG 3-53
- E**
-
- Edit 3-28
 - Editor 3-6, 3-7, 3-26
 - Elapsed time 3-12
 - ERR/ALM 3-44
 - ERROR RESET 3-44
 - Event Viewer 3-7, 3-54
 - Executing Status 3-12
 - EXPORT 3-54
 - Exporting 3-29, 3-31
- F**
-
- FE 3-53
 - FEED HOLD 3-39
 - Feedrate 3-43
 - Feedrate Override 3-37
 - FTP 2-5, 3-9
 - FTP login user name 3-9
 - FTP password 3-9
 - FTP port number 3-9
 - Full screen 3-4, 3-50
 - Full Screen Editor 3-34
- G**
-
- G Code Editor 2-6, 3-32
 - G code monitoring 3-32
 - G-CODE PARSE 3-34
- H**
-
- Heartbeat A-7
 - HOMED 3-44
 - Horizontal bar 3-6, 3-26
- I**
-
- IMPORT 3-47
 - Importing 3-30, 3-31
 - ini file 3-16
 - Installation 2-2
 - IP Address 3-8, A-4
- J**
-
- Jog Velocity 3-22
 - Jogging 3-45
- L**
-
- Log Values 3-25
 - Login name 3-18
 - Login User Information 3-50
 - Logout 3-42
- M**
-
- M code 3-33
 - M codes 3-16
 - Machine Lock 3-37, 3-41
 - Machine Mode 3-8
 - Machine Position 3-11
 - Machine View 3-5
 - Main View 3-6
 - MANUAL 3-45
 - Manual 3-26, 3-28
 - MDI 3-26, 3-28, 3-37
 - Memo 3-25
 - Message Log 3-19, 3-25
 - Modal Group 3-13
 - Motion axis settings 2-5
 - MPG 3-46
 - MPG Speed 3-23

N

NC Parameter Window	3-52
NC program	3-39
NC Program Size	3-21
NC Programs	3-32
NC Subprograms	3-34, 3-35
.NET Framework	2-2
Network Settings	2-5
Number of Decimal Places	3-22

O

Operating Mode	3-28
Operating Time	3-29
Operator rights	3-17, 3-20
OPTION STOP	3-40
Orientation	3-44

P

Password	3-4
Performs Homing	3-46
Pin	3-14
Program Position	3-11
program sample	2-5
Programming	2-6

Q

Queue	3-26, 3-36
-------------	------------

R

Radius Wear	3-29
Relative Position	3-11
Relative Velocity	3-45
RESET	3-39
RESET ERRORS	3-54

S

SDK	A-2
Search and replace	3-33
Select language	3-4
Servo Drive settings and adjustment	2-5
SERVO OFF	3-44
SERVO ON	3-44
Shut Down	3-17
Simulated	3-9
Simulation Connection	3-48
Single Block	3-40
Soft Control Panel	3-6, 3-26, 3-43
Spindle Override	3-12
Start Up	3-17
Starting and Exiting	3-3
Starting from the Sysmac Studio	3-56
Status Bar	3-6, 3-51

SYSMAC Gateway	2-6, A-3
Sysmac Studio	1-2, 3-56
system configuration	2-4

T

Tab Display	3-19
Technician	3-17
Timeout	3-23, 3-24
Tool	3-12
Tool Length	3-29
Tool Offsets	3-29
Tool Radius	3-29
Tool Wear	3-29
Torque bar	3-53
Transferring	2-5, 2-6

U

Unit	3-21, 3-22
update interval of data	3-18
Uploading	3-30, 3-31
Usage Count	3-29
USB dongle	2-2, 3-3
User event log	3-54
User name	3-4
Utilities	3-44

V

Value History	3-25
Vertical bar	3-6
Vertical button bar	3-26, 3-28, 3-39

W

Watchdog Indicator	3-51
Windows	2-2, 2-3
Workpiece Offset	3-30

Z

Zoom In/Zoom Out	3-50
------------------------	------

OMRON Corporation Industrial Automation Company
Kyoto, JAPAN

Contact: www.ia.omron.com

Regional Headquarters

OMRON EUROPE B.V.

Wegalaan 67-69, 2132 JD Hoofddorp
The Netherlands

Tel: (31)2356-81-300/Fax: (31)2356-81-388

OMRON ASIA PACIFIC PTE. LTD.

438B Alexandra Road, #08-01/02 Alexandra
Technopark, Singapore 119968

Tel: (65) 6835-3011/Fax: (65) 6835-2711

OMRON ELECTRONICS LLC

2895 Greenspoint Parkway, Suite 200
Hoffman Estates, IL 60169 U.S.A.

Tel: (1) 847-843-7900/Fax: (1) 847-843-7787

OMRON (CHINA) CO., LTD.

Room 2211, Bank of China Tower,
200 Yin Cheng Zhong Road,
PuDong New Area, Shanghai, 200120, China

Tel: (86) 21-5037-2222/Fax: (86) 21-5037-2200

Authorized Distributor:

© OMRON Corporation 2017-2022 All Rights Reserved.
In the interest of product improvement,
specifications are subject to change without notice.

Cat. No. O032-E1-03

0622