

E5CN-FR

Limit Controller

USER'S MANUAL

OMRON

E5CN-FR Limit Controller

User's Manual

Produced October 2004

Preface

OMRON products are manufactured for use according to proper procedures by a qualified operator and only for the purposes described in this manual.

The E5CN-FR is a Limit Controller. The main functions and characteristics of the E5CN-FR Limit Controller are as follows:

- Conforms to FM standards (FM3545/3810).
- In addition to thermocouples and platinum resistance thermometers, infrared temperature sensors can be selected as the sensor input type.
- Limit outputs can also be cleared using event inputs.
- Communications are supported. (Applicable to E5CN-FR models with communications.)
- The structure is waterproof (NEMA 4X indoor use, equivalent to IP66).
- Conforms to UL, CSA, and IEC safety standards and EMC Directive.
- The PV display color can be switched to make process status easy to understand at a glance.
- User calibration of the sensor input is supported.
- A protection function enables restricting the setting data that can be used. To comply with FM standards (i.e., to restrict careless changes to settings, such as the limit setting value), set the Operation/Adjustment Protect setting to either 1 or 2 for normal operation. With either of these settings, the Level/Reset Key can be used only as a Reset Key (to reset the limit output).

This manual describes the operation of the E5CN-FR. Read this manual thoroughly and be sure you understand it before attempting to use the Limit Controller and use the Limit Controller correctly according to the information provided. Keep this manual in a safe place for easy reference.

Visual Aids

The following headings appear in the left column of the manual to help you locate different types of information.

Note Indicates information of particular interest for efficient and convenient operation of the product.

1,2,3... 1. Indicates lists of one sort or another, such as procedures, checklists, etc.

© OMRON, 2004

All rights reserved. No part of this publication may be reproduced, stored in a retrieval system, or transmitted, in any form, or by any means, mechanical, electronic, photocopying, recording, or otherwise, without the prior written permission of OMRON.

No patent liability is assumed with respect to the use of the information contained herein. Moreover, because OMRON is constantly striving to improve its high-quality products, the information contained in this manual is subject to change without notice. Every precaution has been taken in the preparation of this manual. Nevertheless, OMRON assumes no responsibility for errors or omissions. Neither is any liability assumed for damages resulting from the use of the information contained in this publication.

Read and Understand this Manual

Please read and understand this manual before using the product. Please consult your OMRON representative if you have any questions or comments.

Warranty and Limitations of Liability

WARRANTY

OMRON's exclusive warranty is that the products are free from defects in materials and workmanship for a period of one year (or other period if specified) from date of sale by OMRON.

OMRON MAKES NO WARRANTY OR REPRESENTATION, EXPRESS OR IMPLIED, REGARDING NON-INFRINGEMENT, MERCHANTABILITY, OR FITNESS FOR PARTICULAR PURPOSE OF THE PRODUCTS. ANY BUYER OR USER ACKNOWLEDGES THAT THE BUYER OR USER ALONE HAS DETERMINED THAT THE PRODUCTS WILL SUITABLY MEET THE REQUIREMENTS OF THEIR INTENDED USE. OMRON DISCLAIMS ALL OTHER WARRANTIES, EXPRESS OR IMPLIED.

LIMITATIONS OF LIABILITY

OMRON SHALL NOT BE RESPONSIBLE FOR SPECIAL, INDIRECT, OR CONSEQUENTIAL DAMAGES, LOSS OF PROFITS OR COMMERCIAL LOSS IN ANY WAY CONNECTED WITH THE PRODUCTS, WHETHER SUCH CLAIM IS BASED ON CONTRACT, WARRANTY, NEGLIGENCE, OR STRICT LIABILITY.

In no event shall the responsibility of OMRON for any act exceed the individual price of the product on which liability is asserted.

IN NO EVENT SHALL OMRON BE RESPONSIBLE FOR WARRANTY, REPAIR, OR OTHER CLAIMS REGARDING THE PRODUCTS UNLESS OMRON'S ANALYSIS CONFIRMS THAT THE PRODUCTS WERE PROPERLY HANDLED, STORED, INSTALLED, AND MAINTAINED AND NOT SUBJECT TO CONTAMINATION, ABUSE, MISUSE, OR INAPPROPRIATE MODIFICATION OR REPAIR.

Application Considerations

SUITABILITY FOR USE

OMRON shall not be responsible for conformity with any standards, codes, or regulations that apply to the combination of products in the customer's application or use of the products.

At the customer's request, OMRON will provide applicable third party certification documents identifying ratings and limitations of use that apply to the products. This information by itself is not sufficient for a complete determination of the suitability of the products in combination with the end product, machine, system, or other application or use.

The following are some examples of applications for which particular attention must be given. This is not intended to be an exhaustive list of all possible uses of the products, nor is it intended to imply that the uses listed may be suitable for the products:

- Outdoor use, uses involving potential chemical contamination or electrical interference, or conditions or uses not described in this manual.
- Nuclear energy control systems, combustion systems, railroad systems, aviation systems, medical equipment, amusement machines, vehicles, safety equipment, and installations subject to separate industry or government regulations.
- Systems, machines, and equipment that could present a risk to life or property.

Please know and observe all prohibitions of use applicable to the products.

NEVER USE THE PRODUCTS FOR AN APPLICATION INVOLVING SERIOUS RISK TO LIFE OR PROPERTY WITHOUT ENSURING THAT THE SYSTEM AS A WHOLE HAS BEEN DESIGNED TO ADDRESS THE RISKS, AND THAT THE OMRON PRODUCTS ARE PROPERLY RATED AND INSTALLED FOR THE INTENDED USE WITHIN THE OVERALL EQUIPMENT OR SYSTEM.

PROGRAMMABLE PRODUCTS

OMRON shall not be responsible for the user's programming of a programmable product, or any consequence thereof.

Disclaimers

CHANGE IN SPECIFICATIONS

Product specifications and accessories may be changed at any time based on improvements and other reasons.

It is our practice to change model numbers when published ratings or features are changed, or when significant construction changes are made. However, some specifications of the products may be changed without any notice. When in doubt, special model numbers may be assigned to fix or establish key specifications for your application on your request. Please consult with your OMRON representative at any time to confirm actual specifications of purchased products.

DIMENSIONS AND WEIGHTS

Dimensions and weights are nominal and are not to be used for manufacturing purposes, even when tolerances are shown.

PERFORMANCE DATA

Performance data given in this manual is provided as a guide for the user in determining suitability and does not constitute a warranty. It may represent the result of OMRON's test conditions, and the users must correlate it to actual application requirements. Actual performance is subject to the OMRON Warranty and Limitations of Liability.

ERRORS AND OMISSIONS

The information in this document has been carefully checked and is believed to be accurate; however, no responsibility is assumed for clerical, typographical, or proofreading errors, or omissions.

Safety Precautions

■ Definition of Precautionary Information

This manual uses the following notation to indicate precautions required to safely operate the E5CN-FR.





The safety precautions that are provided are extremely important to safety. Always read and heed the information provided in all safety precautions.

The following notation is used.









Indicates a potentially hazardous situation which, if not avoided, is likely to result in minor or moderate injury or in property damage.

■ Symbols

Symbol		Meaning
Caution		General Caution Indicates non-specific general cautions, warnings, and dangers.
		Electrical Shock Caution Indicates possibility of electric shock under specific conditions.
Prohibition		General Prohibition Indicates non-specific general prohibitions.
		Disassembly Prohibition Indicates prohibitions when there is a possibility of injury, such as from electric shock, as the result of disassembly.
Mandatory Caution		General Caution Indicates non-specific general cautions, warnings, and dangers.

■ Safety Precautions

 CAUTION	
Do not touch the terminals while power is being supplied. Doing so may occasionally result in minor injury due to electric shock.	
Do not allow pieces of metal, wire clippings, or fine metallic shavings or filings from installation to enter the product. Doing so may occasionally result in electric shock, fire, or malfunction.	
Do not use the product where subject to flammable or explosive gas. Otherwise, minor injury from explosion may occasionally occur.	
Never disassemble, modify, or repair the product or touch any of the internal parts. Minor electric shock, fire, or malfunction may occasionally occur.	
<p>CAUTION - Risk of Fire and Electric Shock</p> <p>a) This product is UL listed as Open Type Process Control Equipment. It must be mounted in an enclosure that does not allow fire to escape externally.</p> <p>b) More than one disconnect switch may be required to de-energize the equipment before servicing.</p> <p>c) Signal inputs are SELV, limited energy.*1</p> <p>d) Caution: To reduce the risk of fire or electric shock, do not interconnect the outputs of different Class 2 circuits.*2</p>	
If the output relays are used past their rated load or life expectancy, contact fusing or burning may occasionally occur. Always consider the application conditions and the inrush current, and use the output relays within their rated load and electrical life expectancy. The life expectancy of output relays varies considerably with the output load and switching conditions.	

*1 An SELV circuit is one separated from the power supply with double insulation or reinforced insulation, that does not exceed 30 V r.m.s. and 42.4 V peak or 60 VDC.

*2 A class 2 power supply is one tested and certified by UL as have the current and voltage of the secondary output restricted to specific levels.

 **CAUTION**

Tighten the terminal screws to between 0.74 and 0.9 N.m. Loose screws may occasionally result in fire.

Set the parameters of the product so that they are suitable for the system. If they are not suitable, unexpected operation may occasionally result in property damage or accidents.

WARNING: To reduce the risk of electric shock or fire, install in a Pollution Degree 2 environment (a controlled environment relatively free of contaminants).

A malfunction in the product may occasionally make control operations impossible or prevent alarm outputs, resulting in property damage to connected equipment and machinery. To maintain safety in the event of malfunction of the product, periodically check the Limit Controller's operation.



Precautions for Safe Use

- 1) Do not use this product in the following places:
 - Places directly subject to heat radiated from heating equipment.
 - Places subject to splashing liquid or oil atmosphere.
 - Places subject to direct sunlight.
 - Places subject to dust or corrosive gas (in particular, sulfide gas and ammonia gas).
 - Places subject to intense temperature change.
 - Places subject to icing and condensation.
 - Places subject to vibration and large shocks.
- 2) Use and store the Limit Controller within the rated ambient temperature and humidity.
When two or more Limit Controllers or Temperature Controllers are mounted close together horizontally or vertically, the heat generated by the Controllers will cause the Limit Controller's internal temperature to rise and shorten the Controller's service life. In such a case, use forced cooling by fans or other means of air ventilation to cool down the Limit Controllers.
- 3) To allow heat to escape, do not block the area around the product.
Do not block the ventilation holes on the product.
- 4) Be sure to wire properly with correct polarity of terminals.
- 5) Use specified size (M3.5, width 7.2 mm or less) crimped terminals for wiring. Use wires with a gage of AWG24 to AWG14 (equal to cross-sectional areas of 0.205 to 2.081 mm²). (The stripping length is 5 to 6 mm.)
- 6) Do not wire the terminals that are not used.
- 7) To avoid inductive noise, keep the wiring for the Limit Controller's terminal block away from power cables carrying high voltages or large currents. Also, do not wire power lines together with or parallel to Limit Controller wiring. Using shielded cables and using separate conduits or ducts is recommended.
When a noise filter is used at the power supply, first check the voltage or current, and attach the noise filter as close as possible to the Limit Controller.
Allow as much space as possible between the Limit Controller and devices that generate powerful high frequencies (high-frequency welders, high-frequency sewing machines, etc.) or surge.
- 8) Use this product within the rated load and power supply.
- 9) Make sure that the rated voltage is attained within two seconds of turning the power ON.
- 10) Make sure the product has 30 minutes or more for warm up.
- 11) A switch or circuit breaker must be provided close to this product. The switch or circuit breaker must be within easy reach of the operator, and must be marked as a disconnecting means for this unit.
- 12) Always turn OFF the power supply before pulling out the interior of the product, and never touch nor apply shock to the terminals or electronic components. When inserting the interior of the product, do not allow the electronic components to touch the case.
- 13) Do not use paint thinner or similar chemical to clean with. Use standard grade alcohol.
- 14) Design the system (e.g., control panel) considering the 2 second of delay that the product's output to be set after power ON.
- 15) The output may turn OFF when shifting to certain levels. Take this into consideration when performing control.

● Service Life

Use the Limit Controller within the following temperature and humidity ranges:

Temperature: –10 to 55°C (with no icing or condensation), Humidity: 25% to 85%

If the Limit Controller is installed inside a control board, the ambient temperature must be kept under 55°C, including the temperature around the Controller.

The service life of electronic devices like Limit Controllers is determined not only by the number of times the relay is switched but also by the service life of internal electronic components. Component service life is affected by the ambient temperature: the higher the temperature, the shorter the service life and, the lower the temperature, the longer the service life. Therefore, the service life can be extended by lowering the temperature of the Limit Controller.

When two or more Limit Controllers or Temperature Controllers are mounted close together horizontally or vertically, the heat generated by the Controllers will cause the Limit Controller's internal temperature to rise and shorten the Controller's service life. In such a case, use forced cooling by fans or other means of air ventilation to cool down the Limit Controllers. When providing forced cooling, however, be careful not to cool down the terminals sections alone to avoid measurement errors.

● Ambient Noise

To avoid inductive noise, keep the wiring for the Limit Controller's terminal block wiring away from power cables carrying high voltages or large currents. Also, do not wire power lines together with or parallel to Limit Controller wiring. Using shielded cables and using separate conduits or ducts is recommended.

Attach a surge suppressor or noise filter to peripheral devices that generate noise (in particular, motors, transformers, solenoids, magnetic coils or other equipment that have an inductance component). When a noise filter is used at the power supply, first check the voltage or current, and attach the noise filter as close as possible to the Limit Controller.

Allow as much space as possible between the Limit Controller and devices that generate powerful high frequencies (high-frequency welders, high-frequency sewing machines, etc.) or surge.

● Ensuring Measurement Accuracy

When extending or connecting the thermocouple lead wire, be sure to use compensating wires that match the thermocouple types.

When extending or connecting the lead wire of the platinum resistance thermometer, be sure to use wires that have low resistance and keep the resistance of the three lead wires the same.

Mount the Limit Controller so that it is horizontally level.

If the measurement accuracy is low, check to see if input shift has been set correctly.

● Waterproofing

The degree of protection is as shown below. Sections without any specification on their degree of protection or those with IP□0 are not waterproof.

Front panel: NEMA4X for indoor use (equivalent to IP66)

Rear case: IP20, Terminal section: IP00

Precautions for Correct Use

- 1) It takes approximately two seconds for the outputs to turn ON from after the power supply is turned ON. This two-second delay must be considered when incorporating Limit Controllers in a sequence circuit.
- 2) Allow at least 30 minutes for warming up.
- 3) Avoid using the Controller in places near a radio, television set, or wireless installing. The Controller may cause radio disturbance for these devices.

Conventions Used in This Manual

Meanings of Abbreviations

The following abbreviations are used in parameter names, figures and in text explanations. These abbreviations mean the following:

Symbol	Term
PV	Process value
SP	Limit setting value
SV	Set value
EU	Engineering unit (See note.)

Note “EU” stands for Engineering Unit. EU is used as the minimum unit for engineering units such as °C, m, and g. The size of EU varies according to the input type.

For example, when the input temperature setting range is –200 to +1300°C, 1 EU is 1°C, and when the input temperature setting range is –20.0 to +500.0°C, 1 EU is 0.1°C.

For analog inputs, the size of EU varies according to the decimal point position of the scaling setting, and 1 EU becomes the minimum scaling unit.

How to Read Display Symbols

The following tables show the correspondence between the symbols displayed on the displays and alphabet characters. The default is for 11-segment displays.

A	b	C	d	E	F	G	H	I	J	K	L	M
A	B	C	D	E	F	G	H	I	J	K	L	M

N	ō	P	Q	R	S	T	U	V	W	X	Y	Z
N	O	P	Q	R	S	T	U	V	W	X	Y	Z

TABLE OF CONTENTS

Preface	v
Visual Aids	v
Read and Understand this Manual	vi
Safety Precautions	viii
Precautions for Safe Use	xi
Precautions for Correct Use	xiii
Conventions Used in This Manual	xiv
How to Read Display Symbols	xv

PART 1: Main Functions

SECTION 1

Introduction

This section introduces the components, features, and main functions of the E5CN-FR Limit Controller. Read this section carefully before using the Limit Controller for the first time.

1.1	Names of Parts	1-2
	Front Panel	1-2
	Meanings of Indicators	1-2
	Using the Keys	1-3
1.2	I/O Configuration and Main Functions	1-4
	I/O Configuration	1-4
	Main Functions	1-5
1.3	Setting Level Configuration and Key Operations	1-7
	Selecting Parameters	1-9
	Fixing Settings	1-9
1.4	Communications Function	1-10

SECTION 2

Preparations

This section describes the steps required before turning ON the power, including settings, installation, and wiring.

2.1	Installation	2-2
	Dimensions	2-2
	Panel Cutout	2-2
	Mounting	2-3
	Removing the E5CN-FR from the Case	2-4
2.2	Wiring Terminals	2-5
	Terminal Arrangement	2-5
	Precautions when Wiring	2-5
	Wiring	2-6

TABLE OF CONTENTS

SECTION 3 Basic Operation

This section provides specific examples to explain the basic operation of the E5CN-FR Limit Controller.

3.1	Initial Setting Examples	3-2
3.2	Setting the Input Type	3-3
	Input Type	3-3
3.3	Selecting the Temperature Unit	3-5
	Temperature Unit	3-5
3.4	Using the Limit Controller Function	3-6
	Selecting Upper/Lower Limit	3-6
	Changing the Limit Setting Value	3-7
	Resetting the Limit Output	3-8
3.5	Alarm Outputs	3-9
	Alarm Types	3-9
	Alarm Values	3-10
	Annunciator	3-12

SECTION 4 Applications Operations

This section describes each function in detail to help make the most of the E5CN-FR Limit Controller's functionality and capabilities.

4.1	Shifting Input Values	4-2
	Shifting Inputs	4-2
	How to Calculate Input Shift Values for a 2-point Shift	4-4
4.2	Alarm Hysteresis	4-7
	Standby Sequence	4-7
	Alarm Latch	4-7
	Close in Alarm/Open in Alarm	4-8
4.3	Using Event Inputs	4-10
	Event Input Functions	4-10
4.4	Monitoring the Limit Over Continuation Time	4-12
	Limit Over Continuation Time	4-12
4.5	Monitoring the Limit Over Minimum/Maximum Value	4-14
	Limit Over Minimum/Maximum Value	4-14
4.6	Setting the Limit Output Operation at Startup	4-15
	Restart Mode	4-15
4.7	Moving to the Advanced Function Setting Level	4-17
4.8	Using the Key Protect Level	4-19
	Protection	4-19
	Entering the Password to Move to the Protect Level	4-20
	Communications Operation Command to Move to the Protect Level	4-22

TABLE OF CONTENTS

4.9	PV Change Color	4-23
	PV Color Change Function	4-23
	Setting	4-23

SECTION 5

Parameters

This section describes the E5CN-FR Limit Controller's parameter settings. Use this section as a reference.

5.1	Conventions Used in this Section	5-2
5.2	Protect Level	5-3
5.3	Operation Level	5-6
5.4	Adjustment Level	5-9
5.5	Initial Setting Level	5-15
5.6	Advanced Function Setting Level	5-21
5.7	Communications Setting Level	5-31

SECTION 6

CALIBRATION

This section explains how to calibrate the Limit Controller.

6.1	Parameter Structure	6-2
6.2	User Calibration	6-4
6.3	Thermocouple Calibration	6-5
6.4	Platinum Resistance Thermometer Calibration	6-8
6.5	Checking Indication Accuracy	6-10

Appendix

Specifications	A-2
Ratings	A-2
Characteristics	A-3
Error Displays	A-4
Parameter Operation Lists	A-6
Sensor Input Setting Range, Indication Range, Control Range	A-11
Setting Levels Diagram	A-13
Parameter Flow	A-14

TABLE OF CONTENTS

PART 2: Communications

SECTION 1

Communications Methods

This section introduces the supported communications methods and device wiring methods. Read and understand this section first in order to wire the devices correctly.

1.1	Overview of Communications Methods	1-2
	Introduction	1-2
	Communications Specifications	1-3
	Transmission Procedure	1-3
	Interface	1-4
	Wiring	1-4
	Communications Parameters	1-5

SECTION 2

CompoWay/F Communications Procedures

Read this section when using CompoWay/F communications to perform operations from a host computer, such as reading/writing variable area data or sending operation commands.

2.1	Data Format	2-2
	Command Frame	2-2
	Response Frame	2-3
	Communications Data	2-4
	End Code Example	2-4
2.2	Structure of Command Text	2-6
	PDU Structure	2-6
	Area Definitions	2-6
	Type Code (Variable Type)	2-7
	Addresses	2-7
	Number of Elements	2-7
	List of Services	2-8
2.3	Detailed Description of the Services	2-9
	Read Variable Area	2-9
	Write Variable Area	2-10
	Read Controller Attributes	2-12
	Read Controller Status	2-13
	Echoback Test	2-14
	Operation Command	2-15
2.4	Response Code List	2-18

TABLE OF CONTENTS

SECTION 3

Communications Data for CompoWay/F

This section shows the communications data format used in CompoWay/F communications. Refer to this section when reading or setting data via CompoWay/F communications.

3.1	Variable Area (Setting Range) List	3-2
3.2	Status	3-7

SECTION 4

Modbus Communications Procedure

Read this section when using Modbus communications to perform operations from a host computer, such as reading/writing variable area data or sending operation commands.

4.1	Data Format	4-2
	Command Frame	4-2
	Response Frame	4-4
	Error Codes	4-5
4.2	Function List	4-6
4.3	Variable Area	4-7
4.4	Detailed Description of the Services	4-9
	Read Variable Area	4-9
	Write Variable Area	4-11
	Operation Commands	4-14
	Echoback Test	4-17

SECTION 5

Communications Data for Modbus

This section shows the communications data format used in Modbus communications. Refer to this section when reading or setting data via Modbus communications.

5.1	Variable Area (Setting Range) List	5-2
5.2	Status	5-7

Appendix

	ASCII List	A-2
	Index	I-1
	Revision History	R-1

About this Manual:

This manual describes the E5CN-FR Limit Controller and includes the sections described below. Please read this manual carefully and be sure you understand the information provided before attempting to set up or operate an E5CN-FR Limit Controller.

PART 1: Main Functions

• Overview

Section 1 introduces the features, components, and main specifications of the E5CN-FR Limit Controller.

• Setup

Section 2 describes the steps required to prepare the E5CN-FR Limit Controller for operation, including installation and wiring.

• Basic Operations

Sections 3 and 5 describes the basic operation of the E5CN-FR Limit Controller, including key operations to set parameters and descriptions of display elements based on specific control examples.

• Operations for Applications

Sections 4 and 5 describes the special functions (such as input value adjustment and event inputs) that can be used to make the most of the functionality of the E5CN-FR Limit Controller.

• User Calibration

Section 6 describes how the user can calibrate the E5CN-FR Limit Controller.

• Appendices

The *Appendices* provides information for easy reference, including lists of parameters and settings.

PART 2: Communications

Descriptions in this manual are separated by the communications method. Read the sections that are application to the system being used.

• Overview

Section 1 introduces the communications measures that can be used.

• CompoWay/F

Sections 2 and 3 describes the CompoWay/F communications and the data format that is required.

• Modbus

Sections 4 and 5 describes the Modbus communications and the data format that is required.

• Appendix

The *Appendix* provides a list of ASCII data.

 **WARNING** Failure to read and understand the information provided in this manual may result in personal injury or death, damage to the product, or product failure. Please read each section in its entirety and be sure you understand the information provided in the section and related sections before attempting any of the procedures or operations given.



PART 1: Main Functions

SECTION 1

Introduction

This section introduces the components, features, and main functions of the E5CN-FR Limit Controller. Read this section carefully before using the Limit Controller for the first time.

1.1	Names of Parts	1-2
	Front Panel	1-2
	Meanings of Indicators	1-2
	Using the Keys	1-3
1.2	I/O Configuration and Main Functions	1-4
	I/O Configuration	1-4
	Main Functions	1-5
1.3	Setting Level Configuration and Key Operations	1-7
	Selecting Parameters	1-9
	Fixing Settings	1-9
1.4	Communications Function	1-10

1.1 Names of Parts

■ Front Panel

The front panel is the same for the E5CN-FR.

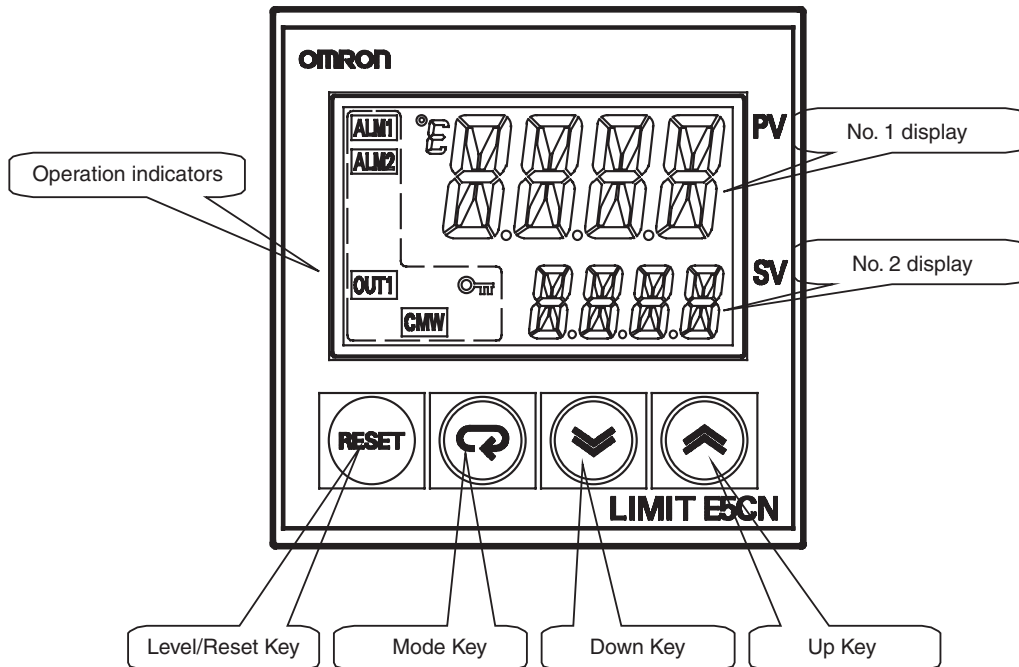

■ Meanings of Indicators



● No. 1 Display

Displays the process value or parameter type.
Lights for approximately one second during startup.

● No. 2 Display

Displays the limit setting value, parameter operation read value, or the variable input value.
Lights for approximately one second during startup.

● Operation Indicators

1. ALM1 (Alarm 1)
Lights when the alarm 1 output is ON.
ALM2 (Alarm 2)
Lights when the alarm 2 output is ON.
2. OUT1 (Limit output)
Lights when the limit output is OFF.
3. CMW (Communications Writing)
Lights when communications writing is enabled and is out when it is disabled.
4.  (Key)
Lights when settings change protect is ON (i.e., when the  and  keys are disabled by protected status.

● Temperature Unit

The temperature unit is displayed when parameters are set to display a temperature. The display is determined by the currently selected “temperature unit” parameter set value. °C indicates °C and °F indicates °F.

■ Using the Keys

This section describes the basic functions of the front panel keys.

● (Level)/Reset Key

Press this key to move between setting levels. The setting level is selected in the following order: operation level: adjustment level, initial setting level, communications setting level.

Can be used to reset the limit output.

● (Mode) Key

Press this key to change parameters within a setting level.

The parameters can be reversed by holding down the key (moving one per second in reverse order).

● (Up) Key

Each press of this key increments the value displayed on the No. 2 display or advances the setting. Holding the key down speeds up the incrementation.



● (Down) Key

Each press of this key decrements values displayed on the No. 2 display or reverses the setting. Holding the key down speeds up the incrementation.

● + Keys

Press these keys to change to the protect level. For details on operations involving holding these keys down simultaneously, refer to *1.3 Setting Level Configuration and Key Operations*. For details on the protect level, refer to *SECTION 5 Parameters*.

● + Keys + Keys

To restrict set value changes (in order to prevent accidental or incorrect operations), these key operations require simultaneously pressing the  key along with  or  key. This applies only to the parameter for the password to move to protect level. (Refer to page 5-5.)

1.2 I/O Configuration and Main Functions

■ I/O Configuration

● E5CN-FR

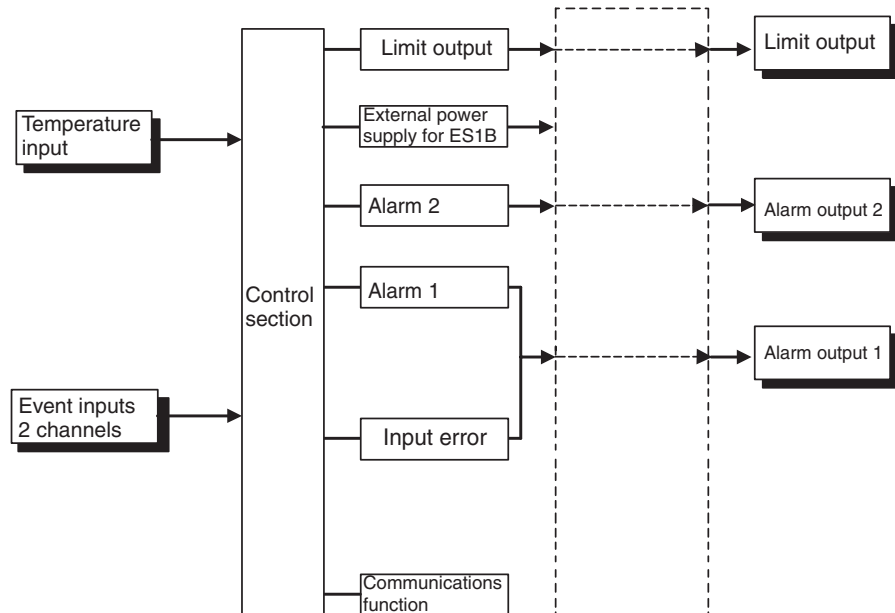

● Standard Models

Model number	Specifications
E5CN-FR2MT	100 to 240 VAC, thermocouple or platinum resistance thermometer input, 2 alarm outputs, 1 limit output (Base model: E5CN-R2MT-500)
E5CN-FRMT	100 to 240 VAC, thermocouple or platinum resistance thermometer input, 1 limit output (Base model: E5CN-RMT-500)

● Compatible Option Units

Model number	Specifications
E53-CNBN	Two event inputs
E53-CN03N	RS-485 communications interface
E53-CNPBN	Two event inputs and external power supply for ES1B

■ Main Functions

This section introduces the main E5CN-FR functions. For details on particular functions and how to use them, refer to *SECTION 3 Basic Operation* and following sections.

● Limit Control Function (Limit Output)

When a Temperature Controller is controlling the temperature of a furnace or other heating device, a malfunction in the Temperature Controller may cause the furnace temperature to rise, resulting in damage to the heated product or the furnace itself.

When this situation occurs with the Limit Controller and the temperature rises above the preset limit temperature (limit setting value), the limit output will go OFF and the heater system circuit can be shut down to stop the heat source. In addition, the limit output will remain OFF even when the temperature returns to the normal range. A safer system can be constructed because the limit output will remain OFF until it is reset manually.

With the E5CN-FR Limit Controllers, it is possible to establish a lower limit instead of an upper limit so that the limit function operates when the temperature falls below the limit setting value.

● Input Sensor Types

- The following input sensors can be connected for temperature input:

Thermocouple: K, J, T, E, L, U, N, R, S, B

Infrared Thermosensor: ES1B

10 to 70°C, 60 to 120°C, 115 to 165°C,

140 to 260°C

Platinum resistance thermometer: Pt100, JPt100

● Alarms

- Alarms can be used with the E5CN-FR2□□. Set the alarm classification and alarm value or the alarm's upper and lower limits.
- If necessary, a more comprehensive alarm function can be achieved by setting the standby sequence, alarm hysteresis, close in alarm/open in alarm, and alarm latch parameters.
- When the "input error output" parameter is set to ON, the alarm 1 output turns ON when an input error occurs.

● Event Inputs

- With the E5CN-FR□□B, the limit output can be cleared by an event input.

● Communications Functions

- With the E5CN-FR□□03, communications functions utilizing CompoWay/F (see note 1) or Modbus (see note 2) can be used.

Note 1. CompoWay/F is an integrated general-purpose serial communications protocol developed by OMRON. It uses commands compliant with the well-established FINS, together with a consistent frame format on OMRON Programmable Controllers to facilitate communications between personal computers and components.

Note 2. Modbus is a communications control method conforming to the RTU Mode of Modicon Inc.'s Modbus Protocol.

● External Power Supply for ES1B

- The E5CN-FR□□P can be used as the power supply for an ES1B Infrared Thermosensor.

1.3 Setting Level Configuration and Key Operations

Parameters are divided into groups, each called a “level.” Each of the set values (setting items) in these levels is called a “parameter.” The parameters on the E5CN-FR Limit Controller are divided into the following seven levels. When the power is turned ON, all of the display lights for approximately one second.

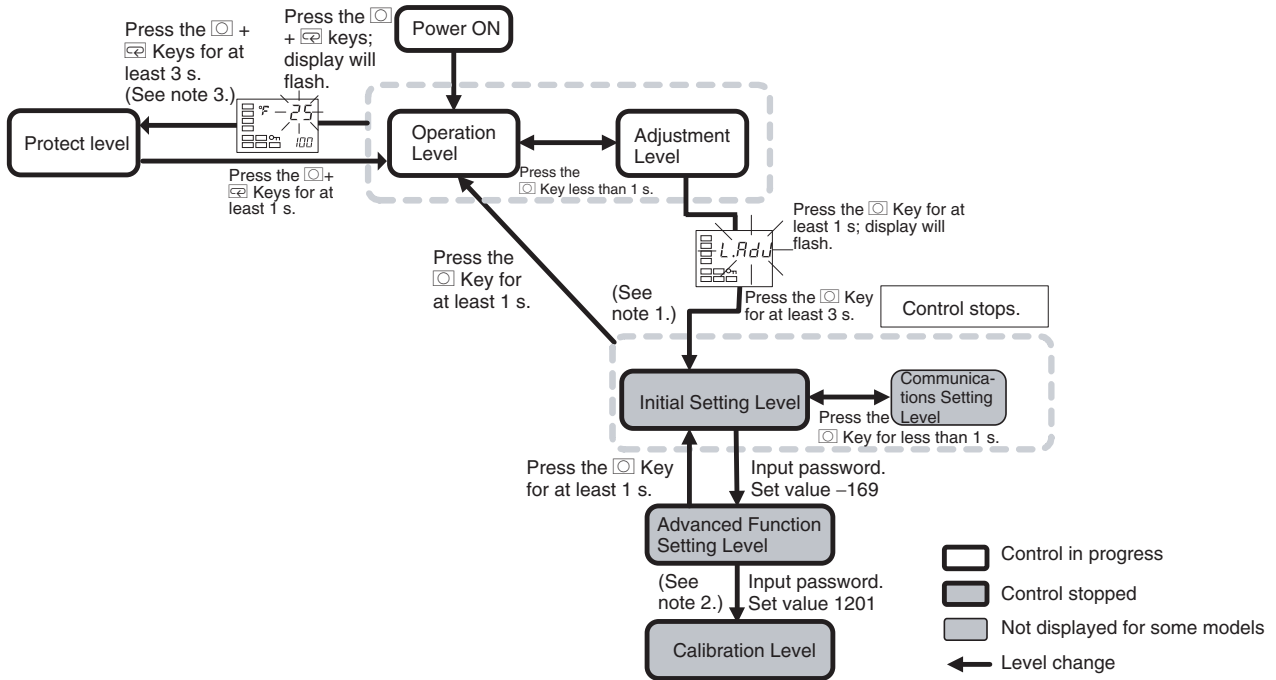



- Note 1. Operation level entered for software reset.
- Note 2. You cannot move to other levels by operating the keys on the front panel from the calibration level. You must turn OFF the power supply.
- Note 3. The time taken to move to the protect level can be adjusted by changing the “Move to protect level time” setting.

Level	Control in progress	Control stopped
Protect level	Can be set.	---
Operation level	Can be set.	---
Adjustment level	Can be set.	---
Initial setting level	---	Can be set.
Advanced function setting level	---	Can be set.
Calibration level	---	Can be set.
Communications setting level	---	Can be set.

Of these levels, the initial setting level, communications setting level, advanced function setting level, and calibration level can be used only when operation is stopped. Operation is stopped when any of these four levels is selected.

● Protect Level

- To switch from the operation level to the protect level, simultaneously hold down the  and  keys for at least 3 seconds. This level is for preventing unwanted or accidental modification of parameters. Protected levels will not be displayed, and so the parameters in that level cannot be modified.



● Operation Level

- The operation level is displayed when the power is turned ON. You can switch from the operation level to either the protect level or adjustment level.
- Normally, select this level during operation. While operation is in progress, items such as the PV and limit setting value can be monitored.

● Adjustment Level

- To move to the adjustment level, press the  key once (for less than 1 s).
- This level is for entering the limit setting value and shift values. Other settings can be made as well, such as enabling/disabling write operations via communications, hysteresis settings, and input shift parameters. From the adjustment level, it is possible to move to the top parameter of the initial setting level or operation level.

● Initial Setting Level

- To move to the initial setting level from the adjustment level, press the  key for at least 3 seconds. The No. 1 display flashes after one second. This level is used to specify the temperature input type and set the alarm type. You can move to the advanced function setting level or communications setting level from this level. To return to the operation level, press the  key for at least one second. To move to the communications setting level, press the  key for less than one second.

(When moving from the initial setting level to the operation level, all the indicators will light.)

● Advanced Function Setting Level

- To move to the advanced function setting level, set the “initial setting/communications protect” parameter in the protect level to 0 and then, in the initial setting level, input the password (-169).
- From the advanced function setting level, it is possible to move to the calibration level or to the initial setting level.
- This level is for setting the display auto-return time, event input assignments, standby sequence, and alarm hysteresis, and it is the level for moving to the user calibration.

● Communications Setting Level

- To move to the communications setting level from the initial setting level, press the  key once (for less than 1 s). When using the communications function, set the communications conditions in this level. Communications can be established with a host computer (personal computer) in order to read/write the limit setting value or monitor the PV from the computer.

● Calibration Level





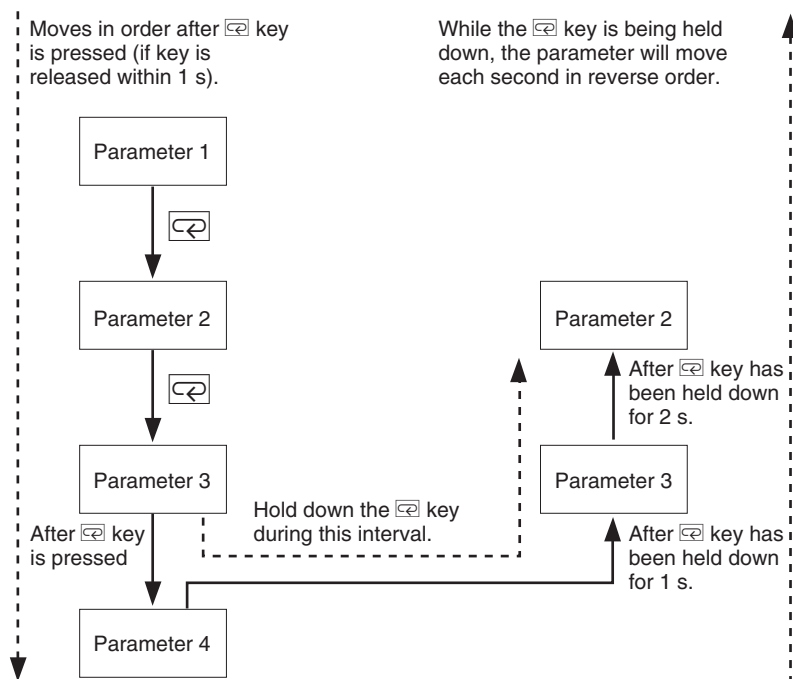

- To move to the calibration level, input the password (1201) from the advanced setting level. The calibration level is for offsetting error in the input circuit.
- You cannot move to other levels from the calibration level by operating the keys on the front panel. To cancel this level, turn the power OFF then back ON again.

■ Selecting Parameters

- Within each level, the parameter is changed in order (or in reverse order) each time the  key is pressed. (In the calibration level, however, parameters cannot be changed in reverse order.) For details, refer to *SECTION 5 Parameters*.







■ Fixing Settings

- If you press the  key at the final parameter, the display returns to the top parameter for the current level.
- To change parameter settings, specify the setting using the  or  key, and either leave the setting for at least two seconds or press the  key. This fixes the setting.
- When another level is selected after a setting has been changed, the contents of the parameter prior to the change are fixed.
- When you turn the power OFF, you must first fix the settings (by pressing the  key). The settings are sometimes not changed by merely pressing the  or  keys.

1.4 Communications Function

The E5CN-FR is provided with a communications function that enables parameters to be checked and set from a host computer. If the communications function is required, use a model that has that function (E5CN-FR□□03). For details on the communications functions, see the Part 2: *Communications*. Use the following procedure to move to the communications setting level.

1. Press the  key for at least three seconds to move from the adjustment level to the initial setting level.
2. Press the  key for less than one second to move from the initial setting level to the communications setting level.
3. Select the parameters as shown below by pressing the  key.
4. Press the  or  key to change the parameter setting.

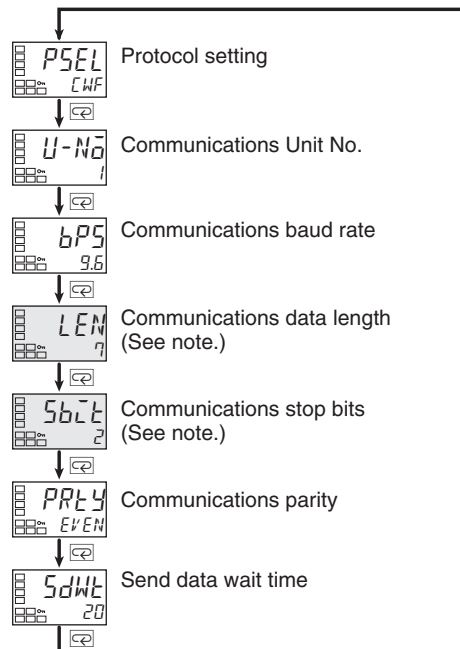

Note: The "protocol setting" parameter is displayed only when CompoWay/F communications are being used.

● Setting Communications Data

Match the communications specifications of the E5CN-FR and the host computer. If a 1:N connection is being used, ensure that the communications specifications for all devices in the system (except the communications Unit No.) are the same.

Parameter	Symbol	Setting (monitor) value	Selection symbols	Default	Unit
Protocol setting	<i>PSEL</i>	CompoWay/F (SYSWAY), Modbus	<i>WF, Mod</i>	CompoWay/ F (SYSWAY)	None
Communications Unit No.	<i>U-NO</i>	0 to 99		1	None
Communications baud rate	<i>BPS</i>	1.2, 2.4, 4.8, 9.6, 19.2, 38.4	<i>1.2, 2.4, 4.8, 9.6, 19.2, 38.4</i>	9.6	kbit/s
Communications data length	<i>LEN</i>	7, 8		7	Bits
Communications stop bits	<i>SBIT</i>	1, 2		2	Bits
Communications parity	<i>PRTY</i>	None, Even, Odd	<i>NONE, EVEN, odd</i>	Even	None
Send data wait time	<i>SDWE</i>	0 to 99		20	ms

SECTION 2

Preparations

This section describes the steps required before turning ON the power, including settings, installation, and wiring.

2.1	Installation	2-2
	Dimensions.....	2-2
	Panel Cutout.....	2-2
	Mounting.....	2-3
	Removing the E5CN-FR from the Case	2-4
2.2	Wiring Terminals.....	2-5
	Terminal Arrangement.....	2-5
	Precautions when Wiring.....	2-5
	Wiring	2-6

2.1 Installation

■ Dimensions

(Unit: mm)

● E5CN-FR

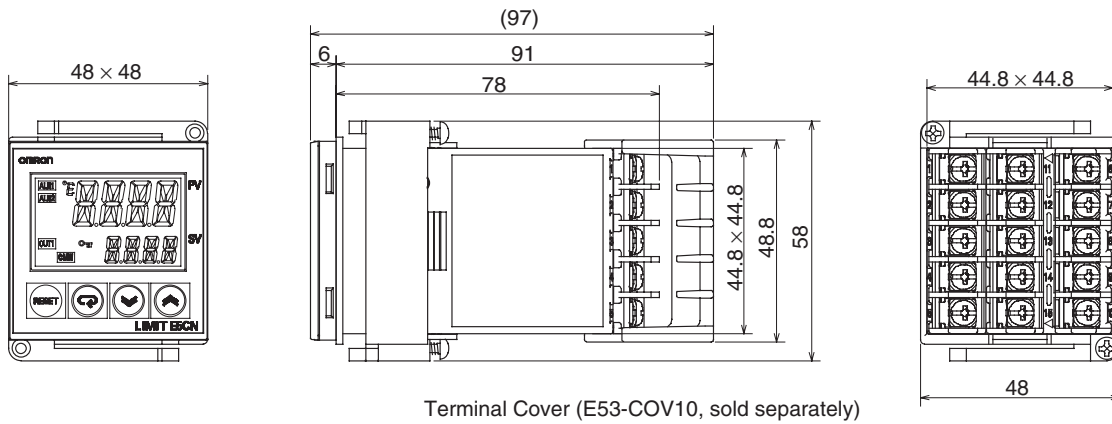

■ Panel Cutout

(Unit: mm)

Individual Mounting

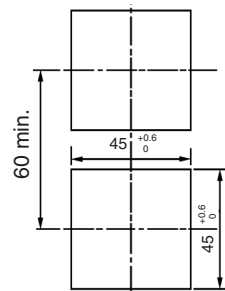

Group Mounting

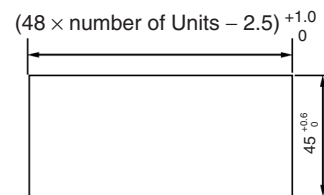

- Waterproofing is not possible when group mounting several Controllers.
- The recommended panel thickness is 1 to 5 mm.
- Units must not be closely mounted vertically. (Observe the recommended mounting space limits.)
- When group mounting several Controllers, ensure that the surrounding temperature does not exceed the ambient operating temperature listed in the specifications.

■ Mounting

For the Wiring Socket, purchase the P2CF-11 or PG3A-11 separately.

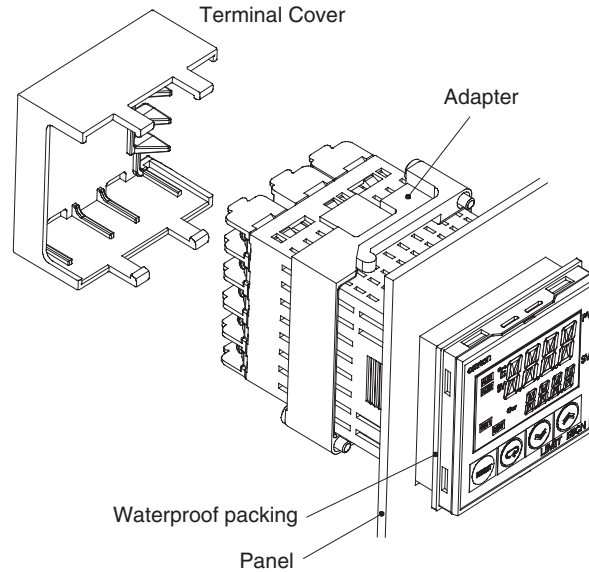

● Mounting to the Panel

1. For waterproof mounting, waterproof packing must be installed on the Controller. Waterproofing is not possible when group mounting several Controllers.
2. Insert the E5CN-FR into the mounting hole in the panel.
3. Push the adapter from the terminals up to the panel, and temporarily fasten the E5CN-FR.
4. Tighten the two fastening screws on the adapter. Alternately tighten the two screws little by little to maintain a balance. Tighten the screws to a torque of 0.29 to 0.39 N·m.

● Mounting the Terminal Cover

For the E5CN-FR, be sure that the "UP" mark is facing up, and then fit the terminal cover into the holes on the top and bottom.

■ Removing the E5CN-FR from the Case

The E5CN-FR can be removed from the case to perform maintenance without removing the terminal leads.

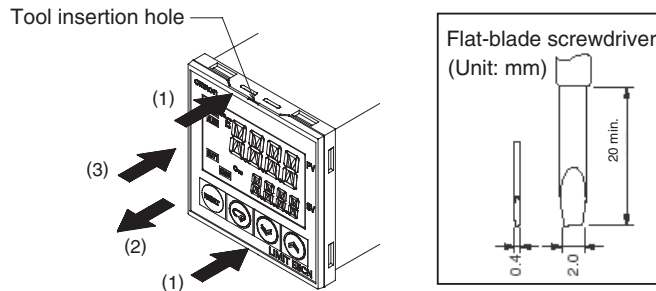

1. Insert the tool into the two tool insertion holes (one on the top and one on the bottom) and release the hooks.
2. Insert the tool in the gap between the front panel and rear case, and pull out the front panel slightly. Hold the top and bottom of the front panel and carefully pull it out toward you, without applying unnecessary force.
3. When inserting the E5CN-FR, check to make sure that the waterproof packing is in place and push the E5CN-FR toward the rear case until it snaps into position. While pushing the E5CN-FR into place, push down on the hooks on the top and bottom surfaces of the rear case so that the hooks are securely locked in place. Be sure that electronic components do not come into contact with the case.

2.2 Wiring Terminals

Terminal Arrangement

● E5CN-FR

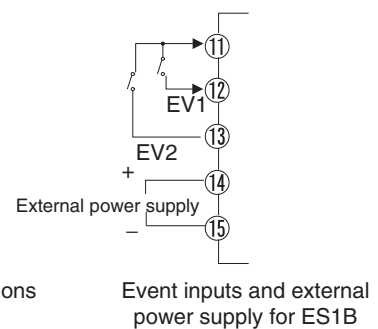
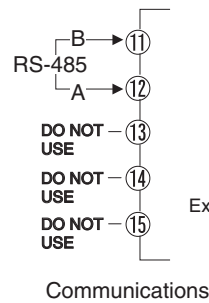
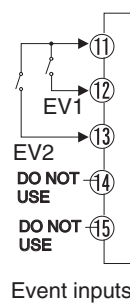
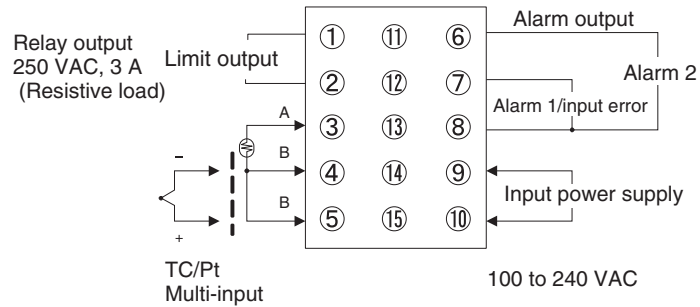

Precautions when Wiring

- Separate input leads and power lines in order to prevent external noise.
- Use AWG24 (cross-sectional area: 0.205 mm²) to AWG14 (cross-sectional area: 2.081 mm²) twisted-pair cable (stripping length: 5 to 6 mm).
- Use crimp terminals when wiring the terminals.
- Tighten the terminal screws to a torque of 0.74 to 0.90 N·m.
- Use the following types of crimp terminals for M3.5 screws.



- Do not remove the terminal block. Doing so may result in failure or malfunction.

■ Wiring

In the connection diagrams, the left side of the terminal numbers represents the inside of the Controller and the right side represents the outside.

● Power supply

- With the E5CN-FR, connect the power supply to terminals 9 and 10. The following table shows the specifications.

Input power supply	E5CN-FR
100 to 240 VAC, 50/60 Hz	7.5 VA

- Standard insulation is applied to the power supply I/O sections. If reinforced insulation is required, connect the input and output terminals to a device without any exposed current-carrying parts or to a device with standard insulation suitable for the maximum operating voltage of the power supply I/O section.

● Input

- Connect the temperature input using terminals 3 to 5 for the E5CN-FR, using the appropriate terminals for the input type being used.

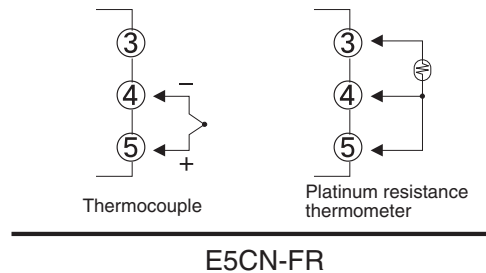

● Limit Output

- The limit output is output at terminals 1 and 2.

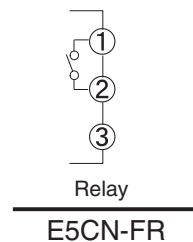

- The following table shows the specifications for each output type.

Specifications
250 VAC, 3A (resistive load), electrical durability: 100,000 operations

● Alarm 1 and 2 Outputs

- On the E5CN-FR□□□, the alarm 1 output (ALM1) is output across terminals 7 and 8, and the alarm 2 output (ALM2) is output across terminals 6 and 8.
- When the “input error output” parameter is set to ON, the alarm 1 output turns ON when an input error occurs.
- The following diagrams show the internal equalizing circuits for the alarm 1 and 2 outputs.

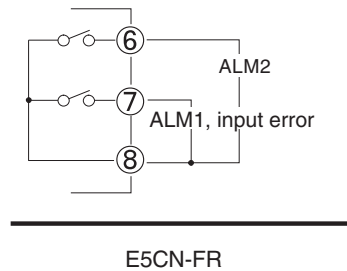

- The relay specifications are as follows:
SPST-NO 250 VAC 1 A

● Event Inputs

- When event inputs are to be used with the E5CN-FR□□B, connect to terminals 11 to 13.

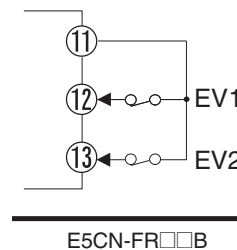

- Use event inputs under the following conditions:
- The outflow current is approximately 7 mA.

Contact input	ON: 1 kΩ max., OFF: 100 kΩ min.
No-contact input	ON: Residual voltage 1.5 V max.; OFF: Leakage current 0.1 mA max.

Polarities during no-contact input are as follows:

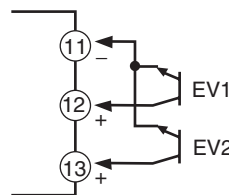

● Communications

- When communications are to be used with the E5CN-FR□□03, connect communications cable across terminals 11 and 12.

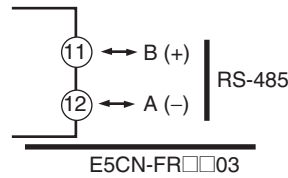

Specify both ends of the transmission path including the host computer as end nodes (that is, connect terminators to both ends).

The minimum terminal resistance is 54 Ω.

Communications Unit Connection Diagram

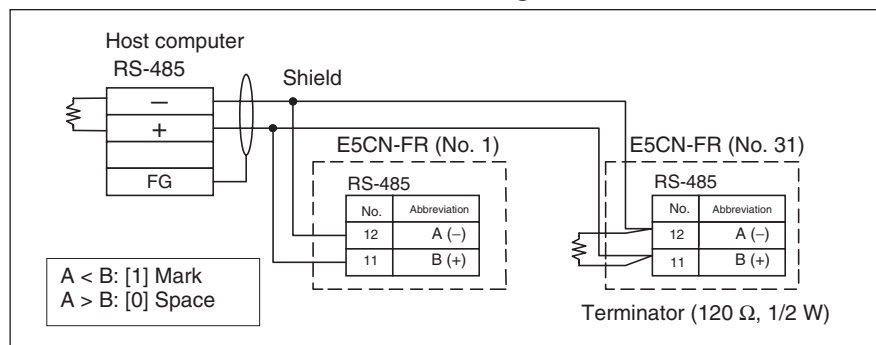

- The RS-485 connection can be either one-to-one or one-to-N. A maximum of 32 Units (including the host computer) can be connected in one-to-N systems. The maximum total cable length is 500 m. Use AWG24 (cross-sectional area: 0.205 mm²) to AWG14 (cross-sectional area: 2.081 mm²) shielded twisted-pair cable.

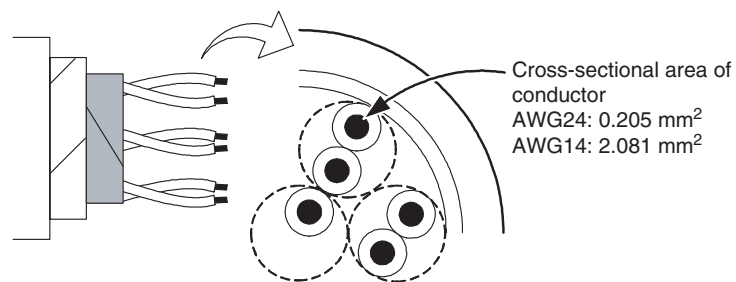

● External Power Supply for ES1B

- Connect terminals 14 and 15 when using the E5CN-FR□□PB as the external power supply for the ES1B.

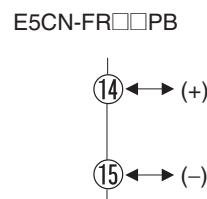

- The following table provides the specifications of the external power supply for ES1B.

Output voltage	12 VDC \pm 10%
Output current	20 mA max.

- Contact your OMRON representative for information on using the external power supply for ES1B for other applications.



SECTION 3

Basic Operation

This section provides specific examples to explain the basic operation of the E5CN-FR Limit Controller.

3.1	Initial Setting Examples	3-2
3.2	Setting the Input Type	3-3
	Input Type.....	3-3
3.3	Selecting the Temperature Unit	3-5
	Temperature Unit.....	3-5
3.4	Using the Limit Controller Function.....	3-6
	Selecting Upper/Lower Limit.....	3-6
	Changing the Limit Setting Value	3-7
	Resetting the Limit Output	3-8
3.5	Alarm Outputs.....	3-9
	Alarm Types	3-9
	Alarm Values	3-10
	Annunciator	3-12



3.1 Initial Setting Examples

The initial hardware setup, including the sensor input type, alarm types, and other settings are made with the parameter displays. The  and  keys are used to switch between parameters, and the amount of time that you press the keys determines which parameter you move to. This section describes a typical application example.

● Explanation of Examples

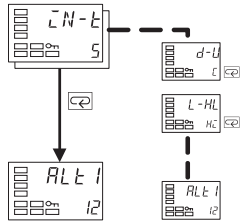

Changing Parameters

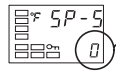

A  image means that there are parameters. Continue pressing the  key to change parameters until you reach the intended parameter.

Changing Numbers



Numeric data and selections in each screen can be changed by using the  and  keys.

● Typical Example

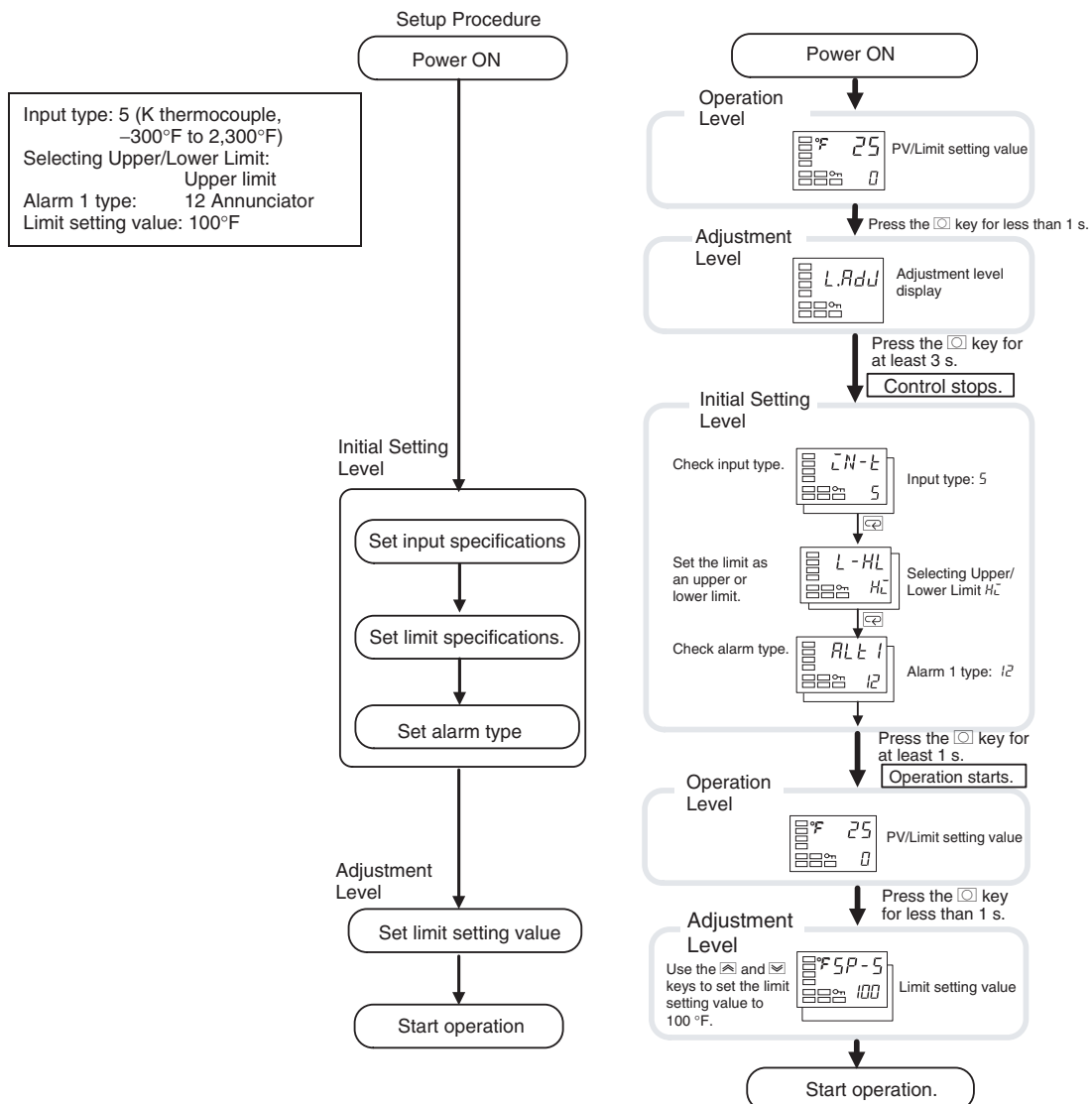

3.2 Setting the Input Type

The Controller supports three input types: platinum resistance thermometer, thermocouple, and infrared thermosensor inputs. Set the input type that matches the sensor that is used.

■ Input Type

The following example shows how to set a K thermocouple for 0.0 to 900.0°F.

● Operating Procedure

Operation Level

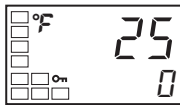

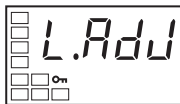

Adjustment Level

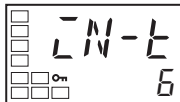
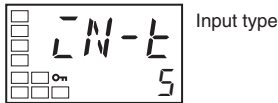

Initial Setting Level





1. Press the  key to move from the operation level to the adjustment level.

2. Press the  key for at least three seconds to move from the adjustment level to the initial setting level.

3. Press the  key to enter the set value of the desired sensor.

When you use a K thermocouple (0.0 to 900.0°F), enter 6 as the set value.

Hint: The key operation is fixed two seconds after the change, or by pressing the  or  key.

List of Input Types

Input type	Specifications	Set value	Input temperature setting range
Platinum resistance thermometer	Pt100	0	-200 to 850 (°C)/-300 to 1,500 (°F)
		1	-199.9 to 500.0 (°C)/-199.9 to 900.0 (°F)
		2	0.0 to 100.0 (°C)/0.0 to 210.0 (°F)
	JPt100	3	-199.9 to 500.0 (°C)/-199.9 to 900.0 (°F)
4		0.0 to 100.0 (°C)/0.0 to 210.0 (°F)	

Input type	Specifications	Set value	Input temperature setting range
Thermocouple	K	5	-200 to 1,300 (°C)/-300 to 2,300 (°F)
		6	-20.0 to 500.0 (°C)/0.0 to 900.0 (°F)
	J	7	-100 to 850 (°C)/-100 to 1,500 (°F)
		8	-20.0 to 400.0 (°C)/0.0 to 750.0 (°F)
	T	9	-200 to 400 (°C)/-300 to 700 (°F)
		10	-199.9 to 400.0 (°C)/-199.9 to 700.0 (°F)
	E	11	0 to 600 (°C)/0 to 1,100 (°F)
	L	12	-100 to 850 (°C)/-100 to 1,500 (°F)
	U	13	-200 to 400 (°C)/-300 to 700 (°F)
		14	-199.9 to 400.0 (°C)/-199.9 to 700.0 (°F)
	N	15	-200 to 1,300 (°C)/-300 to 2,300 (°F)
	R	16	0 to 1,700 (°C)/0 to 3,000 (°F)
	S	17	0 to 1,700 (°C)/0 to 3,000 (°F)
B	18	100 to 1,800 (°C)/300 to 3,200 (°F)	
ES1B Infrared Temperature Sensor	10 to 70°C	19	0 to 90 (°C)/0 to 190 (°F)
	60 to 120°C	20	0 to 120 (°C)/0 to 240 (°F)
	115 to 165°C	21	0 to 165 (°C)/0 to 320 (°F)
	140 to 260°C	22	0 to 260 (°C)/0 to 500 (°F)

- The default is 5.
- If a platinum resistance thermometer is mistakenly connected while a setting for other than a platinum resistance thermometer is in effect, *S.ERR* will be displayed. To clear the *S.ERR* display, check the wiring and then turn the power OFF and back ON.

3.3 Selecting the Temperature Unit

■ Temperature Unit

- Either °C or °F can be selected as the temperature unit.
- Set the temperature unit in the “temperature unit” parameter of the initial setting level. The default is °F (°F).

● Operating Procedure

The following example shows how to select °C as the temperature unit.

Operation Level

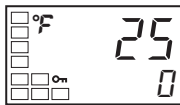

Adjustment Level

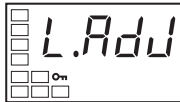

Initial Setting Level

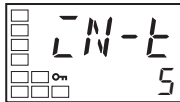

Initial Setting Level

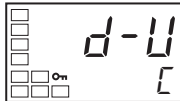

Temperature unit

1. Press the key to move from the operation level to the adjustment level.
2. Press the key for at least three seconds to move from the adjustment level to the initial setting level.
3. Select the “temperature unit” parameter by pressing the key.
Press the or key to select either °C or °F.
°C: °C
°F: °F
4. To return to the operation level, press the key for at least one second.

3.4 Using the Limit Controller Function

When the measured temperature (PV) exceeds the limit setting value, the limit output relay turns OFF and the OUT1 operation indicator turns ON. If the limit output relay turns OFF (limit alarm is ON), the limit output relay will remain OFF until the operator checks operation (performs resetting operation).

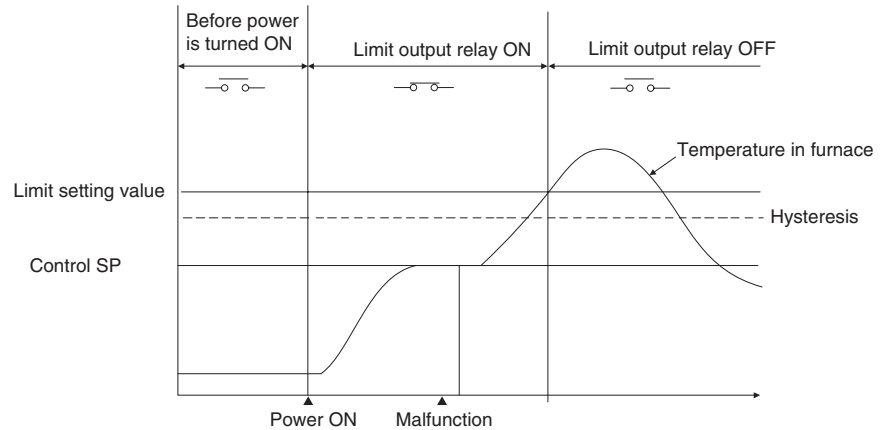

■ Selecting Upper/Lower Limit

- The upper/lower limit selection setting enables switching between upper limit and lower limit operation.
- The default setting is for upper limit operation (high limit).

● Operating Procedure

The following example shows how to select either upper or lower limit operation.

Operation Level

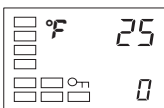

Adjustment Level

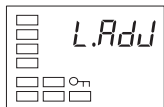

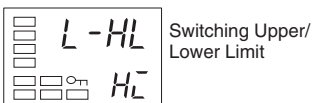
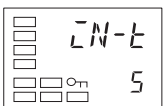

Initial Setting Level



Switching Upper/
Lower Limit

1. Press the key to move from the operation level to the adjustment level.
2. Press the key for at least three seconds to move from the adjustment level to the initial setting level.
3. Press key to select the Selecting Upper/Lower Limit setting.
4. Press the or key to select either upper (HL) or lower (HL) limit operation.
5. To return to the operation level, press the key for at least one second.

■ Changing the Limit Setting Value

- The operation level is displayed when the power is turned ON. The PV is shown on the No. 1 display and the limit setting value is shown in the bottom part of the display, but the limit setting value can only be monitored in the operation level. The limit setting value can be changed on the adjustment level's Limit Setting Value display.
- It is not possible to switch to the adjustment level unless the "operation/adjustment protect" parameter is set to 0, so this parameter must be set to 0 in order to change the limit setting value. For details, refer to 4.8 *Using the Key Protect Level*.
- To change the limit setting value, press the  or  key in the "limit setting value" parameter (in the adjustment level), and set the desired set value. The new limit setting value will become effective two seconds after you have specified the new value.

● Operating Procedure

In this example, the limit setting value is changed from 0°F to 200°F. Normally, the "process value/limit setting value" parameter is displayed. The limit setting value is 0°F.

Operation Level

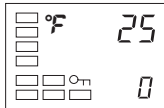

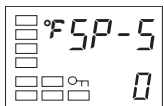
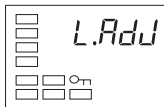

Adjustment Level



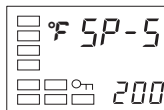

Limit setting value



1. Press the  key to move from the operation level to the adjustment level.

2. Press the  key to select the "limit setting value" parameter.

3. Use the  and  keys to set the limit setting value to 200°F.

Resetting the Limit Output

- When the Controller is in the operation level, the limit output can be reset by pressing the Level/Reset Key for more than one second.
- The limit output reset operation resets the limit output and also resets the annunciator alarm.

Note 1. If the limit status is OFF, the limit output will be reset and the limit output relay will go ON.

If the limit status is still ON (i.e., if the PV still exceeds the limit setting value), the limit output will not be reset.

Note 2. The annunciator alarm will be turned OFF regardless of the limit status.

Note 3. When the limit output is being reset with an event input, the event input can be received in the operation level, adjustment level, or protect level.

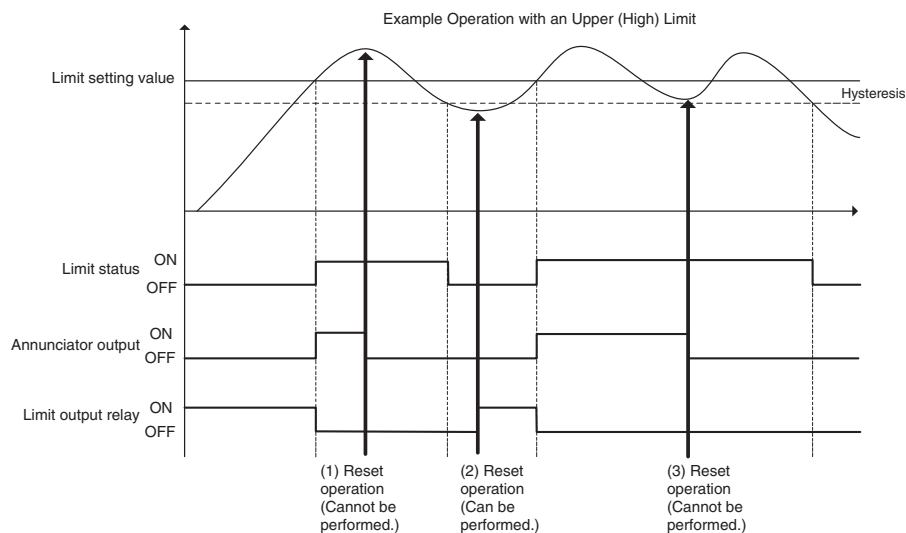

Operating Procedure

The following example shows how to clear the limit output.

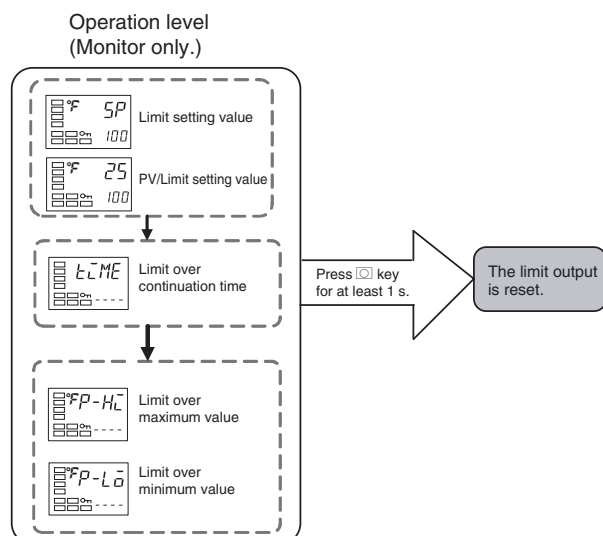

3.5 Alarm Outputs

- The alarm can be used in the E5CN-FR2□□□ (equipped with 2 alarms).

Alarm outputs are determined by a combination of “alarm type,” “alarm value,” and “alarm hysteresis” alarm output conditions. For details, refer to 4.2 *Alarm Hysteresis*.

- This section describes the “alarm type,” “alarm value,” “upper-limit alarm” and “lower-limit alarm” parameters.

■ Alarm Types

Set value	Alarm type	Alarm output operation	
		When alarm value X is positive	When alarm value X is negative
0	Alarm function OFF	Output OFF	
1 (See note 1.)	Upper- and lower-limit (deviation)		See note 2.
2	Upper-limit (deviation)		
3	Lower-limit (deviation)		
4 (See note 1.)	Upper- and lower-limit range (deviation)		See note 3.
5 (See note 1.)	Upper- and lower-limit with standby sequence (deviation)	 See note 5.	See note 4.
6	Upper-limit with standby sequence (deviation)		
7	Lower-limit with standby sequence (deviation)		
8	Absolute-value upper-limit		
9	Absolute-value lower-limit		
10	Absolute-value upper-limit with standby sequence		
11	Absolute-value lower-limit with standby sequence		

Set value	Alarm type	Alarm output operation	
		When alarm value X is positive	When alarm value X is negative
12	Annunciator	---	---

Note 1. With set values 1, 4, and 5, the upper- and lower-limit values can be set independently for each alarm type, and are expressed as “L” and “H.”

Note 2. Set value: 1 (Upper- and lower-limit alarm)

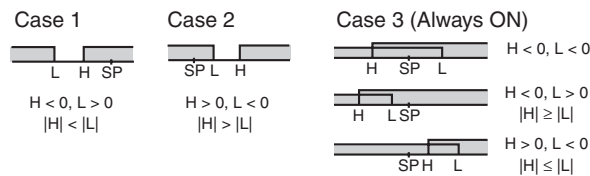

Note 3. Set value: 4 (Upper- and lower-limit range)

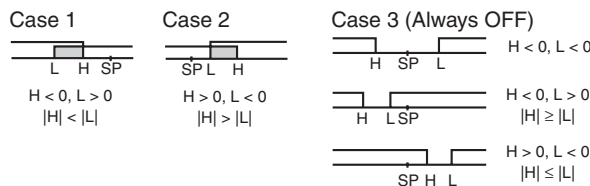

Note 4. Set value: 5 (Upper- and lower-limit with standby sequence)

- For the lower-limit alarms in cases 1 and 2 above, the alarm is always OFF if upper- and lower-limit hysteresis overlaps.
- In case 3, the alarm is always OFF.

Note 5. Set value: 5 (Upper- and lower-limit with standby sequence)

- The alarm is always OFF if upper- and lower-limit hysteresis overlaps.
- Set the alarm type independently for each alarm in the “alarm 1 and 2 type” parameters in the initial setting level. The default settings are Alarm 1 Type = 12 (annunciator alarm) and Alarm 2 Type = 2 (upper limit alarm).

Alarm Values

AL 1L Alarm lower limit value

AL 2L

AL 1H Alarm upper limit value

AL 2H

AL - 1 Alarm value

AL - 2

- Alarm values are indicated by “X” in the table on the previous page. When the upper and lower limits are set independently, “H” is displayed for upper limit values, and “L” is displayed for lower limit values.
- To set the alarm value upper and lower limits for deviation, switch to the adjustment level, set the upper limits in the “alarm value upper limit 1 and 2” parameters, and set the lower limits in the “alarm value lower limit 1 and 2” parameters.

● Operating Procedure

This procedure sets alarm 1 as an upper-limit alarm. The related parameters and settings are shown below. The alarm is output when the limit setting value is exceeded by 10°F. (In this example, the temperature unit is °F.)

Alarm 1 type = 2 (Upper-limit alarm)

Alarm value 1 = 10

Operation Level

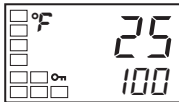

Adjustment Level

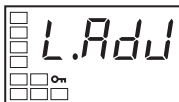

Initial Setting Level

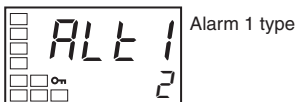
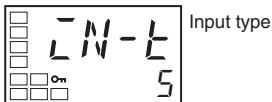

Operation Level

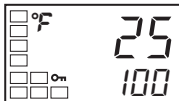

Adjustment Level

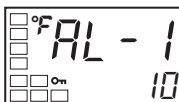
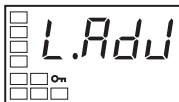

1. Press the key to move from the operation level to the adjustment level.
2. Press the key for at least three seconds to move from the adjustment level to the initial setting level.
3. Select the "alarm 1 type" parameter by pressing the key. Change the set value to 2. The default value is 12 (Annunciator alarm).
4. To return to the operation level, press the key for at least one second.
5. Press the key to move from the operation level to the adjustment level.
6. Select the "alarm value 1" parameter by pressing the key.
7. Use the key to set the parameter to 10.

■ Annunciator

- The annunciator output is provided to notify the user when a limit has been exceeded.
- This function can be used only when the alarm 1 type and alarm 2 type are both set to 12 (annunciator alarm).
- The annunciator output is turned ON when the limit is exceeded and turned OFF by the reset operation (i.e., by pressing the Reset Key for 1 second or more).

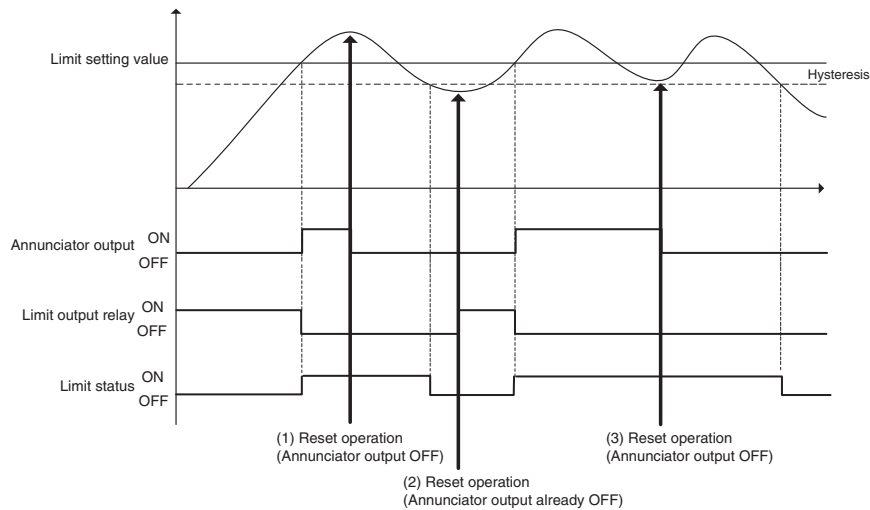

SECTION 4

Applications Operations

This section describes each function in detail to help make the most of the E5CN-FR Limit Controller's functionality and capabilities.

4.1	Shifting Input Values	4-2
	Shifting Inputs	4-2
	How to Calculate Input Shift Values for a 2-point Shift	4-4
4.2	Alarm Hysteresis	4-7
	Standby Sequence	4-7
	Alarm Latch	4-7
	Close in Alarm/Open in Alarm	4-8
4.3	Using Event Inputs.....	4-10
	Event Input Functions.....	4-10
4.4	Monitoring the Limit Over Continuation Time	4-12
	Limit Over Continuation Time	4-12
4.5	Monitoring the Limit Over Minimum/Maximum Value..	4-14
	Limit Over Minimum/Maximum Value	4-14
4.6	Setting the Limit Output Operation at Startup.....	4-15
	Restart Mode	4-15
4.7	Moving to the Advanced Function Setting Level.....	4-17
4.8	Using the Key Protect Level.....	4-19
	Protection	4-19
	Entering the Password to Move to the Protect Level.....	4-20
	Communications Operation Command to Move to the Protect Level.....	4-22
4.9	PV Change Color.....	4-23
	PV Color Change Function.....	4-23
	Setting	4-23

4.1 Shifting Input Values

■ Shifting Inputs

The input shift matched to the sensor currently selected in the “input type” parameter is displayed.

Input type	Input type set value	Shift method	Related parameters
Resistance thermometer or thermocouple input	0 to 18	One-point shift	Temperature input shift value
Infrared Thermosensor	19 to 22	Two-point shift	Upper-limit temperature input shift value Lower-limit temperature input shift value

● One-point shift

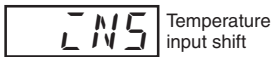

- With a 1-point shift, the value set for the “temperature input shift” parameter (adjustment level) is applied to each point in the entire temperature input range. For example, if the input shift value is set to 1.2°C, the process value is treated as 201.2°C after the input shift is applied when the measured process value is 200°C.

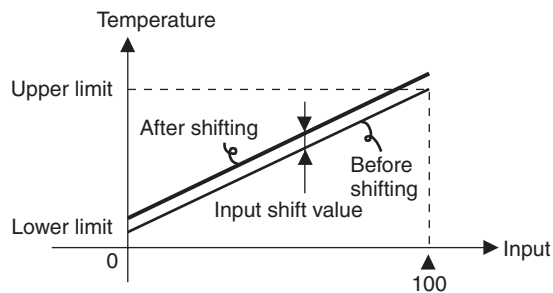

● Operating Procedure

Operation Level

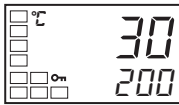

Adjustment Level

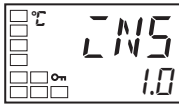
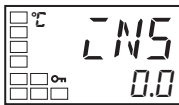
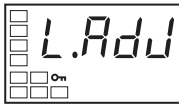

Operation Level

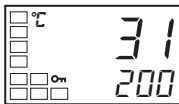

● Two-point shift



In this example, the input from a K sensor is shifted by 1°C.

1. Press the key to move from the operation level to the adjustment level.
2. Select the “temperature input shift” parameter by pressing the key.
3. Press the or key to set 1.0.
4. To return to the operation level, press the key. The process value is 1°C larger than before the shift was applied.

- With an infrared thermosensor, separate shift values can be set for the upper limit and lower limit of the sensor input range. If different shift values are set for the upper limit and lower limit, then the slope of the line will be different before and after applying the input shift. For example, if the upper-limit value is set to 2°C and the lower-limit value is set to 1°C, the input temperature will be shifted by 1.5°C for a 50% input, i.e., by the average of the upper-limit and lower-limit values.
- Set the upper-limit value in the “upper-limit temperature input shift value” parameter and the lower-limit value in the “lower-limit temperature input shift value” parameter.

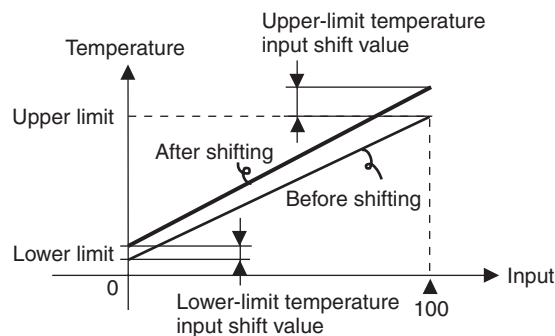

■ How to Calculate Input Shift Values for a 2-point Shift

When an ES1B Infrared Thermosensor is connected to the E5CN-FR, an offset of several degrees to several tens of a degree can occur.

This offset occurs because a bias current for detecting a Limit Controller sensor error flows to the output impedance of the ES1B Infrared Thermosensor.

● Preparations

1. Set a temperature range matching the input specifications of the infrared temperature sensor.
2. Prepare a thermometer capable of measuring the temperature of the control target as shown in so that a 1-point shift or 2-point shift can be carried out.
3. The E5CN-FR□□PB have a built-in external power supply for ES1B Infrared Thermosensors. These E5CN models can be used as the power supply when using ES1B. When ES1B are used with other E5CN models, provide a separate power supply for the Infrared Thermosensors.

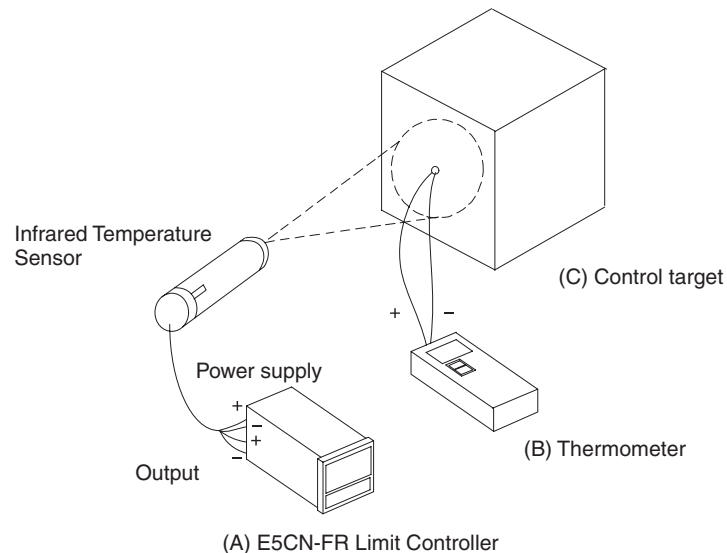

Figure 1 Offset Configuration for an Infrared Temperature Sensor

● Method for a 1-point Shift

1. In the configuration shown in Figure 1, adjust the temperature of the controlled system so that it is near the limit setting value. Assume that the control target temperature (C) and the thermocouple temperature (B) are the same.
2. Check the control target temperature (B) and the Controller readout (A). Subtract the Controller readout temperature (A) from the control target temperature (B), and set $\bar{I}NSL$ and $\bar{I}NSH$ to the result as the input shift value. The shift is illustrated in .

- After setting the input shift values, check the Controller readout (A) and the control target temperature (B). If they are almost the same, this completes shifting the temperature input.

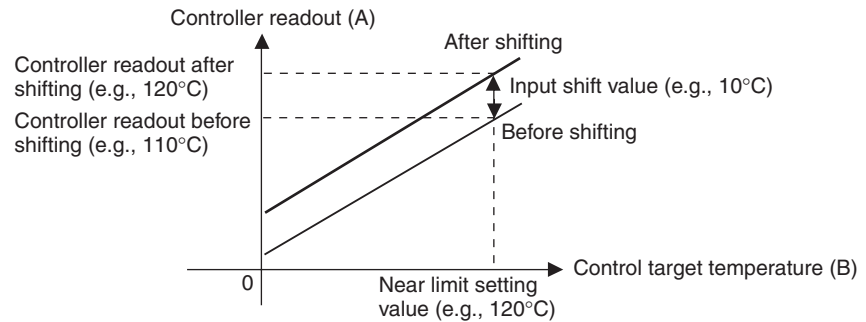

Figure 2 Illustration of 1-Point Shift

● Method for a 2-point Shift

Use a 2-point input shift if you want to increase the accuracy of the readout values across the range of the sensor.

- Adjust the Controller readout at two points, one near room temperature and the other near the limit setting value temperature. To adjust the temperatures, it is necessary to check the Controller readout (A) and the temperature of the controlled system (B) with the controlled system's temperature near room temperature and near the set point.
- Then use the following formulas to calculate the upper-limit and lower-limit temperature input shift values based on the readout temperatures and desired temperatures.

The shift is illustrated in Figure 3.

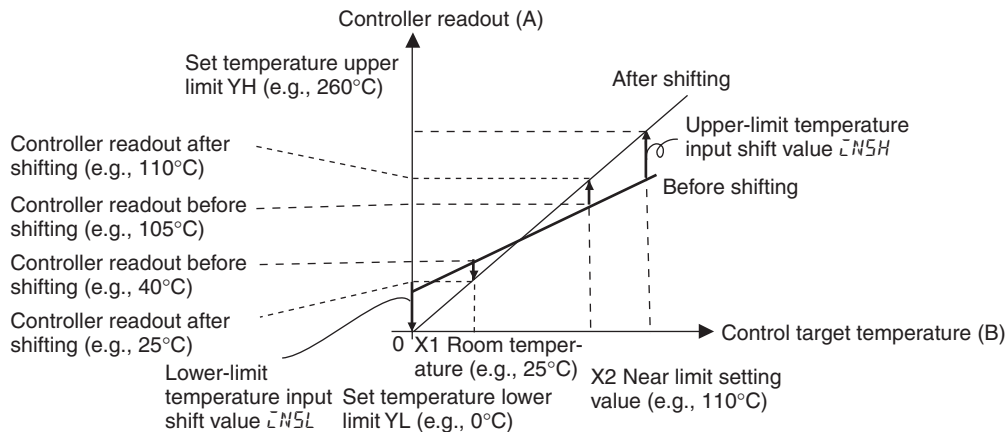

Figure 3 Illustration of 2-Point Shift

- Lower-limit temperature input shift value

$$\Delta NSL = \frac{Y_L - Y_1}{Y_2 - Y_1} \times \{(X_2 - Y_2) - (X_1 - Y_1)\} + (X_1 - Y_1) \text{ (}^\circ\text{C)}$$

- Upper-limit temperature input shift value

$$\Delta NSH = \frac{Y_H - Y_1}{Y_2 - Y_1} \times \{(X_2 - Y_2) - (X_1 - Y_1)\} + (X_1 - Y_1) \text{ (}^\circ\text{C)}$$

3. After setting the calculated values to \bar{LNSL} and \bar{LNSH} , check the Limit Controller readout (A) and control target temperature (B).
4. Here, offsets are set at two points, near room temperature and near the limit setting value. To improve accuracy within the temperature measurement range, another point in the measurement temperature range other than the limit setting value should be set instead of room temperature.

● Example of a 2-point Temperature Input Shift

In this example, we use the ES1B with a 0 to 260°C specification. In equations 1 and 2, the set temperature lower limit YL is 0°C and the set temperature upper limit YH is 260°C. Check the temperature of the control target.

The temperature input shift values can be calculated as shown below when the Limit Controller readout Y1 is 40°C for a room temperature X1 of 25°C and when the Limit Controller readout Y2 is 105°C for a Temperature near limit setting value X2 of 110°C.

Lower-limit Temperature Input Shift Value

$$\bar{LNSL} = \frac{0 - 40}{105 - 40} \times \{(110 - 105) - (25 - 40)\} + (25 - 40) = -27.3 \text{ (}^\circ\text{C)}$$

Upper-limit Temperature Input Shift Value

$$\bar{LNSH} = \frac{260 - 40}{105 - 40} \times \{(110 - 105) - (25 - 40)\} + (25 - 40) = 52.7 \text{ (}^\circ\text{C)}$$

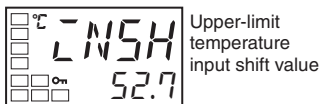
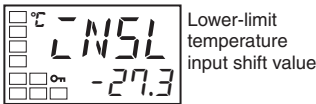

4.2 Alarm Hysteresis

- The hysteresis of alarm outputs when alarms are switched ON/OFF can be set as follows:

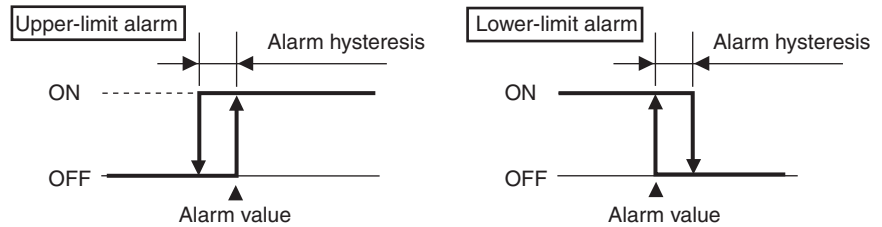

- Alarm hysteresis is set independently for each alarm in the “alarm hysteresis 1” to “alarm hysteresis 2” parameters (advanced function setting level).
- The default value is 0.2 (°C or °F).

■ Standby Sequence

- The standby sequence can be used so that an alarm will not be output until the process value leaves the alarm range once and then enters it again.
- For example, with a lower limit alarm, the process value will normally be below the limit setting value, i.e., within the alarm range, when the power supply is turned ON, causing an alarm to be output. If the lower limit alarm with a standby sequence is selected, an alarm will not be output until the process value increases above the alarm set value, i.e., until it leaves the alarm range, and then falls back below the alarm set value.

● Restart

- The standby sequence is canceled when an alarm is output. It is, however, restarted later by the “standby sequence reset” parameter (advanced function setting level). For details, refer to the “standby sequence reset” parameter in *SECTION 5 Parameters*.

■ Alarm Latch

- The alarm latch can be used to keep the alarm output ON regardless of the temperature once the alarm output has turned ON. The alarm output will turn OFF when the power is turned OFF.
- (The alarm output can also be turned OFF by switching to the initial setting level, communications setting level, advanced function setting level, or calibration level.)
- When an Annunciator alarm is selected as the alarm type, this function is disabled and not displayed.

■ Close in Alarm/Open in Alarm

- When “close in alarm” is set, the status of the alarm output function will be output as is. When “open in alarm” is set, the status of the alarm output function will be reversed before being output.
- Close in alarm/open in alarm can be set separately for each alarm.
- Close in alarm/open in alarm is set in the “alarm 1 open in alarm” to “alarm 2 open in alarm” parameters (advanced function setting level).
- The default is $N-\bar{a}$ (close in alarm).

Setting	Alarm status	Alarm indicator	Alarm output
Close in alarm	ON	Lit	ON
	OFF	Not lit	OFF
Open in alarm	ON	Lit	OFF
	OFF	Not lit	ON

- The alarm outputs will turn OFF (i.e., the relay contacts will open) when power is interrupted and for about two seconds after the power is turned ON regardless of the close in alarm/open in alarm setting.

● Summary of Alarm Operation

The following figure summarizes the operation of alarms when the alarm type is set to “lower-limit alarm with standby sequence” and “close in alarm” is set.

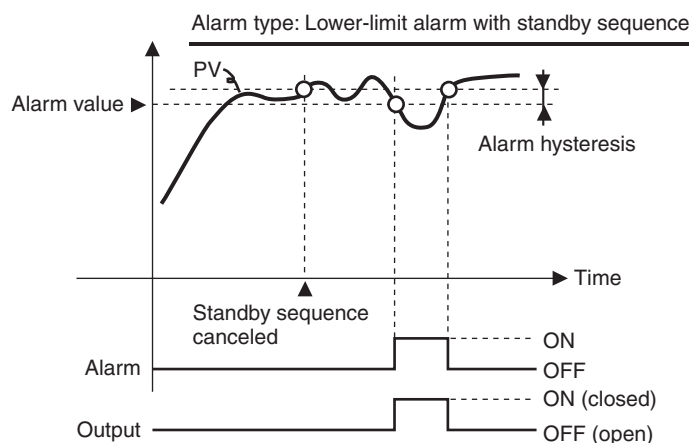

Parameters

Symbol	Parameter: Level	Description
RLH^*	Alarm 1 to 2 hysteresis: Advanced function setting level	Alarm
$RESL$	Standby sequence: Advanced function setting level	Alarm
RL^*N	Alarm 1 to 2 open in alarm: Advanced function setting level	Alarm

* = 1 to 2

● Alarm Operation for Sensor Error and Display Range Exceeded

The following alarm operation will be performed when there is an input error or the value exceeds the display range.

Error	Alarm output
Input error <i>S.ERR</i>	Operating at abnormally high temperature
Over lower-limit indication range <i>-L_o-</i>	Operating at abnormally low temperature
Over upper-limit indication range <i>-H_o-</i>	Operating at abnormally high temperature

4.3 Using Event Inputs

■ Event Input Functions

- An external input can be used to reset the limit output or clear the limit over continuation time and limit over minimum/maximum value.
- There are two event inputs and each input can be assigned a separate function.
- Assign functions to the event inputs with the "event input assignment 1" and "event input assignment 2" parameters.

Setting item	Set Value	Settings
Event input assignment 1 ($E\bar{V}-1$) or Event input assignment 2 ($E\bar{V}-2$)	$NONE$	None
	$RSET$	Reset limit output
	$HCLR$	Clear the limit over continuation time and limit over minimum/maximum value.

- When one event input is set to $RSET$ or $HCLR$, the other event input can only be set to the other function.
- The limit output reset operation resets the limit output and also resets the annunciator alarm. The operation is reset when the event input changes from OFF to ON.
 - Note 1. If the limit status is OFF, the limit output will be reset and the limit output relay will go ON.
 - Note 2. If the limit status is still ON (i.e., if the PV still exceeds the limit setting value), the limit output will not be reset.
 - Note 3. The annunciator alarm will be turned OFF regardless of the limit status.
- The limit over continuation time and the limit over minimum/maximum value are cleared when the event input changes from OFF to ON.
- When an event input is used to clear the limit over continuation time and the limit over minimum/maximum value, those values cannot be cleared separately. (To clear one of these values independently, the value must be cleared with the key operation.)
- The default setting is $NONE$.

● Operating Procedure

The following example shows how to set event input assignment 1 to *RSET* (reset limit output).

Operation Level



Adjustment Level



Initial Setting Level

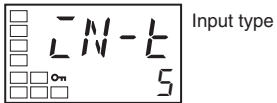

Advanced Function Setting Level

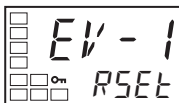
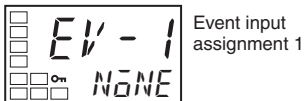

1. Press the key to move from the operation level to the adjustment level.

2. To return to the initial setting level, press the key for at least three seconds.

3. Press the key to select the "move to advanced function setting level" parameter.

4. Use the and keys to input -169.
Move to the advanced function setting level by pressing the key or touching no keys for at least two seconds.

5. Press the key to select the "event input assignment 1" parameter.

6. Use the and keys to select *RSET*.

4.4 Monitoring the Limit Over Continuation Time



■ Limit Over Continuation Time



- This function measures and displays the elapsed time that the process value (PV) has exceeded the limit setting value. (The timer range is 0.00 to 99.59 (0 hours 0 minutes to 99 hours 59 minutes).)
- The timing method used for the limit over continuation time can be set as shown below.

Set value	Operation
L.OUT	Measures the time that the limit output relay is OFF (limit alarm ON).
L.STS	Measures the time that the limit status is ON.

- The default setting is L.OUT.
- If the timer has been cleared or PV hasn't exceeded the limit setting value even once since power was turned ON, "----" will be displayed for the limit over continuation time on the No. 2 display.
- The limit over continuation time is initialized to the "----" display when power is turned ON or when moving from initial setting level to operation level (i.e., to software resets).

To clear the limit over continuation time, press both the  and  Keys together for at least one second while the limit over continuation time is being displayed. (The timer can also be cleared using an event input.)

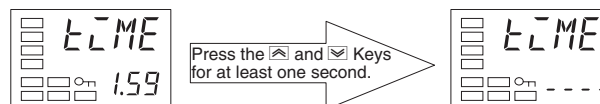

Advanced Function Setting Level

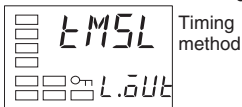

- When the timing method is set to L.OUT, the timer operates as shown in the following diagram.

Example Operation with Upper Limit and Timer Method = L.OUT

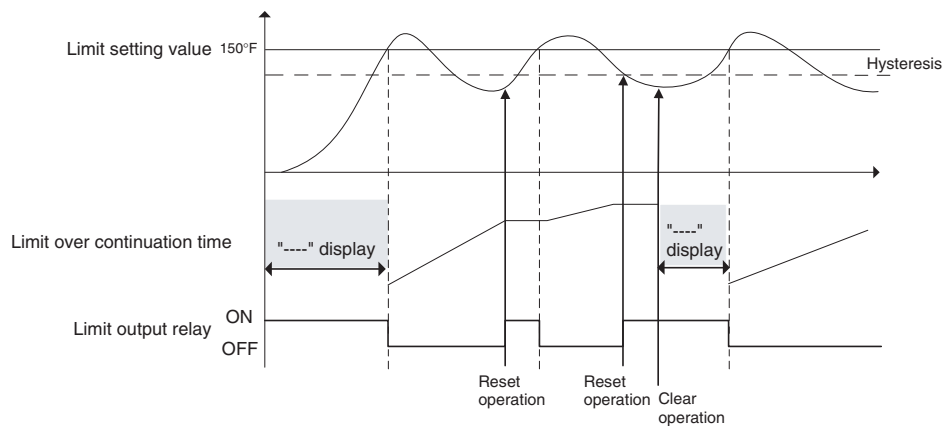

Advanced Function Setting Level

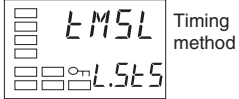

- When the timing method is set to L.5L5, the timer operates as shown in the following diagram.

Example Operation with Upper Limit and Timer Method = L.STS

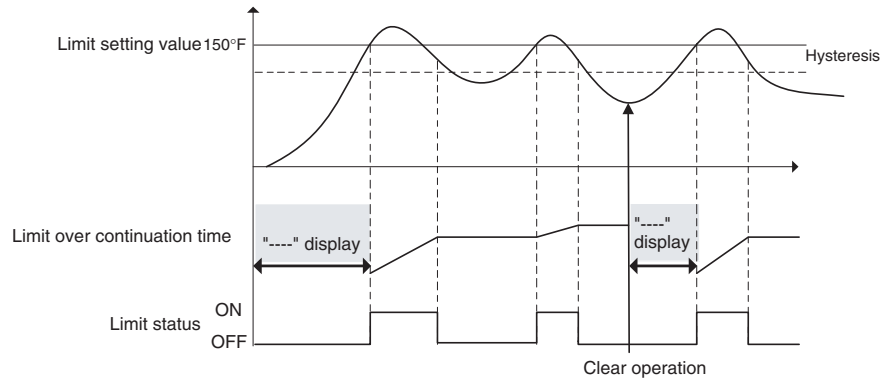

● Operating Procedure

The following example shows how to monitor the limit over continuation time.

Operation Level

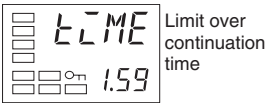
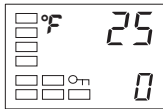



- Press the key in the operation level to select the limit over continuation time.
- The limit over continuation time will be shown on the No. 2 display (1 hour 59 minutes in this example).

4.5 Monitoring the Limit Over Minimum/Maximum Value

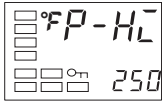
■ Limit Over Minimum/Maximum Value



- When the "selecting upper/lower limit" parameter has been set for upper limit (high) operation, this function records the maximum PV when the PV exceeds the limit setting value and displays that peak value as the limit over maximum value.
- When the "selecting upper/lower limit" parameter has been set for lower limit (low) operation, this function records the minimum PV when the PV is below the limit setting value and displays that lowest value as the limit over minimum value.
- The displayable range of the limit over minimum/maximum value depends on the decimal point position setting and input type setting.
- When the timer has been cleared or PV hasn't exceeded the limit setting value even once since power was turned ON, "----" will be displayed for the limit over minimum/maximum value on the No. 2 display.
- The limit over minimum/maximum value is initialized to the "----" display when the power is turned ON or when moving from initial setting level to operation level (i.e., software resets).
- To clear the limit over minimum/maximum value, press both the  and  Keys together for at least one second while the limit over minimum/maximum value is being displayed. (The maximum/minimum value can also be cleared using an event input.)

Limit over maximum value

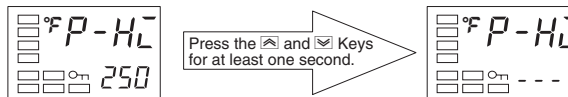

Limit over minimum value

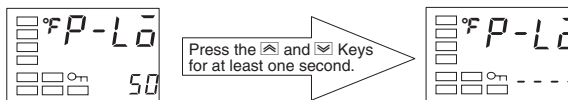

● Operating Procedure

Operation Level

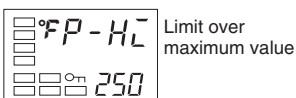
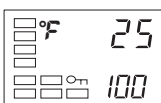

The following example shows how to monitor the limit over minimum/maximum value.

1. Press the  key in the operation level to select the limit over minimum/maximum value.
2. The limit over minimum/maximum value will be shown on the No. 2 display (a maximum value of 250 in this example).

4.6 Setting the Limit Output Operation at Startup

Restart Mode

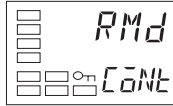

The Restart Mode setting is used to specify the status of the limit output when power is turned ON.

Set value	Operation
CONT	The output status is determined by the relationship between the limit setting value (SP) and the process value (PV) when the power is turned ON. (See note.) With an upper limit (high limit), the limit output will be OFF (limit alarm ON) if the PV exceeds the SP.
STOP	The Controller always starts with the limit output OFF when the power is turned ON. The Controller can be put into monitor status by resetting the limit output.

- The default setting is CONT.

Note: If the power was interrupted when the limit alarm was ON (limit output OFF), that alarm status will be maintained the next time that power is turned ON and the Controller will start with the limit alarm ON (limit output OFF). The following diagram shows an example of operation at startup.

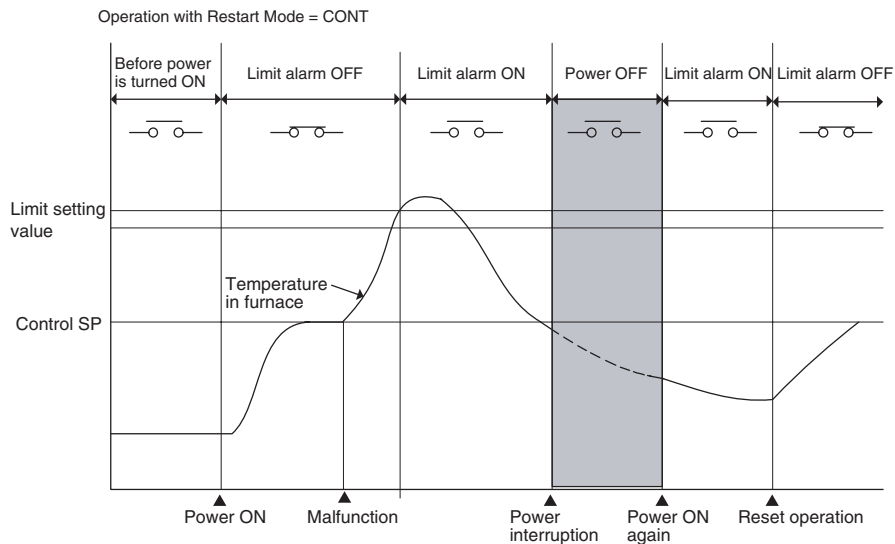

● Operating Procedure

Operation Level

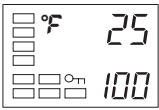

Adjustment Level

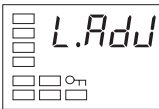

Initial Setting Level

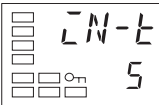

Move to advanced function setting level



Advanced Function Setting Level



Restart mode



Initial Setting Level

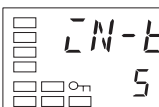

Operation Level

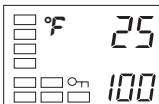

The following example shows how to set the restart mode to *StOP*.

1. Press the key to move from the operation level to the adjustment level.
2. To return to the initial setting level, press the key for at least three seconds.
3. Press the key to select the "move to advanced function setting level" parameter.
4. Use the and keys to input -169.
Move to the advanced function setting level by pressing the key or touching no keys for at least two seconds.
5. Select the "restart mode" parameter by pressing the key.
6. Press the or key to select either *LNt* or *StOP*.
7. To return to the initial setting level, press the key for at least one second.
8. To return to the operation level, press the key for at least one second.

4.7 Moving to the Advanced Function Setting Level

To move to the advanced function setting level, you must first cancel the protection applied by the “initial setting/communications protect” parameter.

In the default setting, the advanced function setting level is protected and you cannot move to this setting level.

● Operating Procedure

The following example shows how to clear initial setting/communications protection and move to the advanced function setting level and operation level.

Operation Level

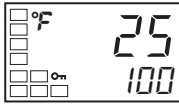

Protect Level



Operation/adjustment protect



Initial setting/communications protect

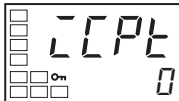

Operation Level

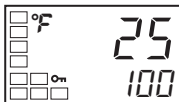

Adjustment Level

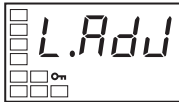

Initial Setting Level

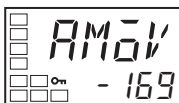
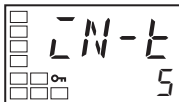

Move to advanced function setting level

1. Press the and keys simultaneously for at least three seconds in operation level.
2. The Controller moves to the protect level, and the “operation/adjustment protect” parameter is displayed.
3. Press the key once to move to the “initial setting/communications protect” parameter.
4. Set the set value to 0.
5. Press the and keys simultaneously for at least one second to return to the operation level.
6. Move to the advanced function setting level.
Press the key to move from the operation level to the adjustment level.
7. To move to the initial setting level, press the key for at least three seconds.
8. Select the “move to advanced function setting level” parameter by pressing the key.

Advanced function setting level



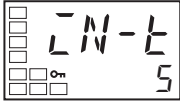

Initial Setting Level

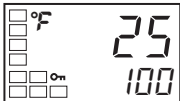

Operation Level





9. Press the  key, enter the password (-169), and then either press the  key or leave the setting for at least two seconds to move to the advanced function setting level from the initial setting level.

10. To return to the initial setting level, press the  key for at least one second.

11. To return to the operation level, press the  key for at least one second.

4.8 Using the Key Protect Level

■ Protection

- To move to the protect level, press the  and  keys simultaneously for at least three seconds in operation level or adjustment level.
- The protect level protects parameters that are not changed during Controller operation until operation is started to prevent them from being modified unintentionally.

There are three types of protection: operation/adjustment protect, initial setting/communications protect, and setting change protect.

- The protect level settings restrict the range of parameters that can be used.

● Operation/Adjustment Protect



The following table shows the relationship between set values and the range of protection.

Level		Set value		
		0	1	2
Operation level	PV/Limit setting value or Limit setting value	Can be displayed	Can be displayed	Can be displayed
	Others	Can be displayed	Can be displayed	Cannot be displayed.
Adjustment level		Can be displayed and changed	Cannot be displayed.	Cannot be displayed.

- Parameters are not protected when the set value is set to 0.
- The default is 0.
- To conform to FM standards (prevention of unintentional changes to settings such as the limit setting value), use a protection setting of 1 or 2 during normal operation. With these protection settings, the Level/Reset Key operates only as a reset key (resetting the limit output).

● Initial Setting/Communications Protect



This protect level restricts movement to the initial setting level, communications setting level, and advanced function setting level.

Level	Set value		
	0	1	2
Initial setting level	Movement possible	Movement possible	Movement not possible
Communications setting level	Movement possible	Movement possible	Movement not possible
Advanced function setting level	Movement possible	Movement not possible	Movement not possible

- The default is 1.

● Setting Change Protect

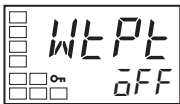

This protect level restricts key operations.

Set value	Description
OFF	Settings can be changed using key operations.
ON	Settings cannot be changed using key operations. (The protect level settings, however, can be changed.)

- The default is OFF.
- The all protect indication (On) will light when setting change protect is set.

■ Entering the Password to Move to the Protect Level

- Protect level can be moved to only by display the password display and entering the correct password. (The user can set any password in the “protect level password” parameter. If no password is set (i.e., if the password is set to 0 in the “protect level password” parameter), the password input display to move to protect level will not be displayed and the protect level can be moved to directly.

● Operating Procedure

Use the following procedure to move to protect level.

Example with a Password of 1234

Operation Level



1. Press the and keys simultaneously for at least three seconds to move from the operation level to the protect level.

Protect Level

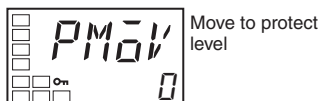

2. Press the key to set the parameter to 1234 (password input).



3. Move to the "operation/adjustment protect" parameter by pressing the or key or leaving the setting for at least two seconds.



Operation/adjustment protect

Operation Level

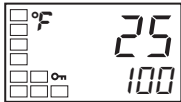

PV/Limit set point

Example with No Password Set

Press the and keys simultaneously for at least three seconds to move from the operation level to the protect level.

When a password is not set, the "operation/adjustment protect" parameter will be displayed.

Protect Level



Operation/adjustment protect

● Setting the Password Operating Procedure

Use the following procedure to set the password to move to the protect level.

Example To set the Password to 1234

Operation Level

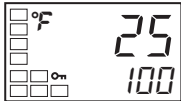

1. Press the and keys simultaneously for at least three seconds to move from the operation level to the protect level.

Protect Level



Operation/adjustment protection

2. Select the "password to move to protect level" parameter by pressing the key.



Password to move to protect level

3. Press the and keys to set the parameter to 1234.
(To prevent setting the password incorrectly, the and keys or and keys must be pressed simultaneously to set the password.)

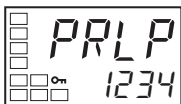

* Protection cannot be cleared or changed without the password. Be careful not to forget it. If you forget the password, contact your OMRON sales representative.

■ Communications Operation Command to Move to the Protect Level

- The Write Variable operation command can be used via communications to write the password to the “move to protect level” parameter. When the correct password is written, the display will change to the “operation/adjustment protect” parameter and writing the parameters in the protect level will be enabled.

Note 1. If the Write Variable operation command is used to write the wrong password to the “move to protect level” parameter after the correct parameter has been written, the “move to protect level” parameter will be displayed and any Write Variable operation commands to write parameters in the protect level will result in operation errors.

Note 2. If a password is not set or if it is set to 0, the display will change to the “operation/adjustment protect” parameter and writing the parameters in the protect level will be enabled immediately.

4.9 PV Change Color

■ PV Color Change Function

Use the PV color change function to change the color of the PV display (No. 1 display).

There are two display colors, red and green, and you can select from the following three modes and six types.



- Constant: This mode displays red or green all the time.
- Linked to Alarm 1: This mode switches the PV display color from red to green when alarm 1 turns ON or from green to red when alarm 1 turns ON.
- Linked to Limit Status: This mode switches the PV display color between red and green depending on the limit status.
- The default setting is *L.G-R* (Green → Red).

The following tables shows the display functions that can be set using the PV color change function.

Mode	Setting	Indicator color	Function
Fixed display	<i>REd</i>	Red	Always red
	<i>GRM</i>	Green	Always green
Linked to alarm 1	<i>R.R-G</i>	Red to Green	Green when ALM1 indicator is lit.
	<i>R.G-R</i>	Green to Red	Red when ALM1 indicator is lit.
Linked to limit status	<i>L.R-G</i>	Red to Green	Green when limit status is ON.
	<i>L.G-R</i>	Green to Red	Red when limit status is ON.

■ Setting

The color is set so that it is linked to limit status and the indicator switches from green to red (red when the limit status is ON).

● Operating Procedure

PV change color = *L.G-R* (Green to Red)

Release the protection before setting the "PV change color" parameter so that it is possible to move to the advanced function setting level.

Operation Level

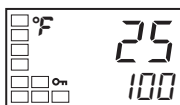

1. Press the key to move from the operation level to the adjustment level.

Adjustment Level



Initial Setting Level

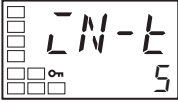

Move to advanced function setting level

Advanced Function Setting Level

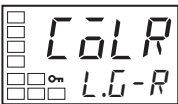
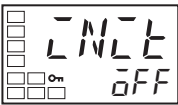

PV change color

Initial Setting Level

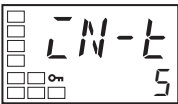

Operation Level

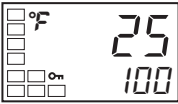

2. Press the key for at least three seconds to move from the adjustment level to the initial setting level.
3. Select the “move to advanced function setting level” parameter by pressing the key.
4. Use the key to enter “-169” (the password).
Move to the advanced function setting level by pressing the key or touching no keys for at least two seconds.
5. Select the “PV change color” parameter by pressing the key.
6. Press the key to set the parameter to *L.G-R*.
7. To return to the initial setting level, press the key for at least one second.
8. To return to the operation level, press the key for at least one second.

An operation example for setting the upper limit to *L.G-R* (Green to Red) (red when limit status is ON) is shown in the following diagram.

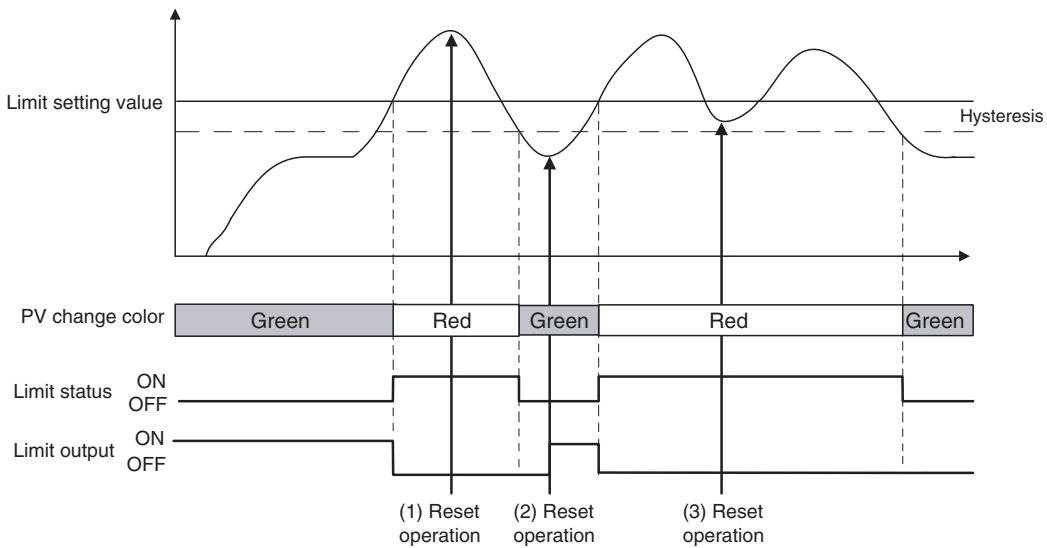

SECTION 5

Parameters

This section describes the E5CN-FR Limit Controller's parameter settings. Use this section as a reference.

5.1	Conventions Used in this Section	5-2
	Meanings of Icons Used in this Section.....	5-2
	About Related Parameter Displays	5-2
	Order in Which Parameters Are Described in This Section	5-2
5.2	Protect Level.....	5-3
5.3	Operation Level.....	5-6
5.4	Adjustment Level	5-9
5.5	Initial Setting Level.....	5-15
5.6	Advanced Function Setting Level	5-21
5.7	Communications Setting Level	5-31

5.1 Conventions Used in this Section

● Meanings of Icons Used in this Section



Function

Describes the functions of the parameter.



Setting

Describes the setting range and default of the parameter.



Monitor

Used to indicate parameters used only for monitoring.



Operation

Describes the parameter settings, such as those for Operation Commands, and procedures.



See

Used to indicate information on descriptions in which the parameter is used or the names of related parameters.

● About Related Parameter Displays

Parameters are displayed only when the conditions for use given on the right of the parameter heading are satisfied. Protected parameters are not displayed regardless of the conditions for use, but the settings of these parameters are still valid.

Temperature Input Shift

The input type parameter must be set to thermocouple or resistance thermometer.

Displayed symbol

Parameter name

Conditions for use

● Order in Which Parameters Are Described in This Section

Parameters are described level by level.

The first page of each level describes the parameters in the level and the procedure to switch between parameters.

5.2 Protect Level

Three levels of protection are provided on the E5CN-FR, operation/adjustment protect, initial setting/communications protect, and setting change protect. These protect levels prevent unwanted operation of the keys on the front panel in varying degrees.

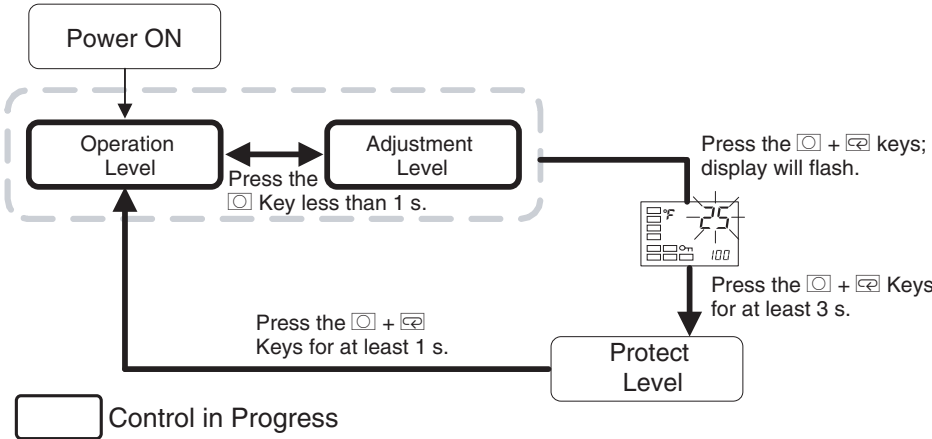

To move from the operation level to the protect level, press \square and \square keys for three seconds or more.

Protect Level		Page
\square PMoV	Move to protect level Displayed only when a password is set.	5-4
\square oAPt	Operation/adjustment protect	5-4
\square cCPt	Initial setting/communications protect	5-4
\square WtPt	Setting change protect	5-4
\square PPLP	Password to move to protect level	5-5

Parameters that are protected will not be displayed and their settings cannot be changed.

PMōV**Move to Protect Level**

The “password to move to protect level” password must not be set to 0.



- The password to move to the protect level is entered for this parameter.
- The password to move to the protect level (i.e., the password set for the “password to move to protect level” parameter) is entered for this parameter.
 - The “operation/adjustment protect” parameter will be displayed if the correct password is entered.

**Related Parameters**

Password to move to protect level (protect level): Page 5-5

ōAPE**Operation/Adjustment Protect****ĿĿPE****Initial Setting/Communications Protect****WEPE****Setting Change Protect**

These parameters specify the range of parameters to be protected. Shaded settings indicate the defaults.

Operation/Adjustment Protect

The following table shows the relationship between set values and the range of protection.



Level		Set value		
		0	1	2
Opera- tion Level	PV/Limit setting value or Limit set- ting value	Can be dis- played	Can be dis- played	Can be dis- played
	Others	Can be dis- played	Can be dis- played	Cannot be dis- played
Adjustment Level		Can be dis- played and changed	Cannot be dis- played	Cannot be dis- played

- Parameters are not protected when the set value is set to 0.
- To conform to FM standards (prevention of unintentional changes to settings such as the limit setting value), use a protection setting of 1 or 2 during normal operation. With these protection settings, the Level/Reset Key operates only as a reset key (resetting the limit output).

Initial Setting/Communications Protect

This protect level restricts movement to the initial setting level, communications setting level, and advanced function setting level.

Level	Set value		
	0	1	2
Initial setting level	Movement possible	Movement possible	Movement not possible
Communications setting level	Movement possible	Movement possible	Movement not possible
Advanced function setting level	Movement possible	Movement not possible	Movement not possible

Setting Change Protect

Changes to settings using key operations are restricted.

Set value	Description
OFF	Settings can be changed using key operations.
ON	Settings cannot be changed using key operations. (The protect level settings, however, can be changed.)

- The all protect indication (**On**) will light when setting is ON.

PRLP

Password to Move to Protect Level



Function



Setting

This parameter is used to set the password to move to the protect level.

- To prevent setting the password incorrectly, the and keys or and keys must be pressed simultaneously to set the password.

Setting range	Default
-1999 to 9999	0

- Set this parameter to 0 when no password is to be set.

Related Parameters

Move to protect level (protect level): Page 5-4

Note: Protection cannot be cleared or changed without the password.

Be careful not to forget it. If you forget the password, contact your OMRON sales representative.



See

5.3 Operation Level

Display this level to perform control operations on the E5CN-FR. This is a monitor-only level that allows monitoring of the process value, limit setting value, limit over continuation time, and limit over minimum/maximum value.

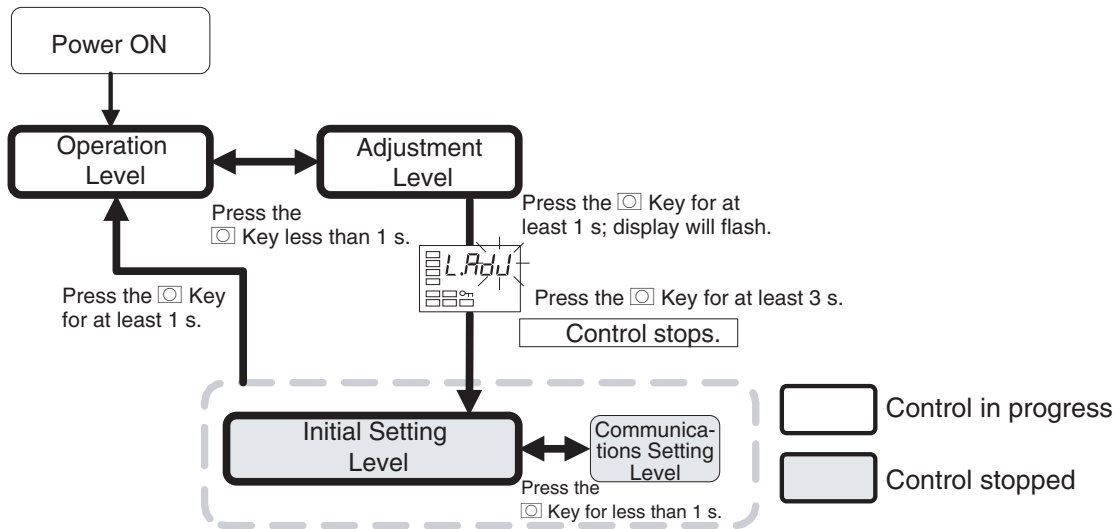

This level is displayed immediately after the power is turned ON. To move to other levels, press the [F] key or the [F] and [↵] keys. (Simultaneously)

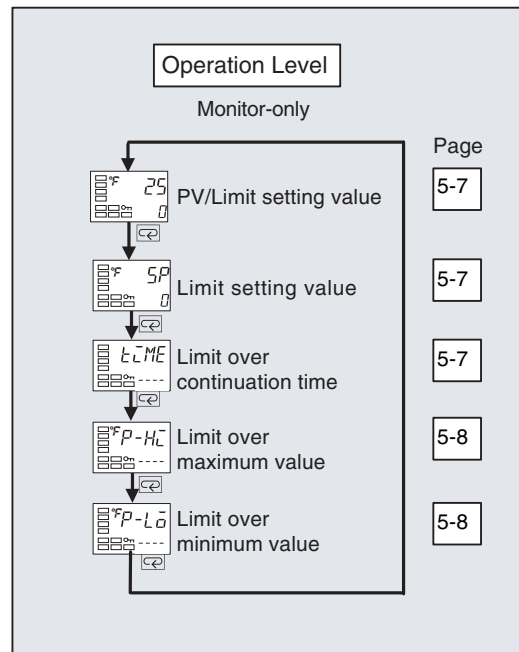

Process Value/Limit Setting Value

The “additional PV display” parameter must be set to ON.



Function



Monitor

The process value is displayed on the No. 1 display, and the limit setting value is displayed on the No. 2 display.

The decimal point position is set automatically based on the selected sensor.

	Monitor range	Unit
Process value	Input indication range (See page A-11.)	EU

	Monitor range	Unit
Limit setting value	Lower limit of input setting range to upper limit of input setting range	EU



See

Related Parameters

Input type: Page 5-16

5P

Limit Setting Value

The “additional PV display” parameter must be set to OFF.



Function



Monitor

The limit setting value is displayed on the No. 2 display.

The decimal point position is set automatically based on the selected sensor.

	Monitor range	Unit
Process value	Input indication range (See page A-11.)	EU

E \bar{L} ME

Limit Over Continuation Time





Function



Monitor

Measures the elapsed time that the process value has exceeded the limit setting value and displays the total time on the No. 2 display.

Monitor range	Unit
0.00 to 99.59	Hours.Minutes

- The display format for the total time is hr.mn, where hr is hours and mn is minutes.
- When the total time exceeds 99 hours and 59 minutes, the value is clamped at 99 hours and 59 minutes.
- To clear the limit over continuation time, press both the  and  Keys together for at least one second while the limit over continuation time is being displayed.
- The limit over continuation time is initialized to the "----" display when power is turned ON or when moving from initial setting level to operation level (i.e., to software resets).
- When the total time has been cleared or PV hasn't exceeded the limit setting value even once since power was turned ON, "----" will be displayed in the No. 2 display.



$P-H\bar{c}$
 $P-L\bar{o}$

Limit Over Maximum Value
Limit Over Minimum Value



When the process value exceeds the upper limit setting value (or falls below the lower limit setting value), the maximum process value (or minimum process value for a lower limit setting value) is recorded and displayed in the No. 2 display.

	Monitor range	Unit
Limit over maximum value Limit over minimum value	Input indication range (See page A-11.)	EU

- The decimal point position is set automatically based on the selected sensor.
- (If a sensor error has been detected, *S.ERR* will be displayed.)
- To clear the limit over minimum/maximum value, press both the  and  Keys together for at least one second.
- The limit over minimum/maximum value is initialized to the "----" display when the power is turned ON or when moving from initial setting level to operation level (i.e., software resets).
- When the maximum/minimum value has been cleared or PV hasn't exceeded the limit setting value even once since power was turned ON, "----" will be displayed in the No. 2 display.

5.4 Adjustment Level

This level is used to set values such as the limit setting value, alarm values, and input shift values.

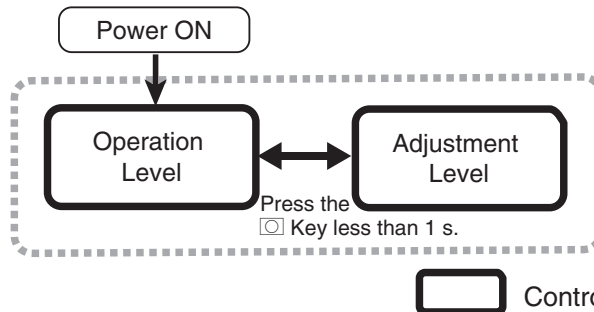

- To move to the adjustment level from the operation level, press the □ key once.
- Adjustment level parameters can be changed after setting the “operation/adjustment protect” parameter to 0. Displays and changing levels are not possible if the “operation/adjustment protect” parameter is set to 1 to 2. Protection is set in the protect level.

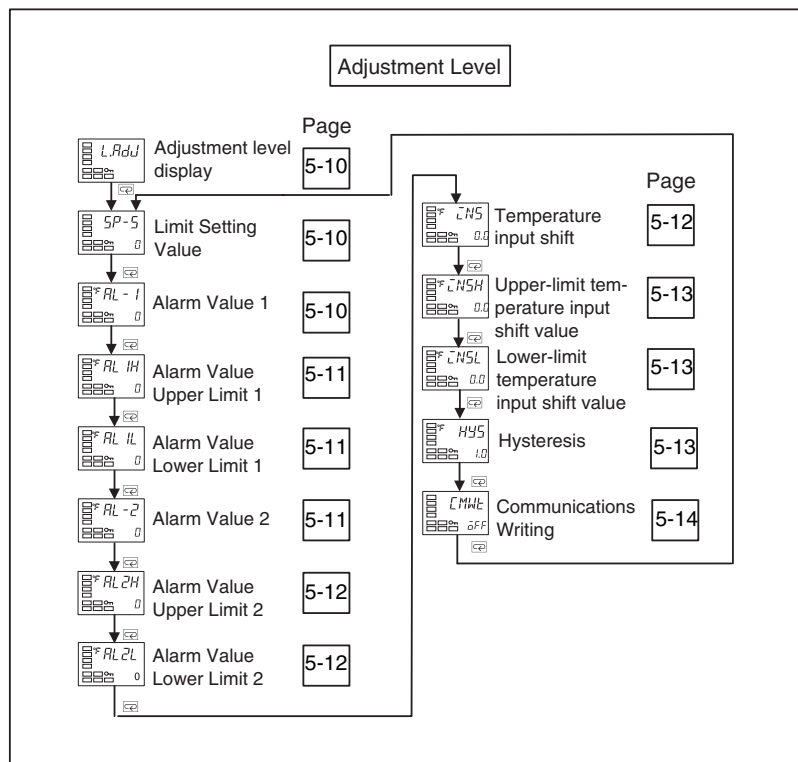

L.RdJ **Adjustment Level Display**

Function

This parameter is displayed after moving to the adjustment level.

- This parameter indicates that the adjustment level has been entered. (The “adjustment level” parameter will not be displayed again even if the  key is pressed in the adjustment level to scroll through the parameters.)

SP-5 **Limit Setting Value**

Function

Sets the limit setting value.

- Sets the temperature at which the limit function operates.
- The decimal point position is set automatically based on the selected sensor.



Setting

Setting range	Unit	Default
Lower limit of input setting range to upper limit of input setting range	EU	0

 See
Related Parameters

Input type: Page 5-16

RL - 1 **Alarm Value 1**

Alarm 1 must be assigned.
The alarm 1 type must not be set to an upper/lower limit alarm or annunciator alarm.



Function

This parameter is set to one of the input values "X" in the alarm type list.

- This parameter sets the alarm value for the alarm 1 output.
- The decimal point position is set automatically based on the selected sensor.



Setting

Setting range	Unit	Default
-1,999 to 9,999	EU	0

 See
Related Parameters

Input type: Page 5-16, Alarm 1 type: Page 5-18 (initial setting level), Standby sequence reset: Page 5-23, Alarm 1 open in alarm: Page 5-24, Alarm 1 hysteresis: Page 5-25, Alarm 1 latch: Page 5-27 (advanced function setting level)

RL -2**Alarm Value 2**

Alarm 2 must be assigned.
The alarm 2 type must not be set to an upper/lower limit alarm or annunciator alarm.



Function



Setting

See

This parameter is set to one of the input values "X" in the alarm type list.

- This parameter sets the alarm value for the alarm 2 output.
- The decimal point position is set automatically based on the selected sensor.

Setting range	Unit	Default
-1,999 to 9,999	EU	0

Related Parameters

Input type: Page 5-16, Alarm 2 type: Page 5-20 (initial setting level), Standby sequence reset: Page 5-23, Alarm 2 open in alarm: Page 5-24, Alarm 2 hysteresis: Page 5-25, Alarm 2 latch: Page 5-27 (advanced function setting level)

RL 1H**Alarm Value Upper Limit 1**

Alarm 1 must be assigned.
The alarm 1 type must be set to upper and lower limits, upper and lower limit range, or upper- and lower-limit with standby sequence.

RL 1L**Alarm Value Lower Limit 1**

Function



Setting

See

These parameters independently set the alarm value upper and lower limits when the mode for setting the upper and lower limits is selected for the "alarm 1 type" parameter (initial setting level).

- This parameter sets the upper and lower limit values of alarm 1.
- The decimal point position is set automatically based on the selected sensor.

Setting range	Unit	Default
-1,999 to 9,999	EU	0

Related Parameters

Input type: Page 5-16, Alarm 1 type: Page 5-18 (initial setting level), Standby sequence reset: Page 5-23, Alarm 1 open in alarm: Page 5-24, Alarm 1 hysteresis: Page 5-25, Alarm 1 latch: Page 5-27 (advanced function setting level)

AL2H**Alarm Value Upper Limit 2**

Alarm 2 must be assigned.
The alarm 2 type must be set to upper and lower limits, upper and lower limit range, or upper- and lower-limit alarm with standby sequence.

AL2L**Alarm Value Lower Limit 2**

These parameters independently set the alarm value upper and lower limits when the mode for setting the upper and lower limits is selected for the "alarm 2 type" parameter (initial setting level).

- This parameter sets the upper and lower limit values of alarm 2.
- The decimal point position is set automatically based on the selected sensor.



Function



Setting

Setting range	Unit	Default
-1,999 to 9,999	EU	0

See

Related Parameters

Input type: Page 5-16, Alarm 2 type: Page 5-20 (initial setting level), Standby sequence reset: Page 5-23, Alarm 2 open in alarm: Page 5-24, Alarm 2 hysteresis: Page 5-25, Alarm 2 latch: Page 5-27 (advanced function setting level)

IN5**Temperature Input Shift**

The input type must be set to thermocouple or resistance thermometer.

Sometimes an error occurs between the process value and the actual temperature. To offset this error, a compensated value can be obtained by adding an input shift value to the input. The compensated value is displayed as the measurement value and used for control.

- The entire input range is shifted by a fixed rate (1-point shift).
- If the input shift value is set to -1°C , control will be performed for a value 1°C lower than the measured temperature.



Function



Setting

Setting range	Unit	Default
-199.9 to 999.9	$^{\circ}\text{C}$ or $^{\circ}\text{F}$	0

See

Related Parameters

Input type (initial setting level): Page 5-16

INSH
INSL

Upper-limit Temperature Input Shift Value Lower-limit Temperature Input Shift Value

The “input type” parameter must be set for an infrared sensor.

These parameters are used to shift the input temperature at two points: an upper-limit temperature and a lower-limit temperature (as opposed to the “temperature input shift” parameter, which shifts the input temperature by setting the shift for only one point). A 2-point shift enables more accurate offset of the input range compared with a 1-point shift if the input shift values at the upper and lower limits differ.

- This parameter sets input shift values for the upper and lower limits (2-point shift) of the input range.



Function



Setting

Setting range	Unit	Default
-199.9 to 999.9	°C or °F	0.0

Related Parameters

Input type (initial setting level): Page 5-16

See

HYS

Hysteresis



Function



Setting

- This parameter sets a hysteresis value to stabilize operation at the limit status ON/OFF switching point.

Setting range	Unit	Default
-199.9 to 999.9	°C or °F	1.0

[MWE]

Communications Writing

Communications must be supported.



Function



Setting

- This parameter enables/disables writing of parameters to the E5CN-FR from the host (personal computer) using communications.

Setting range	Default
ON: Writing enabled	OFF
OFF: Writing disabled	

**Related Parameters**

Communications Unit No., Communications baud rate, Communications data length, Communications parity, Communications stop bits (communications setting level): Page 5-31

5.5 Initial Setting Level

This level is used to set up the basic Limit Controller specifications. In this level, you can set the "input type" parameter to set the sensor input to be connected, select upper limit or lower limit operation, set the alarm types, and perform other operations.

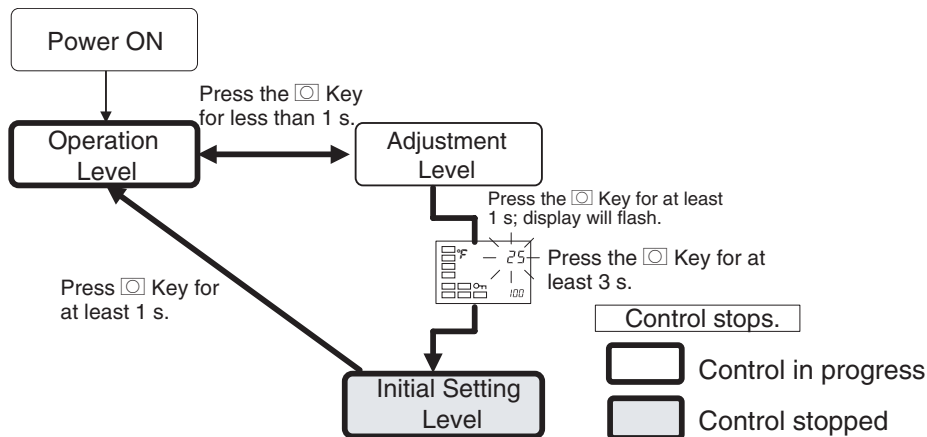

- Press the key for at least 3 seconds to move from the adjustment level to the initial setting level.
- The initial setting level is not displayed when the "initial/communications protect" parameter is set to 2. It can be used when the "initial/communications protect" parameter is set to 0 or 1.

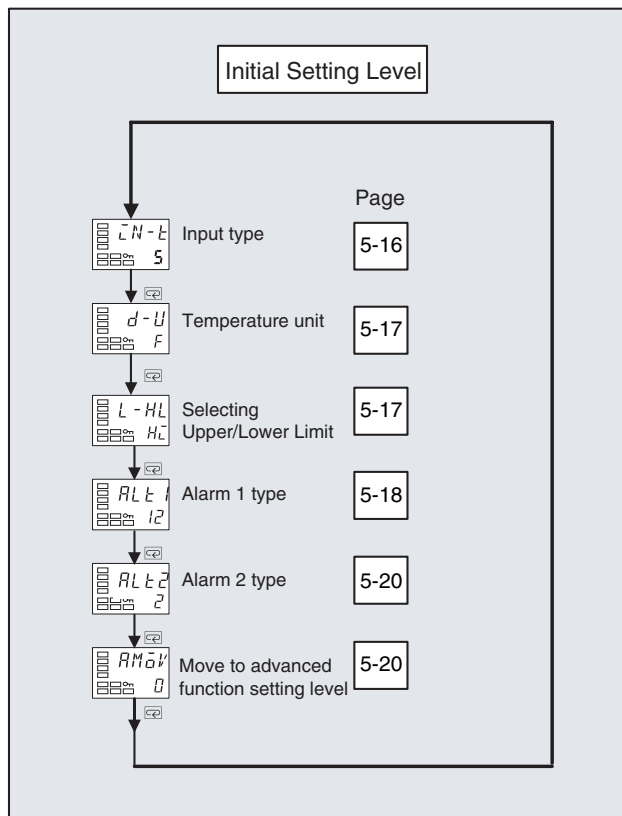

LN-E

Input Type



Function



Setting

- This parameter sets the type of sensor.
- When this parameter is changed, the limit setting value is initialized.
- Set one of the set values from the following table.
- The default setting is 5 (K thermocouple).
- If a platinum resistance thermometer is mistakenly connected while a setting for other than a platinum resistance thermometer is in effect, *S.ERR* will be displayed. To clear the *S.ERR* display, check the wiring and then cycle the power.

	Input type	Specifications	Set value	Input temperature range
Control- lers with Thermo- couple/ Resis- tance Ther- mometer Multi- inputs	Platinum resis- tance thermome- ter	Pt100	0	-200 to 850 (°C)/-300 to 1,500 (°F)
			1	-199.9 to 500.0 (°C)/-199.9 to 900.0 (°F)
			2	0.0 to 100.0 (°C)/0.0 to 210.0 (°F)
		JPt100	3	-199.9 to 500.0 (°C)/-199.9 to 900.0 (°F)
			4	0.0 to 100.0 (°C)/0.0 to 210.0 (°F)
		Thermocouple	K	5
	6			-20.0 to 500.0 (°C)/0.0 to 900.0 (°F)
	J		7	-100 to 850 (°C)/-100 to 1,500 (°F)
			8	-20.0 to 400.0 (°C)/0.0 to 750.0 (°F)
	T		9	-200 to 400 (°C)/-300 to 700 (°F)
			10	-199.9 to 400.0 (°C)/-199.9 to 700.0 (°F)
	E		11	0 to 600 (°C)/0 to 1,100 (°F)
	L		12	-100 to 850 (°C)/-100 to 1,500 (°F)
	U		13	-200 to 400 (°C)/-300 to 700 (°F)
			14	-199.9 to 400.0 (°C)/-199.9 to 700.0 (°F)
	N		15	-200 to 1,300 (°C)/-300 to 2,300 (°F)
	R		16	0 to 1,700 (°C)/0 to 3,000 (°F)
	S		17	0 to 1,700 (°C)/0 to 3,000 (°F)
	B		18	100 to 1,800 (°C)/300 to 3,200 (°F)
	Infrared Ther- mosensor ES1B	10 to 70 (°C)	19	0 to 90 (°C)/0 to 190 (°F)
		60 to 120 (°C)	20	0 to 120 (°C)/0 to 240 (°F)
		115 to 165 (°C)	21	0 to 165 (°C)/0 to 320 (°F)
160 to 260 (°C)		22	0 to 260 (°C)/0 to 500 (°F)	

See

Related Parameters

Temperature unit (initial setting level): Page 5-17

d-U Temperature Unit



Function

- Set the temperature input unit to either °C or °F.



Setting

Setting range	Default
°C: °C, °F: °F	°F



See

Related Parameters

Input type (initial setting level): Page 5-16

L-HL Selecting Upper/Lower Limit



Function

This parameter sets whether the limit function operates as an upper-limit function or lower-limit function.



Setting

Setting range	Default
$H\bar{L}$: Upper limit	$H\bar{L}$
$L\bar{a}$: Lower limit	

RLT 1

Alarm 1 Type

Alarm 1 must be assigned.



Function



Setting

- Select one of the following three alarm 1 types:
Deviation, Deviation range, or Absolute value

Set values	Alarm type	Alarm output operation	
		When alarm value X is positive	When alarm value X is negative
0	Alarm function OFF	Output OFF	
1	Upper- and lower-limit		See note 2.
2 (See note 1.)	Upper-limit		
3	Lower-limit		
4 (See note 1.)	Upper- and lower-limit range		See note 3.
5 (See note 1.)	Upper- and lower-limit with standby sequence		See note 4.
6	Upper-limit with standby sequence		
7	Lower-limit with standby sequence		
8	Absolute-value upper-limit		
9	Absolute-value lower-limit		
10	Absolute-value upper-limit with standby sequence		
11	Absolute-value lower-limit with standby sequence		
12	Annunciator	See page 3-12.	

Note 1. With set values 1, 4 and 5, the upper- and lower- limit values can be set independently for each alarm type, and are expressed as "L" and "H."

Note 2. Set value: 1 (Upper- and lower-limit alarm)

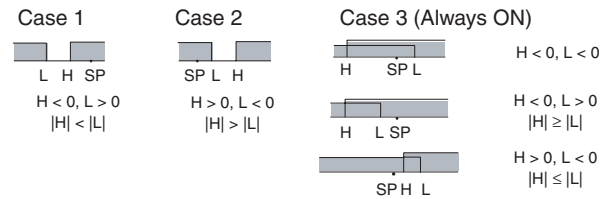

Note 3. Set value: 4 (Upper/Lower limit range)

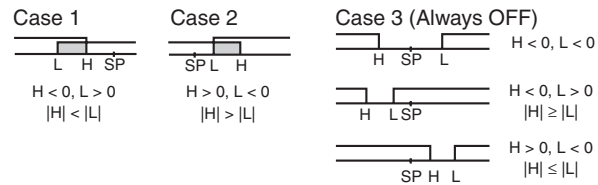

Note 4. Set value: 5 (Upper- and lower-limit with standby sequence)

- For the lower-limit alarms in cases 1 and 2 above, the alarm is normally OFF if upper- and lower-limit hysteresis overlaps.
- In case 3, the alarm is always OFF.

Note 5. Set value: 5 (The alarm is always OFF if upper- and lower-limit alarm hysteresis with standby sequence overlaps.)

- The default value is 12 (Annunciator alarm).

Related Parameters

Alarm value 1: Page 5-10, Alarm value upper limit 1, Alarm value lower limit 1: Page 5-11 (adjustment level)

Standby sequence reset: Page 5-23, Alarm 1 open in alarm: Page 5-24, Alarm 1 hysteresis: Page 5-25, Alarm 1 latch: Page 5-27 (advanced function setting level)

See

RLt2**Alarm 2 Type**

Alarm 2 must be assigned.



Function



Setting



- Select one of the following three alarm 2 types:
Deviation, Deviation range, or Absolute value
- Refer to the alarm 1 type list.
- The default value is 2 (Upper-limit alarm).

Related Parameters

Alarm value 2: Page 5-11, Alarm value upper limit 2, Alarm value lower limit 2: Page 5-12 (adjustment level)

Standby sequence reset: Page 5-23, Alarm 2 open in alarm: Page 5-24, Alarm 2 hysteresis: Page 5-25, Alarm 2 latch: Page 5-27 (advanced function setting level)



RM0V**Move to Advanced Function Setting Level**

The “initial setting/communications protect” parameter must be set to 0.



Function



- Set the “move to advanced setting level” parameter set value to “-169.”
- Move to the advanced setting level either by pressing the  key or  key or by waiting for two seconds to elapse.



Related Parameter

Initial setting/communications protect (protect level): Page 5-4

5.6 Advanced Function Setting Level

The advanced function setting level is used to optimize the Limit Controller's performance. To move to this level, input the password (“-169”) from the initial setting level.

To be able to enter the password, the “initial setting/communications protect” parameter in the protect level must be set to 0.

- The parameters in this level can be used when the “initial setting/communications protect” parameter is set to 0.
- To switch between setting levels, press the  key.
- To change set values, press the  and  keys.

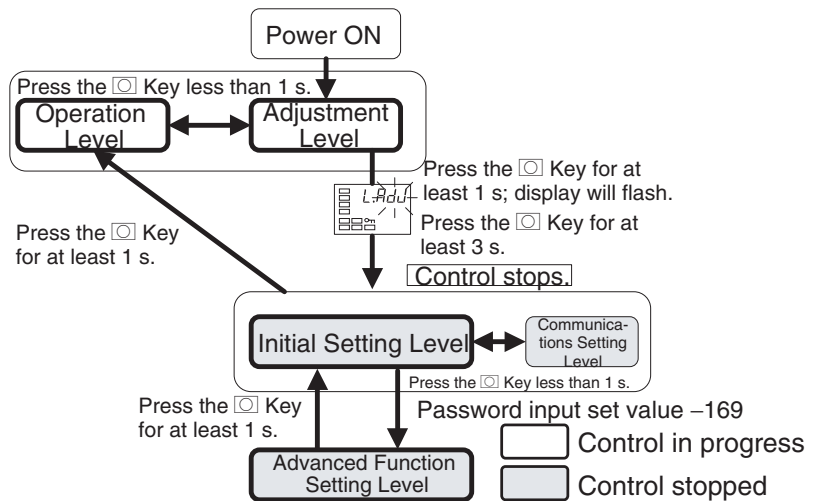

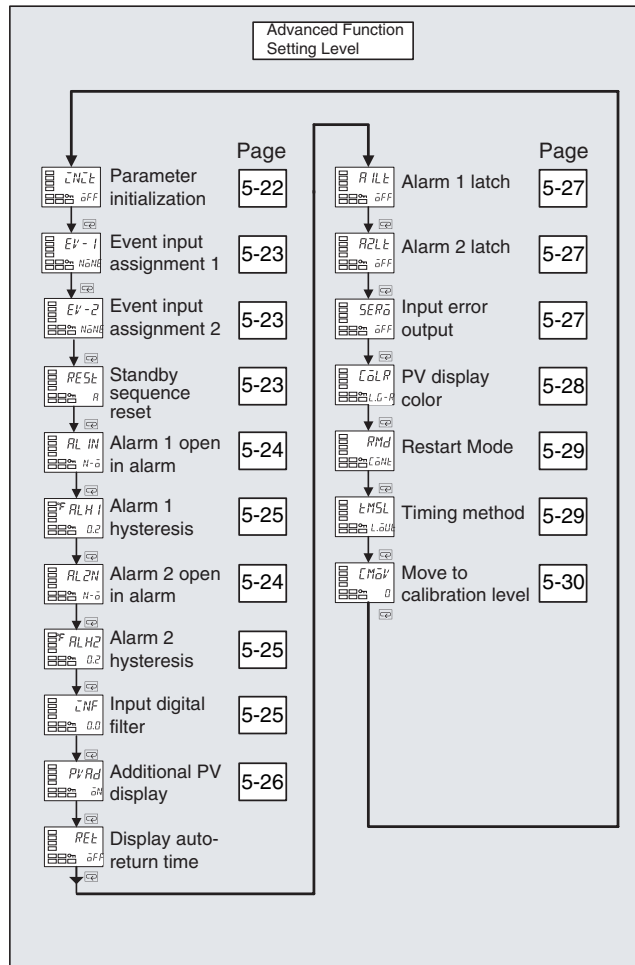

INIT

Parameter Initialization



Function



Setting

- This parameter returns all parameter settings to their defaults.
- After the initialization, the set value automatically turns OFF.

Setting range	Default
OFF: Initialization is not executed.	OFF
INIT: Initializes to the factory settings described in the manual.	

EV-1
EV-2

Event Input Assignment 1
Event Input Assignment 2

Event inputs must be supported.



- An external input can be used to reset the limit output or clear the limit over continuation time and limit over minimum/maximum value.
- Defaults: *NONE*



Setting item	Set value	Settings
Event input assignment 1 (EV-1) or Event input assignment 2 (EV-2)	<i>NONE</i>	None
	<i>RSET</i>	Reset limit output
	<i>HCLR</i>	Clear the limit over continuation time and limit over minimum/maximum value.

RSET

Standby Sequence Reset

The alarm 1 or 2 type must be set to a type with a standby sequence.



- This parameter selects the conditions for enabling reset after the standby sequence of the alarm has been canceled.
- Output is turned OFF when switching to the initial setting level, communications setting level, advanced function setting level, or calibration level.
- Condition A
When control started (including initial operation after power was turned ON), the limit setting value changed and the alarm value (including alarm value upper/lower limit) or input shift value (upper/lower-limit temperature input shift value) changed as well.
- Condition B
Power ON
- The following example shows the reset action when the alarm type is lower-limit alarm with standby sequence.

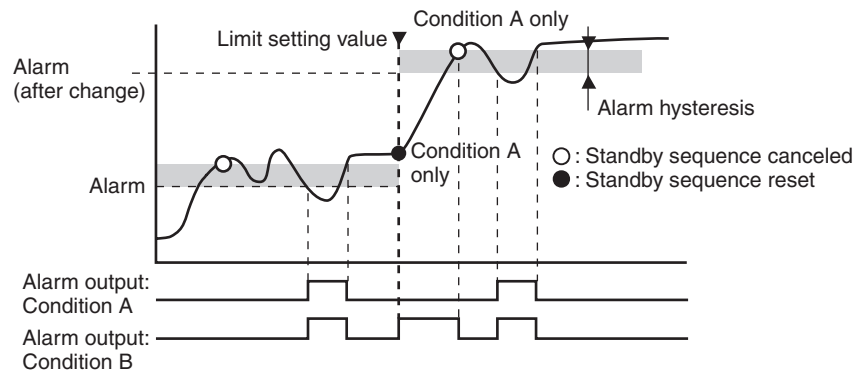



Setting range	Default
\bar{A} : Condition A, b : Condition B	\bar{A}

See

• **Related Parameters**

- Alarm 1 to 2 type (initial setting level): Page 5-18 to 5-20
- Alarm 1 to 2 latch (advanced function setting level): Page 5-27

RL IN
RL 2N

Alarm 1 Open in Alarm
Alarm 2 Open in Alarm

Alarm 1 must be assigned.

Alarm 2 must be assigned.



- These parameters set the output status for alarm 1 and alarm 2 settings.
- When the "alarm 1 open in alarm" parameter is set to "open in alarm," the input error output is also set to "open in alarm."
- When "close in alarm" is set, the status of the alarm output function will be output as is. When "open in alarm" is set, the status of the alarm output function will be reversed before being output. The following table shows the relationship between alarm output functions, alarm output and output LCDs.

	Alarm output operation	Alarm output	Output LCDs
Close in alarm	ON	ON	Lit
	OFF	OFF	Not lit
Open in alarm	ON	OFF	Lit
	OFF	ON	Not lit



Setting range	Default
$N-\bar{a}$: Close in alarm, $N-\bar{c}$: Open in alarm	$N-\bar{a}$

See

Related Parameters

Alarm value 1 and 2: Page 5-10 to 5-11, Alarm value upper limit 1 and 2, Alarm value lower limit 1 and 2: Page 5-11 to 5-12 (operation level), Alarm 1 and 2 type (initial setting level): Page 5-18 to 5-20, Standby sequence reset: Page 5-23, Alarm 1 and 2 hysteresis: Page 5-25, Alarm 1 and 2 latch: Page 5-27 (advanced function setting level)

ALH1**Alarm 1 Hysteresis**

Alarm 1 must be assigned and the alarm 1 type must not be 0 or 12.

ALH2**Alarm 2 Hysteresis**

Alarm 2 must be assigned and the alarm 2 type must not be 0 or 12.



Function



Setting

- These parameters set the alarm 1 and 2 hysteresis.

Setting range	Unit	Default
0.1 to 999.9	°C or °F	0.2



See

Related Parameters

Alarm value 1 and 2: Page 5-10 to 5-11, Alarm value upper limit 1 and 2, Alarm value lower limit 1 and 2: Page 5-11 to 5-12 (adjustment level), Alarm 1 and 2 type (initial setting level): Page 5-18 to 5-20, Standby sequence reset: Page 5-23, Alarm 1 and 2 open in alarm: Page 5-24, Alarm 1 and 2 latch: Page 5-27 (advanced function setting level)

INF**Input Digital Filter**

Function



Setting

- This parameter sets the time constant for the input digital filter. The following diagram shows the effect on data after passing through the digital filter:

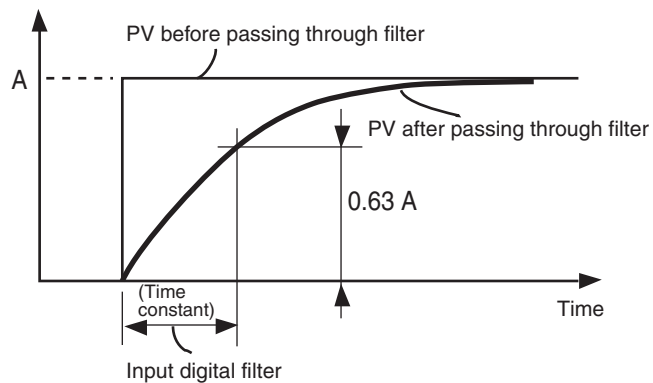

Setting range	Unit	Default
0.0 to 999.9	Second	0.0

PV R_d **Additional PV Display**

Function



Setting

This parameter specifies whether or not to add a PV display to the operation level's limit setting value (monitor) display.

Turn this parameter ON for a PV/Limit Setting Value display or OFF for the Limit Setting Value only display.

Setting range	Default
$\bar{O}N$: PV/Limit setting value display $\bar{O}FF$: Limit setting value display	$\bar{O}N$

RE_t **Automatic Display Return Time**

Function



Setting

- When the Controller is in the operation level or adjustment level and no keys have been pressed for the time set for this parameter, the display automatically returns to the PV/Limit Setting Value display or Limit Setting Value display.
- The automatic display return time is disabled when the parameter is set to OFF. (In that case, the display will not be automatically switched.)

Setting range	Unit	Default
OFF, 1 to 99	Second	$\bar{O}FF$

A1L \bar{L} **Alarm 1 Latch**

Alarm 1 must be assigned and the alarm 1 type must not be 0 or 12.

A2L \bar{L} **Alarm 2 Latch**

Alarm 2 must be assigned and the alarm 2 type must not be 0 or 12.



Function

- When a parameter is set to ON, once the alarm function has turned ON it is held until the power is turned OFF. The latch can be canceled, however, by switching to the initial setting level, communications setting level, advanced function setting level, or calibration level.
- If alarm outputs are set to “close in alarm,” the outputs are kept closed. If they are set to “open in alarm,” they are kept open.



Setting

Setting range	Default
$\bar{a}N$: Enabled, $\bar{a}FF$: Disabled	$\bar{a}FF$



See

Related Parameters

Alarm value 1 and 2: Page 5-10 to 5-11, Alarm value upper limit 1 and 2, Alarm value lower limit 1 and 2: Page 5-11 to 5-12 (adjustment level), Alarm 1 and 2 type (initial setting level): Page 5-18 to 5-20, Standby sequence reset: Page 5-23, Alarm 1 and 2 open in alarm: Page 5-24, Alarm 1 and 2 hysteresis: Page 5-25 (advanced function setting level)

SER \bar{a} **Input Error Output**

Alarm 1 must be assigned.



Function

- When this parameter is set to ON, alarm 1 output turns ON for input errors.
The alarm 1 operation indicator will not light.
- The alarm 1 output is an OR output of alarm 1 and input error.
- Output is turned OFF when switching to the initial setting level, communications setting level, advanced function setting level, or calibration level.



Setting

Setting range	Default
$\bar{a}N$: Enabled, $\bar{a}FF$: Disabled	$\bar{a}FF$

[aLR

PV Change Color



Function

- Use the PV color change function to change the color of the PV display (No. 1 display).
- There are two display colors, red and green, and you can select from the following three modes and six types.
- Constant: This mode displays red or green all the time.
- Linked to Alarm 1: This mode switches the PV display color from red to green when alarm 1 turns ON or from green to red when alarm 1 turns ON.
- Linked to Limit Status: This mode switches the PV display color between red and green depending on the limit status.
- The default setting is $L.G-R$ (Green \rightarrow Red).

The following table shows the display functions that can be set using the PV color change function.



Setting

Mode	Setting	Indicator color	Function
Fixed display	REd	Red	Always red
	GRN	Green	Always green
Linked to alarm 1	$R.R-G$	Red to Green	Green when ALM1 indicator is lit.
	$R.G-R$	Green to Red	Red when ALM1 indicator is lit.
Linked to limit status	$L.R-G$	Red to Green	Green when limit status is ON.
	$L.G-R$	Green to Red	Red when limit status is ON.

RMD**Restart Mode**

Function



Setting

- This parameter specifies the operation of the limit output after the power is turned ON.

Set value	Operation
<i>L_{ONL}</i>	The output status is determined by the relationship between the limit setting value and the process value when the power is turned ON. (See note.) Operation when an upper limit is used: Limit output OFF when $PV \geq SP$ Limit output ON when $PV < SP$
<i>SE_{OP}</i>	When the power is turned ON, the Controller always starts with the limit output OFF. The Controller can be put into alarm status by resetting the limit output.

Note: If the power was interrupted when the limit alarm was ON (limit output OFF), that alarm status will be maintained the next time that power is turned ON and the Controller will start with the limit alarm ON (limit output OFF).

LMSL**Timing Method**

Function



Setting

- This parameter sets the timing method used to calculate the limit over continuation time.

Set value	Operation
<i>L_{OUT}</i>	<ul style="list-style-type: none"> • Measures the time that the limit alarm is ON (limit output OFF). • Timing will continue while the limit alarm is ON (limit output OFF), even if the limit status returned to OFF.
<i>L_{STS}</i>	<ul style="list-style-type: none"> • Measures the time that the limit status is ON.

[Mö]

Move to Calibration Level



Initial setting/communications protect must be 0.



Function



This parameter sets the password to move to the calibration level.

- Set the password to move to the calibration level. The password is 1201.
- Move to the calibration level either by pressing the  key or  key or by waiting for two seconds to elapse.

Related Parameter

Initial setting/communications protect (protect level): Page 5-15

5.7 Communications Setting Level

<i>PSEL</i>	Protocol Setting	Communications must be supported.
<i>U-Nō</i>	Communications Unit No.	
<i>bPS</i>	Communications Baud Rate	
<i>LEN</i>	Communications Data Length	CompoWay/F must be selected as the protocol.
<i>SbċĒ</i>	Communications Stop Bits	CompoWay/F must be selected as the protocol.
<i>PRĒY</i>	Communications Parity	
<i>SdWĒ</i>	Send Data Wait Time	



Function



Setting

- Each parameter is enabled when the power is reset.
- Match the communications specifications of the E5CN-FR Limit Controller and the host computer. If multiple devices are connected, ensure that the communications specifications for all devices in the system (except the Communications unit number) are the same.

Item	Symbol	Set values	Settings	Default
Protocol setting	<i>PSEL</i>	<i>ĒWF, Mōd</i>	CompoWay/F, Modbus	<i>ĒWF</i>
Communications Unit No.	<i>U-Nō</i>	0 to 99	0 to 99	<i>1</i>
Communications baud rate	<i>bPS</i>	1.2, 2.4, 4.8, 9.6, 19.2, or 38.4 (kbit/s)	1.2, 2.4, 4.8, 9.6, 19.2, or 38.4 (kbit/s)	<i>9.6</i>
Communications data length	<i>LEN</i>	7, 8 (bit)	7, 8 (bit)	<i>7</i>
Stop bits	<i>SbċĒ</i>	1, 2	1, 2	<i>2</i>
Communications parity	<i>PRĒY</i>	<i>NōNE, EVĒN, ādd</i>	None, Even, Odd	<i>EVĒN</i>
Send data wait time	<i>SdWĒ</i>	0 to 99	0 to 99 (ms)	<i>20</i>

See

Related Parameter

Communications writing (adjustment level): Page 5-14

SECTION 6 CALIBRATION

This section explains how to calibrate the Limit Controller.

6.1	Parameter Structure	6-2
6.2	User Calibration	6-4
	Calibrating Inputs.....	6-4
	Registering Calibration Data.....	6-4
6.3	Thermocouple Calibration	6-5
	Preparations	6-5
6.4	Platinum Resistance Thermometer Calibration	6-8
6.5	Checking Indication Accuracy.....	6-10
	Thermocouple or Infrared Temperature Sensor ..	6-10
	Platinum Resistance Thermometer	6-10

6.1 Parameter Structure

- To execute user calibration, enter the password “1201” at the “move to calibration level” parameter in the advanced function setting level. The mode will be changed to the calibration mode, and *RdU* will be displayed.
- The “move to calibration level” parameter may not be displayed when the user is doing the calibration for the first time. If this happens, set the “initial/communications protect” parameter in the protect level to 0 before moving to the advanced function setting level.
- The calibration mode is ended by turning the power OFF.
- The parameter calibrations in the calibration mode are structured as shown in the following diagram.

Controllers with Thermocouple/Resistance Thermometer Multi-inputs

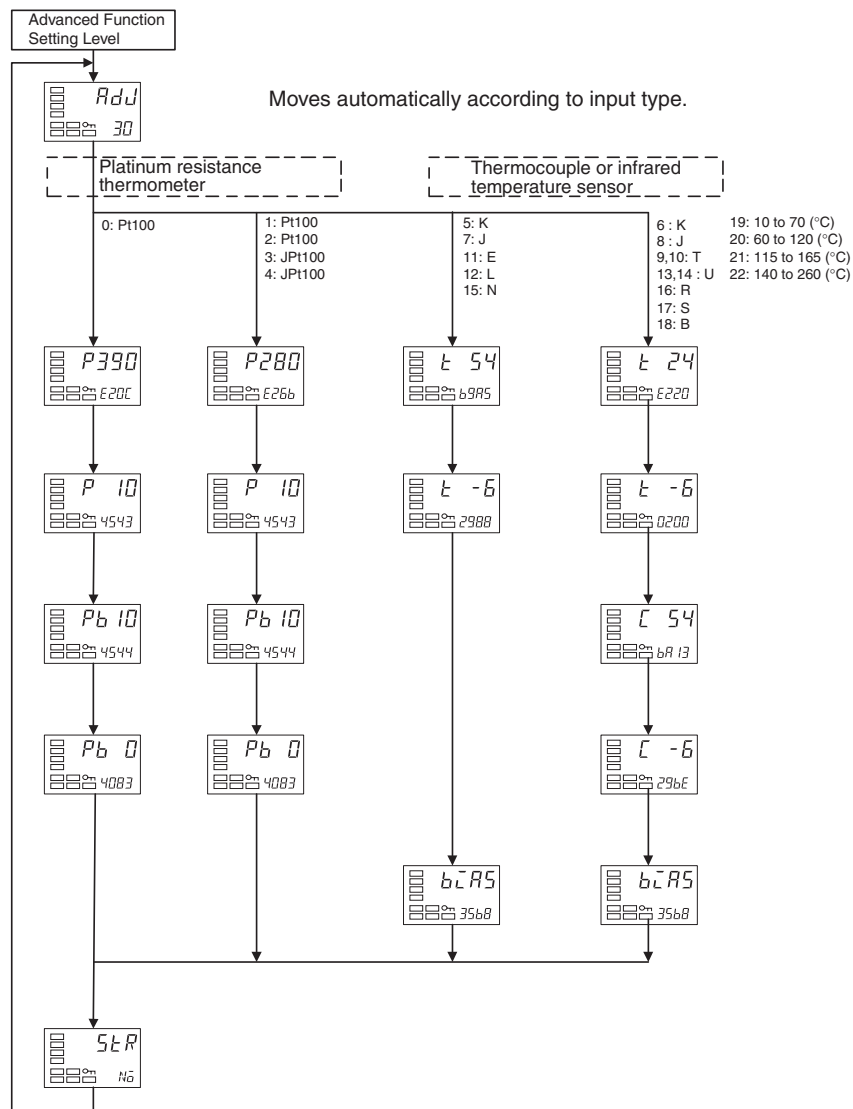

When calibration has been performed after purchase, the user calibration information shown in the following illustration will be displayed when moving to the calibration level.

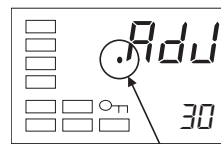

A dot is displayed.

6.2 User Calibration

The E5CN-FR Limit Controller is correctly calibrated before it is shipped from the factory, and normally need not be calibrated by the user.

If the Controller must be calibrated by the user, use the user-calibration function provided to calibrate the temperature input. OMRON, however, cannot ensure the results of calibration by the user. Also, calibration data is overwritten with the latest calibration results. The default calibration settings cannot be restored after user calibration. Perform user calibration with care.

● Calibrating Inputs

The input type selected in the parameter is used for calibration. The input types are as follows:

- Thermocouple: 14 types
- Infrared temperature sensor: 4 types
- Platinum resistance thermometer: 5 types

● Registering Calibration Data

The new calibration data for each item is temporarily registered. It can be officially registered as calibration data only when all items have been calibrated to new values. Therefore, be sure to temporarily register all items when you perform the calibration. When the data is registered, it is also recorded that user calibration has been performed.

Prepare separate measuring devices and equipment for calibration. For details on how to handle measuring devices and equipment, refer to the respective instruction manuals.

6.3 Thermocouple Calibration

- Calibrate according to the type of thermocouple: thermocouple 1 group (input types 5, 7, 11, 12, 15) and thermocouple 2 group (input types 6, 8, 9, 10, 13, 14, 16, 17, 18, 19, 20, 21, 22).
- When calibrating, do not cover the bottom of the Controller. Also, do not touch input terminals (terminals 4 and 5 on the E5CN-FR) or the compensating conductors.

● Preparations

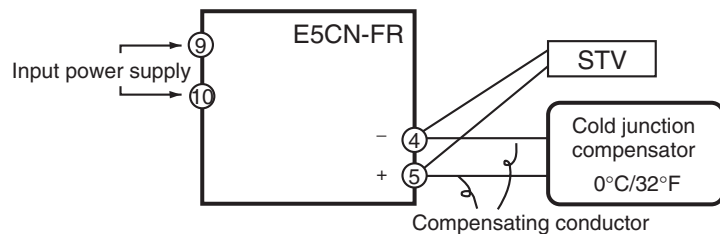

- Set the cold junction compensator designed for compensation of internal thermocouples to 0°C. Make sure that internal thermocouples are disabled (i.e., that tips are open).
- In the above figure, STV indicates a standard DC current/voltage source.
- Use the compensating conductor designed for the selected thermocouple. When thermocouples R, S, E, or B or an infrared temperature sensor is used, the cold junction compensator and the compensating conductor can be substituted with the cold junction compensator and the compensating conductor for thermocouple K.

Connecting the Cold Junction Compensator

Correct process values cannot be obtained if you touch the contact ends of the compensating conductor during calibration of a thermocouple. Accordingly, short-circuit (enable) or open (disable) the tip of the thermocouple inside the cold junction compensator as shown in the figure below to create a contact or non-contact state for the cold junction compensator.

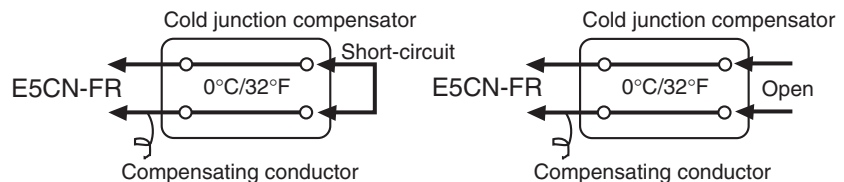

The following example shows how to calibrate the temperature input when the input type is set to thermocouple or infrared temperature sensor.

1. Connect the power supply.
2. Connect a standard DC current/voltage source (STV), precision digital multimeter (DMM), and contact junction compensator (e.g., a zero controller as in the figure) to the thermocouple input terminals, as shown in the figure below.

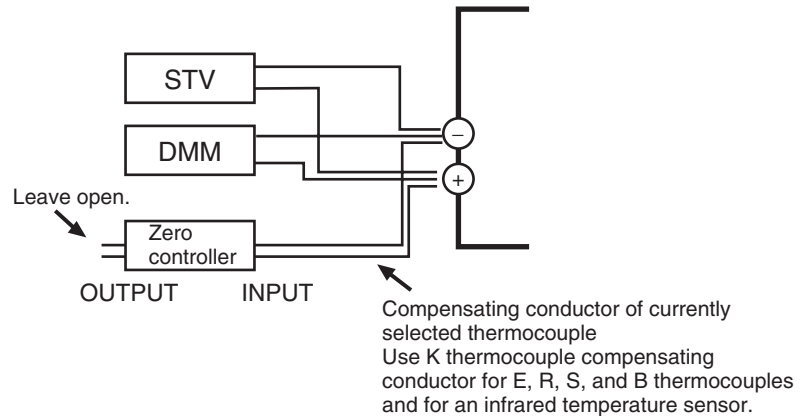

3. Turn the power ON.

4. Move to the calibration level.

This starts the 30-minute aging timer. This timer provides an approximate timer for aging. After 30 minutes have elapsed, the No. 2 display changes to 0. You can advance to the next step in this procedure even if 0 is not displayed.

5. When the key is pressed, the status changes as shown to the left.

The No. 2 display at this time shows the currently entered count value in hexadecimal. Set the STV as follows:

- Input types 5, 7, 11, 12, 15: Set to 54 mV.
 - Input types 6, 8, 9, 10, 13, 14, 16, 17, 18, 19, 20, 21, 22: Set to 24 mV.
- Allow the count value on the No. 2 display to fully stabilize, then press the key to temporarily register the calibration settings.

If this count value is outside of the specified range, the No. 2 display will flash and the count value will not be temporarily registered.

6. When the key is pressed, the status changes as shown to the left.

Set the STV to -6 mV.

Allow the count value on the No. 2 display to fully stabilize, then press the key to temporarily register the calibration settings.

If this count value is outside of the specified range, the No. 2 display will flash and the count value will not be temporarily registered.

7. Press the key. The display changes as shown on the left for input types 6, 8, 9, 10, 13, 14, 16, 17, 18, 19, 20, 21, and 22. Set the STV to 54 mV. Allow the count value on the No. 2 display to fully stabilize, then press the key to temporarily register the calibration settings.

If this count value is outside of the specified range, the No. 2 display will flash and the count value will not be temporarily registered.



Input types 5, 7, 11, 12, 15:

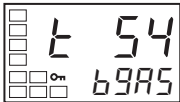

Input types 6, 8, 9, 10, 13, 14, 16, 17, 18, 19, 20, 21, 22:

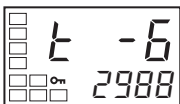
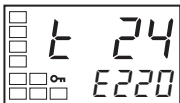

Input types 6, 8, 9, 10, 13, 14, 16, 17, 18, 19, 20, 21, and 22 only:

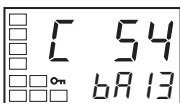

Input types 6, 8, 9, 10, 13, 14, 16, 17, 18, 19, 20, 21, and 22 only:

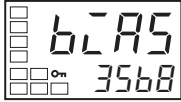
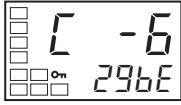

8. Press the key. The display changes as shown on the left for input types 6, 8, 9, 10, 13, 14, 16, 17, 18, 19, 20, 21, and 22. Set the STV to -6 mV. Allow the count value on the No. 2 display to fully stabilize, then press the key to temporarily register the calibration settings.

If this count value is outside of the specified range, the No. 2 display will flash and the count value will not be temporarily registered.

9. When the key is pressed, the status changes as shown to the left.

10. Change the wiring as follows:

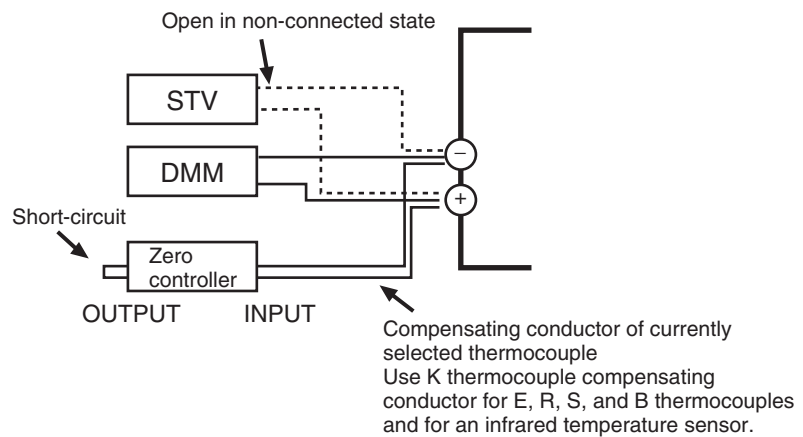

Disconnect the STV to enable the thermocouple of the cold junction compensator. When doing this, be sure to disconnect the wiring on the STV side.

11. Allow the count value on the No. 2 display to fully stabilize, then press the key to temporarily register the calibration settings.

12. When the key is pressed, the status changes as shown to the left.

The data to be temporarily registered is not displayed if it is not complete.

Press the key. The No. 2 display changes to $4E5$. Release the key and wait two seconds or press the key. This stores the temporarily registered calibration data to EEPROM. To cancel the saving of temporarily registered calibration data to EEPROM, press the key (while $N\bar{0}$ is displayed in the No. 2 display) without pressing the key.

13. The calibration mode is ended by turning the power OFF.

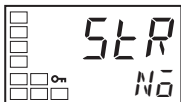

6.4 Platinum Resistance Thermometer Calibration

The following example shows how to calibrate the temperature input when the input type is set to a resistance thermometer.

Use connecting wires of the same wire material and thickness.

1. Connect the power supply.
2. Connect a precision resistance box (called a “6-dial” in this manual) to the platinum resistance thermometer input terminals, as shown in the following diagram.

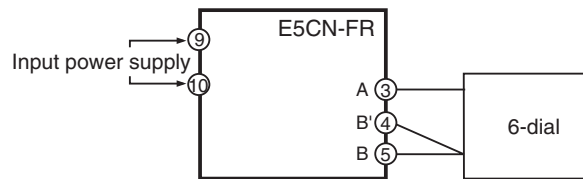

3. Turn the power ON.
4. Move to the calibration level.

This starts the 30-minute aging timer. This timer provides an approximate timer for aging. After 30 minutes have elapsed, the No. 2 display changes to 0. You can advance to the next step in this procedure even if 0 is not displayed.

5. Execute calibration for the main input.

Press the key to display the count value for each input type.

The No. 2 display at this time shows the currently entered count value in hexadecimal. Set the 6-dial as follows:

- Input type 0: 390 Ω
- Input type 1, 2, 3 or 4: 280 Ω

Allow the count value on the No. 2 display to fully stabilize, then press the key to temporarily register the calibration settings.

If this count value is outside of the specified range, the No. 2 display will flash and the count value will not be temporarily registered.

6. When the key is pressed, the status changes as shown to the left.

Set the 6-dial to 10 Ω .

Allow the count value on the No. 2 display to fully stabilize, then press the key to temporarily register the calibration settings.

If this count value is outside of the specified range, the No. 2 display will flash and the count value will not be temporarily registered.

7. Next calibrate the B-B' input.

Change the connections as follows:

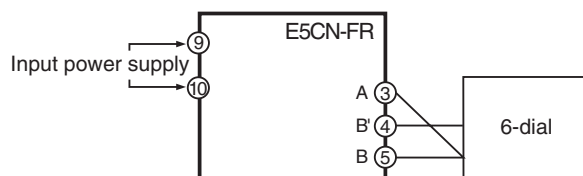

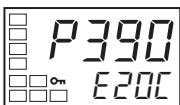

Input type 0:

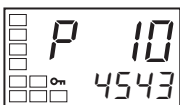
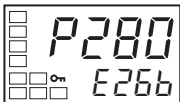

Input types 1, 2, 3, 4:

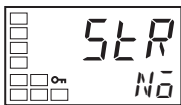
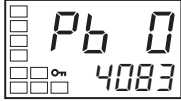
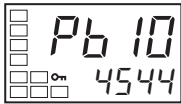





- 8.** When the  key is pressed, the status changes as shown to the left.
Set the 6-dial to 10 Ω.

Allow the count value on the No. 2 display to fully stabilize, then press the  key to temporarily register the calibration settings.

If this count value is outside of the specified range, the No. 2 display will flash and the count value will not be temporarily registered.

- 9.** When the  key is pressed, the status changes as shown to the left.
Short-circuit the 6-dial terminals to set 0 Ω.



* The 6-dial terminals must be short-circuited, because it is otherwise impossible to set 0 Ω for the 6-dial.



Allow the count value on the No. 2 display to fully stabilize, then press the  key to temporarily register the calibration settings.

If this count value is outside of the specified range, the No. 2 display will flash and the count value will not be temporarily registered.

- 10.** When the  key is pressed, the status changes as shown to the left.

The data to be temporarily registered is not displayed if it is not complete.

Press the  key. The No. 2 display changes to 5E5. Release the key and wait two seconds or press the  key. This stores the temporarily registered calibration data to EEPROM.

To cancel the saving of temporarily registered calibration data to EEPROM, press the  key (while No is displayed in the No. 2 display) without pressing the  key.

- 11.** The calibration mode is quit by turning the power OFF.

6.5 Checking Indication Accuracy

- After calibrating the input, be sure to check the indication accuracy to make sure that the calibration has been executed correctly.
- Operate the E5CN-FR in the process value/limit setting value monitor mode.
- Check the indication accuracy at the following three values: upper limit, lower limit, and mid-point.

● Thermocouple or Infrared Temperature Sensor

- Preparations

The diagram below shows the required device connections. Make sure that the E5CN-FR and cold junction compensator are connected by a compensating conductor for the thermocouple that is to be used during actual operation.

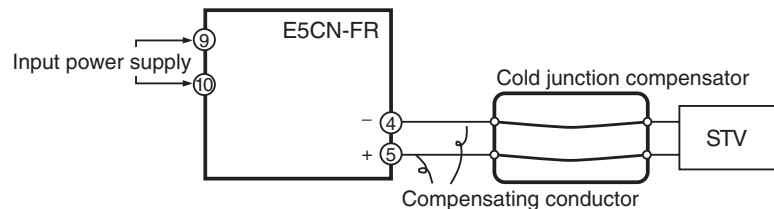

- Operation

Make sure that the cold junction compensator is at 0°C, and set the STV output to the voltage equivalent of the starting power of the check value.

● Platinum Resistance Thermometer

- Preparations

The diagram below shows the required device connections.

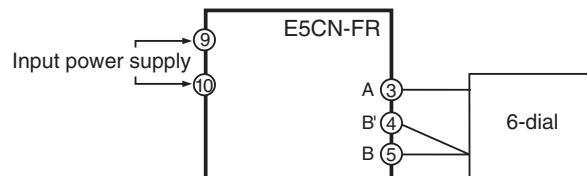

- Operation

Set the 6-dial to the resistance equivalent to the check value.

Appendix

Specifications.....	A-2
Ratings	A-2
Characteristics	A-3
Error Displays	A-4
Parameter Operation Lists	A-6
Sensor Input Setting Range, Indication Range, Control Range.....	A-11
Setting Levels Diagram.....	A-13

Specifications

■ Ratings

Supply voltage	100 to 240 VAC, 50/60 Hz	
Operating voltage range	85 to 110% of rated supply voltage	
Power consumption	7.5 VA max. (E5CN-FR2T: 3.0 VA at 100 VAC)	
Sensor input (See note.)	Thermocouple: K, J, T, E, L, U, N, R, S, B Platinum resistance thermometer: Pt100, JPt100 Infrared temperature sensor: 10 to 70°C, 60 to 120°C, 115 to 165°C, 140 to 260°C	
Control output	Relay output	R output: SPST-NO, 250 VAC, 3A (resistive load), electrical life: 100,000 operations Min. applicable load: 5 V, 10 mA
Alarm output	SPST-NO, 250 VAC, 1 A (resistive load), electrical life: 100,000 operations Min. applicable load: 1 V, 1 mA	
Setting method	Digital setting using front panel keys	
Indication method	11-segment digital display and single-LED indicator	
Other functions	Depend on the model	
Ambient temperature	-10 to 55°C (with no condensation or icing); with 3-year guarantee: -10 to 50°C	
Ambient humidity	25% to 85%	
Storage temperature	-25 to 65°C (with no condensation or icing)	
Altitude	2,000 m or less	
Recommended fuse	T2A, 250 VAC, time lag, low shut-off capacity	
Installation environment	Installation Category II, Pollution Class 2 (IEC 61010-1 compliant)	

Note: For the setting ranges for each sensor input, see page A-11.

● External Power Supply for ES1B

Output voltage	12 VDC \pm 10%
Output current	20 mA max.

Note: Contact your OMRON representative for information on using the external power supply for ES1B for other applications.

■ Characteristics

Indication accuracy	Thermocouple (See note.): (±0.5% of indication value or ±1°C, whichever is greater) ±1 digit max. Platinum resistance thermometer: (±0.5% of indication value or ±1°C, whichever is greater) ±1 digit max.		
Hysteresis	0.1 to 999.9°C or °F (in units of 0.1°C or °F)		
Alarm setting range	-1,999 to 9,999 (decimal point position depends on input type)		
Sampling period	250 ms		
Insulation resistance	20 MΩ min. (at 500 VDC)		
Dielectric strength	2,000 VAC, 50/60 Hz for 1 min between terminals of different charge		
Malfunction vibration	10 to 55 Hz, 20 m/s ² for 10 min each in X, Y and Z directions		
Vibration resistance	10 to 55 Hz, double-amplitude of 0.75 mm for 2 hr each in X, Y, and Z directions		
Malfunction shock	100 m/s ² , 3 times each in X, Y, and Z directions		
Shock resistance	300 m/s ² , 3 times each in X, Y, and Z directions		
Weight	Controller: Approx. 150 g	Adapter: approx. 10 g	Terminal cover: approx. 10 g
Protective structure	Front panel: NEMA4X for indoor use (equivalent to IP66), rear case: IP20, terminals: IP00		
Memory protection	EEPROM (non-volatile memory) (number of writes: 1,000,000)		

Note: The indication of K thermocouples in the -200 to 1,300°C range, T and N thermocouples at a temperature of -100°C or less, and U and L thermocouples at any temperature is ±2°C ±1 digit maximum. The indication of B thermocouples at a temperature of 400°C or less is not specified. The indication of R and S thermocouples at a temperature of 200°C or less is ±3°C ±1 digit maximum.

Error Displays

When an error occurs, the error contents are shown on the No. 1 display.

This section describes how to check error codes on the display, and the actions to be taken to remedy the problems.

Input Error

● Meaning

The input type setting is incorrect or the input wiring is incorrect, disconnected, or short-circuited.

● Action

Check the wiring of inputs for miswiring, disconnections, and short-circuits and check the input type.

If no abnormality is found in the wiring and input type, turn the power OFF then back ON again.

If the display remains the same, the Controller must be replaced. If the display is restored, then the probable cause is electrical noise affecting the control system. Check for electrical noise.

● Operation at Error

After an error occurs, the error is displayed and the alarm outputs function as if the upper limit has been exceeded. When the “input error output” parameter in the advanced function level is set to ON, the alarm 1 output turns ON whenever an input error occurs.

Lower Limit of Display Range Exceeded

Upper Limit of Display Range Exceeded

● Meaning

The input value has exceeded the control range. (See note.)

Note: Control range

Resistance thermometer or thermocouple input: Temperature setting lower limit -20°C to temperature setting upper limit $+20^{\circ}\text{C}$

(Temperature setting lower limit -40°F to temperature setting upper limit $+40^{\circ}\text{F}$)

ES1B input: Same as input indication range

The following table shows the limit output and alarm output operation when an error occurs.

Error	Internal PV	Limit output		Alarm output
Lower Limit of Display Range Exceeded	Below indication range	Upper limit operation	Normal operation	Operating at abnormally low temperature
		Lower limit operation	OFF (Limit status ON)	
Upper Limit of Display Range Exceeded	Above indication range	Upper limit operation	OFF (Limit status ON)	Operating at abnormally high temperature
		Lower limit operation	Normal operation	

CCCC**Display Range Exceeded (Lower Limit of Display Range)****● Meaning**

An error will not occur, but the PV will not be displayed when the display range is exceeded.

● Action

Control continues, allowing normal operation. The PV/Limit setting value display will be displayed if the PV/Limit setting value display has been selected.

E111**Memory Error****● Meaning**

Internal memory operation is in error.

● Action

First, turn the power OFF then back ON again. If the display remains the same, the Controller must be repaired. If the display is restored, then the probable cause is electrical noise affecting the control system. Check for electrical noise.

● Operation at Error

The limit output and alarm outputs turn OFF.

Parameter Operation Lists

● Operation Level (Monitor Only)

Parameters	Characters	Setting (monitor) value	Display	Default	Unit
Process value		Sensor input indication range			EU
Limit Setting Value		Lower limit of input setting range to upper limit of input setting range		0	EU
Limit Over Continuation Time	<i>L_{IME}</i>	0.00 to 99.59			Hours. Minutes
Limit Over Maximum Value	<i>P-H_L</i>	Sensor input indication range			EU
Limit Over Minimum Value	<i>P-L_o</i>	Sensor input indication range			EU

● Adjustment Level

Parameters	Characters	Setting (monitor) value	Display	Default	Unit
Adjustment level display	<i>L.AdJ</i>				
Limit Setting Value	<i>SP-S</i>	Lower limit of input setting range to upper limit of input setting range		0	EU
Alarm Value 1	<i>RL-1</i>	-1,999 to 9,999		0	EU
Alarm Value Upper Limit 1	<i>RL1H</i>	-1,999 to 9,999		0	EU
Alarm Value Lower Limit 1	<i>RL1L</i>	-1,999 to 9,999		0	EU
Alarm Value 2	<i>RL-2</i>	-1,999 to 9,999		0	EU
Alarm Value Upper Limit 2	<i>RL2H</i>	-1,999 to 9,999		0	EU
Alarm Value Lower Limit 2	<i>RL2L</i>	-1,999 to 9,999		0	EU
Temperature input shift	<i>LNS</i>	-199.9 to 999.9		0.0	°C or °F
Upper-limit temperature input shift value	<i>LNSH</i>	-199.9 to 999.9		0.0	°C or °F
Lower-limit temperature input shift value	<i>LNSL</i>	-199.9 to 999.9		0.0	°C or °F
Hysteresis	<i>HYS</i>	0.1 to 999.9		1.0	°C or °F
Communications Writing	<i>EMWE</i>	OFF, ON	<i>oFF, oN</i>	OFF	None

● Initial Setting Level

Parameters	Characters	Setting (monitor) value	Display	Default	Unit	
Input type	$\bar{N}-t$	Multi-input	0: Pt100		5	None
			1: Pt100			
			2: Pt100			
			3: JPt100			
			4: JPt100			
			5: K			
			6: K			
			7: J			
			8: J			
			9: T			
			10: T			
			11: E			
			12: L			
			13: U			
			14: U			
			15: N			
			16: R			
			17: S			
			18: B			
			19: 10 to 70°C			
			20: 60 to 120°C			
			21: 115 to 165°C			
22: 140 to 260°C						
Temperature unit	$d-U$	°C, °F	$^{\circ}C, ^{\circ}F$	°F	None	
Selecting Upper/Lower Limit	$L-HL$	HI: Upper limit operation LO: Lower limit operation	$H\bar{L}, L\bar{O}$	HI	None	

Parameters	Characters	Setting (monitor) value	Display	Default	Unit
Alarm 1 type	<i>AL1</i>	0: Alarm function OFF		12	None
		1: Upper and lower-limit alarm			
		2: Upper-limit alarm			
		3: Lower-limit alarm			
		4: Upper and lower-limit range alarm			
		5: Upper and lower-limit alarm with standby sequence			
		6: Upper-limit alarm with standby sequence			
		7: Lower-limit alarm with standby sequence			
		8: Absolute-value upper-limit alarm			
		9: Absolute-value lower-limit alarm			
		10: Absolute-value upper-limit alarm with standby sequence			
		11: Absolute-value lower-limit alarm with standby sequence			
12: Annunciator					
Alarm 2 type	<i>AL2</i>	Same settings as the alarm 1 type		2	None
Move to advanced function setting level	<i>AMV</i>	-1999 to 9,999		0	None

● Advanced Function Setting Level

Parameters	Characters	Setting (monitor) value	Display	Default	Unit
Parameter initialization	$\overline{CN}\overline{LE}$	OFF, FACT	\overline{OFF} , $FACT$	OFF	None
Event input assignment 1	$EV-1$	NONE (0): None RSET (1): Reset input HCLR (2): HCLR input	$NONE$, $RSET$, $HCLR$	NONE	None
Event input assignment 2	$EV-2$	NONE (0): None RSET (1): Reset input HCLR (2): HCLR input	$NONE$, $RSET$, $HCLR$	NONE	None
Standby sequence reset	$RSET$	Condition A, condition B	A , b	Condition A	None
Alarm 1 open in alarm	$ALIN$	N-O: Close in alarm N-C: Open in alarm	$N-\overline{O}$, $N-\overline{C}$	N-O	None
Alarm 1 hysteresis	$ALH1$	0.1 to 999.9		0.2	°C or °F
Alarm 2 open in alarm	$AL2N$	N-O: Close in alarm N-C: Open in alarm	$N-\overline{O}$, $N-\overline{C}$	N-O	None
Alarm 2 hysteresis	$ALH2$	0.1 to 999.9		0.2	°C or °F
Input digital filter	\overline{CNF}	0.0 to 999.9		0.0	Second
Additional PV display	$PVAd$	OFF, ON	\overline{OFF} , \overline{ON}	ON	None
Automatic display return time	REt	OFF or 1 to 99	\overline{OFF} , 1 to 99	OFF	Second
Alarm 1 latch	$AL1L$	OFF, ON	\overline{OFF} , \overline{ON}	OFF	None
Alarm 2 latch	$AL2L$	OFF, ON	\overline{OFF} , \overline{ON}	OFF	None
Input error output	$SERO$	OFF, ON	\overline{OFF} , \overline{ON}	OFF	None
PV change color	\overline{CLR}	RED, GRN, A.R-G, A.G-R, L.R-G, L.G-R	RED , GRN , $AR-G$, $AG-R$, $LR-G$, $LG-R$	L.G-R	None
Restart Mode	RMd	CONT: The output status is determined by the relationship between the limit setting value and the process value when the power is turned ON. STOP: The limit output is always OFF when the power is turned ON (can be cleared by resetting the limit output).	\overline{CONT} , $STOP$	CONT	None
Timing Method	$EMSL$	L.OUT: Times when the limit alarm is ON (limit output OFF). L.STS: Times when the limit status is ON.	$L.OUT$, $L.STS$	L.OUT	None
Move to calibration level	$EMOV$	-1999 to 9,999		0	None

● Protect Level

Parameters	Characters	Setting (monitor) value	Display	Default	Unit
Move to protect level	<i>PMōV</i>	-1999 to 9,999		0	None
Operation/adjustment protect	<i>ōRPŁ</i>	0 to 2		0	None
Initial setting/communications protect	<i>ŁŁPŁ</i>	0 to 2		1	None
Setting change protect	<i>WŁPŁ</i>	OFF, ON	<i>ōFF, ōN</i>	OFF	None
Password to move to protect level	<i>PRLP</i>	-1999 to 9,999		0	None

● Communications Setting Level

Parameters	Characters	Setting (monitor) value	Display	Default	Unit
Protocol setting	<i>PSEL</i>	CompoWay/F, Modbus	<i>ŁWF, Mōd</i>	Compo-Way/F	None
Communications Unit No.	<i>U-Nō</i>	0 to 99		1	None
Communications baud rate	<i>bPS</i>	1.2, 2.4, 4.8, 9.6, 19.2, or 38.4	<i>1.2, 2.4, 4.8, 9.6, 19.2, 38.4</i>	9.6	kbps
Communications data length	<i>LEN</i>	7, 8		7	Bit
Communications stop bits	<i>SbŁŁ</i>	1, 2		2	Bit
Communications parity	<i>PRŁY</i>	None, Even, Odd	<i>NōNE, EVEN, ōdd</i>	Even	None
Send data wait time	<i>SdWŁ</i>	0 to 99		20	ms

Sensor Input Setting Range, Indication Range, Control Range

	Input type	Specifications	Set value	Input temperature range	Input indication range
Con- trollers with Ther- mocou- ple/ Resis- tance Ther- mome- ter Multi- inputs	Resistance thermometer	Pt100	0	-200 to 850 (°C)/-300 to 1,500 (°F)	-220 to 870 (°C)/-340 to 1,540 (°F)
			1	-199.9 to 500.0 (°C)/-199.9 to 900.0 (°F)	-199.9 to 520.0 (°C)/-199.9 to 940.0 (°F)
			2	0.0 to 100.0 (°C)/0.0 to 210.0 (°F)	-20.0 to 120.0 (°C)/-40.0 to 250.0 (°F)
		JPt100	3	-199.9 to 500.0 (°C)/-199.9 to 900.0 (°F)	-199.9 to 520.0 (°C)/-199.9 to 940.0 (°F)
			4	0.0 to 100.0 (°C)/0.0 to 210.0 (°F)	-20.0 to 120.0 (°C)/-40.0 to 250.0 (°F)
		Thermocou- ple	K	5	-200 to 1,300 (°C)/-300 to 2,300 (°F)
	6			-20.0 to 500.0 (°C)/0.0 to 900.0 (°F)	-40.0 to 520.0 (°C)/-40.0 to 940.0 (°F)
	J		7	-100 to 850 (°C)/-100 to 1,500 (°F)	-120 to 870 (°C)/-140 to 1,540 (°F)
			8	-20.0 to 400.0 (°C)/0.0 to 750.0 (°F)	-40.0 to 420.0 (°C)/-40.0 to 790.0 (°F)
	T		9	-200 to 400 (°C)/-300 to 700 (°F)	-220 to 420 (°C)/-340 to 740 (°F)
			10	-199.9 to 400.0 (°C)/-199.9 to 700.0 (°F)	-199.9 to 420.0 (°C)/-199.9 to 740.0 (°F)
	E		11	0 to 600 (°C)/0 to 1,100 (°F)	-20 to 620 (°C)/-40 to 1,140 (°F)
	L		12	-100 to 850 (°C)/-100 to 1,500 (°F)	-120 to 870 (°C)/-140 to 1,540 (°F)
	U		13	-200 to 400 (°C)/-300 to 700 (°F)	-220 to 420 (°C)/-340 to 740 (°F)
			14	-199.9 to 400.0 (°C)/-199.9 to 700.0 (°F)	-199.9 to 420.0 (°C)/-199.9 to 740.0 (°F)
	N		15	-200 to 1,300 (°C)/-300 to 2,300 (°F)	-220 to 1,320 (°C)/-340 to 2,340 (°F)
	R		16	0 to 1,700 (°C)/0 to 3,000 (°F)	-20 to 1,720 (°C)/-40 to 3,040 (°F)
	S	17	0 to 1,700 (°C)/0 to 3,000 (°F)	-20 to 1,720 (°C)/-40 to 3,040 (°F)	
B	18	100 to 1,800 (°C)/300 to 3,200 (°F)	0 to 1,820 (°C)/0 to 3,240 (°F)		

	Input type	Specifications	Set value	Input temperature range	Input indication range
Controllers with Thermocouple/Resistance Thermometer Multi-inputs	ES1B Infra-red Thermosensor	10 to 70°C	19	0 to 90 (°C)/0 to 190 (°F)	-20 to 130 (°C)/-40 to 270 (°F)
		60 to 120°C	20	0 to 120 (°C)/0 to 240 (°F)	-20 to 160 (°C)/-40 to 320 (°F)
		115 to 165°C	21	0 to 165 (°C)/0 to 320 (°F)	-20 to 205 (°C)/-40 to 400 (°F)
		140 to 260°C	22	0 to 260 (°C)/0 to 500 (°F)	-20 to 300 (°C)/-40 to 580 (°F)

- The default setting is 5.
- The applicable standards for each of the above input ranges are as follows:
K, J, T, E, N, R, S, B: JIS C1602-1995, IEC 584-1
L: Fe-CuNi, DIN 43710-1985
U: Cu-CuNi, DIN 43710-1985
JPt100: JIS C 1604-1989, JIS C 1606-1989
Pt100: JIS C 1604-1997, IEC 751

● Control Range

- Resistance thermometer and thermocouple input
Temperature lower limit - 20°C to temperature upper limit + 20°C, or temperature lower limit - 40°C to temperature upper limit + 40°C
- ES1B input:
Same as input indication range

Setting Levels Diagram

This diagram shows all of the setting levels. To move to the advanced function setting level and calibration level, you must enter passwords. Some parameters are not displayed depending on the protect level setting and the conditions of use.

Control stops when you move from the operation level to the initial setting level.

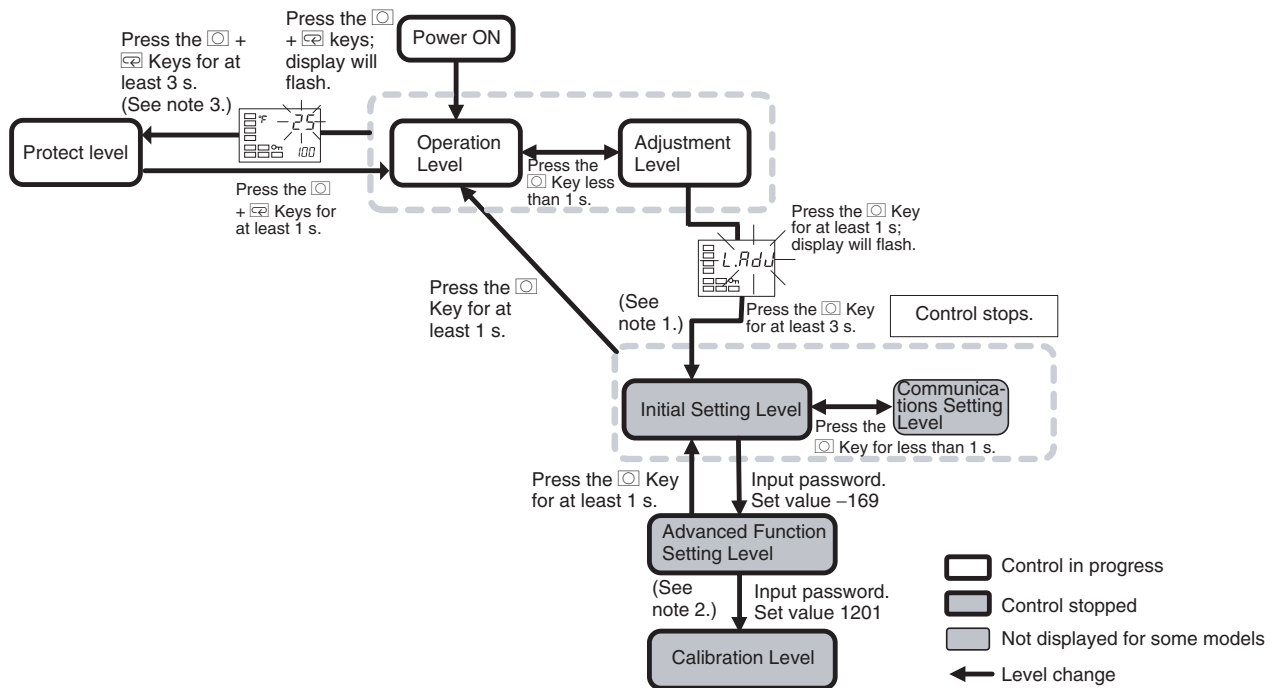

Note 1. Moves to operation level by software reset.

Note 2. It is not possible to move to other levels from the calibration level by operating the keys on the front panel. It can be done only by first turning OFF the power.

Note 3. The time taken to move to the protect level can be adjusted by changing the "Move to protect level time" setting.

Parameter Flow

This section describes the parameters set in each level. Pressing the  key at the last parameter in each level returns to the top parameter in that level.

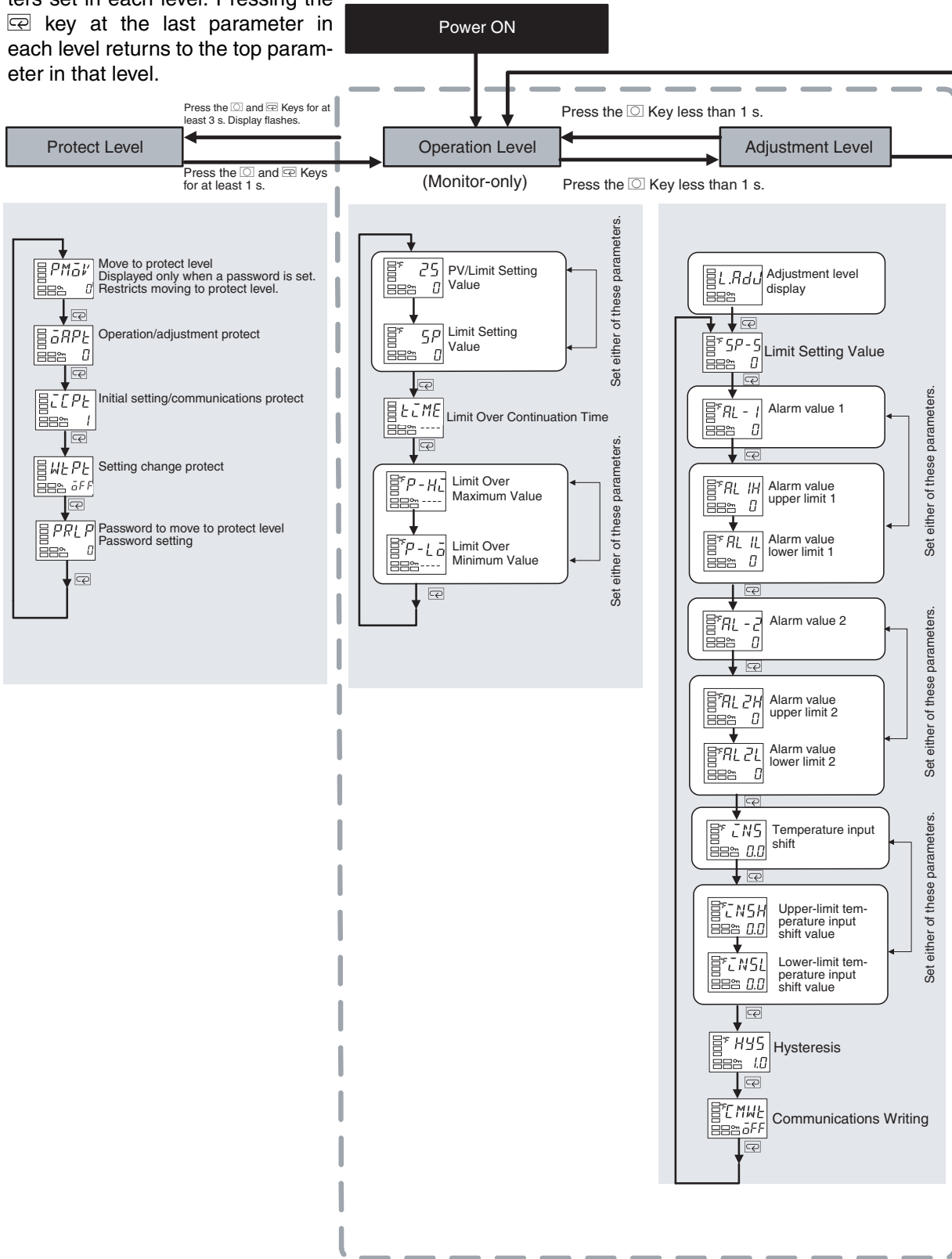

Press the  Key for at least 1 s.

Press the  Key for at least 3 s.

Press the  Key for at least 1 s.

Press the  Key for at least 1 s.

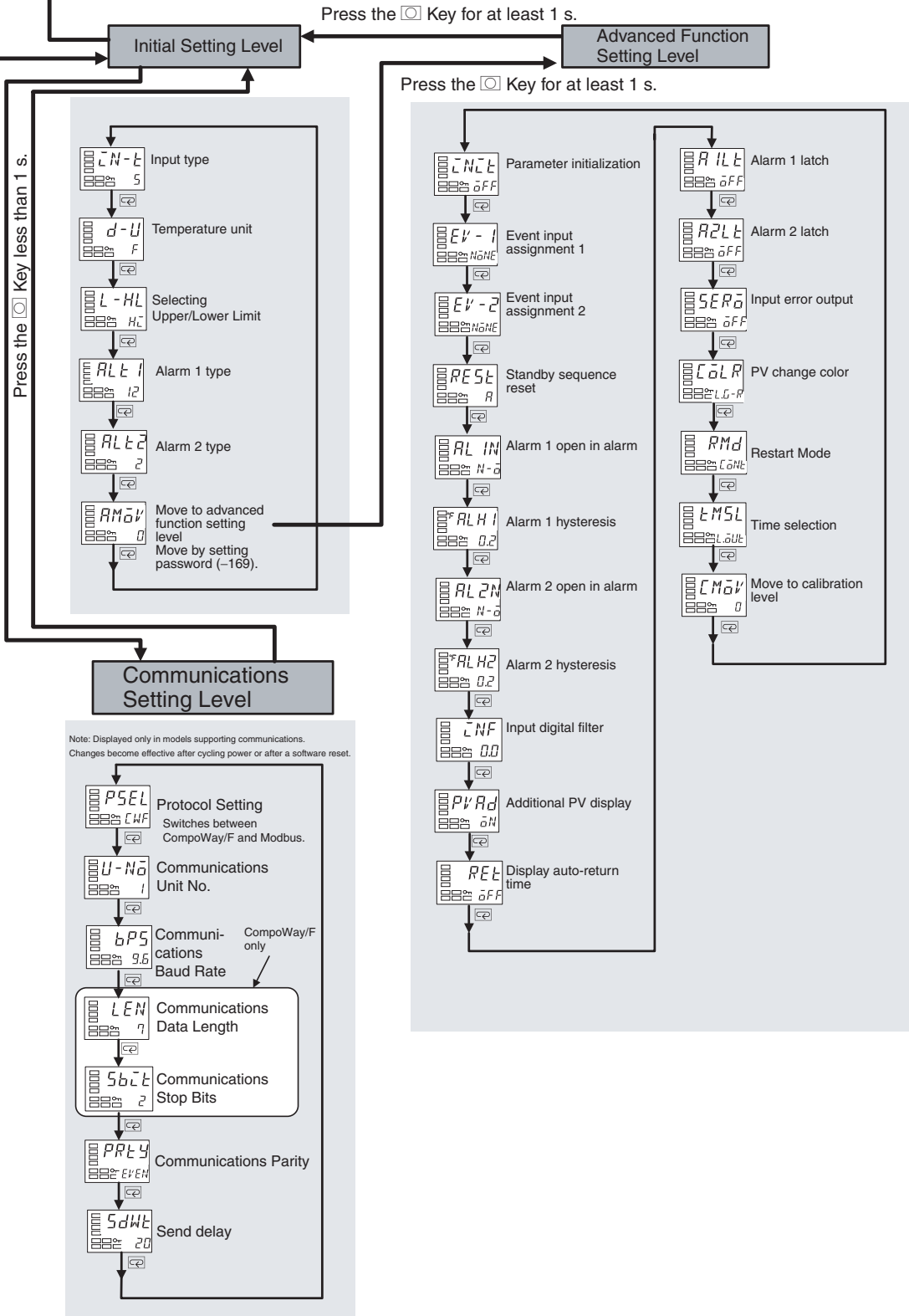



PART 2: Communications

SECTION 1

Communications Methods

This section introduces the supported communications methods and device wiring methods. Read and understand this section first in order to wire the devices correctly.

1.1	Overview of Communications Methods	1-2
	Introduction.....	1-2
	Communications Specifications.....	1-3
	Transmission Procedure.....	1-3
	Interface.....	1-4
	Wiring	1-4
	Communications Parameters	1-5
	Communications Parameter Setup	1-5
	Communications Parameters.....	1-6

1.1 Overview of Communications Methods

■ Introduction

The program for the communications functions are created on the host computer, and the E5CN-FR's parameters are monitored or set from the host computer. Therefore, the description provided here is from the viewpoint of the host computer.

CompoWay/F is OMRON's standard communications format for general serial communications. This format uses a standard frame format as well as the well-established FINS* commands used for OMRON's PLCs. Therefore, it can simplify communications between components and the host computer.

*FINS (Factory Interface Network service)

The FINS protocol provides message communications between controllers in OMRON FA networks.

Modbus is a standard communications control method that conforms to the Modicon Company's RTU-mode Modbus Protocol (PI-MBUS-300 Revision J). Supports functions equivalent to the CompoWay/F Read Variable Area, Write Variable Area, Operation Command, and Echoback Test functions.

The E5CN-FR supports the following communications functions.

- Reading/writing of parameters
- Operation instructions
- Selection of setup levels

Communications are subject to the following condition:

- Parameters can be written only when the "communications writing" parameter is set to ON (enabled).

■ Communications Specifications

Transmission line connection	RS-485: Multidrop
Communications method	RS-485 (2-wire, half-duplex)
Synchronization method	Start-stop synchronization
Communications baud rate (See note.)	1,200, 2,400, 4,800, 9,600 , 19,200 or 38,400 bps
Communications code	ASCII
Communications data bits (See note.)	7 or 8 bits
Communications stop bits (See note.)	1 or 2 bits
Error detection	Vertical parity (none, even or odd) BCC (Block Check Character) with CompoWay/F communications CRC-16 (Cyclic Redundancy Check 16) with Modbus communications
Flow control	None
Interface	RS-485
Retry function	None
Communications buffer	40 bytes
Send data wait time (See note.)	0 to 99 ms, default time: 20 ms

Note: Communications baud rate, data bits, stop bits, vertical parity, and send data wait time can each be set independently in the communications setting level. Highlighted values indicate default settings.

■ Transmission Procedure

When the host computer transmits a command frame, the E5CN-FR transmits a response frame that corresponds to the command frame. A single response frame is returned for each command frame. The following diagram shows the operation of the command and response frames.

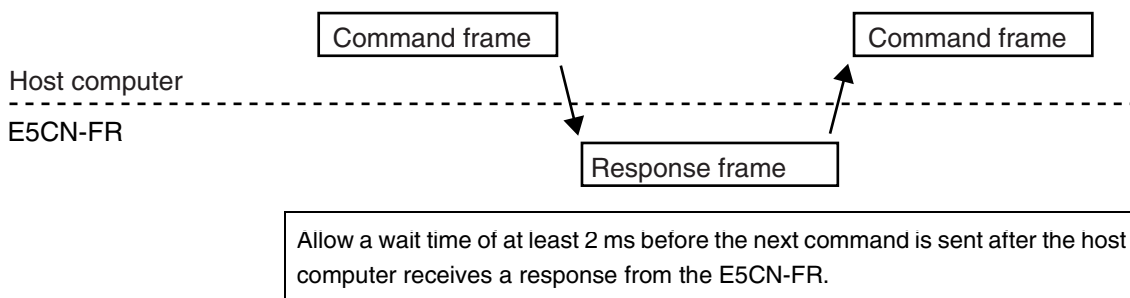

Interface

Communications with the host computer are carried out through a standard RS-485 interface. Use a K3SC Interface Converter for RS-485 interface conversion.

Wiring

RS-485

- The RS-485 connection can be either one-to-one or one-to-N. Up to 32 units including the host computer can be connected in a one-to-N system.
- The total cable length is 500 m max.
- Use a shielded twisted-pair cable with wires of a thickness of AWG24 (0.205 mm²) to AWG14 (2.081 mm²).

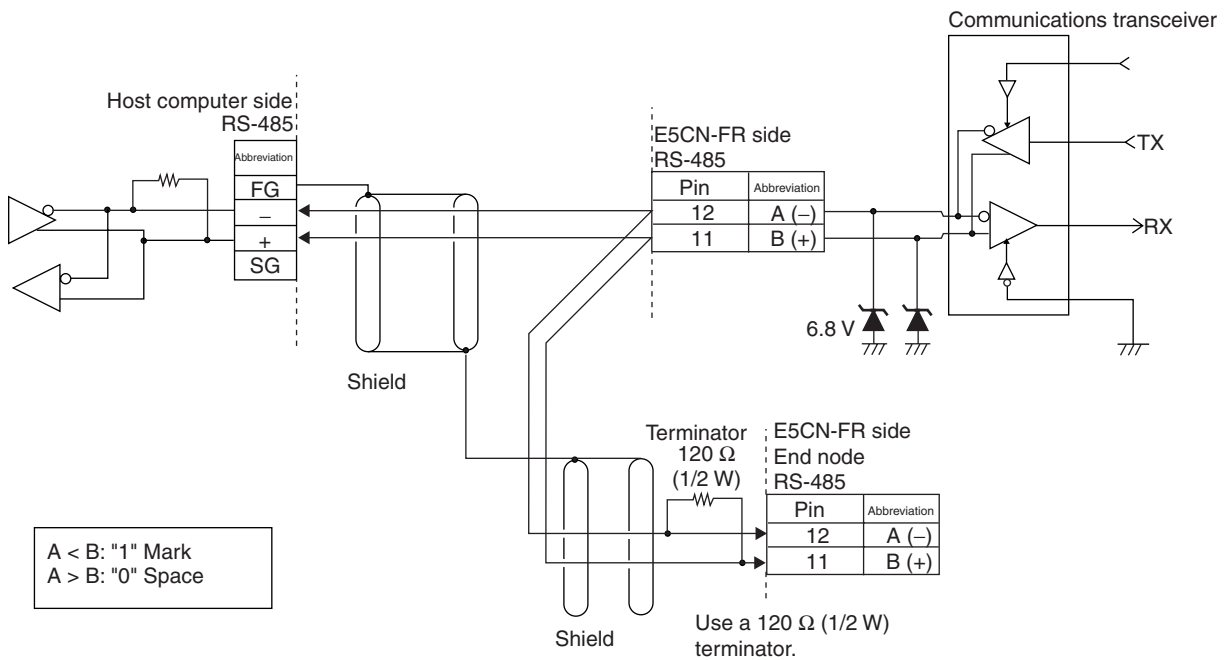

Specify both ends of the transmission path including the host computer as the end node (that is, connect terminators to both ends). Use a terminating resistance of at least 54 Ω.

Match the communications specifications of the E5CN-FR and the host computer. When using a 1: N connection, set the same communications specifications in all of the Units. (Of course, each Unit must have a unique unit number.)

This section explains how to set the E5CN-FR's communications specifications. For details on the host computer, refer to the User's Manual provided with the host computer.

■ Communications Parameters

The E5CN-FR's communications specifications are set in the communications setting level. These parameters are set on the E5CN-FR's front panel. The following table shows the communications parameters and their setting ranges.



Item	Code	Settings	Set Values
Communications protocol	<i>PSEL</i>	CompoWay/F/Modbus	CW/F /Mod
Communications unit number	<i>U-Nb</i>	0 to 99	0 1 to 99
Communications baud rate	<i>BPS</i>	1.2/2.4/4.8/9.6/19.2/38.4 (kbit/s)	1.2/2.4/4.8/ 9.6 /19.2/38.4 (kbit/s)
Communications data length	<i>LEN</i>	7/8 (bit)	7 /8 (bit)
Communications stop bits	<i>SBIT</i>	1/2	1/ 2
Communications parity	<i>PRTY</i>	None, Even, Odd	NONE/ EVEN /odd
Send data wait time	<i>SDWT</i>	0 to 99	0 to 99 ms, default time: 20 ms

Highlighted values indicate default settings.

● Communications Parameter Setup

Before you carry out communications with the E5CN-FR, set up the communications unit number, baud rate, and other parameters by carrying out the following procedure. For details on operations other than communications parameter setup, refer to the Operation Manuals for the devices being used.

1. Press the key to move from the operation level to the adjustment level.
2. Press the key for at least three seconds to move from the adjustment level to the initial setting level.
3. Press the key to move from the initial setting level to the communications setting level.
4. Select the parameters as shown below by pressing the key.

5. Press the  or  keys to change the parameter setting.

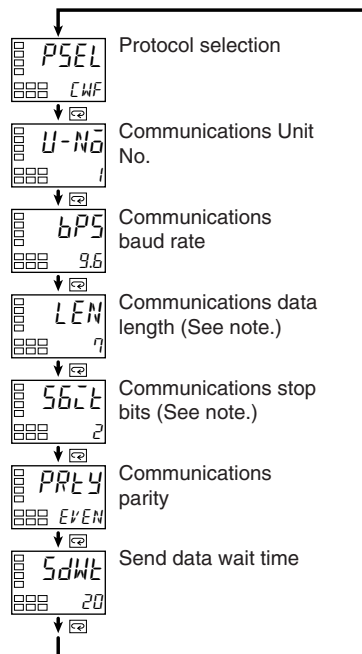

Note: Displayed only when the “Protocol selection” setting is set to CompoWay/F communications.

● Communications Parameters

When communications parameter settings have been changed, the new settings must be enabled by resetting the Controller.

- Protocol Selection (*PSEL*)
The communications protocol can be selected. Set CompoWay/F or Modbus.
- Communications Unit Number (*U-Nb*)
This parameter is for setting a unique unit number for each of the Limit Controllers. This unit number is set so that the host computer can identify the Limit Controller when communications are carried out with the host computer. The unit number can be set to an integer value between 0 and 99. The default is “1.” When two or more Limit Controllers are used, do not set the same unit number. Doing so will prevent normal operation.
- Communications Baud Rate (*bPS*)
Sets the baud rate for communications with the host computer. The communications baud rate settings are as follows: 1.2 (1,200 bps), 2.4 (2,400 bps), 4.8 (4,800 bps), 9.6 (9,600 bps), 19.2 (19,200 bps), and 38.4 (38,400 bps)
- Communications Data Length (*LEN*)
This parameter is for setting the number of communications data bits. Set either “7 bits” or “8 bits.”

- Communications Stop Bits (*Sb̄t*)
This parameter is for setting the number of communications stop bits. Set either “1” or “2.”
- Communications Parity (*PR̄t*)
The communications parity can be set. Set the parity to “N̄ONE,” “EV̄EN,” or “ōdd.”
- Send Data Wait Time (*Sd̄wt*)
The send data wait time can be set in 1-ms increments between 0 and 99 ms. The default is 20 ms.

SECTION 2

CompoWay/F Communications Procedures

Read this section when using CompoWay/F communications to perform operations from a host computer, such as reading/writing variable area data or sending operation commands.

2.1	Data Format.....	2-2
	Command Frame.....	2-2
	BCC Calculation Example.....	2-3
	Response Frame.....	2-3
	Communications Data.....	2-4
	End Code Example.....	2-4
2.2	Structure of Command Text.....	2-6
	PDU Structure.....	2-6
	Area Definitions.....	2-6
	Type Code (Variable Type).....	2-7
	Addresses.....	2-7
	Number of Elements.....	2-7
	List of Services.....	2-8
2.3	Detailed Description of the Services.....	2-9
	Read Variable Area.....	2-9
	Write Variable Area.....	2-10
	Read Controller Attributes.....	2-12
	Read Controller Status.....	2-13
	Echoback Test.....	2-14
	Operation Command.....	2-15
2.4	Response Code List.....	2-18

2.1 Data Format

Hexadecimal values are expressed by adding the prefix H' before the number, e.g., H'02. Numbers shown without the H' prefix are ASCII characters.

The number underneath each item in a frame indicates the number of bytes.

■ Command Frame

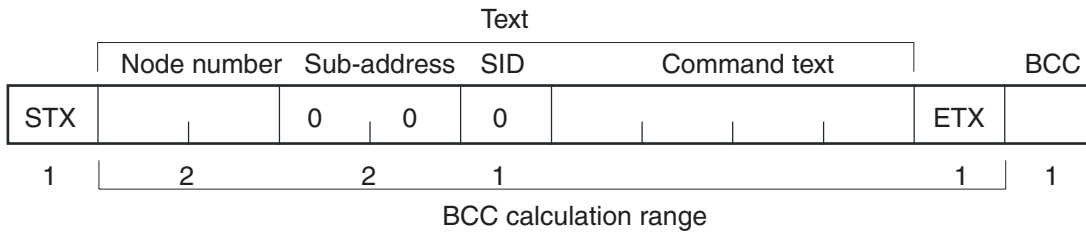

STX	This code (H'02) indicates the beginning of the communications frame (text). Always set this character in the first byte. When STX is received again during reception, reception is carried out again from the point where STX was received.
Node number	<ul style="list-style-type: none"> • This number specifies the transmission's destination. • Specify the E5CN-FR's communications unit number. • A BCD value between 00 and 99 or an ASCII value of XX can be set. • Specify "XX" for a broadcast transmission. No responses will be returned for broadcast transmissions. • No responses will be returned from node numbers other than the ones in the above range.
Sub-address	The sub-address is not used in the E5CN-FR. Be sure to set the sub-address to "00."
SID (Service ID)	The service ID is not used in the E5CN-FR. Be sure to set the service ID to "0."
Command text	This is the command text area. For details, see <i>2.2 Structure of Command Text</i> .
ETX	This code (H'03) indicates the end of the text.
BCC	This is the Block Check Character. The BCC result is found by calculating the exclusive OR of the bytes from the node number up to ETX.

● BCC Calculation Example

The BCC (Block Check Character) is determined by calculating the exclusive OR of the bytes from the node number up to ETX. The 8-bit result is written to the BCC byte at the end of the frame.

STX	Node number	Sub-address	SID	Command text	ETX	BCC
02H	0 (30H)	0 (30H)	0 (30H)	0 (30H) 5 (35H) 0 (30H) 3 (33H)	03H	35H

$BCC = 30H \oplus 30H \oplus 30H \oplus 30H \oplus 30H \oplus 30H \oplus 35H \oplus 30H \oplus 33H \oplus 03H = 35H$
 The result of the calculation (35 hex) is written to the BCC byte.

The ⊕ symbols indicate XOR (exclusive OR) operations.

■ Response Frame

STX	Node number	Sub-address	End code	Command text	ETX	BCC
	0	0				
1	2	2	2		1	1

End code	Name	Description	Error detection priority
00	Normal completion	The command ended normally without error.	None
0F	FINS command error	The specified FINS command could not be executed. The FINS response code should indicate why the command could not be executed.	8
10	Parity error	The sum total of bits whose received data is "1" does not match the set value of the "communications parity" bit.	2
11	Framing error	Stop bit is "0."	1
12	Overrun error	An attempt was made to transfer new data when the reception data buffer was already full.	3
13	BCC error	The calculated BCC value is different from the received BCC value.	5
14	Format error	<ul style="list-style-type: none"> The command text contains characters other than 0 to 9, and A to F. This error does not apply to Echoback Tests. (Refer to the Echoback Test for details.) There was no SID and command text. There was no command text. "MRC/SRC" not included in command text. 	7
16	Sub-address error	<ul style="list-style-type: none"> Illegal (unsupported) sub-address There was no sub-address, SID, and command text. Sub-address was less than two characters, and there was no SID and command text 	6
18	Frame length error	The received frame exceeds the specified (supported) number of bytes.	4

- An end code is returned for each command frame received that was addressed to the local node.
- No response will be returned unless the frame contained all elements up to the ETX and BCC.
- "Error Detection Priority" indicates the priority when two or more errors occur simultaneously.

■ Communications Data

Communications format	Set (monitor) values	Negative values	Decimal point
CompoWay/F	8-digit hexa-decimal	2's complement	Decimal point is removed and the result is converted to hexadecimal. Example conversion: 105.0 → 1050 → H'0000041A

■ End Code Example

The following examples show the end code when a command did not end normally.

Example 1) Illegal Sub-address, No SID, and No Command Text
Command

	Node number	Sub-address	BCC
STX		0 A	EXT

Response

	Node number	Sub-address	End code	BCC
STX		0 A	1 6	EXT

End code is "16" (sub-address error).

The sub-address error code is used because the sub-address error has a higher error detection priority than the format error.

Example 2) No Command Text
Command

	Node number	Sub-address	SID	BCC
STX		0 0	0	EXT

Response

	Node number	Sub-address	End code	BCC
STX		0 0	1 4	EXT

The end code is "14" (format error).

Example 3) No Node Number Provided
Command

	BCC
STX	EXT

The node number is lacking one character.

Response

There is no response.

Example 4) No Sub-address and Illegal BCC

Command

Node number		BCC	
STX		EXT	Err

Response

Node number		Sub-address		End code		BCC	
STX		0	0	1	3	EXT	

The sub-address is "00" and the end code is "13" (BCC error).

2.2 Structure of Command Text

■ PDU Structure

An MRC (Main Request Code) and SRC (Sub-Request Code) followed by the various required data is transferred to the command text.

Service Request PDU



The MRES (Main Response Code) and SRES (Sub-Response Code) are transferred to the response frame following the above MRC/SRC. Data is then transferred following the MRES and SRES.

Service Response PDU (Normal Response)



If the specified command text could not be executed, the service response PDU will contain only the MRC/SRC and MRES/SRES.

Service Response PDU (Command Text Not Executed)



The MRES and SRES become the response code when processing did not end in "normal completion."

■ Area Definitions

Areas comprise only the variable area.

■ Type Code (Variable Type)

The following tables show the variable area type codes.

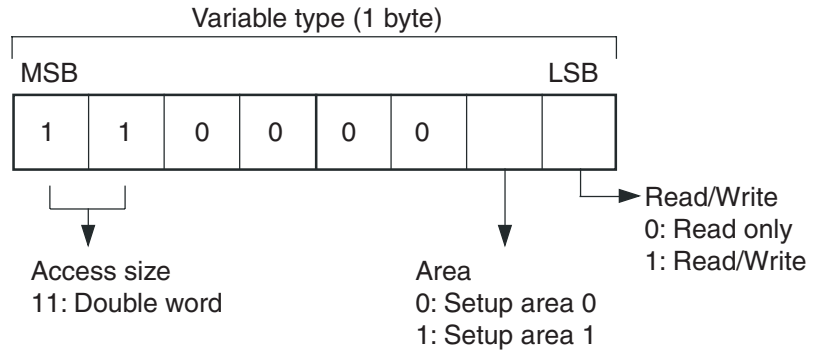

The following table summarizes setup areas 0 and 1.

Area	Description
Setup area 0	This area groups together the protect, operation, and adjustment levels.
Setup area 1	This area groups together the initial setting, communications setting, advanced function setting, and calibration levels.

The variable type is converted to 2-byte ASCII and loaded to the frame.

The following table shows the available variable types.

Variable type	Description
C0	Double-word data. R/O (read only) parameter for setup area 0.
C1	Double-word data. R/W parameter for setup area 0.
C3	Double-word data. R/W parameter for setup area 1.

* Setup area 1 has no read-only parameters, so there is no variable type "C2."

■ Addresses

An address is appended to each of the variable types. Express addresses in 2-byte hexadecimal and append them for the specified access size.

■ Number of Elements

The number of elements is expressed in 2-byte hexadecimal. Specify the number of elements within the range "0 to 2."

For example, when the number of elements is "0002," this specifies two items of data from the address.

■ List of Services

MRC	SRC	Name of service	Processing
01	01	Read Variable Area	This service reads from variable areas.
01	02	Write Variable Area	This service writes to variable areas.
05	03	Read Controller Attributes	This service reads the model number and communications buffer size.
06	01	Read Controller Status	This service reads the operating status.
08	01	Echoback Test	This service performs an echoback test.
30	05	Operation Command	This service performs operations such as enabling/disabling communications writing and moving to Setup Area 1.

* No commands will be accepted and no responses will be returned when a memory error (RAM error) has occurred or the Controller is initializing (until the Controller recognizes the process value after the power is turned ON).

2.3 Detailed Description of the Services

■ Read Variable Area

This service reads data from a variable area.

Service Request PDU

MRC	SRC	Variable type	Read start address	Bit position	Number of elements
0 1	0 1			0 0	
2	2	2	4	2	4

Service Response PDU

MRC	SRC	Response code	Read data (for number of elements)
0 1	0 1		
2	2	4	0, 8, or 16

(1) Variable Type and Read Start Address

For details on variable types and read start addresses, see *SECTION 3 Communications Data for CompoWay/F*.

(2) Bit Position

The E5CN-FR does not support bit access. Fixed to “00.”

(3) Number of Elements

Number of elements	Processing
0000	The read operation is not performed (read data is not appended to the service response PDU), and processing ends in “normal completion.”
0001 to 0002	The read operation is performed, and processing ends in “normal completion.”

(4) Response Code

Normal Completion

Response code	Name	Description
0000	Normal completion	No errors were found.

Error Occurred

Response code	Error name	Cause
1001	Command too long	The command is too long.
1002	Command too short	The command is too short.
1101	Area type error	The variable type is wrong.
1103	Start address out-of-range error	The read start address is out of range.
110B	Response too long	The number of elements is larger than "0002."
1100	Parameter error	Bit position is not "00."
2203	Operation error	EEPROM error

(5) Precautions

● Alarm Function

Even though alarms are not displayed on the Controller's display, they function normally in communications.

■ Write Variable Area

This service writes data to a variable area.

Service Request PDU

MRC	SRC	Variable type	Start write address	Bit position	Number of elements	Write Data (for number of elements)
0 1	0 2			0 0		
2	2	2	4	2	4	0, 8, or 16

Service Response PDU

MRC	SRC	Response code
0 1	0 2	
2	2	4

(1) Variable Type and Write Start Address

For details on variable types and write start addresses, see *SECTION 3 Communications Data for CompoWay/F*.

(2) Bit Position

The E5CN-FR does not support bit access. Fixed to "00."

(3) Number of Elements

Number of elements	Processing
0000	The write operation is not performed (do not append write data to the service request PDU) and processing ends in "normal completion."
0001 to 0002	The write operation is performed and processing ends in "normal completion."

(4) Response Code

Normal Completion

Response code	Name	Description
0000	Normal completion	No errors were found.

Error Occurred

Response code	Error name	Cause
1002	Command too short	The command is too short.
1101	Area type error	The variable type is wrong.
1103	Start address out-of-range error	Write start address is out of range.
1104	End address out-of-range error	The write end address (write start address + number of elements) exceeds the final address of the variable area.
1003	Number of elements/data mismatch	The number of data does not match the number of elements.
1100	Parameter error	<ul style="list-style-type: none"> • Bit position is not "00." • The write data is out of the setting range.
3003	Read-only error	Variable type "C0" was written to.
2203	Operation error	<ul style="list-style-type: none"> • The "communications writing" parameter is set to "OFF" (disabled). • Write operation was performed on the parameters from setup area 0 to setup area 1. • Write operation was performed on a protected parameter other than in the protect level. • EEPROM error

(5) Precautions

● Alarm Function

Even though alarms are not displayed on the Controller's display, they function normally in communications.

■ Read Controller Attributes

This service reads the model number and communications buffer size.

Service Request PDU

MRC	SRC
0 5	0 3
2	2

Service Response PDU

MRC	SRC	Response code	Model No.	Buffer size
0 5	0 3			0 0 2 8
2	2	4	10	4

(1) Model Number

The model number is expressed in 10-byte ASCII. When 10 bytes are not required, pad the remaining bytes with spaces.

Example: The following model number is used for the E5CN-FR2T (limit output, two alarm outputs, and multiple thermocouple/platinum resistance thermometer inputs).

e	5	c	n	-	F	R	2	T		
---	---	---	---	---	---	---	---	---	--	--

(2) Buffer Size

The communications buffer size is expressed in 2-byte hexadecimal, and read after being converted to 4-byte ASCII.

Buffer size: 40 bytes (= H'0028)

(3) Response Code

Normal Completion

Response code	Name	Description
0000	Normal completion	No errors were found.

Error Occurred

Response code	Name	Description
1001	Command too long	The command is too long.
2203	Operation error	EEPROM error

■ Read Controller Status

This service reads the operating status and error status.

Service Request PDU

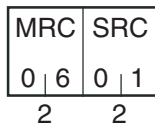

Service Response PDU

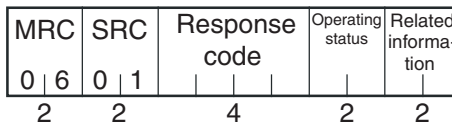

(1) Operating Status

Operating status	Description
00	Controller operation is normal (setup area 0).
01	Controller operation is stopped (setup area 1).

(2) Related Information

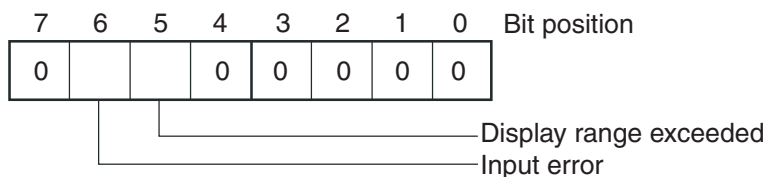

(3) Response Code

Normal Completion

Response code	Name	Description
0000	Normal completion	No errors were found.

Error Occurred

Response code	Name	Description
1001	Command too long	The command is too long.
2203	Operation error	EEPROM error

■ Echoback Test

This service performs an echoback test.

Service Request PDU

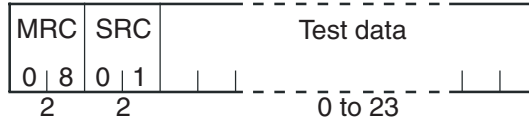

Service Response PDU

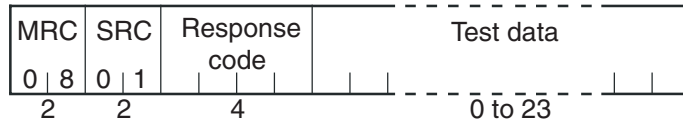

(1) Test Data

Set between 0 and 23 bytes of user-defined test data.

Set a value for the test data within the ranges shown below according to the communications data length.

Communications data length	Test Data
8 bits	ASCII data: H'20 to H'7E or H'A1 to H'FE
7 bits	ASCII data: H'20 to H'7E

Do not set the value H'40. No response will be returned.

(2) Response Code

Normal Completion

Response code	Name	Description
0000	Normal completion	No errors were found.

Error Occurred

Response code	Name	Description
1001	Command too long	The command is too long.
2203	Operation error	EEPROM error

■ Operation Command

This service performs operations such as communications writing, write mode, save RAM data, move to protect level, move to setup area 1, software reset, parameter initialization, and reset limit output.

Service Request PDU

MRC	SRC	Com- mand code	Related informa- tion
3 0	0 5		
2	2	2	2

Service Response PDU

MRC	SRC	Response code
3 0	0 5	
2	2	4

(1) Command Code and Related Information

Command code	Command content	Related Information
00	Communications writing	00: OFF (disabled) 01: ON (enabled)
04	Write mode	00: Backup 01: RAM
05	Save RAM data	00
06	Software reset (See note.)	00
07	Move to setup area 1	00
08	Move to protect level	00
0B	Parameter initialization	00
12	Reset limit output	00: Reset limit output 01: Hold/clear (See note 2.)

Note 1: No response will be returned when a software reset is carried out.

Note 2: Clear the limit over continuation time or limit over minimum/maximum value.

(2) Response Code

Normal Completion

Response code	Name	Description
0000	Normal completion	No errors were found.

Error Occurred

Response code	Error name	Cause
1001	Command too long	The command is too long.
1002	Command too short	The command is too short.
1100	Parameter error	Command code and related information are wrong.
2203	Operation error	<ul style="list-style-type: none"> The “communications writing” parameter is set to “OFF” (disabled). The command is received regardless of the “communications writing” parameter setting (ON/OFF). Processing could not be performed. For details, see (3) <i>Operation Commands and Precautions</i> below. EEPROM error

(3) Operation Commands and Precautions

● Communications Writing

Set the “communications writing” parameter to “ON: enabled” or “OFF: disabled” with the related information setting. The setting can be accepted in both setup area 0 and setup area 1.

● Write Mode

Set either the backup mode or RAM write mode with the related information setting. The setting can be accepted in both setup area 0 and setup area 1.

Write mode	Description
Backup mode	The data is written to EEPROM when the parameters in the operation/adjustment levels (excluding read-only parameters) are written by communications.
RAM write mode	The data is not written to EEPROM when the parameters in the operation/adjustment levels (excluding read-only parameters) are written by communications. Parameters can be changed by operating the keys on the front panel of the controller.

- When the mode is switched from RAM write mode to backup mode, the parameters in the operation/adjustment levels (excluding read-only parameters) are written to EEPROM.

- The RAM write mode is enabled only when the “communications writing” parameter is set to “ON” (enabled).

Consequently, when the “communications writing” parameter setting is changed to “OFF” (disabled), the parameters in the operation/adjustment levels (excluding read-only parameters) are written to EEPROM even if the mode is set to RAM write mode.

- Save RAM Data

This command writes the parameters in the operation/adjustment levels (excluding read-only parameters) to EEPROM. The setting can be accepted in both setup area 0 and setup area 1.

- Software Reset

Restarts processing from the point when power is turned ON. The setting can be accepted in both setup area 0 and setup area 1. No response will be returned for this operation command.

- Move to Setup Area 1

This command moves to “setup area 1” and can be accepted at both setup areas 0 and 1. If the “initial setup/communications protection” is set to “2,” an “operation error” will be generated, and the move to setup area 1 will be prohibited.

When this move is carried out from setup area 0, the display indicates the “input type” in the initial setting level. When this operation command is executed in setup area 1, the display will not change.

- Move to Protect Level

This command moves to the protect level and can be accepted only in setup area 0. When this command is issued in setup area 1, an “operation error” will be generated, and the move to the protect level will be prohibited.

- Parameter Initialization

The present settings are returned to the default values and written to EEPROM. This command can be accepted in setup area 1 only. When this command is issued in setup area 0, an “operation error” will be generated.

- Reset Limit

This is an operation command related to the Limit Controller functions. Related information is used to reset or hold/clear the limit output. This command can be accepted in setup area 0 only. If this command is issued in setup area 1 an “operation error” will occur.

2.4 Response Code List

Normal Completion

Response code	Name	Description	Error detection priority
0000	Normal completion	No errors were found.	None

Error Occurred

Response code	Name	Description	Error detection priority
0401	Unsupported command	The service function for the relevant command is not supported.	1
1001	Command too long	The command is too long.	2
1002	Command too short	The command is too short.	3
1101	Area type error	Wrong variable type	4
1103	Start address out-of-range error	The read/write start address is out of range.	5
1104	End address out-of-range error	The write end address (write start address + number of elements) exceeds the final address of the variable area.	6
1003	Number of elements/data mismatch	The amount of data does not match the number of elements.	7
110B	Response too long	The response exceeds the communications buffer size (when the number of elements is larger than 0002).	8
1100	Parameter error	<ul style="list-style-type: none"> • Bit position is not "00." • The write data is out of the setting range. • The command code or related information in the operation command is wrong. 	9
3003	Read-only error	Variable type "C0" was written to.	10
2203	Operation error	<ul style="list-style-type: none"> • The "communications writing" parameter is set to "OFF" (disabled). • Write operation was performed on the parameters from setup area 0 to setup area 1. • Write operation was performed on a protected parameter other than in the protect level. • Processing is not possible by operation command. • EEPROM error 	11

SECTION 3

Communications Data for CompoWay/F

This section shows the communications data format used in CompoWay/F communications. Refer to this section when reading or setting data via CompoWay/F communications.

3.1	Variable Area (Setting Range) List	3-2
3.2	Status.....	3-7

3.1 Variable Area (Setting Range) List

The following table lists the variable areas. Items expressed in hexadecimal in the “Set (monitor) value” column are the setting range for CompoWay/F communications. The values in parentheses are the actual setting range. When there is a section reference for a setting item, refer to that reference for details.

Variable type	Address	Parameter name	Setting (monitor) value	Level
C0	0000	PV	Use the specified range for each sensor.	Operation
C0	0001	Status (See note 1.)	See 3.2 <i>Status</i> for details.	
C0	000A	Limit over continuation time (See note 2.)	H'00000000 to H'000026E7 (0 to 9959)	
C0	000B	Limit over minimum/maximum value (See note 3.)	Use the specified range for each sensor.	
C1	0000	Operation/adjustment protect	H'00000000 (0): No restrictions in operation and adjustment levels H'00000001 (1): Move to adjustment level is prohibited. H'00000002 (2): Display of only “Limit SP” or “PV/Limit SP” parameters is allowed.	Protect
C1	0001	Initial setting/communications protect	H'00000000 (0): Move to initial setting/communications setting level is allowed. (Move to advanced function setting level is displayed.) H'00000001 (1): Move to initial setting/communications setting level is allowed. (Move to advanced function setting level is not displayed.) H'00000002 (2): Move to initial setting/communications setting level is prohibited.	
C1	0002	Setup change protection	H'00000000 (0): OFF (Changing of setup on Controller display is allowed.) H'00000001 (1): ON (Changing of setup on Controller display is prohibited.)	

Variable type	Address	Parameter name	Setting (monitor) value	Level
C1	0003	Limit SP	Use the specified range for each sensor.	Adjustment
C1	0004	Alarm value 1	H'FFFFFF831 to H'0000270F (–1999 to 9999)	
C1	0005	Upper-limit alarm 1	H'FFFFFF831 to H'0000270F (–1999 to 9999)	
C1	0006	Lower-limit alarm 1	H'FFFFFF831 to H'0000270F (–1999 to 9999)	
C1	0007	Alarm value 2	H'FFFFFF831 to H'0000270F (–1999 to 9999)	
C1	0008	Upper-limit alarm 2	H'FFFFFF831 to H'0000270F (–1999 to 9999)	
C1	0009	Lower-limit alarm 2	H'FFFFFF831 to H'0000270F (–1999 to 9999)	
C1	000A	Alarm value 3	H'FFFFFF831 to H'0000270F (–1999 to 9999)	
C1	000B	Upper-limit alarm value 3	H'FFFFFF831 to H'0000270F (–1999 to 9999)	
C1	000C	Lower-limit alarm value 3	H'FFFFFF831 to H'0000270F (–1999 to 9999)	
C1	0012	Temperature input shift value	H'FFFFFF831 to H'0000270F (–199.9 to 999.9)	
C1	0013	Upper-limit temperature input shift value	H'FFFFFF831 to H'0000270F (–199.9 to 999.9)	
C1	0014	Lower-limit temperature input shift value	H'FFFFFF831 to H'0000270F (–199.9 to 999.9)	
C1	001B	Hysteresis	H'00000001 to H'0000270F (0.1 to 999.9)	
C1	0028	Move to protect level	H'FFFFFF831 to H'0000270F (–1999 to 9999)	Protect
C1	0029	Password to move to protect level	H'FFFFFF831 to H'0000270F (–1999 to 9999) (Can only be set. The monitor value is always H'00000000.)	

Variable type	Address	Parameter name	Setting (monitor) value	Level
C3	0000	Input type	H'00000000 (0): Pt (–200 to 850°C/–300 to 1500°F) H'00000001 (1): Pt (–199.9 to 500.0°C/–199.9 to 900.0°F) H'00000002 (2): Pt (0.0 to 100.0°C/0.0 to 210.0°F) H'00000003 (3): JPt (–199.9 to 500.0°C/–199.9 to 900.0°F) H'00000004 (4): JPt (0.0 to 100.0°C/0.0 to 210.0°F) H'00000005 (5): K (–200 to 1300°C/–300 to 2300°F) H'00000006 (6): K (–20.0 to 500.0°C/0.0 to 900.0°F) H'00000007 (7): J (–100 to 850°C/–100 to 1500°F) H'00000008 (8): J (–20.0 to 400.0°C/0.0 to 750.0°F) H'00000009 (9): T (–200 to 400°C/–300 to 700°F) H'0000000A (10): T (–199.9 to 400.0°C/–199.9 to 700.0°F) H'0000000B (11): E (0 to 600°C/0 to 1100°F) H'0000000C (12): L (–100 to 850°C/–100 to 1500°F) H'0000000D (13): U (–200 to 400°C/–300 to 700°F) H'0000000E (14): U (–199.9 to 400.0°C/–199.9 to 700.0°F) H'0000000F (15): N (–200 to 1300°C/–300 to 2300°F) H'00000010 (16): R (0 to 1700°C/0 to 3000°F) H'00000011 (17): S (0 to 1700°C/0 to 3000°F) H'00000012 (18): B (100 to 1800°C/300 to 3200°F) H'00000013 (19): Infrared temperature sensor (10 to 70°C) H'00000014 (20): Infrared temperature sensor (60 to 120°C) H'00000015 (21): Infrared temperature sensor (115 to 165°C) H'00000016 (22): Infrared temperature sensor (140 to 260°C)	Initial setting
C3	0004	Temperature unit	H'00000000 (0): °C H'00000001 (1): °F	
C3	000D	Alarm 1 type	H'00000000 (0): Alarm function OFF H'00000001 (1): Upper and lower-limit alarm H'00000002 (2): Upper-limit alarm H'00000003 (3): Lower-limit alarm H'00000004 (4): Upper and lower-limit range alarm H'00000005 (5): Upper and lower-limit alarm with standby sequence H'00000006 (6): Upper-limit alarm with standby sequence H'00000007 (7): Lower-limit alarm with standby sequence H'00000008 (8): Absolute-value upper-limit alarm H'00000009 (9): Absolute-value lower-limit alarm H'0000000A (10): Absolute-value upper-limit alarm with standby sequence H'0000000B (11): Absolute-value lower-limit alarm with standby sequence H'0000000C (12): Annunciator	Initial setting
C3	000E	Alarm 2 type	Same settings as the alarm 1 type	
C3	000F	Alarm 3 type	Same settings as the alarm 1 type	

Variable type	Address	Parameter name	Setting (monitor) value	Level
C3	0010	Communications unit number (See note 4.)	H'00000000 to H'00000063 (0 to 99)	Communications setting
C3	0011	Communications baud rate (See note 4.)	H'00000000 (0): 1.2 H'00000001 (1): 2.4 H'00000002 (2): 4.8 H'00000003 (3): 9.6 H'00000004 (4): 19.2 H'00000005 (5): 38.4	
C3	0012	Communications data length (See note 4.)	H'00000007 (7): 7 H'00000008 (8): 8	
C3	0013	Communications stop bits (See note 4.)	H'00000001 (1): 1 H'00000002 (2): 2	
C3	0014	Communications parity (See note 4.)	H'00000000 (0): None H'00000001 (1): Even H'00000002 (2): Odd	
C3	0016	Event input assignment 1	H'00000000 (0): None H'00000001 (1): Reset input H'00000002 (2): Hold clear input	Advanced function setting
C3	0017	Event input assignment 2	Same setting as event input assignment 1	
C3	001D	Standby sequence reset	H'00000000 (0): Condition A H'00000001 (1): Condition B	
C3	001E	Alarm 1 open in alarm	H'00000000 (0): Close in alarm H'00000001 (1): Open in alarm	
C3	001F	Alarm 1 hysteresis	H'00000001 to H'0000270F (0.1 to 999.9)	
C3	0020	Alarm 2 open in alarm	H'00000000 (0): Close in alarm H'00000001 (1): Open in alarm	
C3	0021	Alarm 2 hysteresis	H'00000001 to H'0000270F (0.1 to 999.9)	
C3	0022	Alarm 3 open in alarm	H'00000000 (0): Close in alarm H'00000001 (1): Open in alarm	
C3	0023	Alarm 3 hysteresis	H'00000001 to H'0000270F (0.1 to 999.9)	
C3	002B	Input digital filter	H'00000000 to H'0000270F (0.0 to 999.9)	
C3	002C	Additional PV display	H'00000000 (0): OFF H'00000001 (1): ON	
C3	002E	Automatic display return time	H'00000000 (0): OFF H'00000001 to H'00000063 (1 to 99)	
C3	002F	Alarm 1 latch	H'00000000 (0): OFF H'00000001 (1): ON	
C3	0030	Alarm 2 latch	H'00000000 (0): OFF H'00000001 (1): ON	
C3	0031	Alarm 3 latch	H'00000000 (0): OFF H'00000001 (1): ON	

Variable type	Address	Parameter name	Setting (monitor) value	Level
C3	0033	Input error output	H'00000000 (0): OFF H'00000001 (1): ON	Advanced function setting
C3	0036	PV change color	H'00000001 (1): RED H'00000002 (2): GRN H'00000003 (3): A.R-G H'00000004 (4): A.G-R H'00000005 (5): L.R-G H'00000006 (6): L.G-R	
C3	004C	Protocol Setting (See note 4.)	H'00000000 (0): CompoWay/F H'00000001 (1): Modbus	Communications setting
C3	004D	Send data wait time (See note 4.)	H'00000000 to H'00000063 (0 to 99)	
C3	0060	Selecting upper/lower limit	H'00000000 (0): Upper limit H'00000001 (1): Lower limit	Initial setting
C3	0061	Restart mode	H'00000000 (0): Normal monitor status H'00000001 (1): Limit status (limit output OFF)	Advanced function setting
C3	0062	Time selection	H'00000000 (0): Limit output H'00000001 (1): Limit status	

* The alarm function can also be used in Controllers without alarm output terminals. In this case, confirm alarm occurrences via the status data.

Note 1. Not displayed on the Controller display.

Note 2. The “limit over continuation time” is a numerical value that is given according to the display format (hr.mn) in the No. 2 display (0.00 to 99.59 corresponds to H'00000000 (0) to H'000026E7 (9959)). When a limit over has not occurred (i.e., when the No. 2 display is “----”), the value will be 0.

Note 3. The “selecting upper/lower limit” parameter is used to determine the value for the “limit over maximum/minimum value” parameter. When a limit over has not occurred (i.e., when the No. 2 display is “----”), the value is refreshed according to the PV. If an input error occurs (i.e., when *S.ERR* is displayed alternately on the No. 2 display), the “limit over maximum/minimum value” will be set to the upper limit or lower limit of the input range for each sensor.

Note 4. After communications parameters have been changed, they are enabled by resetting the Controller.

3.2 Status

The figure below shows the structure of the status data.

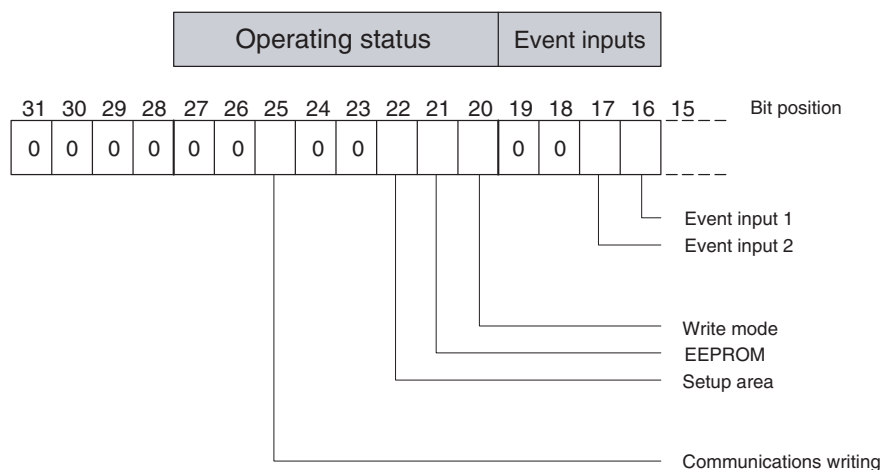
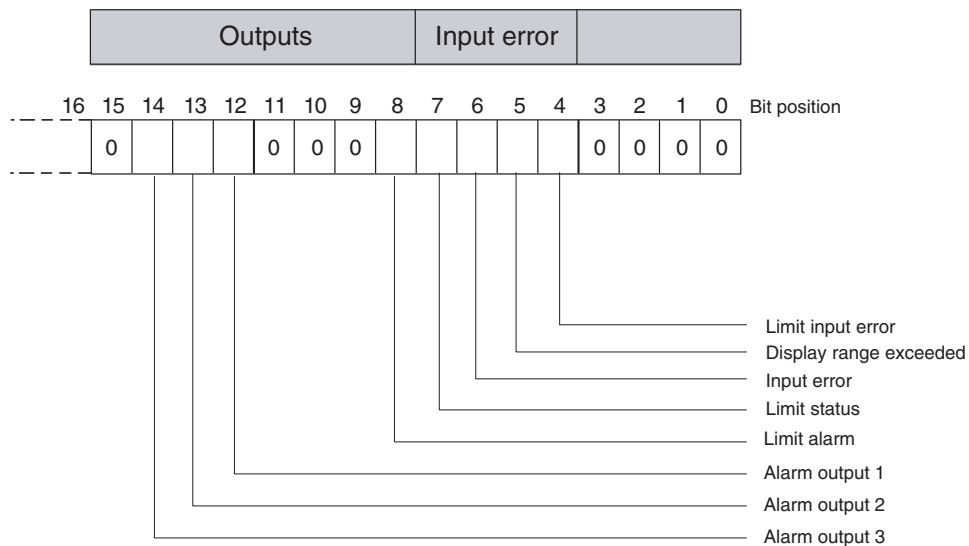

Bit position	Status	Bit Description	
		0	1
0	Spare	OFF	---
1	Spare	OFF	---
2	Spare	OFF	---
3	Spare	OFF	---
4	Limit input error	Not generated	Generated
5	Display range exceeded	Not generated	Generated
6	Input error	Not generated	Generated
7	Limit status	OFF	ON
8	Limit alarm	OFF	ON
9	Spare	OFF	---
10	Spare	OFF	---
11	Spare	OFF	---
12	Alarm 1 output	OFF	ON
13	Alarm 2 output	OFF	ON
14	Alarm 3 output	OFF	ON
15	Spare	OFF	---
16	Event input 1	OFF	ON
17	Event input 2	OFF	ON
18	Spare	OFF	---
19	Spare	OFF	---
20	Write mode	Backup mode	RAM write mode
21	EEPROM	RAM = EEPROM	RAM ≠ EEPROM
22	Setup area	Setup area 0	Setup area 1
23	Spare	OFF	---
24	Spare	OFF	---
25	Communications writing	OFF (disabled)	ON (enabled)
26	Spare	OFF	---
27	Spare	OFF	---
28	Spare	OFF	---
29	Spare	OFF	---
30	Spare	OFF	---
31	Spare	OFF	---

Note 1. "Spare" bits are always OFF.

Note 2. The limit input error is the status indicating that an input error has occurred, and shows whether $S.ERR$, $-H\bar{L}$ or $-L\bar{O}$ is displayed for the "limit over maximum/minimum value" parameter on the No. 2 display.

Note 3. When the limit alarm is ON, the limit output relay is OFF (limit output status).

Note 4. When read in setup area 1, the status of the bits will be as follows:

- Display range exceeded: Last value held
- Input error: Last value held
- Limit status: Last value held
- Limit input error: Last value held
- Limit alarm: Set (The limit output relay in setup area 1 will turn OFF, so the status is set according to the limit output relay.)
- Alarm outputs: Cleared

SECTION 4

Modbus Communications Procedure

Read this section when using Modbus communications to perform operations from a host computer, such as reading/writing variable area data or sending operation commands.

4.1	Data Format.....	4-2
	Command Frame.....	4-2
	CRC-16 Calculation Example.....	4-3
	Response Frame	4-4
	Normal Response Frame	4-4
	Error Response Frame.....	4-4
	Error Codes	4-5
	No Response.....	4-5
4.2	Function List	4-6
4.3	Variable Area	4-7
	Addresses	4-7
	Number of Elements.....	4-7
	Set Values	4-8
4.4	Detailed Description of the Services.....	4-9
	Read Variable Area	4-9
	Write Variable Area	4-11
	Operation Commands	4-14
	Echoback Test.....	4-17

4.1 Data Format

The data format complies with the Modbus (RTU) communications protocol, so commands from the host computer and responses from the E5CN-FR are contained in data blocks called frames.

The structure of the command and response frames is described below.

In the following explanations, hexadecimal values are expressed by adding the prefix H' before the number, e.g., H'02. Numbers and alphabetic characters without the H' prefix are ASCII characters.

■ Command Frame

When using RTU mode, start with a silent interval of at least 3.5 character times and end with a silent interval of at least 3.5 character times.

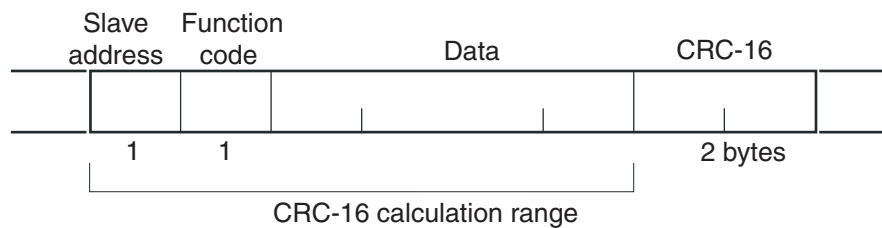

	Silent interval of 3.5 character times min.
Slave address	Specify the unit number. The unit number can be set between H'00 to H'63 hexadecimal (0 to 99 decimal). Specify H'00 for a broadcast transmission. No responses will be returned for broadcast transmissions.
Function code	The function code is a 1-byte hexadecimal code that indicates the type of command sent from the host device.
Data	This is the text data associated with the specified function code. Specify the required data, such as the variable address or setting data. (Set in hexadecimal.)
CRC-16	Cyclical Redundancy Check This check code is calculated with the data from the slave address to the end of the data. The check code is 2-byte hexadecimal.
	Silent interval of 3.5 character times min.

● CRC-16 Calculation Example

Messages are processed one byte at a time in the work memory (a 16-bit register known as the CRC register).

- (1) The CRC register is initialized to H'FFFF.
- (2) An XOR operation is performed on the content of the CRC register and the first byte of the message, and the result is returned to the CRC register.
- (3) The MSB is packed with zeroes and the CRC register is shifted 1 bit to the right.
- (4) If the bit shifted from the LSB is 0, step 3 is repeated (next bit-shift processing).
If the bit shifted from the LSB is 1, an XOR is performed on the content of the CRC register and H'A001, and the result is returned to the CRC register.
- (5) Steps 3 and 4 are repeated until 8 bits are shifted.
- (6) CRC processing continues to the end of the message, as XOR operations are performed on the content of the CRC register and the next byte of the message, step 3 is repeated, and the result is returned to the CRC register.
- (7) The result of the CRC calculation (value in the CRC register) is appended to the last byte of the message.

Example of Appending the Calculation Result

When the calculated CRC value is H'1234, the CRC value is appended to the command frame as follows.

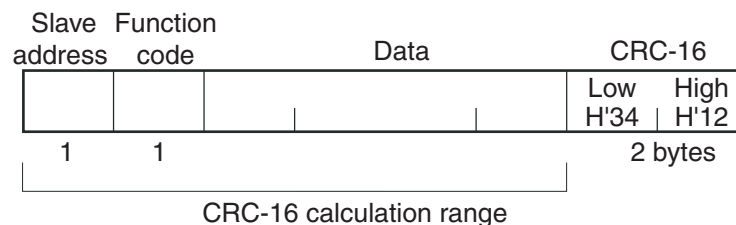

■ Response Frame

● Normal Response Frame

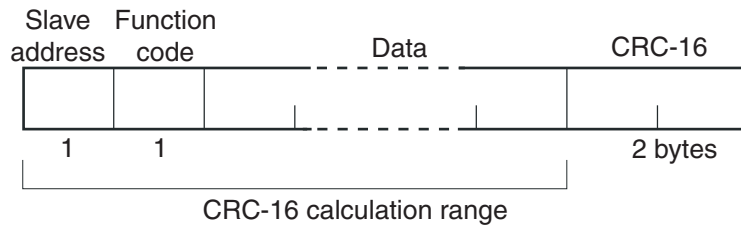

● Error Response Frame

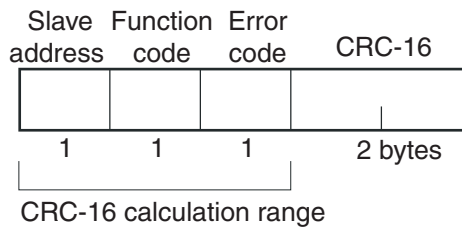

Slave address	The number specified in the command frame is entered as-is. This is the unit number of the Unit returning the response.
Function code	This is the received function code. When the function ended normally, the function code is left as-is. When an error occurred, the hexadecimal value of H'80 is added to the function code to indicate that the response is an error response. Example: Received function code = H'03 Function code in response frame when an error occurred = H'83
Error code	This code indicates the kind of error that occurred.
CRC-16	Cyclical Redundancy Check This check code is calculated with the data from the slave address to the end of the data. The check code is 2-byte hexadecimal.

■ Error Codes

End code	Name	Description	Error detection priority
H'01	Function code error	An unsupported function code was received.	1
H'02	Variable address error	The specified variable area address is out-of-range.	2
H'03	Variable data error	The amount of data does not match the number of elements. The byte count is not 2 times the number of elements. The response length exceeds the size of the communications buffer. The command code or related information in the operation command is wrong or the write data is not in the setting range.	3
H'04	Operation error	The write data contents are not allowed in the present operation mode. <ul style="list-style-type: none"> ◆ The “communications writing” parameter is set to “OFF” (disabled). ◆ Write operation was performed to write the parameters from setup area 0 to setup area 1. ◆ Write operation was performed on a protected parameter other than in the protect level. ◆ The command cannot be processed. 	4

● No Response

In the following cases, the received command will not be processed and a response will not be returned.

Consequently, a timeout error will occur at the host device.

- The slave address in the received command does not match the communications unit number.
- A parity error, framing error, or overrun error occurred due to a problem such as a transfer error.
- A CRC-16 code error occurred in the received command frame.
- There was a time interval of more than 3.5 character times between data packets that make up the command frame.

Furthermore, the specified function’s processing will be performed but no response will be returned for broadcast functions (slave address = H'00).

4.2 Function List

The following table lists the function codes.

Function Code List

Function code	Name	Process
03 (H'03)	Read variable (multiple)	This function reads from variable areas. It is possible to read two or more consecutive variables.
16 (H'10)	Write variable (multiple)	This function writes to variable areas. It is possible to write two or more consecutive variables. It is also possible to broadcast this function (broadcast transmission).
06 (H'06)	Write variable (operation command)	This function writes an operation command. It is also possible to broadcast this function (broadcast transmission).
08 (H'08)	Echoback Test	This function performs an echoback test.

4.3 Variable Area

The variable area is the region of memory used to exchange data with the E5CN-FR through communications.

Operations such as reading the process value and reading/writing parameters are performed on the variable area.

On the other hand, operation commands do not use the variable area.

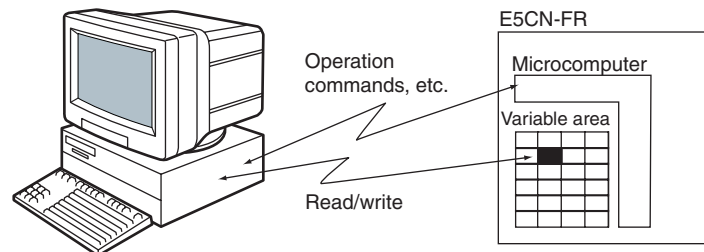

When accessing the variable area, the position of a variable in the variable area is specified with a word identifier, area number, and address in the area.

● Addresses

An address is appended to each of the variable types. Express addresses in 2-byte hexadecimal and append them for the specified access size. Each address is composed of a word identifier, area number, and address in the area.

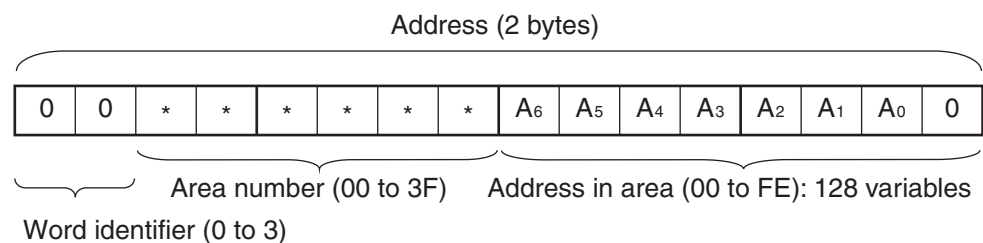

◆ Modbus Addresses Corresponding to CompoWay/F Setup Areas 0 and 1

Setup area 0 and setup area 1 do not correspond directly to Modbus addresses.

● Number of Elements

The number of elements is expressed in 2-byte hexadecimal. The setting range for the number of elements varies according to the command.

For example, when the number of elements is “0010,” this specifies eight items of data (H'10) from the address.

In Modbus protocol, one element occupies 2 bytes of data, but the setting data occupies 4 bytes of data.

● Set Values

The values read from the variable area or written to the variable area are expressed in hexadecimal, ignoring the decimal point position. (Negative values are expressed in 2's complement format.)

Example: D'105.0 → H'0000041A

The variables are 8-digit hexadecimal values. Negative values are expressed in 2's complement format. The values are hexadecimal values with no decimal point indication.

For example, when the E5CN-FR's process value is 105.0, the read value is H'0000041A (105.0 → 1050 → H'0000041A).

4.4 Detailed Description of the Services

■ Read Variable Area

To read from the variable area, set the required data in the command frame, as shown in the following diagram.

Command Frame

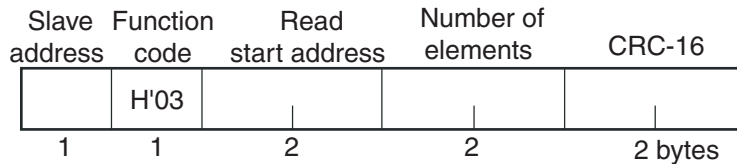

Name	Description
Slave address	Specify the E5CN-FR's unit number. The unit number can be set between H'01 and H'63 hexadecimal (1 to 99 decimal).
Function code	The Read Variable Area function's function code is H'03.
Read start address	Specify the address containing the data to be read. See <i>SECTION 5 Communications Data for Modbus</i> for details on addresses.
Number of elements	Specify 2 times the number of setting data items as the number of elements to be read. The setting range for the number of elements is H'0002 to H'0010 (2 to 16). Example: When reading 2 items of setting data, set the number of elements to H'0004.
CRC-16	This check code is calculated with the data from the slave address to the end of the data. For details on the CRC-16 calculation, see <i>CRC-16 Calculation Example</i> in <i>4.1 Data Format</i> on page 4-3.

Response Frame

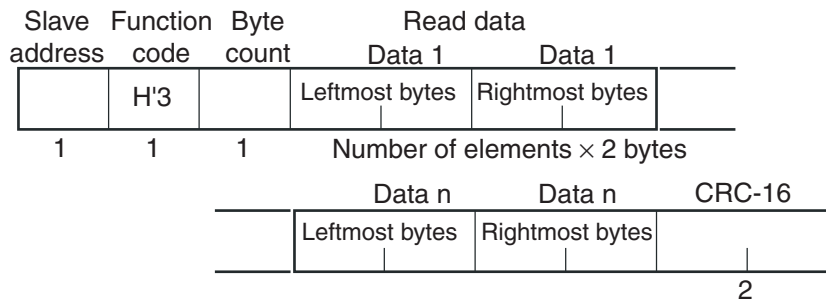

Name	Description
Slave address	The value from the command frame is entered as-is.
Function code	This is the received function code. When the function ended normally, the function code is left as-is. When an error occurred, the hexadecimal value of H'80 is added to the function code to indicate that the response is an error response. Example: Received function code = H'03 Function code in response frame when an error occurred = H'83
Byte count	Contains the number of bytes of read data.
Number of elements	Contains the number of setting data items that were read.
CRC-16	This check code is calculated with the data from the slave address to the end of the data. For details on the CRC-16 calculation, see <i>CRC-16 Calculation Example</i> in 4.1 Data Format on page 4-3.

Response Code

Function code	Error code	Error name	Cause
H'83	H'02	Variable address error	The read start variable address is incorrect. • The variable area number is incorrect.
	H'03	Variable data error	The number of elements exceeds the allowed range.
H'03	---	Normal completion	No errors were found.

◆ Reading Undisplayed Parameters

It is possible to read the parameters that are not displayed due to display settings as well as the parameters that are never displayed in the Controller.

Example Command and Response

The following example shows the command/response when reading the process value. (In this case, the slave address is H'01.)

Process Value

- Address: H'0000; Read data: H'000003E8 (100.0 °C)

Command: 01 03 00 00 00 02 C4 0B(CRC-16)

Response: 01 03 04 00 00 03 E8 FA 8D(CRC-16)

■ Write Variable Area

To write data to the variable area, set the required data in the command frame, as shown in the following diagram.

Command Frame

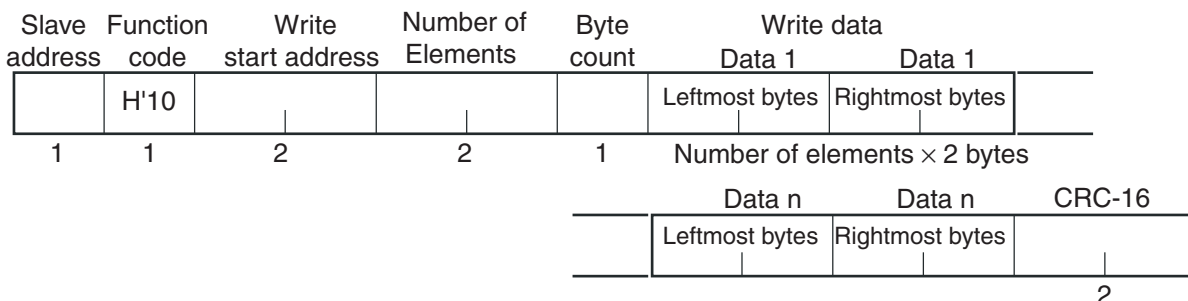

Name	Description
Slave address	Specify the E5CN-FR's unit number. The unit number can be set between H'01 and H'63 hexadecimal (1 to 99 decimal).
Function code	The Write Variable Area function's function code is H'10.
Write start address	Specify the starting address where the setting data will be written. See <i>SECTION 5 Communications Data for Modbus</i> for details on addresses.
Number of elements	Specify 2 times the number of setting data items as the number of elements to be written. The setting range for the number of elements is H'0002 to H'000E (2 to 14). Example: When writing 2 items of setting data, set the number of elements to H'0004.
Byte count	Specify the number of bytes of write data.
CRC-16	This check code is calculated with the data from the slave address to the end of the data. For details on the CRC-16 calculation, see <i>CRC-16 Calculation Example</i> in 4.1 Data Format on page 4-3.

Response Frame

Slave address	Function code	Write start address	Number of Elements	CRC-16
1	H'10	2	2	2 bytes

Name	Description
Slave address	The value from the command frame is entered as-is.
Function code	This is the received function code. When the function ended normally, the function code is left as-is. When an error occurred, the hexadecimal value of H'80 is added to the function code to indicate that the response is an error response. Example: Received function code = H'10 Function code in response frame when an error occurred = H'90
Write start address	This is the received write start address.
Number of elements	This is the received number of elements.
CRC-16	This check code is calculated with the data from the slave address to the end of the data. For details on the CRC-16 calculation, see <i>CRC-16 Calculation Example</i> in 4.1 Data Format on page 4-3.

Response Code

Function code	Error code	Error name	Cause
H'90	H'02	Variable address error	The write start variable address is incorrect. • The variable area number is incorrect.
	H'03	Variable data error	<ul style="list-style-type: none"> ◆ The amount of data does not match the number of elements. ◆ The byte count is not 2 times the number of elements. ◆ The write data is out of the setting range.
	H'04	Operation error	<p>The Controller cannot write the data in its present operating status. The write data contents are not allowed in the present operation mode.</p> <ul style="list-style-type: none"> ◆ The “communications writing” parameter is set to “OFF” (disabled). ◆ Write operation was performed on the parameters from setup area 0 to setup area 1. ◆ Write operation was performed on a protected parameter other than in the protect level.
H'10	---	Normal completion	No errors were found.

◆ Writing Undisplayed Parameters

It is possible to write the parameters that are not displayed due to display settings as well as the parameters that are never displayed in the Controller.

Example Command and Response

The following example shows the command/response when writing the “upper-limit alarm 1” and “lower-limit alarm 1” parameters.

(In this case, the slave address is H'01.)

Upper-limit alarm 1

- Address: H'010A Write data: H'000003E8 (1,000)

Lower-limit alarm 1

- Address: H'010C Write data: H'FFFFFFC18 (-1,000)

Command: 01 10 01 0A 00 04 08 00 00 03 E8 FF FF FC 18 8D E9(CRC-16)
 Response: 01 10 01 0A 00 04 E0 34(CRC-16)

■ Operation Commands

This function performs commands such as communications writing, write mode, save RAM data, software reset, move to setup area 1, move to protect level, parameter initialization, and reset limit.

Command Frame

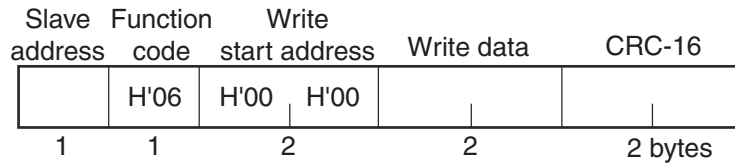

Response Frame

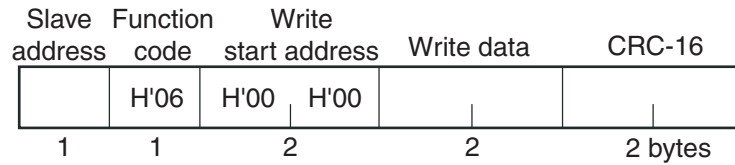

(1) Command Code and Related Information

Command code	Command content	Related information
00	Communications writing	00: OFF (disabled) 01: ON (enabled)
04	Write mode	00: Backup 01: RAM
05	Save RAM data	00
06	Software reset*	00
07	Move to setup area 1	00
08	Move to protect level	00
0B	Parameter initialization	00
12	Reset limit	00: Reset limit output 01: Hold/clear

* No response will be returned when a software reset is carried out.

(2) Response Code

Normal Completion

Function code	Error code	Name	Cause
H'06	---	Normal completion	No errors were found.

Error Occurred

Function code	Error code	Name	Cause
H'86	H'02	Variable address error	The write variable address was not "0000."
	H'03	Variable data error	The write data is incorrect. <ul style="list-style-type: none"> Command code or related information are incorrect.
	H'04	Operation error	The Controller cannot write the data in its present operating status. <ul style="list-style-type: none"> The "communications writing" parameter is set to "OFF" (disabled). The command is received regardless of the "communications writing" parameter setting (ON/OFF). Processing could not be performed. For details, see (4) <i>Operation Commands and Precautions</i> below.

(3) Example Command and Response

The following example shows the command/response when communications writing is enabled. (In this case, the slave address is H'01.)

Communications writing enabled (command code: 00; related information: 01)

•Address: H'0000 (fixed)

Write data: H'0001 (communications writing enabled)

Command: 01 06 00 00 00 01 48 0A(CRC-16)

Response: 01 06 00 00 00 01 48 0A(CRC-16)

(4) Operation Commands and Precautions

● Communications Writing

Set the “communications writing” parameter to “ON” (enabled) or “OFF” (disabled) with the related information setting.

The setting can be accepted in both setup area 0 and setup area 1.

● Write Mode

Set either “backup mode” or “RAM write mode” with the related information setting. The setting can be accepted in both setup area 0 and setup area 1.

Write mode	Description
Backup mode	The data is written to EEPROM when the parameters in the operation/adjustment levels (excluding read-only parameters) are written by communications.
RAM write mode	The data is not written to EEPROM when the parameters in the operation/adjustment levels (excluding read-only parameters) are written by communications. Parameters can be changed by operating the keys on the front panel of the controller.

- When the mode is switched from RAM write mode to backup mode, the parameters in the operation/adjustment levels (excluding read-only parameters) are written to EEPROM.
- The RAM write mode is enabled only when the “communications writing” parameter is set to “ON” (enabled).
Consequently, when the “communications writing” parameter setting is changed to “OFF” (disabled), the parameters in the operation/adjustment levels (excluding read-only parameters) are written to EEPROM even if the RAM write mode is set to “disabled.”

● RAM Data

This command writes the parameters in the operation/adjustment levels (excluding read-only parameters) to EEPROM. The setting can be accepted in both setup area 0 and setup area 1.

● Software Reset

Restarts processing from the point when power is turned ON. The setting can be accepted in both setup area 0 and setup area 1. No response will be returned for this operation.

- Move to Setup Area 1

This command moves to “setup area 1” and can be accepted at both setup areas 0 and 1. If the “initial setup/communications protection” is set to “2,” an “operation error” will be generated, and the move to setup area 1 will be prohibited.

When this move is carried out from setup area 0, the display indicates the “input type” in the initial setting level. When this operation command is executed in setup area 1, the display will not change.

- Move Protect Level

This command moves to the protect level and can be accepted only in setup area 0. When this command is issued in setup area 1, an “operation error” will be generated, and the move to the protect level will be prohibited.

- Parameter Initialization

The present settings are returned to the default values and written to EEPROM. This command can be accepted in setup area 1 only. When this command is issued in setup area 0, an “operation error” will be generated.

- Reset Limit

This is an operation command related to the Limit Controller functions. Related information is used to reset or hold/clear the limit output. This command can be accepted in setup area 0 only. If this command is issued in setup area 1 an “operation error” will occur.

■ Echoback Test

Command Frame

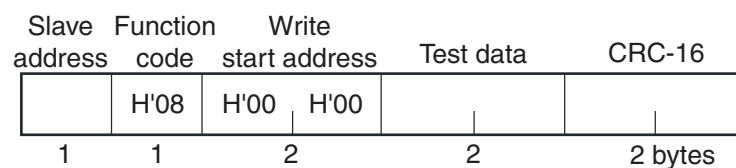

Response Frame

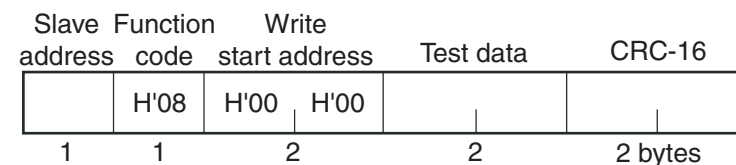

* When the command is executed normally, the response returns the same data sent in the command.

(1) Test Data

Enter any 2-byte hexadecimal data.

(2) Response Code

Function code	Error code	Name	Description
H'88	H'03	Variable data error	The data following the function code was not the fixed data (H'00, H'00).
H'08	---	Normal completion	No errors were found.

(3) Example Command and Response

The following example shows the command/response for an Echoback Test command.

(In this case, the test data is H'1234.)

(In this case, the slave address is H'01.)

Command: 01 08 00 00 12 34 ED 7C(CRC-16)
Response: 01 08 00 00 12 34 ED 7C(CRC-16)

SECTION 5

Communications Data for Modbus

This section shows the communications data format used in Modbus communications. Refer to this section when reading or setting data via Modbus communications.

5.1	Variable Area (Setting Range) List	5-2
5.2	Status.....	5-7

5.1 Variable Area (Setting Range) List

The following table lists the variable areas. Items expressed in hexadecimal in the “Set (monitor) value” column are the setting range in the Modbus specifications. Values in parentheses “()” are the actual setting range.

When there is a section reference for a setting item, refer to that reference for details.

Address	Parameter name	Setting (monitor) value	Level
0000	PV	Use the specified range for each sensor.	Operation
0002	Status (See note 1.)	See the 5.2 Status for details.	
0106	Limit SP	Use the specified range for each sensor.	Adjustment
0108	Alarm value 1	H'FFFFFF831 to H'0000270F (–1999 to 9999)	
010A	Upper-limit alarm 1	H'FFFFFF831 to H'0000270F (–1999 to 9999)	
010C	Lower-limit alarm 1	H'FFFFFF831 to H'0000270F (–1999 to 9999)	
010E	Alarm value 2	H'FFFFFF831 to H'0000270F (–1999 to 9999)	
0110	Upper-limit alarm 2	H'FFFFFF831 to H'0000270F (–1999 to 9999)	
0112	Lower-limit alarm 2	H'FFFFFF831 to H'0000270F (–1999 to 9999)	
0404	PV	Use the specified range for each sensor.	Operation
040C	Status (See note 1.)	See the 5.2 Status for details.	
0500	Operation/adjustment protect	H'00000000 (0): No restrictions in operation and adjustment levels H'00000001 (1): Move to adjustment level is prohibited. H'00000002 (2): Display of only “Limit SP” and “PV/Limit SP” parameters is allowed.	Protect
0502	Initial setting/communications protect	H'00000000 (0): Move to initial setting/communications setting level is allowed. (Move to advanced function setting level is displayed.) H'00000001 (1): Move to initial setting/communications setting level is allowed. (Move to advanced function setting level is not displayed.) H'00000002 (2): Move to initial setting/communications setting level is prohibited.	
0504	Setup change protection	H'00000000 (0): OFF (Changing of setup on controller display is allowed.) H'00000001 (1): ON (Changing of setup on controller display is prohibited.)	
0508	Move to protect level	H'FFFFFF831 to H'0000270F (–1999 to 9999)	
050A	Password to move to protect level	H'FFFFFF831 to H'0000270F (–1999 to 9999) (Can only be set. The monitor value is always H'00000000.)	

Address	Parameter name	Setting (monitor) value	Level
0602	Limit SP	Use the specified range for each sensor.	Adjustment
070C	Hysteresis	H'00000001 to H'0000270F (0.1 to 999.9)	
072C	Lower-limit temperature input shift value	H'FFFFFF831 to H'0000270F (-199.9 to 999.9)	
0730	Upper-limit temperature input shift value	H'FFFFFF831 to H'0000270F (-199.9 to 999.9)	
0746	Temperature input shift value	H'FFFFFF831 to H'0000270F (-199.9 to 999.9)	
0756	Limit over continuation time (See note 2.)	H'00000000 to H'000026E7 (0 to 9959)	Operation
0758	Limit over minimum/maximum value (See note 3.)	Use the specified range for each sensor.	
0800	Input digital filter	H'00000000 to H'0000270F (0.0 to 999.9)	Advanced function setting
0904	Alarm value 1	H'FFFFFF831 to H'0000270F (-1999 to 9999)	Adjustment
0906	Upper-limit alarm 1	H'FFFFFF831 to H'0000270F (-1999 to 9999)	
0908	Lower-limit alarm 1	H'FFFFFF831 to H'0000270F (-1999 to 9999)	
090A	Alarm value 2	H'FFFFFF831 to H'0000270F (-1999 to 9999)	
090C	Upper-limit alarm 2	H'FFFFFF831 to H'0000270F (-1999 to 9999)	
090E	Lower-limit alarm 2	H'FFFFFF831 to H'0000270F (-1999 to 9999)	
0910	Alarm value 3	H'FFFFFF831 to H'0000270F (-1999 to 9999)	
0912	Upper-limit alarm value 3	H'FFFFFF831 to H'0000270F (-1999 to 9999)	
0914	Lower-limit alarm value 3	H'FFFFFF831 to H'0000270F (-1999 to 9999)	

Address	Parameter name	Setting (monitor) value	Level
0C00	Input type	H'00000000 (0): Pt (–200 to 850°C/–300 to 1500°F) H'00000001 (1): Pt (–199.9 to 500.0°C/–199.9 to 900.0°F) H'00000002 (2): Pt (0.0 to 100.0°C/0.0 to 210.0°F) H'00000003 (3): JPt (–199.9 to 500.0°C/–199.9 to 900.0°F) H'00000004 (4): JPt (0.0 to 100.0°C/0.0 to 210.0°F) H'00000005 (5): K (–200 to 1300°C/–300 to 2300°F) H'00000006 (6): K (–20.0 to 500.0°C/0.0 to 900.0°F) H'00000007 (7): J (–100 to 850°C/–100 to 1500°F) H'00000008 (8): J (–20.0 to 400.0°C/0.0 to 750.0°F) H'00000009 (9): T (–200 to 400°C/–300 to 700°F) H'0000000A (10): T (–199.9 to 400.0°C/–199.9 to 700.0°F) H'0000000B (11): E (0 to 600°C/0 to 1100°F) H'0000000C (12): L (–100 to 850°C/–100 to 1500°F) H'0000000D (13): U (–200 to 400°C/–300 to 700°F) H'0000000E (14): U (–199.9 to 400.0°C/–199.9 to 700.0°F) H'0000000F (15): N (–200 to 1300°C/–300 to 2300°F) H'00000010 (16): R (0 to 1700°C/0 to 3000°F) H'00000011 (17): S (0 to 1700°C/0 to 3000°F) H'00000012 (18): B (100 to 1800°C/300 to 3200°F) H'00000013 (19): Infrared temperature sensor (10 to 70°C) H'00000014 (20): Infrared temperature sensor (60 to 120°C) H'00000015 (21): Infrared temperature sensor (115 to 165°C) H'00000016 (22): Infrared temperature sensor (140 to 260°C)	Initial setting
0C02	Temperature unit	H'00000000 (0): °C H'00000001 (1): °F	
0D2E	Selecting upper/lower limit	H'00000000 (0): Upper limit H'00000001 (1): Lower limit	
0E14	Event input assignment 1	H'00000000 (0): None H'00000001 (1): Reset input H'00000002 (2): Hold/clear input	Advanced function setting
0E16	Event input assignment 2	Same settings as the event input assignment 1.	

Address	Parameter name	Setting (monitor) value	Level
0F00	Alarm 1 type	H'00000000 (0): Alarm function OFF H'00000001 (1): Upper and lower-limit alarm H'00000002 (2): Upper-limit alarm H'00000003 (3): Lower-limit alarm H'00000004 (4): Upper and lower-limit range alarm H'00000005 (5): Upper and lower-limit alarm with standby sequence H'00000006 (6): Upper-limit alarm with standby sequence H'00000007 (7): Lower-limit alarm with standby sequence H'00000008 (8): Absolute-value upper-limit alarm H'00000009 (9): Absolute-value lower-limit alarm H'0000000A (10): Absolute-value upper-limit alarm with standby sequence H'0000000B (11): Absolute-value lower-limit alarm with standby sequence H'0000000C (12): Annunciator	Initial setting
0F02	Alarm 1 latch	H'00000000 (0): OFF H'00000001 (1): ON	Advanced function setting
0F04	Alarm 1 hysteresis	H'00000001 to H'0000270F (0.1 to 999.9)	
0F06	Alarm 2 type	Same settings as the alarm 1 type.	Initial setting
0F08	Alarm 2 latch	H'00000000 (0): OFF H'00000001 (1): ON	Advanced function setting
0F0A	Alarm 2 hysteresis	H'00000001 to H'0000270F (0.1 to 999.9)	
0F0C	Alarm 3 type	Same settings as the alarm 1 type.	Initial setting
0F0E	Alarm 3 latch	H'00000000 (0): OFF H'00000001 (1): ON	Advanced function setting
0F10	Alarm 3 hysteresis	H'00000001 to H'0000270F (0.1 to 999.9)	
0F18	Standby sequence reset	H'00000000 (0): Condition A H'00000001 (1): Condition B	
0F1A	Alarm 1 open in alarm	H'00000000 (0): Close in alarm H'00000001 (1): Open in alarm	
0F1C	Alarm 2 open in alarm	H'00000000 (0): Close in alarm H'00000001 (1): Open in alarm	
0F1E	Alarm 3 open in alarm	H'00000000 (0): Close in alarm H'00000001 (1): Open in alarm	
1006	Automatic display return time	H'00000000 (0): OFF H'00000001 to H'00000063 (1 to 99)	
1010	Additional PV display	H'00000000 (0): OFF H'00000001 (1): ON	
101A	PV change color	H'00000001 (1): RED H'00000002 (2): GRN H'00000003 (3): A.R-G H'00000004 (4): A.G-R H'00000005 (5): L.R-G H'00000006 (6): L.G-R	

Address	Parameter name	Setting (monitor) value	Level
1100	Protocol setting (See note 4.)	H'00000000 (0): CompoWay/F H'00000001 (1): Modbus	Commu- nications setting
1102	Communications unit number (See note 4.)	H'00000000 to H'00000063 (0 to 99)	
1104	Communications baud rate (See note 4.)	H'00000000 (0): 1.2 H'00000001 (1): 2.4 H'00000002 (2): 4.8 H'00000003 (3): 9.6 H'00000004 (4): 19.2 H'00000005 (5): 38.4	
1106	Communications data length (See note 4.)	H'00000007 (7): 7 H'00000008 (8): 8	
1108	Communications stop bits (See note 4.)	H'00000001 (1): 1 H'00000002 (2): 2	
110A	Communications parity (See note 4.)	H'00000000 (0): None H'00000001 (1): Even H'00000002 (2): Odd	
110C	Send data wait time (See note 4.)	H'00000000 to H'00000063 (0 to 99)	
1300	Restart mode	H'00000000 (0): Normal monitor status H'00000001 (1): Limit status (limit output OFF)	
133C	Input error output	H'00000000 (0): OFF H'00000001 (1): ON	
1352	Time selection	H'00000000 (0): Limit output H'00000001 (1): Limit status	

* The alarm function can also be used in Controllers without alarm output terminals. In this case, confirm alarm occurrences via the status data.

Note 1. Not displayed on the Controller display.

Note 2. The “limit over continuation time” is a numerical value that is given according to the display format (hr.mn) in the No. 2 display (0.00 to 99.59 corresponds to H'00000000 (0) to H'000026E7 (9959)). When a limit over has not occurred (i.e., when the No. 2 display is “----”), the value is 0.

Note 3. The “selecting upper/lower limit” parameter is used to determine the value for the “limit over maximum/minimum value” parameter. When a limit over has not occurred (i.e., when the No. 2 display is “----”), the value is refreshed according to the PV. If an input error occurs (i.e., when *5.ERR* is displayed alternately on the No. 2 display), the “limit over maximum/minimum value” will be set to the upper limit or lower limit of the input range for each sensor.

Note 4. After communications parameters have been changed, they are enabled by resetting the Controller.

5.2 Status

The figure below shows the structure of the status data.

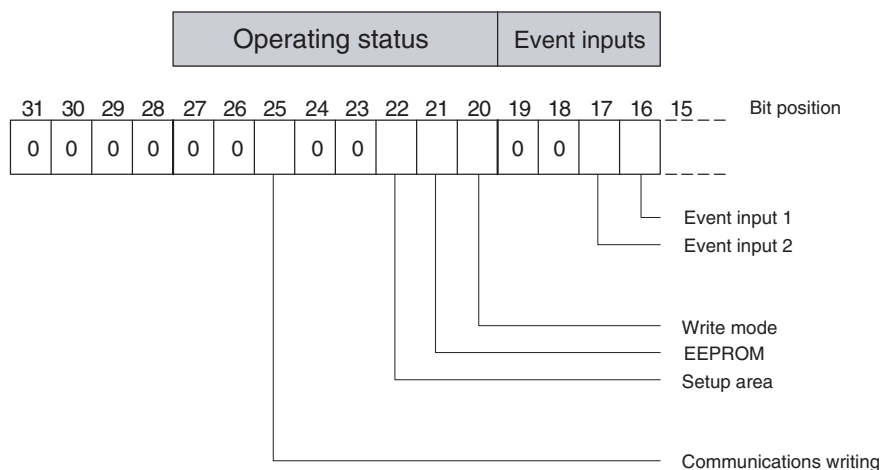
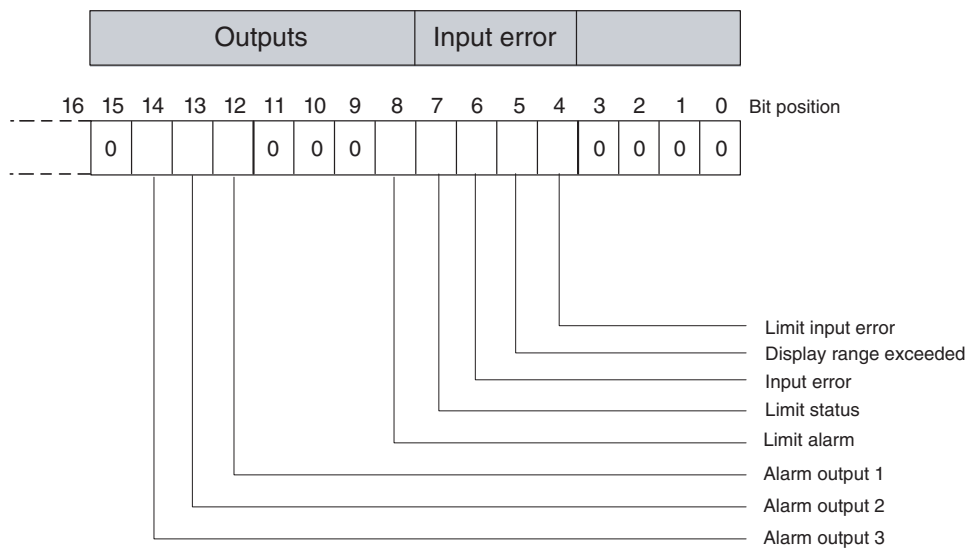

Bit position	Status	Bit Description	
		0	1
0	Spare	OFF	---
1	Spare	OFF	---
2	Spare	OFF	---
3	Spare	OFF	---
4	Limit input error	Not generated	Generated
5	Display range exceeded	Not generated	Generated
6	Input error	Not generated	Generated
7	Limit status	OFF	ON

Bit position	Status	Bit Description	
		0	1
8	Limit alarm	OFF	ON
9	Spare	OFF	---
10	Spare	OFF	---
11	Spare	OFF	---
12	Alarm 1 output	OFF	ON
13	Alarm 2 output	OFF	ON
14	Alarm 3 output	OFF	ON
15	Spare	OFF	---
16	Event input 1	OFF	ON
17	Event input 2	OFF	ON
18	Spare	OFF	---
19	Spare	OFF	---
20	Write mode	Backup mode	RAM write mode
21	EEPROM	RAM = EEPROM	RAM ≠ EEPROM
22	Setup area	Setup area 0	Setup area 1
23	Spare	OFF	---
24	Spare	OFF	---
25	Communications writing	OFF (disabled)	ON (enabled)
26	Spare	OFF	---
27	Spare	OFF	---
28	Spare	OFF	---
29	Spare	OFF	---
30	Spare	OFF	---
31	Spare	OFF	---

Note 1. "Spare" bits are always OFF.

Note 2. The limit input error is the status indicating that an input error has occurred, and shows whether *S.ERR*, *-H \bar{L}* or *-L \bar{O}* is displayed for the limit over maximum/minimum value on the No. 2 display.

Note 3. When the limit alarm is ON, the limit output relay is OFF (limit output status).

Note 4. When read in setup area 1, the status of the bits will be as follows:

- Display range exceeded: Last value held
- Input error: Last value held
- Limit status: Last value held
- Limit input error: Last value held
- Limit alarm: Set (The limit output relay in setup area 1 will turn OFF, so the status is set according to the limit output relay.)
- Alarm outputs: Cleared

Appendix

	ASCII List.....	A-2
--	-----------------	-----

ASCII List

	b8								
	b7	0	0	0	0	1	1	1	1
	b6	0	0	1	1	0	0	1	1
	b5	0	1	0	1	0	1	0	1

	b8	b7	b6	b5	b4	b3	b2	b1
Even parity ↑	0	0	0	0	0	0	0	0
	0	0	0	0	1	0	0	0
	0	0	0	1	0	0	0	0
	0	0	0	1	1	0	0	0
	0	1	0	0	0	0	0	0
	0	1	0	1	0	0	0	0
	0	1	1	0	0	0	0	0
	0	1	1	1	0	0	0	0
	1	0	0	0	0	0	0	0
	1	0	0	0	1	0	0	0
	1	0	1	0	0	0	0	0
	1	0	1	1	0	0	0	0
	1	1	0	0	0	0	0	0
	1	1	0	1	0	0	0	0
	1	1	1	0	0	0	0	0
	1	1	1	1	0	0	0	0

R \ C	0	1	2	3	4	5	6	7
0	NUL	DLE	SPACE	0	@	P	`	p
1	SOH	DC1	!	1	A	Q	a	q
2	STX	DC2	"	2	B	R	b	r
3	ETX	DC3	#	3	C	S	c	s
4	EOT	DC4	\$	4	D	T	d	t
5	ENQ	NAK	%	5	E	U	e	u
6	ACK	SYN	&	6	F	V	f	v
7	BEL	ETB	'	7	G	W	g	w
8	BS	CAN	(8	H	X	h	x
9	HT	EM)	9	I	Y	i	y
A	LF	SUB	*	:	J	Z	j	z
B	VT	ESC	+	;	K	[k	{
C	FF	FS	,	<	L	\	l	
D	CR	GS	-	=	M]	m	}
E	SO	RS	.	>	N	^	n	~
F	SI	US	/	?	O	_	o	DEL

Index

A

addresses
 CompoWay/F, *Part 2 2-7*
 Modbus, *Part 2 4-7*

adjustment level, *Part 1 1-8, Part 1 5-9*
 parameter operation list, *Part 1 A-6*

advanced function setting level, *Part 1 1-8, Part 1 5-21*
 moving to, *Part 1 4-17, Part 1 5-20*
 parameter operation list, *Part 1 A-9*

alarm operation, *Part 1 4-9, Part 1 A-4*
 summary, *Part 1 4-8*

alarms, *Part 1 1-5*
 alarm 1 and 2 outputs
 wiring, *Part 1 2-7*
 alarm hysteresis, *Part 1 4-7*
 alarm latch, *Part 1 4-7*
 alarm outputs, *Part 1 3-9*
 alarm types, *Part 1 3-9*
 alarm values, *Part 1 3-10*
 operation, *Part 1 4-8*

area definitions, *Part 2 2-6*

ASCII list, *Part 1 A-2, Part 2 A-2*

B

BCC, *Part 2 1-3, Part 2 2-2, Part 2 2-3*

C

calibration
 indication accuracy, *Part 1 6-10*
 input types, *Part 1 6-4*
 platinum resistance thermometer, *Part 1 6-8*
 registering calibration data, *Part 1 6-4*
 thermocouple, *Part 1 6-5*
 user calibration, *Part 1 6-4*

characteristics, *Part 1 A-3*

close in alarm, *Part 1 4-8*

cold junction compensator
 connecting, *Part 1 6-5*

command frame
 CompoWay/F, *Part 2 2-2*
 Modbus, *Part 2 4-2*

command text, *Part 2 2-2, Part 2 2-6*

communications
 operation commands, *Part 1 4-22*
 wiring, *Part 1 2-8*

communications baud rate, *Part 2 1-5, Part 2 1-6*

communications data
 CompoWay/F, *Part 2 2-4*
 CompoWay/F and SYSWAY, *Part 2 3-1*

communications data length, *Part 2 1-5, Part 2 1-6*

communications function, *Part 1 1-6*

communications methods, *Part 2 1-2*

communications parameter setup, *Part 2 1-5*

communications parameters, *Part 2 1-5, Part 2 1-6*

communications parity, *Part 2 1-5, Part 2 1-7*

communications protocol, *Part 2 1-5, Part 2 1-6*

communications setting level, *Part 1 1-8, Part 1 5-31*
 parameter operation list, *Part 1 A-10*

communications specifications, *Part 2 1-3*

communications stop bits, *Part 2 1-5, Part 2 1-7*

communications unit number, *Part 2 1-5, Part 2 1-6*

CompoWay/F, *Part 1 1-6, Part 1 2-1, Part 2 1-2, Part 2 2-1*

Controllers with Thermocouple/Resistance Thermometer
 Multi-input, *Part 1 6-3*

CRC-16, *Part 2 4-3*

D

data format
 CompoWay/F, *Part 2 2-2*
 Modbus, *Part 2 4-2*

dimensions, *Part 1 2-2*
 E5CN-FR, *Part 1 2-2*

Display Range Exceeded (error display), *Part 1 A-5*

down key, *Part 1 1-3*

E

Echoback Test
 CompoWay/F, *Part 2 2-8, Part 2 2-14*
 Modbus, *Part 2 4-17*

end code
 CompoWay/F, *Part 2 2-3, Part 2 2-4*

error code, *Part 2 4-5*

error displays
 Display Range Exceeded, *Part 1 A-5*
 Input Error, *Part 1 A-4*
 Memory Error, *Part 1 A-5*

ES1B Infrared Thermosensors, *Part 1 1-5, Part 1 1-6, Part 1 5-16, Part 1 A-12*
 external power supply, *Part 1 1-4, Part 1 1-6, Part 1 2-8, Part 1 2-9, Part 1 A-2*

offset, *Part 1 4-4*
ETX, *Part 2 2-2*
event inputs, *Part 1 1-5, Part 1 2-7, Part 1 4-10*
 wiring, *Part 1 2-7*
external power supply for ES1B, *Part 1 1-4, Part 1 1-6, Part 1 2-8, Part 1 2-9, Part 1 A-2*

F

FINS, *Part 2 1-2, Part 2 2-3*
front panel, *Part 1 1-2*
function code, *Part 2 4-2*
function list, *Part 2 4-6*

I

I/O configuration, *Part 1 1-4*
 E5CN-FR, *Part 1 1-4*
 main functions, *Part 1 1-5*
indication accuracy, *Part 1 6-10*
indicators
 meanings, *Part 1 1-2*
 operation, *Part 1 1-2*
infrared temperature sensor, *Part 1 6-10*
initial setting level, *Part 1 1-8, Part 1 5-15*
 parameter operation list, *Part 1 A-7*
initial setting/communications protect, *Part 1 4-19, Part 1 4-20*
initial settings, *Part 1 3-2*
 examples, *Part 1 3-2*
initialization, *Part 1 5-22*
Input Error (error display), *Part 1 A-4*
input sensor types, *Part 1 1-5, Part 1 5-16*
input shift, *Part 1 4-2*
 one-point shift, *Part 1 4-2*
 two-point shift, *Part 1 4-3*
 calculating, *Part 1 4-4*
input types, *Part 1 3-3, Part 1 A-11*
 default values, *Part 1 5-16*
 list, *Part 1 3-3*
 setting, *Part 1 3-3*
inputs
 wiring, *Part 1 2-6*
installation, *Part 1 2-2, Part 1 2-3*
 removing from case, *Part 1 2-4*
interface, *Part 2 1-4*

K

keys
 down key, *Part 1 1-3*
 key operations, *Part 1 1-7*
 level/reset key, *Part 1 1-3*
 mode key, *Part 1 1-3*
 operations, *Part 1 1-3*
 up key, *Part 1 1-3*

L

level/reset key, *Part 1 1-3*
limit control, *Part 1 3-6*
lower-limit temperature input shift value, *Part 1 5-13*

M

main functions, *Part 1 1-5*
Memory Error (error display), *Part 1 A-5*
Modbus, *Part 2 1-2, Part 2 4-1, Part 2 5-1*
mode key, *Part 1 1-3*
mounting, *Part 1 2-3*
 terminal cover, *Part 1 2-3*
 to panel, *Part 1 2-3*

N

no response
 Modbus, *Part 2 4-5*
No. 1 display, *Part 1 1-2*
No. 2 display, *Part 1 1-2*
node number, *Part 2 2-2*
number of elements
 CompoWay/F, *Part 2 2-7*
 Modbus, *Part 2 4-7*

O

one-point shift, *Part 1 4-4*
open in alarm, *Part 1 4-8*
Operation Command
 CompoWay/F, *Part 2 2-8, Part 2 2-15*
 Modbus, *Part 2 4-14*
operation level, *Part 1 1-8, Part 1 5-6*
 parameter operation list, *Part 1 A-6*
operation/adjustment protect, *Part 1 4-19*

P

- parameter flow, *Part 1 A-13*
- parameter operation list, *Part 1 A-6*
 - adjustment level, *Part 1 A-6*
 - operation level, *Part 1 A-6*
- parameter operation lists
 - advanced function setting level, *Part 1 A-9*
 - communications setting level, *Part 1 A-10*
 - initial setting level, *Part 1 A-7*
 - protect level, *Part 1 A-10*
- parameter structure, *Part 1 6-2*
- parameters
 - additional PV display, *Part 1 5-26*
 - adjustment level display, *Part 1 5-10*
 - alarm 1 hysteresis, *Part 1 5-25*
 - alarm 1 latch, *Part 1 5-27*
 - alarm 1 open in alarm, *Part 1 5-24*
 - alarm 1 type, *Part 1 5-18*
 - alarm 2 hysteresis, *Part 1 5-25*
 - alarm 2 latch, *Part 1 5-27*
 - alarm 2 open in alarm, *Part 1 5-24*
 - alarm 2 type, *Part 1 5-20*
 - automatic display return time, *Part 1 5-26*
 - communications baud rate, *Part 1 5-31*
 - communications data length, *Part 1 5-31*
 - communications parity, *Part 1 5-31*
 - communications stop bits, *Part 1 5-31*
 - communications Unit No., *Part 1 5-31*
 - event input assignment 1, *Part 1 5-23*
 - event input assignment 2, *Part 1 5-23*
 - initial setting/communications protect, *Part 1 4-19, Part 1 4-20, Part 1 5-4*
 - input digital filter, *Part 1 5-25*
 - input error output, *Part 1 5-27*
 - input type, *Part 1 5-16*
 - lower-limit temperature input shift value, *Part 1 5-13*
 - move to advanced function setting level, *Part 1 5-20*
 - move to calibration level, *Part 1 5-30*
 - move to protect level, *Part 1 5-4*
 - operation/adjustment protect, *Part 1 4-19, Part 1 5-4*
 - parameter initialization, *Part 1 5-22*
 - password to move to protect level, *Part 1 5-5*
 - process value, *Part 1 5-7*
 - protocol setting, *Part 1 5-31*
 - PV change color, *Part 1 5-28*
 - selecting, *Part 1 1-9*
 - selecting upper/lower limit, *Part 1 5-17*
 - send data wait time, *Part 1 5-31*
 - setting change protect, *Part 1 4-19, Part 1 4-20, Part 1 5-4*
 - standby sequence reset, *Part 1 5-23*
 - temperature input shift, *Part 1 5-12*
 - temperature unit, *Part 1 5-17*
 - upper-limit temperature input shift value, *Part 1 5-13*
- part names
 - functions, *Part 1 1-2*
- password, *Part 1 4-20, Part 1 4-21*
- PDU structure, *Part 2 2-6*
- platinum resistance thermometer, *Part 1 6-10*
 - calibration, *Part 1 6-8*
- power supply
 - wiring, *Part 1 2-6*
- precautions
 - wiring, *Part 1 2-5*
- process value (PV), *Part 1 5-7*
- protect level, *Part 1 1-8, Part 1 4-19, Part 1 5-3*
 - moving to, *Part 1 4-22, Part 1 5-4*
 - communications operation command, *Part 1 4-22*
 - password, *Part 1 4-20, Part 1 5-5*
 - parameter operation list, *Part 1 A-10*
- protection, *Part 1 4-19*
 - initial setting/communications, *Part 1 4-19, Part 1 4-20, Part 1 5-4*
 - operation/adjustment, *Part 1 4-19, Part 1 5-4*
 - setting change, *Part 1 4-19, Part 1 4-20, Part 1 5-4*
- protocol setting, *Part 2 1-6*
- PV display
 - color change, *Part 1 4-23*

R

- ratings, *Part 1 A-2*
- Read Controller Attributes
 - CompoWay/F, *Part 2 2-8, Part 2 2-12*
- Read Controller Status, *Part 2 2-8, Part 2 2-13*
- Read Variable Area
 - CompoWay/F, *Part 2 2-8, Part 2 2-9*
 - Modbus, *Part 2 4-9*
- removing from case, *Part 1 2-4*
- response code list
 - CompoWay/F, *Part 2 2-18*
- response frame
 - CompoWay/F, *Part 2 2-3*
 - Modbus, *Part 2 4-4*
- RS-485, *Part 2 1-4*

S

send data wait time, *Part 2 1-5, Part 2 1-7*

sensor input

- control range, *Part 1 A-11*
- indication range, *Part 1 A-11*
- setting range, *Part 1 A-11*

sensor types, *Part 1 5-16*

services details

- CompoWay/F, *Part 2 2-9*
- list (CompoWay/F), *Part 2 2-8*
- Modbus, *Part 2 4-9*

set values

- Modbus, *Part 2 4-8*

setting change protect, *Part 1 4-19, Part 1 4-20*

setting level configuration, *Part 1 1-7*

setting levels

- diagram, *Part 1 A-13*

settings

- fixing, *Part 1 1-9*
- password, *Part 1 4-21*

shifting input values, *Part 1 4-2*

SID, *Part 2 2-2, Part 2 2-4*

slave address, *Part 2 4-2*

specifications

- characteristics, *Part 1 A-3*
- ratings, *Part 1 A-2*

standby sequence, *Part 1 4-7*

status, *Part 2 3-7, Part 2 5-7*

STX, *Part 2 2-2*

T

temperature input, *Part 1 1-5*

- shift values, *Part 1 4-6*

temperature unit, *Part 1 1-3, Part 1 3-5*

terminals

- arrangement, *Part 1 2-5*
- wiring, *Part 1 2-5*

thermocouple, *Part 1 6-10*

- calibration, *Part 1 6-5*

transmission procedure, *Part 2 1-3*

two-point shift, *Part 1 4-3, Part 1 4-5, Part 1 4-6*

- calculating, *Part 1 4-4*

type code (variable type), *Part 2 2-7*

U

up key, *Part 1 1-3*

upper/lower limit

- selecting, *Part 1 3-6, Part 1 5-17*

upper-limit temperature input shift value, *Part 1 5-13*

user calibration, *Part 1 6-4*

V

variable area

- Modbus, *Part 2 4-7*

Variable Area (setting range) list

- CompoWay/F and SYSWAY, *Part 2 3-2*
- Modbus, *Part 2 5-2*

variable type, *Part 2 2-7*

W

wiring, *Part 1 2-6, Part 2 1-4*

- alarm outputs 1 and 2, *Part 1 2-7*
- communications, *Part 1 2-8*
- event inputs, *Part 1 2-7*
- inputs, *Part 1 2-6*
- power supply, *Part 1 2-6*
- precautions, *Part 1 2-5*
- terminals, *Part 1 2-5*

Write Variable Area

- CompoWay/F, *Part 2 2-10*
- Modbus, *Part 2 4-11*

Revision History

A manual revision code appears as a suffix to the catalog number on the front cover of the manual.

Cat. No. H133-E1-01

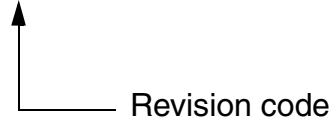

The following table outlines the changes made to the manual during each revision. Page numbers refer to the previous version.

Revision code	Date	Revised content
01	October 2004	Original production

OMRON Corporation
Industrial Automation Company

Industrial Devices and Components Division H.Q.
Measuring Components Department

Shiokoji Horikawa, Shimogyo-ku,
Kyoto, 600-8530 Japan
Tel: (81)75-344-7080/Fax: (81)75-344-7189

Regional Headquarters

OMRON EUROPE B.V.

Wegalaan 67-69, NL-2132 JD Hoofddorp
The Netherlands
Tel: (31)2356-81-300/Fax: (31)2356-81-388

OMRON ELECTRONICS LLC

1 East Commerce Drive, Schaumburg, IL 60173
U.S.A.
Tel: (1)847-843-7900/Fax: (1)847-843-8568

OMRON ASIA PACIFIC PTE. LTD.

83 Clemenceau Avenue,
#11-01, UE Square,
239920 Singapore
Tel: (65)6835-3011/Fax: (65)6835-2711

OMRON CHINA CO., LTD. BEIJING OFFICE

Room 1028, Office Building,
Beijing Capital Times Square,
No. 88 West Chang'an Road,
Beijing, 100031 China
Tel: (86)10-8391-3005/Fax: (86)10-8391-3688

OMRON

Authorized Distributor:

Cat. No. H133-E1-01

E5CN-FR Limit Controller

USER'S MANUAL

OMRON