

Vision Sensor

FZ3 Series

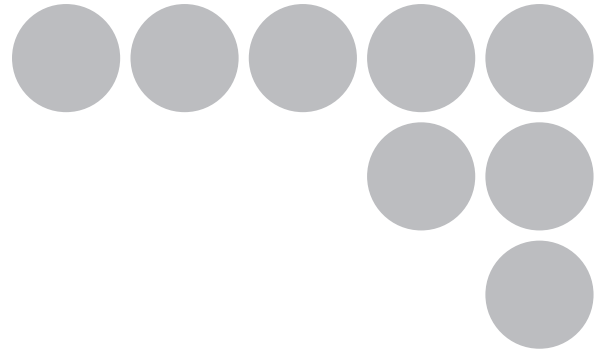

Processing Items List Manual

Introduction

Thank you for purchasing the FZ3 Series.

This manual provides information regarding functions, performance and operating methods that are required for using the FZ3 Series.

When using the FZ3 Series, be sure to observe the following:

- The FZ3 Series must be operated by personnel knowledgeable in electrical engineering.
- To ensure correct use, please read this manual thoroughly to deepen your understanding of the product.
- Please keep this manual in a safe place so that it can be referred to whenever necessary.

Contents

1. Input image	11
Camera Image Input	12
Settings Flow (Camera Image Input)	12
Camera Selection (Camera Image Input)	13
Camera Settings (Camera Image Input)	14
Screen Adjustment Settings (Camera Image Input)	19
White Balance (Camera Image Input)	24
Calibration (Camera Image Input)	26
Additional Explanation (Camera Image Input)	33
Camera Image Input HDR	34
Settings Flow (Camera Image Input HDR)	34
HDR Settings (Camera Image Input HDR)	35
Bright Adjust Setting (Camera Image Input HDR)	38
Camera Image Input HDR Lite	40
Settings Flow (Camera Image Input HDR Lite)	40
HDR setting (Camera Image Input HDR Lite)	41
Screen adjust (Camera Image Input HDR Lite)	43
Camera Switching	44
Camera Selection (Camera Switching)	44
Additional Explanation (Camera Switching)	44
Measurement Image Switching	46
Parameter Settings (Measurement Image Switching)	46
2. Measurement	47
Search	48
Settings Flow (Search)	48
Model Registration (Search)	49
Region Setting (Search)	52
Detection Point (Search)	53
Reference Position (Search)	53
Measurement Parameters (Search)	54
Output Parameters (Search)	56
Key Points for Test Measurement and Adjustment (Search)	56
Measurement Results for Which Output Is Possible (Search)	58
Flexible Search	59
Settings Flow (Flexible Search)	59
Model Registration (Flexible Search)	60
Region Setting (Flexible Search)	63
Measurement Parameters (Flexible Search)	63
Output Parameters (Flexible Search)	65
Key Points for Test Measurement and Adjustment (Flexible Search)	65
Measurement Results for Which Output Is Possible (Flexible Search)	67
Sensitive Search	68
Settings Flow (Sensitive Search)	68
Model Registration (Sensitive Search)	69
Region Setting (Sensitive Search)	72

Detection Point (Sensitive Search)	73
Reference Position (Sensitive Search)	73
Measurement Parameters (Sensitive Search)	74
Output Parameters (Sensitive Search)	75
Key Points for Test Measurement and Adjustment (Sensitive Search)	76
Measurement Results for Which Output Is Possible (Sensitive Search)	78
ECM Search	79
Settings Flow (ECM Search)	79
Model Registration (ECM Search)	80
Error Model Registration (ECM Search)	84
Region Setting (ECM Search)	84
Detection Point (ECM Search)	84
Reference Position (ECM Search)	85
Measurement Parameters (ECM Search)	86
Output Parameters (ECM Search)	87
Key Points for Test Measurement and Adjustment (ECM Search)	88
When Using Measurement Results Externally (ECM Search)	89
EC Circle Search	90
Settings Flow (EC Circle Search)	90
Circle Setting (EC Circle Search)	91
Region Setting (EC Circle Search)	92
Reference Position (EC Circle Search)	93
Color Specification (EC Circle Search)	94
Measurement Parameters (EC Circle Search)	95
Output Parameters (EC Circle Search)	97
Key Points for Test Measurement and Adjustment (EC Circle Search)	98
Measurement Results for Which Output Is Possible (EC Circle Search)	99
Shape Search+	100
Settings Flow (Shape Search+)	101
Model Registration (Shape Search+)	101
Region Setting (Shape Search+)	103
Detection Point (Shape Search+)	103
Reference Position (Shape Search+)	104
Measurement Parameters (Shape Search+)	105
Output Parameters (Shape Search+)	106
Key Points for Test Measurement and Adjustment (Shape Search+)	107
Measurement Results for Which Output Is Possible (Shape Search+)	108
Classification	110
Settings Flow (Classification)	110
Model Registration (Classification)	111
Region Setting (Classification)	115
Measurement Parameters (Classification)	116
Output Parameters (Classification)	117
Key Points for Test Measurement and Adjustment (Classification)	117
Measurement Results for Which Output Is Possible (Classification)	119
Edge Position	120
Settings Flow (Edge Position)	120
Region Setting (Edge Position)	121
Edge Color Specification - For Color Cameras Only (Edge Position)	123

Reference Position (Edge Position)	124
Measurement Parameters (Edge Position)	125
Output Parameters (Edge Position)	128
Key Points for Test Measurement and Adjustment (Edge Position)	129
Measurement Results for Which Output Is Possible (Edge Position)	129
Edge Pitch	130
Settings Flow (Edge Pitch)	130
Region Setting (Edge Pitch).....	131
Edge Color Specification - For Color Cameras Only (Edge Pitch).....	132
Measurement Parameters (Edge Pitch).....	133
Output Parameters (Edge Pitch).....	135
Key Points for Test Measurement and Adjustment (Edge Pitch)	136
Measurement Results for Which Output Is Possible (Edge Pitch).....	137
Scan Edge Position	138
Settings Flow (Scan Edge Position)	138
Region Setting (Scan Edge Position).....	139
Edge Color Specification - For Color Cameras Only (Scan Edge Position).....	141
Reference Position (Scan Edge Position)	142
Measurement Parameters (Scan Edge Position).....	143
Judgment Conditions (Scan Edge Position)	146
Output Parameters (Scan Edge Position)	148
Key Points for Test Measurement and Adjustment (Scan Edge Position)	149
Measurement Results for Which Output Is Possible (Scan Edge Position).....	150
Scan Edge Width	152
Settings Flow (Scan Edge Width)	152
Region Setting (Scan Edge Width).....	153
Edge Color Specification - For Color Cameras Only (Scan Edge Width).....	155
Measurement Parameters (Scan Edge Width).....	156
Judgement Conditions (Scan Edge Width)	159
Output Parameters (Scan Edge Width)	159
Key Points for Test Measurement and Adjustment (Scan Edge Width)	160
Measurement Results for Which Output Is Possible (Scan Edge Width).....	161
Color Data	162
Settings Flow (Color Data)	162
Region Setting (Color Data).....	163
Measurement Parameters (Color Data).....	164
Output Parameters (Color Data).....	166
Key Points for Test Measurement and Adjustment (Color Data)	166
Measurement Results for Which Output Is Possible (Color Data).....	167
Gravity and Area	168
Settings Flow (Gravity and Area)	168
Color Specification (Gravity and Area)	170
Binarization (Gravity and Area)	172
Region Setting (Gravity and Area)	173
Reference Position (Gravity and Area)	174
Measurement Parameters (Gravity and Area)	175
Output Parameters (Gravity and Area)	177
Key Points for Test Measurement and Adjustment (Gravity and Area)	178
Measurement Results for Which Output Is Possible (Gravity and Area).....	178

Labeling	180
Settings Flow (Labeling)	180
Color Specification (Labeling)	181
Binarization (Labeling)	184
Region Setting (Labeling).....	185
Reference Position (Labeling).....	186
Measurement Parameters (Labeling).....	187
Judgement Conditions (Labeling)	190
Output Parameters (Labeling).....	191
Key Points for Test Measurement and Adjustment (Labeling)	192
Measurement Results for Which Output Is Possible (Labeling).....	192
Label Data	194
Settings Flow (Label Data)	195
Setting (Label Data)	195
Output Parameters (Label Data).....	196
Test Measurement (Label Data)	197
Measurement Results for Which Output Is Possible (Label Data).....	197
Labeling+	198
Settings Flow (Labeling+).....	198
Color Specification (Labeling+)	200
Binarization (Labeling+)	202
Region Setting (Labeling+)	204
Reference Position (Labeling+)	205
Extraction Conditions (Labeling+)	206
Measurement Parameters (Labeling+)	208
Judgement Conditions (Labeling+).....	212
Output Parameters (Labeling+)	213
Key Points for Test Measurement and Adjustment (Labeling+).....	214
Measurement Results for Which Output Is Possible (Labeling+)	215
Defect	217
Settings Flow (Defect)	217
Region Setting (Defect)	218
Measurement Parameters (Defect)	219
Output Parameters (Defect).....	223
Key Points for Test Measurement and Adjustment (Defect)	223
Measurement Results for Which Output Is Possible (Defect).....	224
Precise Defect	225
Settings Flow (Precise Defect)	225
Region Setting (Precise Defect)	226
Measurement Parameters (Precise Defect)	227
Output Parameters (Precise Defect)	231
Key Points for Test Measurement and Adjustment (Precise Defect)	231
Measurement Results for Which Output Is Possible (Precise Defect)	232
Fine Matching.....	233
Settings Flow (Fine Matching).....	233
Model Registration (Fine Matching)	235
Difference Image Display (Fine Matching).....	236
Measurement Parameters (Fine Matching)	238
Output Parameters (Fine Matching)	241

Key Points for Test Measurement and Adjustment (Fine Matching)	242
Measurement Results for Which Output Is Possible (Fine Matching)	243
Character Inspection	244
Settings Flow (Character Inspection)	244
Dictionary Parameters (Character Inspection)	245
Region Setting (Character Inspection)	246
Measurement Parameters (Character Inspection)	246
Output Parameters (Character Inspection)	248
Key Points for Test Measurement and Adjustment (Character Inspection)	249
Measurement Results for Which Output Is Possible (Character Inspection)	250
Date Verification	252
Settings Flow (Date Verification)	252
Verification Parameters (Date Verification)	253
Date Parameters (Date Verification)	255
Code Parameters (Date Verification)	256
Output Parameters (Date Verification)	259
Test Measurement (Date Verification)	260
Measurement Results for Which Output Is Possible (Date Verification)	260
Model Dictionary	261
Settings Flow (Model Dictionary)	261
Model Registration (Model Dictionary)	262
Measurement Parameters (Model Dictionary)	265
Model Automatic Registration (Model Dictionary)	266
Key Points for Test Measurement and Adjustment (Model Dictionary)	268
Measurement Results for Which Output Is Possible (Model Dictionary)	268
Barcode+	269
Settings Flow (Barcode+)	269
Region Setting (Barcode+)	270
Measurement Parameters (Barcodes+)	271
Results Settings (Barcode+)	273
Output Parameters (Barcode+)	273
Key Points for Test Measurement and Adjustment (Barcode+)	274
Measurement Results for Which Output Is Possible (Barcodes+)	275
2D Code+	277
Settings Flow (2D Code+)	277
Region Setting (2D Code+)	278
Measurement Parameters (2D Code+)	278
Results Settings (2D Code+)	280
Output Parameters (2D Code+)	280
Key Points for Test Measurement and Adjustment (2D Code+)	281
Measurement Results for Which Output Is Possible (2D Codes+)	282
Circle Angle	284
Settings Flow (Circle Angle)	285
Region Setting (Circle Angle)	286
Output Parameters (Circle Angle)	288
Key Points for Test Measurement and Adjustment (Circle Angle)	288
Measurement Results for Which Output Is Possible (Circle Angle)	289
3. Compensate image	291

Position Compensation	292
Region Compensation (Position Compensation)	293
Scroll Method (Position Compensation)	293
Measurement Results for Which Output Is Possible (Position Compensation)	295
Trapezoidal Correction+	296
Conversion Method (Trapezoidal Correction+)	296
Region Setting (Trapezoidal Correction+)	302
Key Points for Test Measurement and Adjustment (Trapezoidal Correction+)	303
Measurement Results for Which Output Is Possible (Trapezoidal Correction+)	303
Filtering	304
Filtering Parameters (Filtering)	304
Region Setting (Filtering)	308
Background Suppression	309
Filter Setting (Background Suppression)	309
Region Setting (Background Suppression)	311
Measurement Results for Which Output Is Possible (Background Suppression)	311
Color Gray Filter	312
Filter Setting (Color Gray Filter)	312
Extract Color Filter	316
Color Specification (Extract Color Filter)	316
Region Setting (Extract Color Filter)	319
Output Image (Extract Color Filter)	319
Measurement Results for Which Output Is Possible (Extract Color Filter)	320
Anti Color Shading	321
Filter Setting (Anti Color Shading)	321
Region Setting (Anti Color Shading)	323
Key Points for Test Measurement and Adjustment (Anti Color Shading)	323
Measurement Results for Which Output Is Possible (Anti Color Shading)	323
Stripes Removal Filter+	324
Filter Setting (Stripes Removal Filter+)	324
Region Setting (Stripes Removal Filter+)	326
Halation Cut+	327
Filter Setting (Halation Cut+)	327
Measurement Results for Which Output Is Possible (Halation Cut+)	329
Panorama+	330
Camera Placement (Panorama+)	332
Image Combination (Panorama+)	334
Measurement Results for Which Output Is Possible (Panorama+)	335
Polar Transformation	336
Region Setting (Polar Transformation)	336
Measurement Results for Which Output Is Possible (Polar Transformation)	338
4. Support Inspection and Measurement	339
Calculation	340
Settings (Calculation)	340
Output Parameters (Calculation)	342
Layout of Setting Expression Window	343
Expression Usage Examples	346
Key Points for Test Measurement and Adjustment (Calculation)	349

Measurement Results for Which Output Is Possible (Calculation)	350
Line Regression	351
Function Selection (Line Regression)	352
Line 0 (Line Regression)	352
Line 1 (Line Regression)	354
Point (Line Regression)	354
Key Points for Test Measurement and Adjustment (Line Regression)	354
Measurement Results for Which Output Is Possible (Line Regression)	355
Circle Regression	356
Parameter Settings (Circle Regression)	356
Key Points for Test Measurement and Adjustment (Circle Regression)	358
Measurement Results for Which Output Is Possible (Circle Regression)	358
Calibration+	359
Calibration (Calibration+)	359
Measurement Results for Which Output Is Possible (Calibration+)	363
Set Unit Data	364
Parameter Settings (Set Unit Data)	364
Measurement Results for Which Output Is Possible (Set Unit Data)	365
Get Unit Data	366
Parameter Settings (Get Unit Data)	366
Measurement Results for Which Output Is Possible (Get Unit Data)	367
Set Unit Figure	368
Parameter Settings (Set Unit Figure)	368
Key Points for Test Measurement and Adjustment (Set Unit Figure)	372
Measurement Results for Which Output Is Possible (Set Unit Figure)	372
Get Unit Figure	373
Parameter Settings (Get Unit Figure)	373
Key Points for Test Measurement and Adjustment (Get Unit Figure)	373
Measurement Results for Which Output Is Possible (Get Unit Figure)	374
Trend Monitor	376
Measurement Value (Trend Monitor)	377
Display Range (Trend Monitor)	377
Judgement Conditions (Trend Monitor)	380
Measurement History Display (Trend Monitor)	381
Data Save (Trend Monitor)	384
Output Parameters (Trend Monitor)	385
Key Points for Test Measurement and Adjustment (Trend Monitor)	386
Measurement Results for Which Output Is Possible (Trend Monitor)	386
Image Logging	388
Logging Conditions (Image Logging)	388
Save Destination (Image Logging)	389
Key Points for Test Measurement and Adjustment (Image Logging)	390
Measurement Results for Which Output Is Possible (Image Logging)	390
Data Logging	391
Settings (Data Logging)	391
Output Format (Data Logging)	392
Additional Explanation (Data Logging)	394
Measurement Results for Which Output Is Possible (Data Logging)	395
Elapsed Time	396

Measurement Results for Which Output Is Possible (Elapsed Time)	397
Wait	398
Settings (Wait)	398
Focus	399
Measurement Parameters (Focus).....	399
Region Setting (Focus).....	400
Output Parameters (Focus).....	401
Key Points for Test Measurement and Adjustment (Focus)	401
Iris	402
Measurement Parameters (Iris)	402
Region Setting (Iris)	404
Output Parameter (Iris).....	405
Key Points for Test Measurement and Adjustment (Iris).....	405
5. Branch	407
Conditional Branch	408
Conditional Branch	409
Conditional Branch Settings Examples	410
Measurement Results for Which Output Is Possible (Conditional Branch)	412
End	413
DI Branch	415
Settings (DI Branch)	415
Measurement Results for Which Output Is Possible (DI Branch)	416
6. Output result	419
Data Output	420
Settings (Data Output)	420
Output Format (Data Output)	421
Key Points for Test Measurement and Adjustment (Data Output).....	424
Measurement Results for Which Output Is Possible (Data Output)	424
Parallel Data Output	425
Settings (Parallel Data Output)	425
Output Format (Parallel Data Output)	426
Measurement Results for Which Output Is Possible (Parallel Data Output)	427
Parallel Judgement Output	428
Settings (Parallel Judgement Output)	428
Output Parameters (Parallel Judgement Output).....	429
Measurement Results for Which Output Is Possible (Parallel Judgement Output).....	430
Fieldbus Data Output	431
Settings (Fieldbus Data Output)	431
Output Format (Fieldbus Data Output)	432
Key Points for Test Measurement and Adjustment (Fieldbus Data Output).....	432
Measurement Results for Which Output Is Possible (Fieldbus Data Output)	433
7. Display result.....	435
Result Display	436
Result Display	437
Display Image File	441
Select Image (Display Image File)	441

Key Points for Test Measurement and Adjustment (Display Image File)	442
Display Last NG Image	443
NG Error Judgement (Display Last NG Image)	443
Image Saving (Display Last NG Image)	445
Data Saving (Display Last NG Image)	446
Output Parameters (Display Last NG Image)	446
Key Points for Test Measurement and Adjustment (Display Last NG Image)	447
Measurement Results for Which Output Is Possible (Display Last NG Image)	447
Manual Revision History	449
Index	451



How This Manual Is Organized

This manual includes two manuals: the "User's Manual", which describes basic operations and settings for vision sensors, and the "Processing Item List Manual", which describes the setting options for each processing item.

Conventions Used in This Manual

Symbols

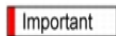
The symbols used in this manual have the following meanings.

	Indicates relevant operational precautions that must be followed.
	Indicates operation-related suggestions from OMRON.

Use of Quotation Marks and Brackets

In this manual, menus and other items are indicated as follows.

[]	Menu	Indicates the menu names or processing items shown in the menu bar.
" "	Item name	Indicates the item names displayed on the screen.

Version Upgrade Information

The newly added functions are described here.

Revision history

Newly added function	Description of newly added functions	Reference in manual
EtherNet/IP	EtherNet/IP communication is now supported. Supported software version: 3.30 or later	Reference: ▶ "User's Manual", "Control/Output via EtherNet/IP" (p.221)
Network drive	Saving to a network drive is now supported. Supported software version: 3.30 or later	Reference: ▶ "User's Manual", "Setting a Network Drive [Network Drive Setting]" (p.151)
Barcode+	Pharmacode was added to the code types readable with Barcodes+. Supported software version: 3.30 or later	Reference: ▶ "Processing Items List Manual", "Barcode+" (p.269)
Camera Image Input HDR	Camera image input HDR is now usable with the FZ3-300/700/900 series. Supported software version: 3.30 or later	Reference: ▶ "Processing Items List Manual", "Camera Image Input HDR" (p.34)
Camera addition	The intelligent compact camera FZ-SQ is now supported. Supported software version: 3.40 or later	Reference: ▶ "User's Manual", "Checking System Configuration" (p.20) Reference: ▶ "Processing Items List Manual", "Camera Image Input" (p.12) Reference: ▶ "Processing Items List Manual", "Camera Image Input HDR Lite" (p.40)
Remote Operation	Remote Operation function to operate a controller from the distant place is now added. Supported software version: 3.52 or later	Reference: ▶ "User's Manual", "Remotely Operating the Controller (Remote Operation)" (p.115)
Scan Edge Position	The parameter name was changed. Supported software version: 3.52 or later	Reference: ▶ "Processing Items List Manual", "Scan Edge Position" (p.138)
Scan Edge Width	The parameter name was changed. Supported software version: 3.52 or later	Reference: ▶ "Processing Items List Manual", "Scan Edge Width" (p.152)

Input image

This chapter describes how to load images from cameras.

- ▶ Reference: Camera Image Input (p.12)
- ▶ Reference: Camera Image Input HDR (p.34)
- ▶ Reference: Camera Image Input HDR Lite (p.40)
- ▶ Reference: Camera Switching (p.44)
- ▶ Reference: Measurement Image Switching (p.46)

Camera Image Input

Set the conditions for loading images from the camera and for storing images of the measured objects. This processing item must be used when measuring.

Used in the Following Case

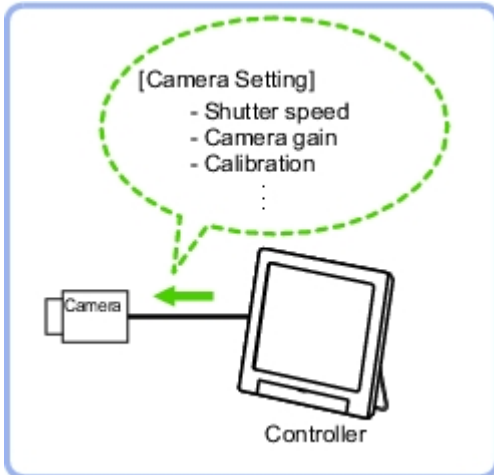

Important

- When using an intelligent camera FZ-SLCx or an auto-focus camera FZ-SZCx, camera image input and camera image input HDR cannot be used together.
- [Camera Image Input] is preset for Unit 0. Do not set any processing item other than camera image input (camera image input HDR, camera image input HDR Lite) for Unit 0.
- When switching from a color camera to a monochrome or switching to a camera with a different resolution, reconfigure the settings in the following units.
- If a camera is connected other than the one for the previous settings, the camera settings are returned to their initial settings.
- It is also possible to set multiple camera image input items to the flow and shoot images at different shutter speeds. However, in this case, if the images are logged, only the last camera image input is logged.

Settings Flow (Camera Image Input)

To set camera image input, follow the steps below.

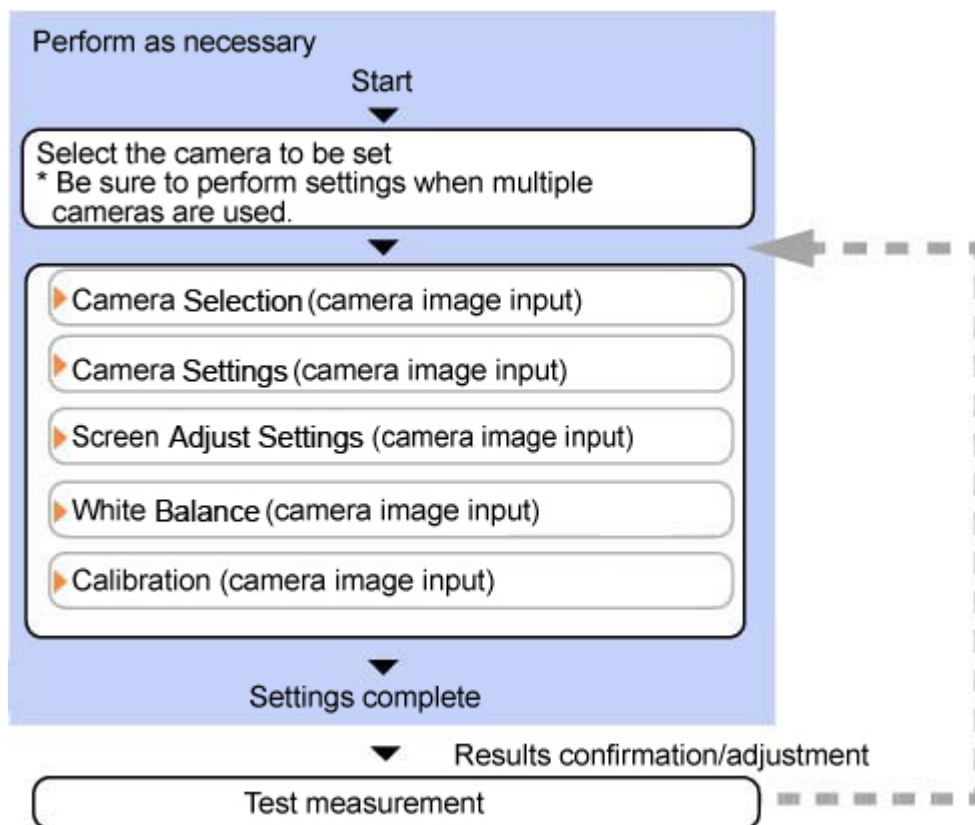

Camera Image Input Item List

Item	Description
Camera 0 to 3	Select the camera to be set.
Select camera	When multiple cameras are connected, select the camera to use for measurement.
Camera setting	Specify the camera settings such as the shutter speed or electronic flash. Reference: ▶ Camera Settings (Camera Image Input) (p.14)
Screen adjust	Adjust the lighting and the lens. Reference: ▶ Screen Adjust Settings (Camera Image Input) (p.19)
White balance	When using a color camera, adjust the white balance. Reference: ▶ White Balance (Camera Image Input) (p.24)
Calibration	Set when measurements (camera coordinate measurement values) are to be output using actual dimensions. Select the calibration setting method and generate the calibration parameters. Reference: ▶ Calibration (Camera Image Input) (p.26)

Camera Selection (Camera Image Input)

When multiple cameras are connected, select the camera to use for measurement.

1. In the item tab area, tap [Select camera].

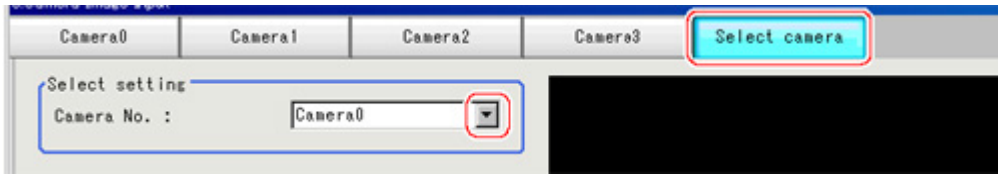

2. Tap [Camera No.] [▼] and select the camera number.
3. If multiple cameras are connected, whether or not to capture images from each camera can be set.

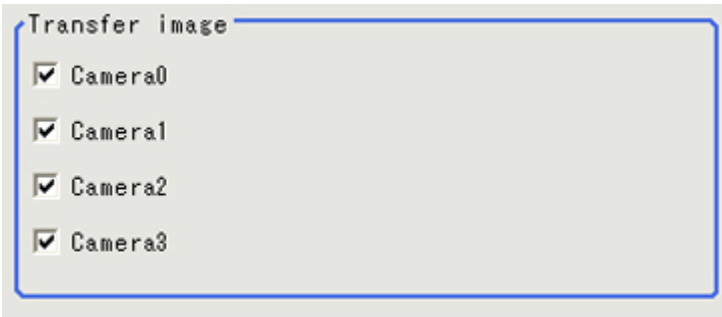

Reference

- The image from the camera selected in [Select camera] will be the object to be measured in the following units.
If you need to switch the camera during the process, insert a [Camera Switching] unit in the scene and switch the image.

Reference: ▶ Camera Switching (p.44)

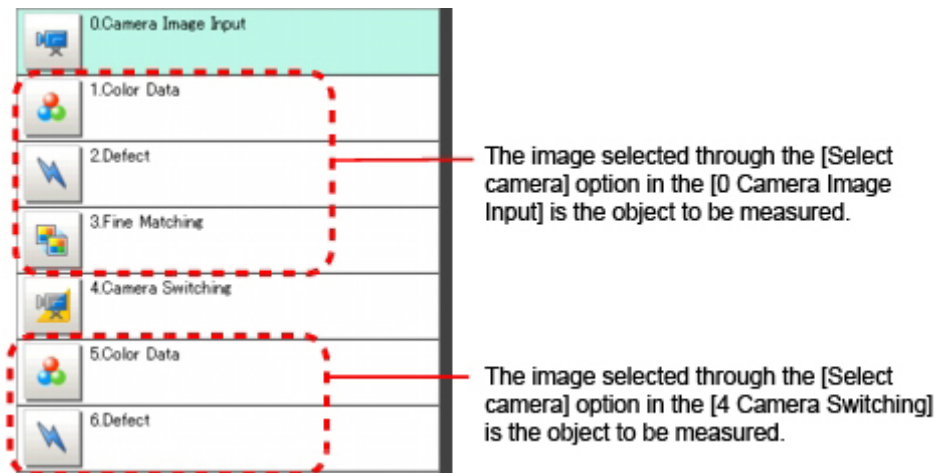

Camera Settings (Camera Image Input)

Set the following photographing conditions for each camera.

- Reference: ▶ Camera Settings (p.15)
- Reference: ▶ Frame/Field - for Monochrome Cameras Only (p.17)
- Reference: ▶ Number of lines to be read (p.17)
- Reference: ▶ Electronic Flash Setting (p.18)

Note

- The displayed items differ depending on the camera type and lighting mode. Perform the following procedure as necessary in accordance with the use environment.

Camera Settings

Adjust the settings related to camera shutter speed and camera gain.

Select the shutter speed appropriate to the speed of the measurement object. Choose a faster shutter speed if the measurement object is moving quickly and the image is blurred.

Adjust the camera gain when images cannot be brightened through the shutter speed, lens aperture, or lighting conditions. Usually, the factory default value can be used.

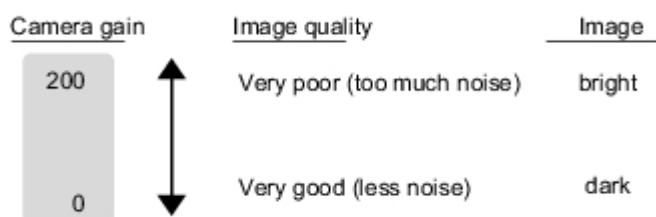

- In the Item Tab area, tap [Camera setting].



- In the "Camera settings" area, specify the shutter speed. The setting methods are to select from the options offered or to set the value directly.



Item	Set value [Factory default]	Description
Shutter speed	<p>For stand-alone cameras</p> <p>Typical value</p> <ul style="list-style-type: none"> • [1/120] (For FZ-SFx, FZ-SPx, FZ-SC2M/FZ-S2M, FZ-SC5M/FZ-S5M) • 1/200 • [1/500] (for FZ-SC/FZ-S, FZ-SLC, FZ-SZC) • 1/1000 • 1/2000 • 1/4000 • 1/8000 • 1/20000 <p>Set by number</p> <ul style="list-style-type: none"> • 1/10 to 1/50000 <p>For intelligent compact cameras</p> <p>Typical value</p> <ul style="list-style-type: none"> • 1/250 • 1/500 • [1/1000] • 1/2000 • 1/4000 • 1/8000 • 1/16000 • 1/30000 <p>Set by number</p> <ul style="list-style-type: none"> • 1/250 to 1/30000 	Option values for the shutter speed differ depending on the camera type.

3. Specify the camera gain while checking the image.

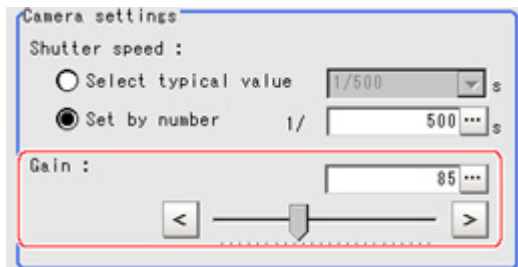

Item	Set value [Factory default]	Description
Gain	<p>0 to 230</p> <p>[50] (For FZ-SFx, FZ-SPx, FZ-SC2M/FZ-S2M, FZ-SC5M/FZ-S5M)</p> <p>[85] (for FZ-Sx, FZ-SLC, FZ-SZC)</p>	Adjust the camera gain when the shutter speed, the lens aperture, and lighting conditions cannot be used to brighten the image. Usually, the factory default value can be used.

Important

- When an intelligent compact camera, FZ-SQ □ □ □ □ , is connected, we recommend setting the gain value to 16 for stable operations. Measurement values may be different if the recommended value is exceeded. Be sure to thoroughly check the measurement result and set the gain value.

Frame/Field - for Monochrome Cameras Only

There are two methods to transfer one image from a camera to the controller: frame read and field read. Frame read is to read all of the scanned lines of the image. The result is called a frame image. Field read is used to read half of the interlaced scanned lines of the image. The result is called the field image. Here, select the unit to be treated as one image.

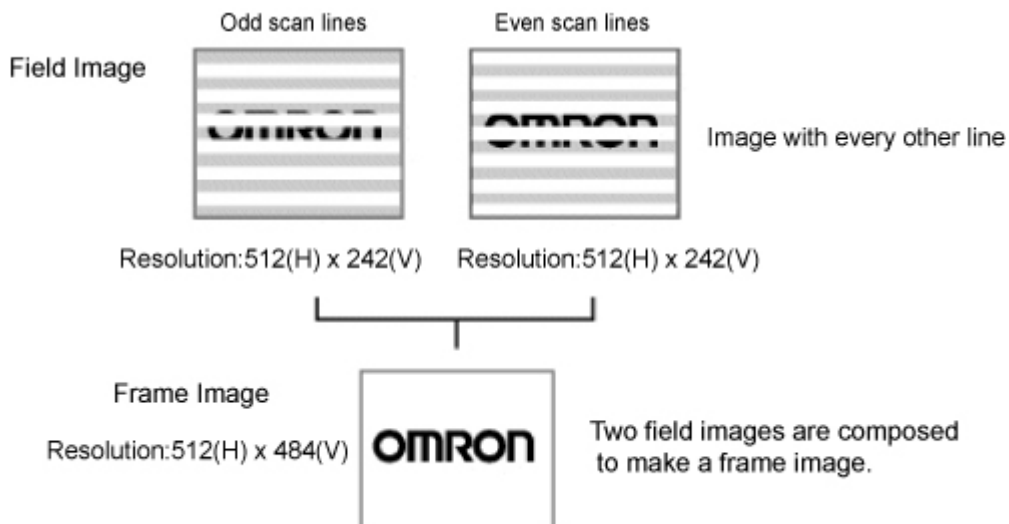

1. In the Item Tab area, tap [Camera setting].
2. In the "Frame/Field" area, select either "Frame" or "Field".

Item	Set value [Factory default]	Description
Frame/Field	[Frame]	Measurements are done in frame units.
	Field	Measurements are done in field units. Select "Field" when you prefer shorter image input time rather than higher accuracy. Processing becomes faster since each image is scanned skipping one scan line per two consecutive lines, but the measurement precision is decreased because the vertical image resolution is lower.

Number of lines to be read

By narrowing the image range to be loaded, the image scan time can be shortened.

Set the range taking the offset of the measurement object into consideration.

The part of the image narrowed down by the start line and the end line will be displayed in the Image

Display area of the processing item setting window or the Main screen.

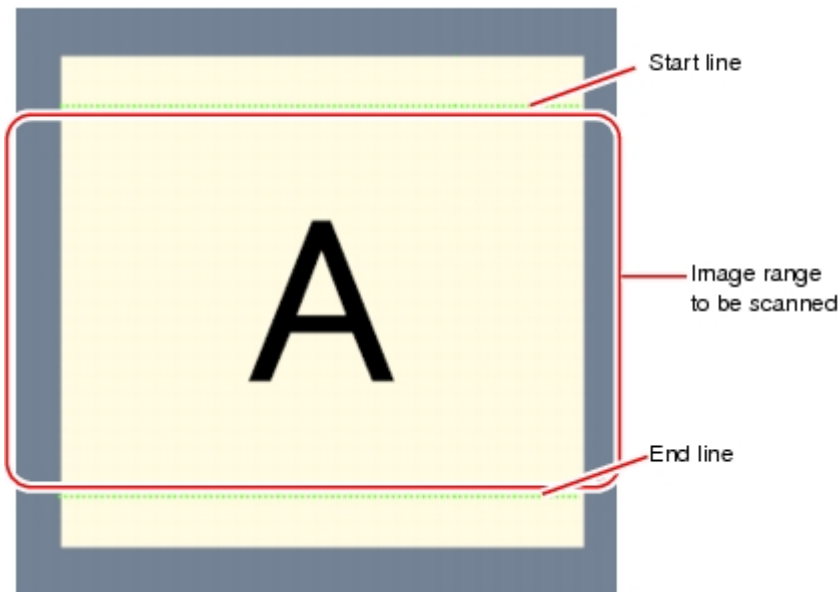

Note

About minimum number of lines

- The minimum number of lines (minimum number of lines between start and end lines) is 12 lines.
- For 5 megapixel cameras, the end line is fixed to 1799.

About coordinate values

- The coordinate values displayed as the measurement results are the values of the display position on the monitor.
- The coordinate values do not vary according to the settings for "Number of lines to be read".

1. In the Item Tab area, tap [Camera setting].



2. Set the start/end line in the "Number of lines to be read" area.

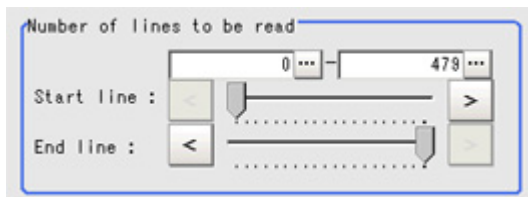

Important

- When the built-in lighting of an FZ-SQ □ □ □ □ is used, it may not be possible to shorten the processing time due to restrictions on the light emission time.

Electronic Flash Setting

This function is set when an electronic flash is used. This sets the output conditions for the signal for synchronizing the measurement and the electronic flash timing.

1. In the Item Tab area, tap [Camera setting].



2. In the "Electronic flash setting" area, specify each item.

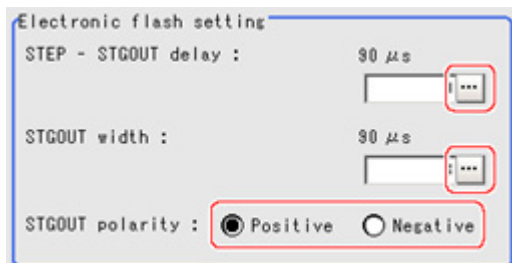

Item	Set value [Factory default]	Description
STEP-STGOUT delay	[0] to 511 (1 count 30μs)	Set the waiting time from the time the STEP signal is input until the electronic flash trigger output signal comes ON. Delay Time=Count x 30μs + 90μs
STGOUT width	1 to 63 [3] (1 count 30μs)	Set the output time for the electronic flash trigger signal.
STGOUT polarity	<ul style="list-style-type: none"> • [Positive] • Negative 	Select the pulse polarity of the electronic flash trigger. Positive polarity: Flashes synchronized with the timing of the electronic flash trigger output signal changing from OFF to ON. Negative: Flashes when the strobe trigger output signal changes from ON to OFF.

Screen Adjustment Settings (Camera Image Input)

Set the lighting and lens conditions for each camera.

- Reference: ▶ Lighting Control (p.19)
- Reference: ▶ Line Bright (p.22)
- Reference: ▶ Lens Adjustment Setting (p.23)
- Reference: ▶ Common Setting for All Cameras (p.24)

Lighting Control

When a camera with a lighting function is connected, the light volume of the lighting can be adjusted from the controller. Brightness can be adjusted automatically or one of the preset patterns can be selected.

A lighting lamp image is displayed as a guide illustration.

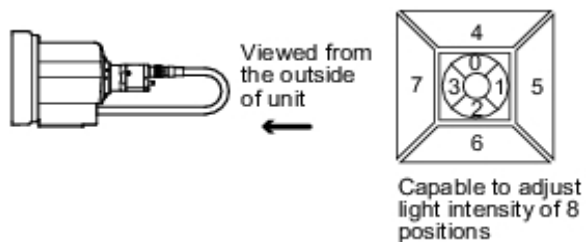

Reference

- When 1 scene contains 2 or more camera image input units, lens setting can be performed only for the first camera image input unit.

1. In the item tab area, tap [Screen adjust].



2. In the "Lighting control" area, specify the brightness.
The image display contents depend on the connected camera.

When an intelligent camera is connected

Important

- When model FZ-SLC15 is connected, only parts 0 to 3 are active. Changing parts 4 to 7 will not affect the light volume of lighting.

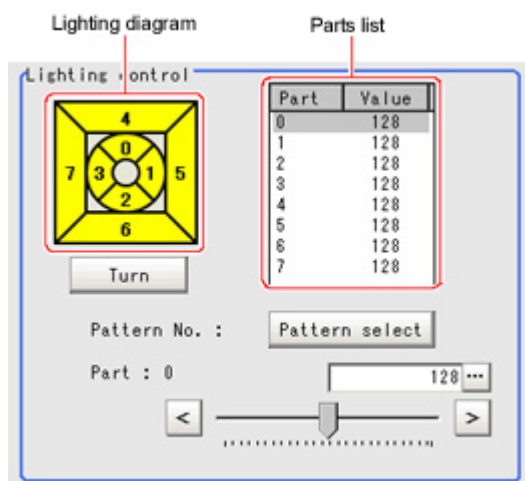

Item	Setting value	Description
Pattern select	Pattern 0 to 16	Can be selected from a preset lighting pattern.
Turn	-	After the camera is installed, if the orientation of the camera does not match the orientation of the lighting parts, tap [Turn] under the lighting diagram. The lighting diagram rotates 90 degrees clockwise each time you tap [Turn].

Brightness at each part	0 to 255 x 8 ch [0]	The light volume at each part can be adjusted to one of 256 levels. 0 indicates the lighting is OFF. The larger the number, the higher the brightness.
-------------------------	------------------------	--

Intelligent compact camera FZ-SQ is connected:

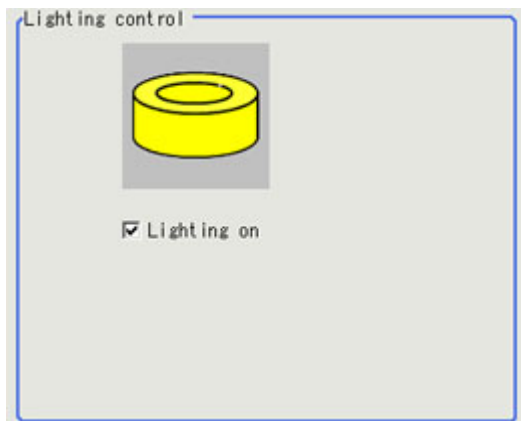

Item	Set value [Factory default]	Description
Lighting on	<ul style="list-style-type: none"> • [Checked] • Unchecked 	Clear the checkbox when no lighting is to be applied.

Important

- When built-in lighting is used, the measurement processing time may be longer in comparison with when lighting is OFF.

Electronic flash controller FZ-LTA100 is connected:

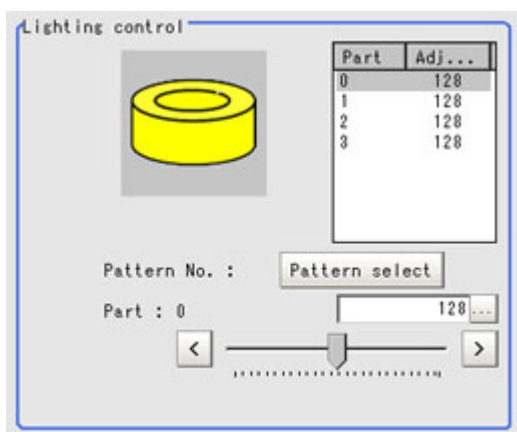

Electronic flash controller FZ-LTA200 is connected:

0 + 1CH are used:

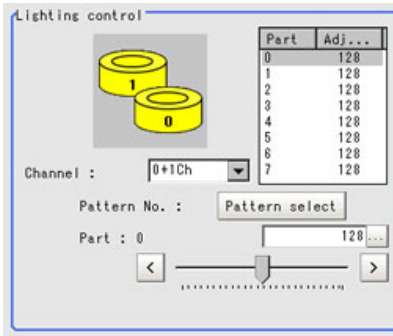

0CH is used:

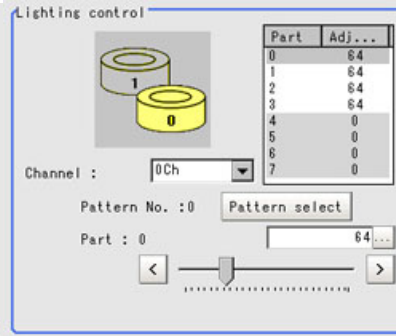

1CH is used:

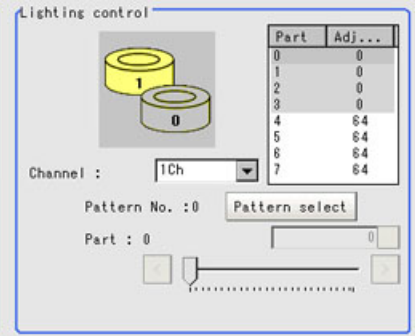

Item	Setting value	Description
Pattern select	Pattern 0 to 16	Can be selected from a preset lighting pattern.
Brightness at each part	0 to 255 [0]	When 1 channel is used, the light volume can be adjusted to one of 256 levels. When 2 channels are used, the light volume can be adjusted to one of 128 levels. The light volume can be adjusted to one of 256 levels. 0 indicates the lighting is OFF. The larger the number, the higher the brightness.

Other cameras are used:

The light volume cannot be adjusted.

Line Bright

The graph showing the gray distribution for 1 line in the image is called the "Line bright". You can display the line brights for R, G and B for any horizontal or vertical line.

1. In the item tab area, tap [Screen adjust].



2. Place a check at "Display line bright".



3. Move the line to the position whose density distribution you want to see.

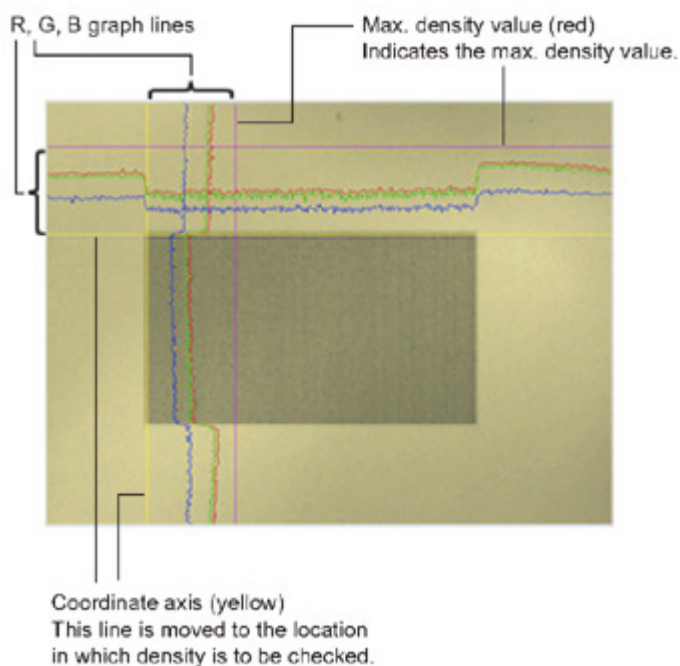

Lens Adjustment Setting

This function is only displayed when an intelligent camera or an auto-focus camera is connected. Make lens adjustments such as the focus and zoom. The optimum value can be set automatically for the focus and iris.

1. In the item tab area, tap [Screen adjust].



2. Specify the "Zoom" size while checking the image.
3. Tap [Auto] at "Focus" and "Iris".
The focus and iris optimized for the zoomed image are set automatically.

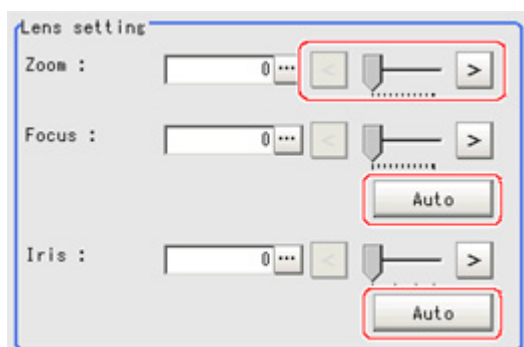

Item	Setting value [Factory default]	Description
Zoom	[0] to 1023	Displays the image zoomed in and out. Depending on the focus setting value, it may not be possible to set a large zoom value.
Focus	[0] to 1023	Adjust the focus. When [Auto] is clicked, the optimum focus for the current image is set automatically.
Iris	[0] to 31	Adjust the light volume that passes through the lens. When [Auto] is clicked, the optimum iris for the current image is set automatically.

Important

- Auto focus and auto iris can only be used when setting with this screen open. They cannot be used during running.

Common Setting for All Cameras

This function is only displayed when an intelligent camera or an auto-focus camera is connected. This sets the conditions for automatically setting the focus, iris, and white balance.

1. In the item tab area, tap [Screen adjust].



2. In the "Common setting for all cameras" area, set up "Camera adjust area" and "Iris base density".

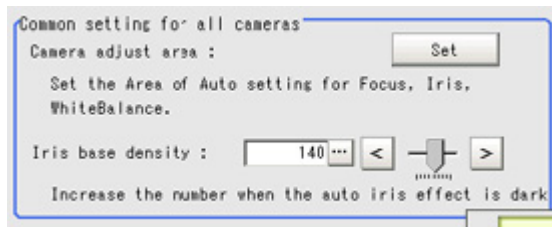

Item	Description
Camera adjust area	This sets the region for judging whether or not the state is appropriate when automatically setting the focus, iris, and white balance.
Iris base density	Increase the number when the auto iris effect is dark.

White Balance (Camera Image Input)

Set the white balance to make white objects look white by calibrating the color of images loaded from cameras.

By adjusting the white balance, the appropriate white color can be reproduced under any lighting conditions

Appropriate values can also be set automatically.

Note

- Perform the white balance setting only when a color camera is used.
- In the following cases, make sure to perform white balance.
 - When a new system is installed
 - When the camera or lighting is changed

Since measurement results may vary with changes of the white balance setting, be sure to verify the operation after it has changed.

1. In the Item Tab area, tap [White balance].

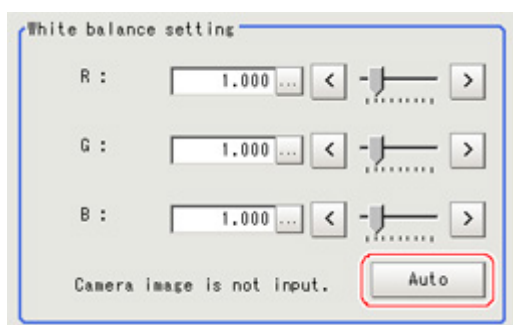

2. Shoot a white piece of paper or cloth.
3. Tap [Auto].

**Note**

- When the "Too bright" or "Too dark" message is displayed, adjust the iris, shutter speed, gain and/or lighting conditions until "Automatic adjustment is possible" is displayed.

4. Adjust the "R", "G" and "B" values as necessary.

Item	Set value [Factory default]	Description
White balance setting	0.001 to 7.999 (R, G, and B) (For intelligent compact cameras 0.001 to 3.000) For FZ-SC [R=1.183] [G=1.000] [B=1.323] For FZ-SC2M [R=1.394] [G=1.000] [B=1.222] For FZ-SFC, FZ-SPC • R [R=1.145] • G [G=1.000] • B [B=1.1889] For FZ-SC5M [R=1.351] [G=1.000] [B=2.314] For intelligent compact cameras [R=1.000] [G=1.040] [B=1.800]	Adjust the white balance. Whiteness increases when the value of "R", "G", and "B" is increased.

Calibration (Camera Image Input)

By setting the calibration, the measurement result can be converted and output as actual dimensions. The calibration method is selected here.

There are three calibration methods, point, sampling, and parameter.

- Reference: ▶ Specifying Points and Setting (Point Specification) (p.26)
- Reference: ▶ Setting calibration through sampling measurement (sampling) (p.28)
- Reference: ▶ Inputting and setting values (Value Setting) (p.31)
- Reference: ▶ View Calibration Parameters (p.32)

Calibration

Reference: ▶ See "User's Manual", "Terminology Explanations" (p.339)

Note

- In order to output measurement results in actual dimensions, set [Calibration] to "ON" in [Output parameter] for each processing unit. If [Calibration] is "OFF" (factory default), measurement results are output as camera image coordinate values.

Specifying Points and Setting (Point Specification)

This is a method for performing calibration by specifying arbitrary points (in pixels).

Calibration parameters are calculated automatically when actual coordinates of specified locations are entered. Up to 3 points can be specified.

- When magnification is the same in the X and Y directions
Specify only 2 points.

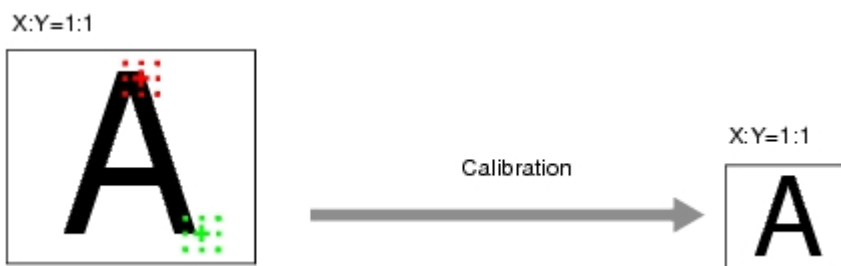

- When magnification is not the same in the X and Y directions Specify 3 points.

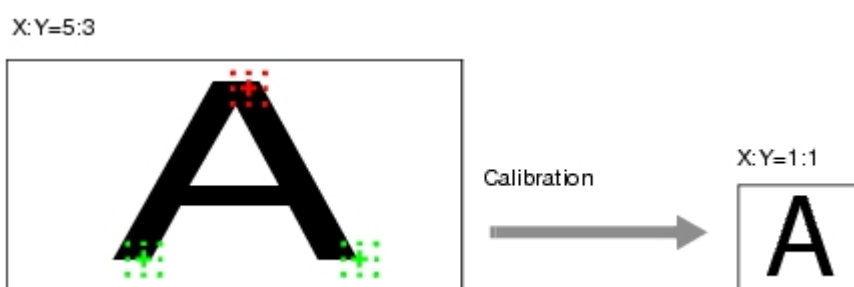

Note

- When 2 points are specified, the coordinate system is set to the left-hand system (forward in the clockwise direction). Specify 3 points to perform calibration including the coordinate system.

- In the Item Tab area, tap [Calibration].



- In the "Calibration setting" area, select "Specify point".



- Tap the first point on the screen.
- Input the actual coordinates for the specified point.
The actual coordinate input window is displayed.

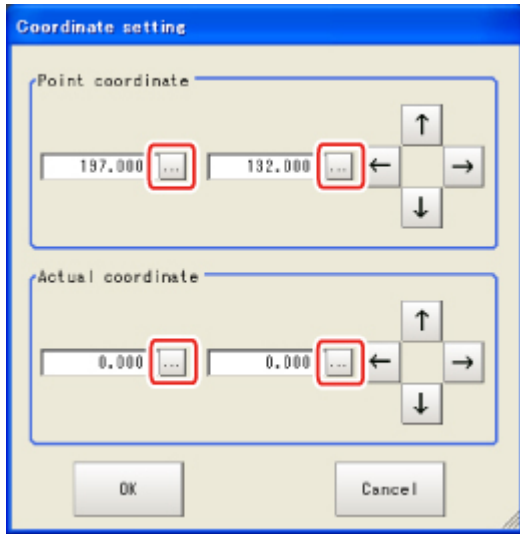

Actual coordinate	Set value [Factory default]
Point X, Y	0 to 9999.9999 [Point you tapped in the window]
Actual X, Y	-99999.9999 to 99999.9999 [0]

- Set the 2nd and 3rd points in the same way.
- Tap [Generate calibration parameters].

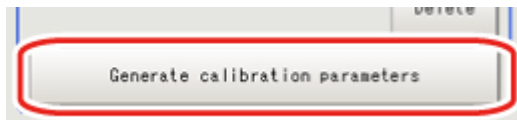

The calibration parameters will be generated.

Setting Calibration through Sampling Measurement (Sampling)

This is a method for setting calibration based on measurement results.

Calibration parameters are calculated automatically when a registered model is searched and the actual coordinates for that position entered.

- In the Item Tab area, tap [Calibration].

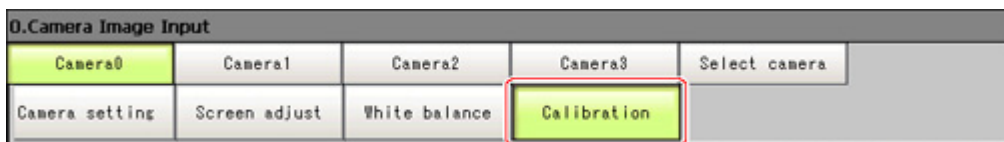

- In the "Calibration setting" area, select "Sampling" .



3. In the "Sampling" area, tap [Regist model].

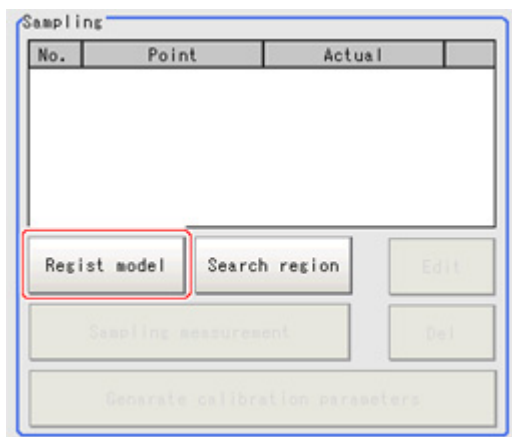

4. Use the Drawing tools to register the model.

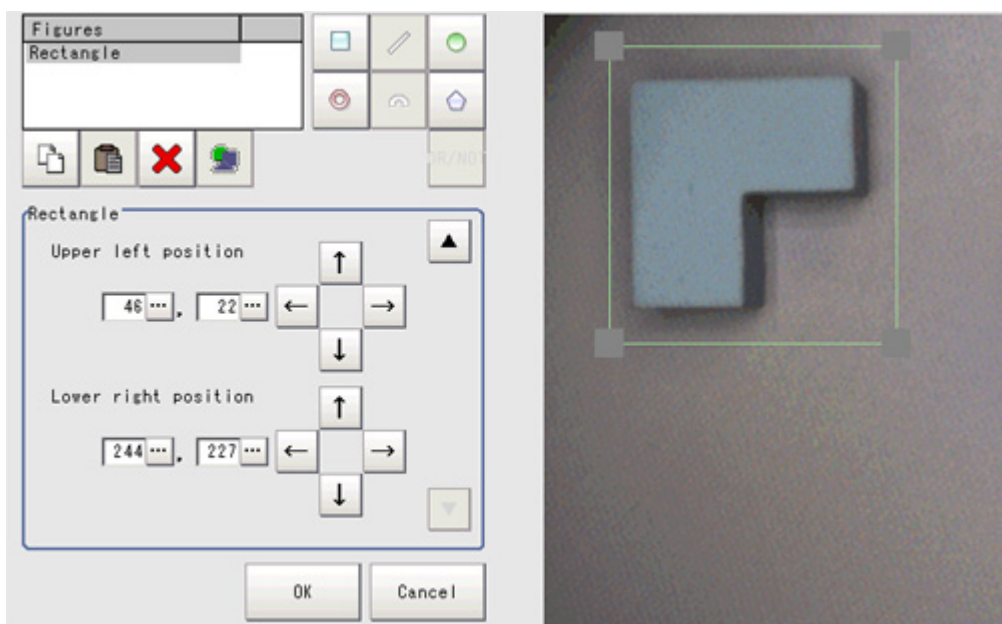

5. Adjust the search region as necessary.
The default value setting is for the entire screen.

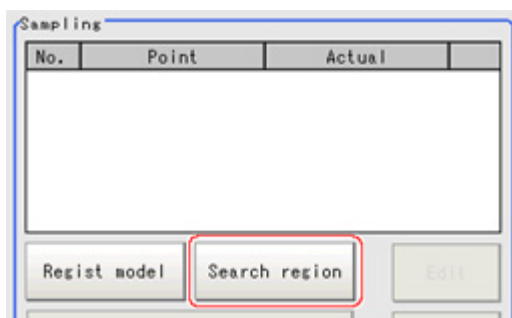

6. Tap [Sampling measurement].

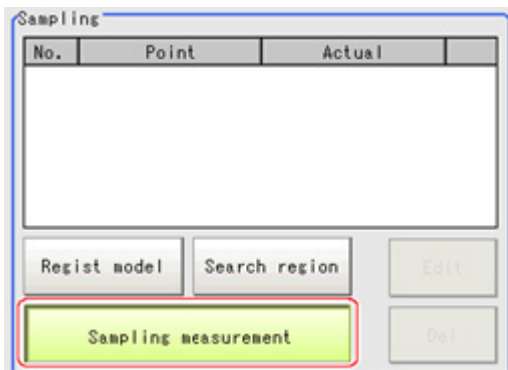

Measurement is performed.

The search result (cross-shaped cursor) is displayed in the Image Display area, and the Sampling Coordinate window is displayed.

7. In the Sampling Coordinate window, enter the X and Y values.

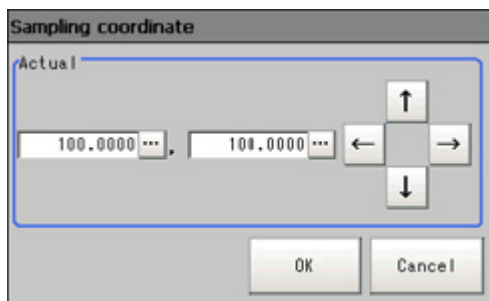

8. Tap [OK].

Point coordinates and actual coordinates are registered in the "Sampling" area.

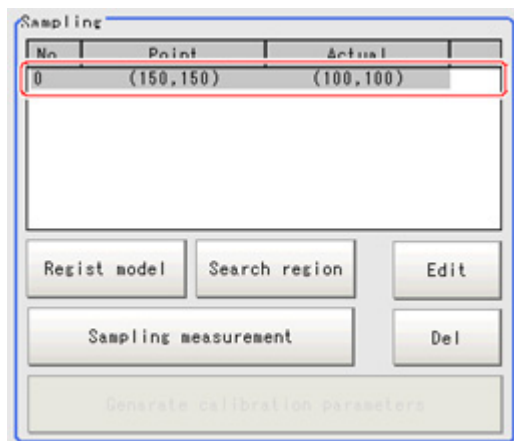

9. Move the object to be measured and repeat the Steps Reference: ▶ 3(p.29) to Reference: ▶ 8(p.30) .
10. Tap [Generate calibration parameters].

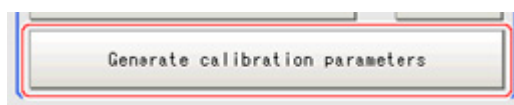

The calibration parameters will be generated.

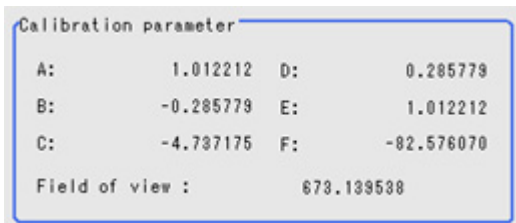

Inputting and Setting Values (Value Setting)

Enter calibration data directly with numerical values.

1. In the Item Tab area, tap [Calibration].



2. In the "Calibration setting" area, select "Parameter".

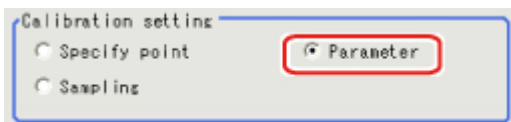

3. In the "Parameter" area, specify values for the "Coordinate", "Origin" and "Magnification".

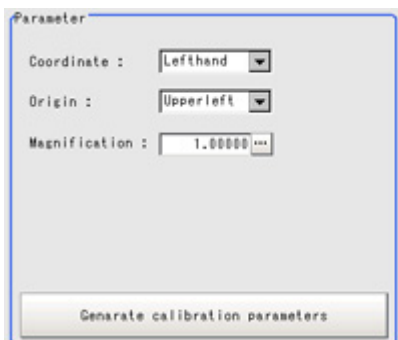

Item	Set value [Factory default]	Description
Coordinate	[Lefthand], Righthand	<p>Left-hand type: Clockwise is forward when specifying the coordinates. Right-hand type: Counter-clockwise is forward when specifying the coordinates.</p> <p>Lefthanded</p> <p>Righthanded</p>

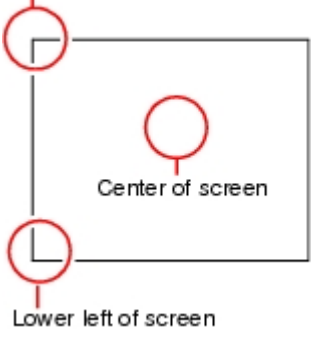
Origin	[Upperleft], Lowerleft, Center	Select where the origin of the actual coordinates will be. Upper left of screen  Lower left of screen
Magnification	0.00001 to 9.99999	Specify the ratio of 1 pixel to the actual dimensions.

4. Tap [Generate calibration parameters].

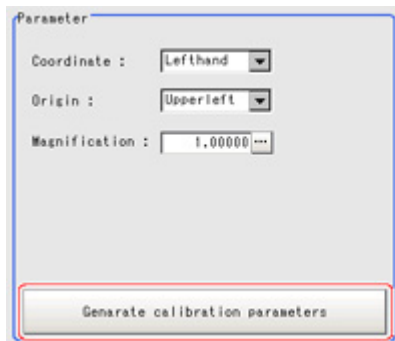

The calibration parameters will be generated.

View Calibration Parameters

View the set calibration data.

1. In the Item Tab area, tap [Calibration].
2. In the "Calibration parameter" area, confirm the calibration data.

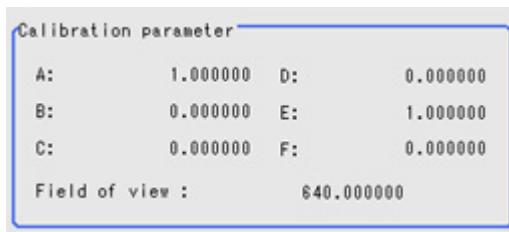

Item	Set value	Description
A	Calculation value	These are calibration conversion values. Camera coordinates are converted to actual coordinates based on these values. The conversion formulas for actual coordinates are as follows: <ul style="list-style-type: none"> • (X, Y): Measurement point (camera coordinates), Unit: pix • (X', Y'): Conversion point (actual coordinates) $X' = A \times X + B \times Y + C$ $Y' = D \times X + E \times Y + F$
B	Calculation value	
C	Calculation value	
D	Calculation value	
E	Calculation value	
F	Calculation value	

Field of view	Calculation value	This is an actual dimension in the X direction.
---------------	-------------------	---

Additional Explanation (Camera Image Input)

Position Compensation and Camera Image Input

When creating a scene, if a [Camera Image Input] unit is positioned after a [Position Compensation] processing unit, that [Position Compensation] unit will be cancelled, which will cause a new image to be read.

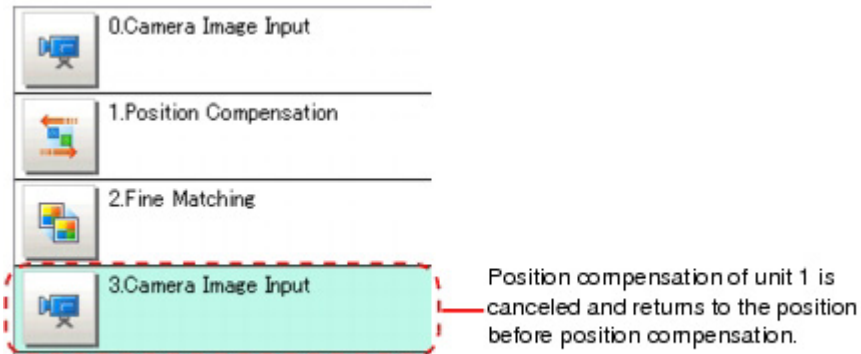

Camera Image Input HDR

You can acquire a wide dynamic range image by combining images photographed consecutively at different shutter speeds.

With objects that generate halation, images with low-contrast, and environments with fluctuation in the lighting, this processing item is an effective substitute for camera image input.

Used in the Following Case

- To acquire stable images of objects for which halation occurs easily

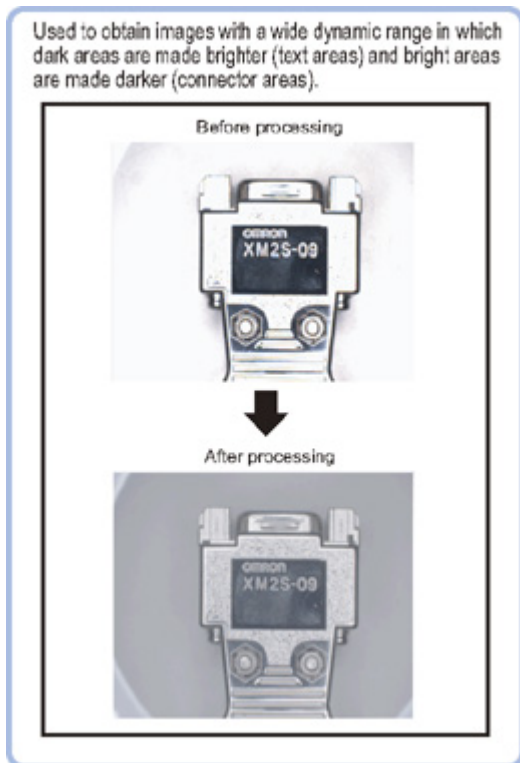

- To measure images with low-contrast stably
Use high-contrast mode.

Important

- [Camera Image Input] is preset for Unit 0. Do not set any processing item other than camera image input (camera image input HDR, camera image input HDR Lite) for Unit 0.
- When using an intelligent camera FZ-SLCx or an auto-focus camera FZ-SZCx, camera image input and camera image input HDR cannot be used together.

Settings Flow (Camera Image Input HDR)

To set camera image input HDR, follow the steps below.

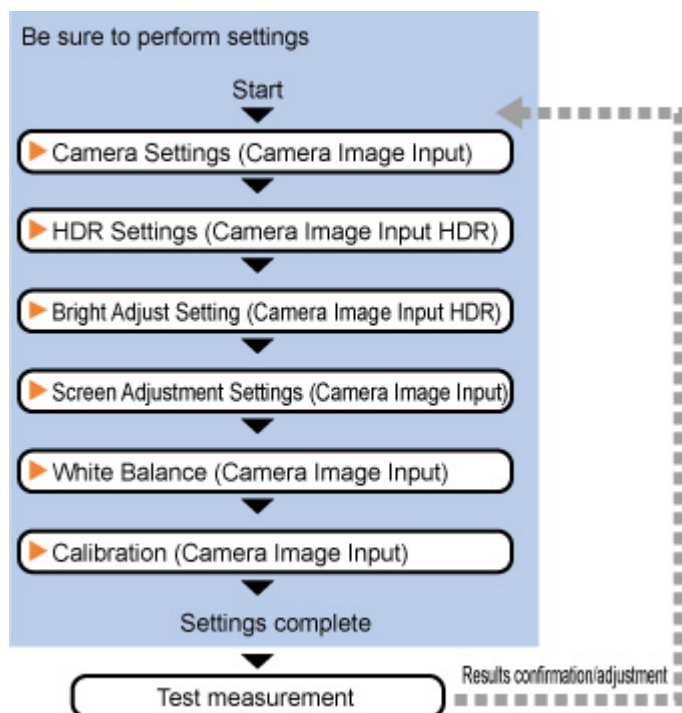

Camera Image Input HDR Item List

Item name	Description
Camera setting	Specify the camera settings such as the electronic flash. The setting method is the same as for [Camera Image Input].Please check it. Reference: ▶ Camera Settings (Camera Image Input) (p.14)
HDR setting	Carry out the image combination and photography settings. Reference: ▶ HDR Settings (Camera Image Input HDR) (p.35)
Bright adjust	Specify the brightness follow-up adjustment setting. Reference: ▶ Bright Adjust Setting (Camera Image Input HDR) (p.38)
Screen adjust	Adjust the lighting and the lens. The setting method is the same as for [Camera Image Input].Please check it.However, the iris cannot be adjusted. Reference: ▶ Screen Adjust Settings (Camera Image Input) (p.19)
White balance	When using a color camera, adjust the white balance. The setting method is the same as for [Camera Image Input].Please check it. Reference: ▶ White Balance (Camera Image Input) (p.24)
Calibration	Set when measurements (camera coordinate measurement values) are to be output using actual dimensions. Select the calibration setting method and generate the calibration parameters. The setting method is the same as for [Camera Image Input].Please check it. Reference: ▶ Calibration (Camera Image Input) (p.26)

HDR Settings (Camera Image Input HDR)

Specify the image combination method etc.

1. In the Item Tab area, tap [HDR setting].
2. In the "Mode select" area, specify the mode.

When you select the mode in the "Mode select" area and specify the measurement region on the image, the parameters are set automatically. To finely adjust the parameters, refer to the next items.



Item	Set value [Factory default]	Description
Mode select	[HDR mode]	Generate images with stable brightness by shooting multiple images with different shutter times based on the specified brightness range.
	High contrast mode	This is used to improve the contrast within an image. Specify the average brightness and brightness range, fix the shutter time, shoot multiple images, and generate images with good contrast.

- In the "Image input setting" area, set the items.
A brightness histogram is displayed as the graph.

HDR

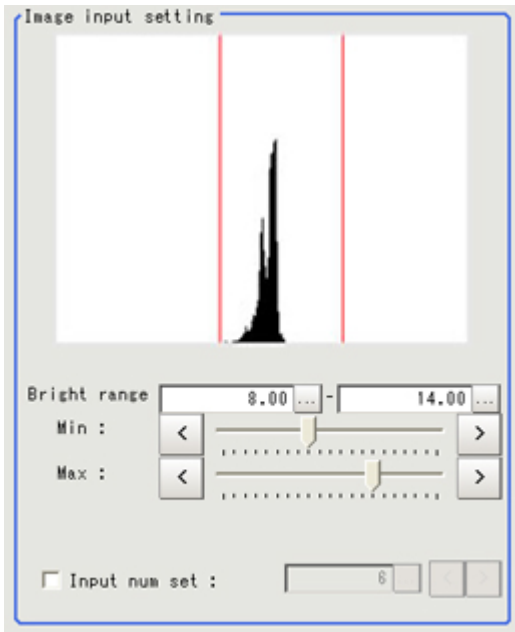

Item	Set value [Factory default]	Description
Minimum brightness	0 to 20 [8]	This item sets the minimum brightness for combining images.
Maximum brightness	0 to 20 [14]	This item sets the maximum brightness for combining images.
Input number setting	<ul style="list-style-type: none"> · [Unchecked] · Checked 2 to 16 [6]	Place a check to set the number of shots manually. Setting a high shot count provides images with low noise. However, more processing time is required. Setting a low shot count shortens the processing time. However, the image is more easily affected by noise.

High contrast mode

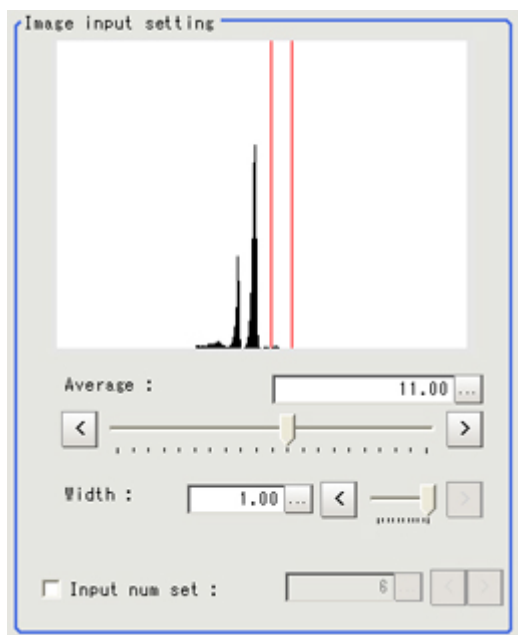

Item	Set value [Factory default]	Description
Average	1.00 to 20.00 [11.00]	Specify the average brightness for images shot.
Width	0.01 to 1.00 [1.00]	Specify the brightness range for images shot.
Input number set	<ul style="list-style-type: none"> · [Unchecked] · Checked 2 to 16 [6]	Place a check to set the number of shots manually. Setting a high shot count provides images with low noise. However, more processing time is required. Setting a low shot count shortens the processing time. However, the image is more easily affected by noise.

4. In the "Output setting" area, set the combination method.



Item	Set value [Factory default]	Description
Type of image combination	[Normal]	Select the combination method.
	Color	Normal: Standard combination method. This compensates the brightness so that dark sections on the combination image do not become all black.
	Linear	Color: This is suitable for inspecting labeling and the Gravity and Area. This compensates the saturation when there is little hue information in the combined image. Linear: This is suitable for fine matching and defect inspection. In order to output the actual brightness of the workpiece, no compensation is performed.

The current shot count and image combination time for the settings are displayed.

Bright Adjust Setting (Camera Image Input HDR)

This sets how far to track the brightness of the loaded images.

1. In the Item Tab area, tap [Brightness adjustment].
2. Set each item in the "Bright adjust setting" area.

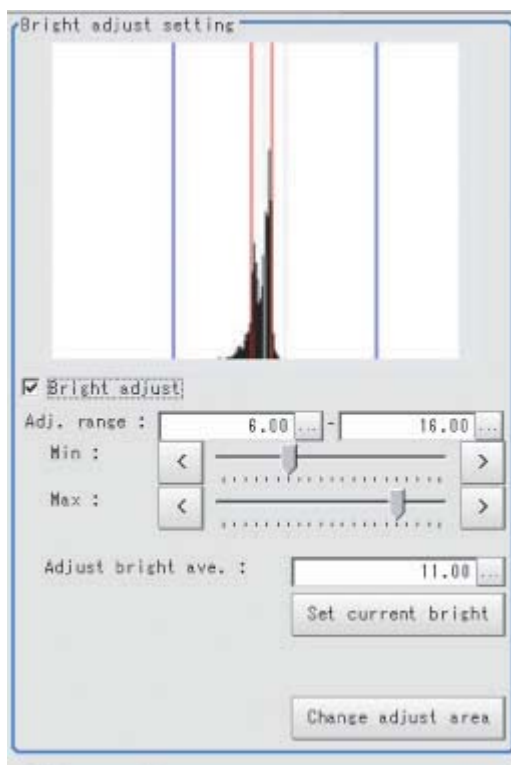

Item	Set value [Factory default]	Description
Brightness adjustment	[Unchecked] Checked	If a check is placed at "Brightness adjustment", the image is output with its brightness automatically compensated. This makes it possible to obtain images with stable brightness even if the lighting conditions fluctuate, for example due to interfering light.
Minimum Adjustment range	0.00 to 20.00 [6.00]	Specify the follow-up brightness minimum value.
Maximum Adjustment range	0.00 to 20.00 [16.00]	Specify the follow-up brightness maximum value.
Adjust bright ave.	0.00 to 20.00 [11.00]	Specify the target for brightness follow-up. Tapping the [Set current bright] button updates this value.

When a check is placed at "Brightness adjustment", the Brightness Adjustment range is displayed with blue lines in the "Histogram" area.

Change the "Adjust bright ave." and brightness adjust area.

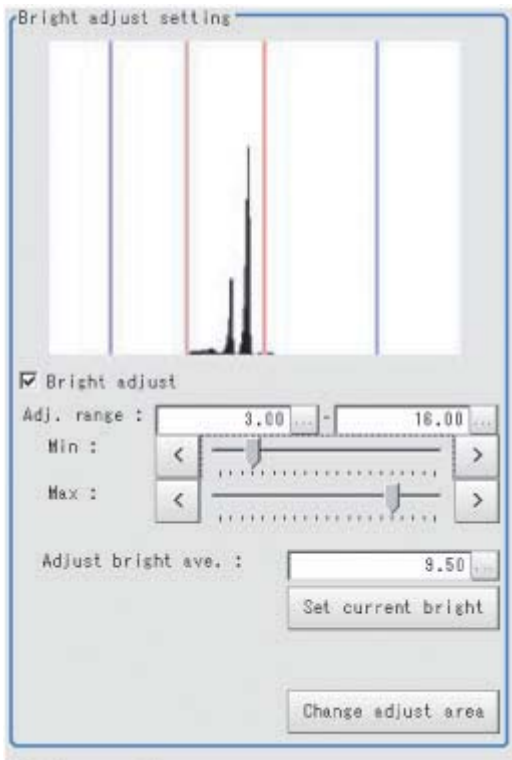

Camera Image Input HDR Lite

This is a processing item specific to the intelligent compact camera.

You can acquire a wide dynamic range image by combining images photographed consecutively at different shutter speeds.

With objects that generate halation, images with low-contrast, and environments with fluctuation in the lighting, this processing item is an effective substitute for camera image input.

Used in the Following Case

- To acquire stable images of objects for which halation occurs easily

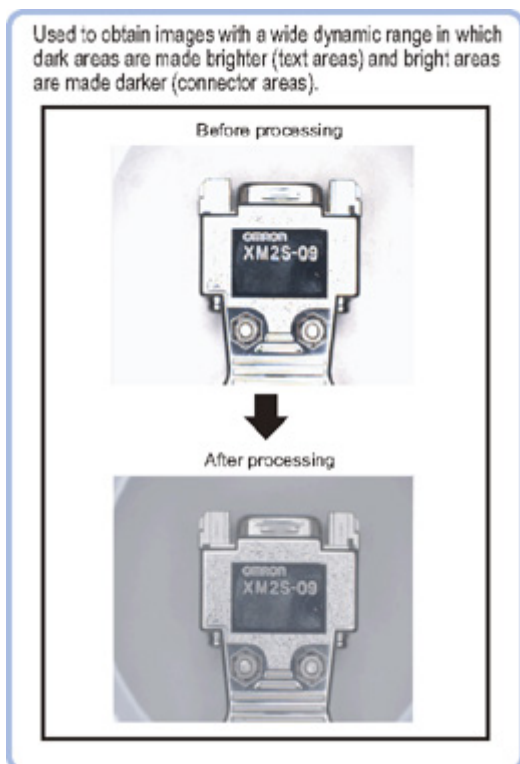

Important

- [Camera Image Input] is preset for Unit 0. Do not set any processing item other than camera image input (camera image input HDR, camera image input HDR Lite) for Unit 0.

Settings Flow (Camera Image Input HDR Lite)

To set Camera Image Input HDR Lite, follow the steps below.

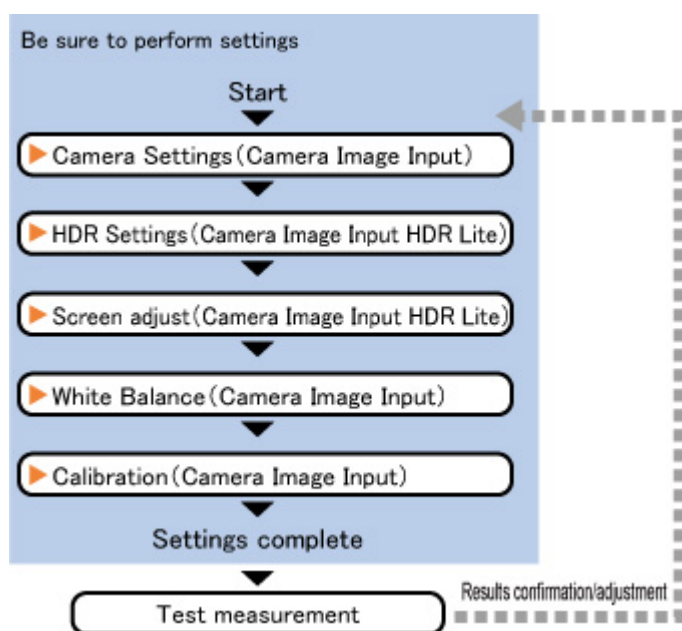

Camera Image Input HDR Lite Item List

Item name	Description
Camera setting	Specify the camera settings such as the electronic flash. The setting method is the same as for [Camera Image Input].Please check it. Reference: ▶ Camera Settings (Camera Image Input) (p.14)
HDR setting	Specify the dynamic range and brightness setting. Specify the HDR automatic setting as necessary. Reference: ▶ HDR setting (Camera Image Input HDR Lite) (p.41)
Screen adjust	Adjust the image with or without the light adjustment or using display line bright. Reference: ▶ Screen adjust (Camera Image Input HDR Lite) (p.42)
White balance	When using a color camera, adjust the white balance. The setting method is the same as for [Camera Image Input].Please check it. Reference: ▶ White Balance (Camera Image Input) (p.24)
Calibration	Set when measurements (camera coordinate measurement values) are to be output using actual dimensions. Select the calibration setting method and generate the calibration parameters. The setting method is the same as for [Camera Image Input].Please check it. Reference: ▶ Calibration (Camera Image Input) (p.26)

HDR setting (Camera Image Input HDR Lite)

Specify the dynamic range and brightness settings.

1. In the Item Tab area, tap [HDR Setting].

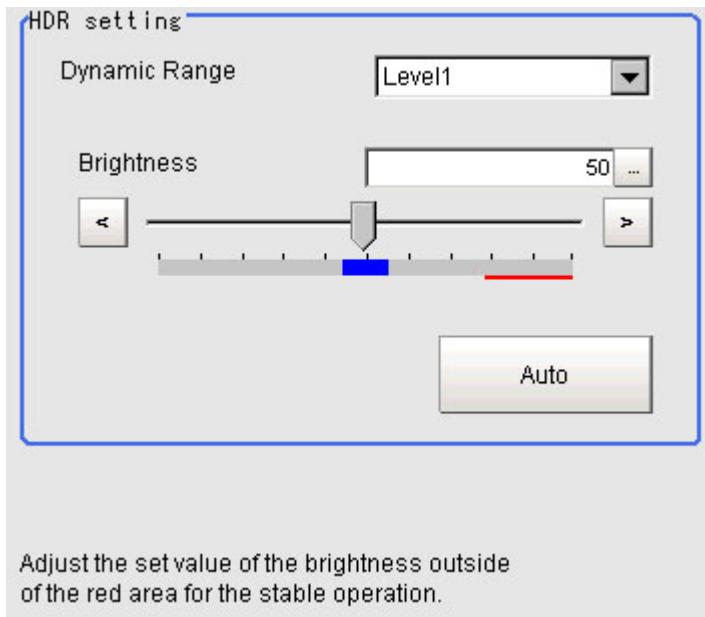

2. When automatic is tapped, the dynamic range and the brightness will be automatically set. If automatic does not produce the desired result, manually adjust the dynamic range and brightness in the HDR settings.

Item	Set value [Factory default]	Description
Dynamic Range	[Level1] to Level4	Specify a dynamic range. The larger the value is, the broader the dynamic range to be combined will be.
Brightness	1 to 100	Specify the brightness settings. The larger the value is in this setting, the longer the exposure time will be. When using a high-speed line, check to make sure that there is no image blur in an actual environment. The degree of image blur can be lowered by decreasing the brightness even when the movement speed of the object is fast.

- Correlation between the level and the dynamic range

The larger the value of the level is, the larger the dynamic range to be combined will be, as illustrated below.



Important

- For stable operations, we recommend setting the brightness within the range where the blue bar does not enter the red region. Measurement values may be different if the recommended range is exceeded. Be sure to thoroughly check the measurement result and set the brightness value.

Screen adjust (Camera Image Input HDR Lite)

Specify the camera image input HDR Lite lighting and the line bright display settings. Specify whether or not to use the lighting. The setting method for line bright is the same as for [Camera Image Input]. Please check it.

- Reference: ▶ Line Bright (Camera Image Input) (p.22)

1. In the Item Tab area, tap [Screen adjust].

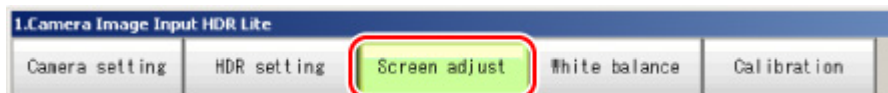

2. Set [Lighting control] as necessary.

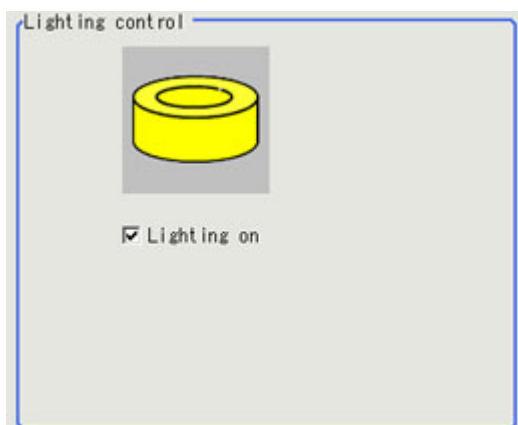

Item	Set value [Factory default]	Description
Lighting on	<ul style="list-style-type: none"> • [Checked] • Unchecked 	Clear the checkbox when no lighting is to be applied.

Camera Switching

Used in the Following Case

- When switching to images on cameras other than that has been set to [Camera Image Input] during scene processing

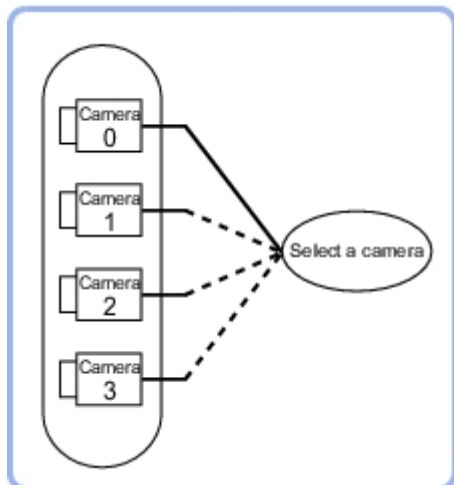

Important

- When switching from a monochrome camera to color camera, reconfigure the settings in the following units.
- Camera switching cannot be used with camera image input HDR.

Camera Selection (Camera Switching)

1. Select the cameras used for measurement.

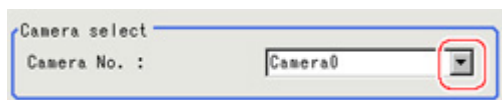

2. Tap [OK].
The settings are finalized.

Additional Explanation (Camera Switching)

When creating a scene, [Position Compensation] will be disabled if [Camera Switching] is positioned after a [Position Compensation] unit, and this will restore the image of the measurement object to its former state before the position compensation was applied.

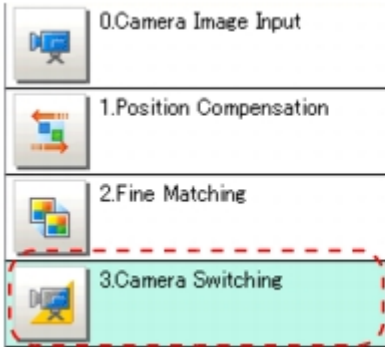

The Position Compensation for Unit 1 is being cancelled, making it restore to its former state before the Position Compensation was applied.

Measurement Image Switching

This sets the output image for the specified image conversion related processing items as the input image for the processing items set in the flow from this processing item onward.

This is primarily used to return converted images back to their originals and to increase the images that can be selected as conversion targets for image conversion related processing items by placing before the image conversion related processing items.

Used in the Following Case

- To return a converted image to its original

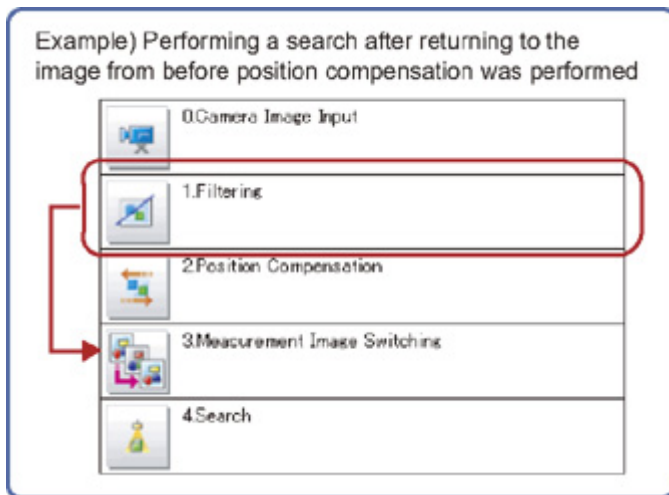

Parameter Settings (Measurement Image Switching)

Specify the processing unit outputting the images to display.

1. Select the target unit in the "Target" area.



Note

- If <Nothing> is left selected, the measurement image switching measurement result is NG. Be sure to set something other than <Nothing>.
- Only an image conversion related unit prior to this unit can be selected.

2. Tap [OK].
The settings are finalized.

Measurement

This chapter describes how to set up the processing items that execute measurement. In addition, key points for adjustment addressing unstable measurement results and shortening measurement time will also be introduced.

- ▶ Reference: Search (p.48)
- ▶ Reference: Flexible Search (p.59)
- ▶ Reference: Sensitive Search (p.68)
- ▶ Reference: ECM Search (p.79)
- ▶ Reference: EC Circle Search (p.90)
- ▶ Reference: Shape Search+ (p.100)
- ▶ Reference: Classification (p.110)
- ▶ Reference: Edge Position (p.120)
- ▶ Reference: Edge Pitch (p.130)
- ▶ Reference: Scan Edge Position (p.138)
- ▶ Reference: Scan Edge Width (p.152)
- ▶ Reference: Color Data (p.162)
- ▶ Reference: Gravity and Area (p.168)
- ▶ Reference: Labeling (p.180)
- ▶ Reference: Label Data (p.194)
- ▶ Reference: Labeling+ (p.198)
- ▶ Reference: Defect (p.217)
- ▶ Reference: Precise Defect (p.225)
- ▶ Reference: Fine Matching (p.233)
- ▶ Reference: Character Inspection (p.244)
- ▶ Reference: Date Verification (p.252)
- ▶ Reference: Model Dictionary (p.261)
- ▶ Reference: Barcode+ (p.269)
- ▶ Reference: 2D Code+ (p.277)
- ▶ Reference: Circle Angle (p.284)

Search

Register the feature sections of the measurement object as an image pattern (model), then find the most similar part to these models from the input images to detect the position.

The correlation value showing the degree of similarity, measurement object position, and inclination can be output.

Used in the Following Case

- When identifying the shape of measurement objects (for detecting defects or foreign matter)

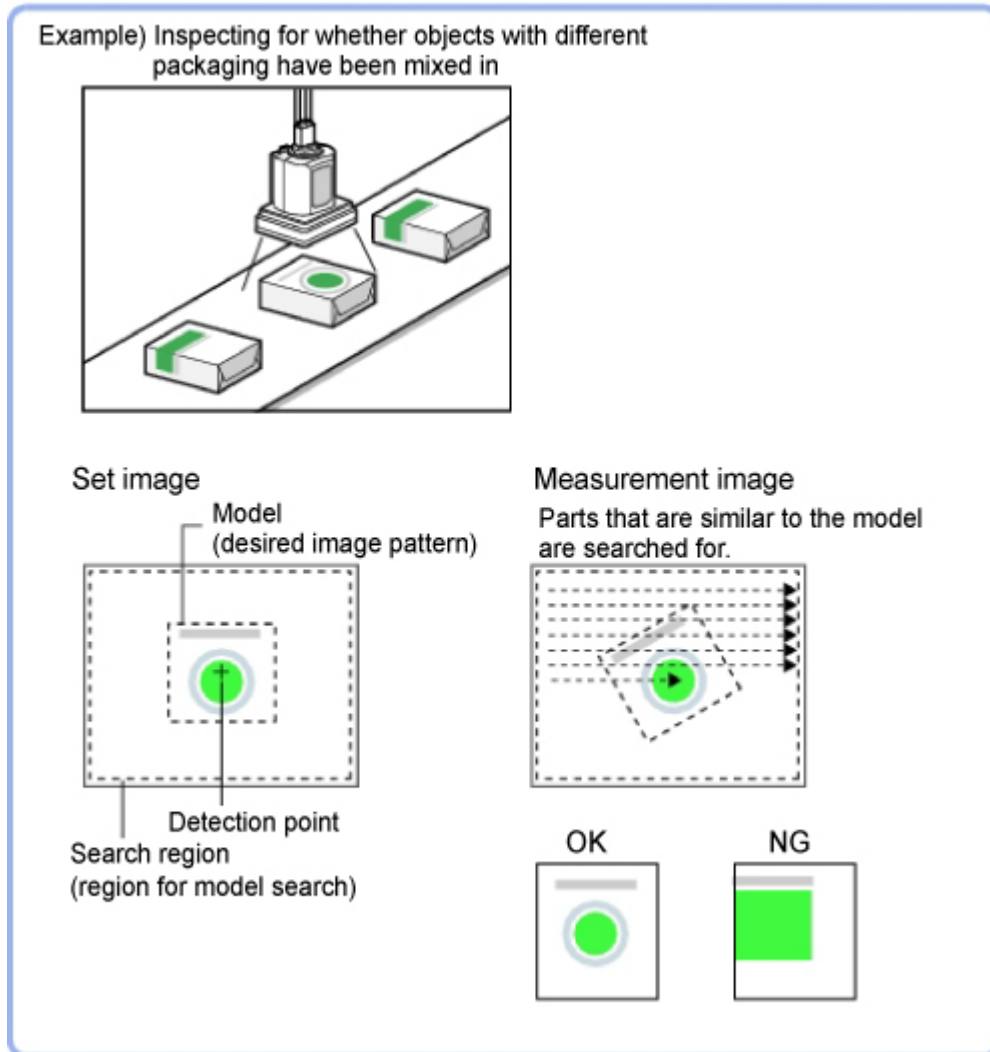

Note

- Search processing basic concepts
Reference: ▶ "User's Manual", "Search Processing Mechanism" (p.329)

Settings Flow (Search)

Set up searches according to the following flow.

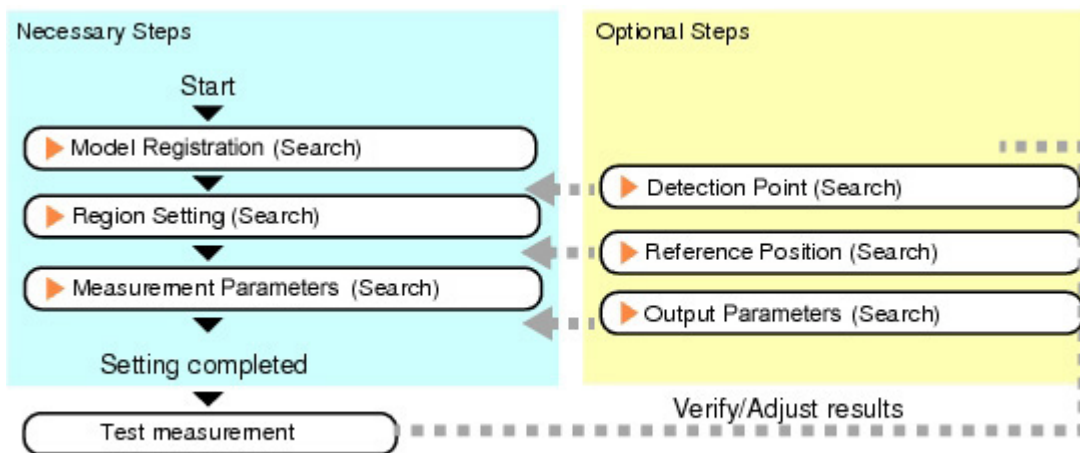

List of Search Items

Item name	Description
Model register	This item registers the pattern characteristic of the measurement image as a model. Model parameter values can be changed as needed to address unstable measurement results or to increase the processing speed. Normally, the factory default value will be used. Reference: ▶ Model Registration (Search) (p.49)
Region setting	This item is used to set up the measurement area. Instead of measuring the entire input image, narrowing the measurement area shortens the processing time. Reference: ▶ Region Setting (Search) (p.52)
Detection point	This item can be changed if necessary. Specify a position in the model that should be used as the detection coordinates during measurement. Usually, the central position of the set model is registered as the detection coordinates. Reference: ▶ Detection Point (Search) (p.53)
Ref. position	This item can be changed if necessary. Specify the reference position within the camera's field of view. Reference: ▶ Reference Position (Search) (p.53)
Measurement	This item specifies the judgement condition for measurement results. Specify the criteria to judge the measurement result if the X and Y coordinates and the correlation with the model are OK. Reference: ▶ Measurement Parameters (Search) (p.54)
Output parameter	This item can be changed if necessary. Normally, the factory default value will be used. Use the output parameter to specify how to handle the coordinates. Reference: ▶ Output Parameters (Search) (p.56)

Model Registration (Search)

Register the parts to measure as the model.

The position at the time of registration is also registered in the model information. Place the measurement object in the correct position when registering a model.

1. In the Item Tab area, tap [Model register].
When setting a new model, you do not have to tap [Model register].

- Use the drawing tools to specify the model registration range.

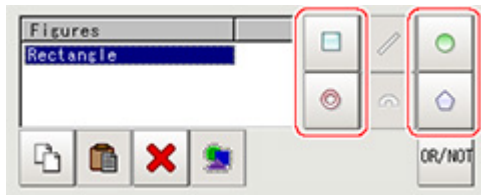

- To save the entire image used for model registration, place a check at the "Save registered model" option.



Note

- If you save the registered model image, you can re-register the model with the same image after model parameters are adjusted. Note that the scene data size increases when a registered model image is saved.

- Tap [OK].
The model is registered.

Note

- When a model is registered, the central coordinates of the model are registered as the detection point. A detection point is a point output as a measurement value. If multiple figures are combined, the central coordinates of the circumscribed rectangle are registered.

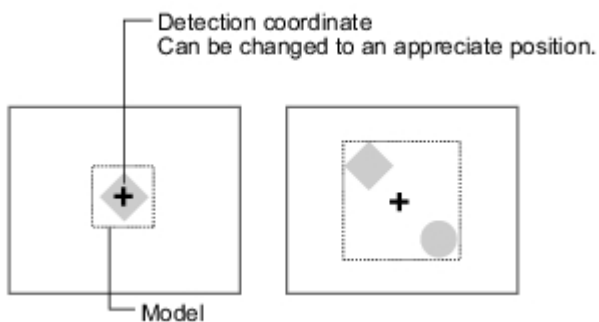

Changing Model Parameters

Model parameter values can be changed as needed to address unstable measurement results or to increase the processing speed. Normally, the factory default value will be used.

After changing a setting, re-register the model.

- In the "Model parameter" area, select the search mode, then specify a value for each item for

that mode.

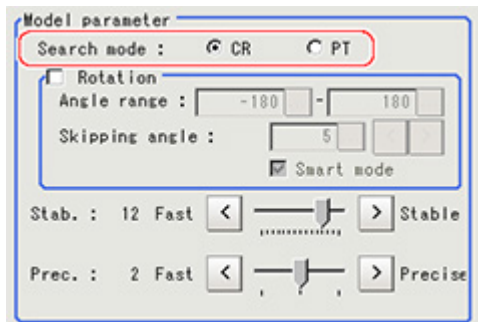

Setting item	Set value [factory default]	Description
Search mode	[CR]	Search for normalizing the brightness. This method can provide stable measurement when there is fluctuation in the overall brightness and when the image has low contrast.
	PT	Measures the degree of matching with the model profile. This method can measure at higher speed when the rotation angle has a wide range. It is available only when a 0.3 megapixel color camera is connected.

When CR is selected

Setting item	Set value [factory default]	Description
Rotation	Checked [Unchecked]	When the measurement object is rotating, place a check at "Rotation" and specify how many degrees the model created rotates each time and through what range of angles. A smaller skipping angle increases stability, but slows down the processing. The normal direction is clockwise.
	Angle range	[-180 to 180]
	Skipping angle	1 to 30 [5]
Smart mode	[Checked] Unchecked	Checking the "Smart mode" option enables a high-speed rotation search. However, the stability may be lowered when the model shape aspect ratio is large or when the NOT mask is used.
Stability	1 to 15 [The default value depend on the connected camera. 9 or 12]	Specify which is to have priority, measurement stability or speed. If lowering stability does not speed up processing, it is likely that many candidates have been detected. In this case, specify a larger value for "Candidate LV" or "Stab."
Prec.	1 to 3 [2]	Specify which is to have priority, measurement positional precision or speed.

When PT is selected

Setting item	Set value [factory default]	Description
Angle range	[-180 to 180]	This item specifies the rotation angle range for searching. The normal direction is clockwise.
Stability	1 to 5 [3]	If lowering stability does not speed up processing, it is likely that many candidates have been detected. In this case, specify a larger value for "Candidate LV" or "Stab."

Displaying/Re-Registering/Deleting a Model

If you save the model registration image, it is easy to re-register the model after model parameters are changed.

Item	Description
Disp model/Input image	The model image display and input image display are switched.
Re-register	When model parameters are modified, display the original model image and re-register the model.
Delete	Deletes models.

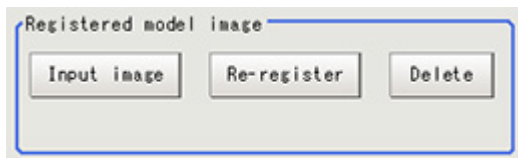

Region Setting (Search)

Use a rectangle to specify the area where the model is searched.

Instead of measuring the entire input image, narrowing the measurement area shortens the processing time.

1. In the Item Tab area, tap [Region setting].
2. Tap [Edit].

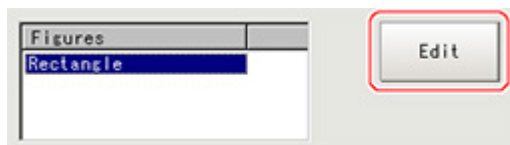

The figure setting area is displayed.

3. Specify the area in which to search for the model.
The rectangle covering the entire screen is set. Adjust the size and position of the rectangle.
4. Tap [OK].
The area to measure is registered.

Detection Point (Search)

Specify a position in the model that should be used as the detection coordinates during measurement. Usually, the central position of the set model is registered as the detection point. This function is used to change to any desired position.

Note

- After changing the detection coordinates to another position, re-registering the model will change it back to the central coordinates of the model.

1. In the Item Tab area, tap [Detection point].
In the Image Display area, the current detection point is displayed with a crosshair cursor.
2. Tap the position to be set as the detection point.

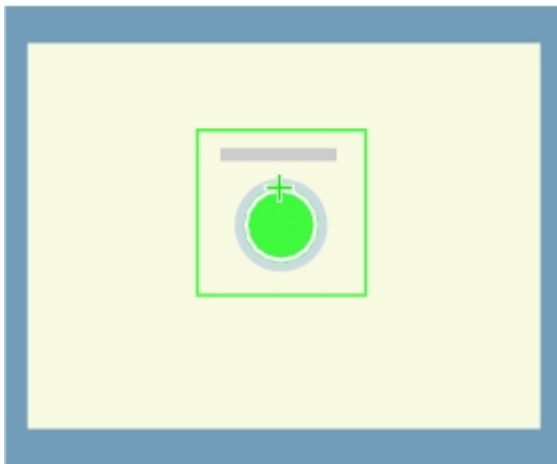

Note

- Displaying the image enlarged makes this tapping easier.
Reference: ▶ "Using the Zoom Function" in the "User's Manual" (p.347)

3. If necessary, finely adjust with numeric input and the arrow buttons.

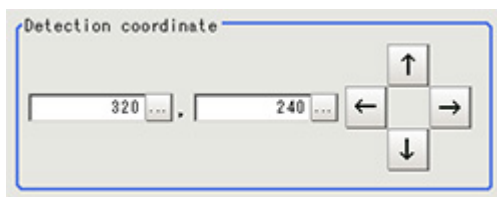

Reference Position (Search)

When the model is set, this position is automatically set at the same time as the reference position. This item can be used to change the reference position to any desired position. This is handy for measuring the positional deviation from a certain position.

1. In the Item Tab area, tap [Ref. position].
In the Image Display area, the current reference position will be displayed as the crosshair cursor.

2. Tap the position to be set as the reference position.

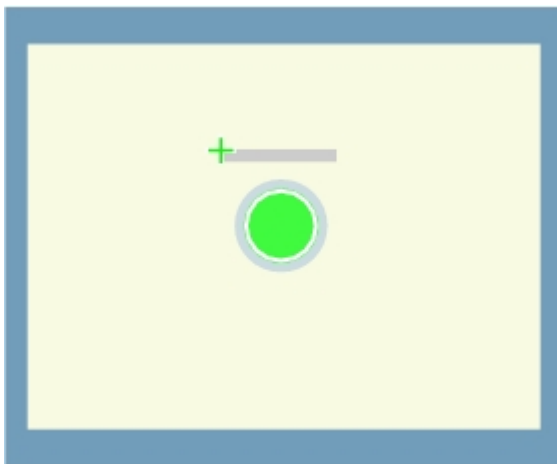

Note

- Displaying the image enlarged makes this tapping easier.
Reference: ▶ "Using the Zoom Function" in the "User's Manual" (p.347)

3. If necessary, finely adjust with numeric input and the arrow buttons.
To remeasure on the displayed image and set the reference position, tap [Measure ref.].

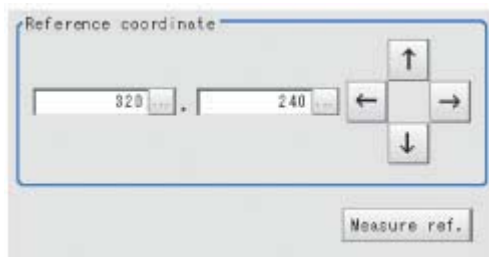

Measurement Parameters (Search)

Specify the search measurement conditions and the judgement conditions for the measurement results.

1. In the Item Tab area, tap [Measurement].
2. In the "Measurement condition" area, specify a value for each item.

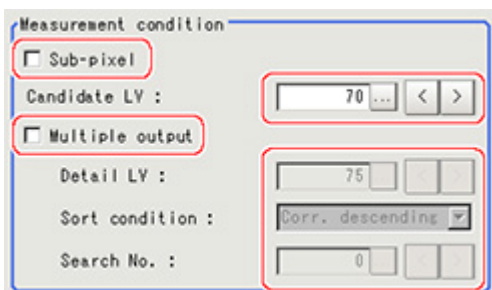

Setting item	Set value [factory default]	Description
Sub-pixel	<ul style="list-style-type: none"> · Checked · [Unchecked] 	When a check is placed at sub-pixel, the position information can be measured in units of sub-pixels. However, this requires more processing time.

Candidate LV	0 to 100 [70]	Specify the threshold value with which to detect candidate points in a rough search. Specify a smaller value when model search results are unreliable.
--------------	------------------	--

When executing a multi search

Setting item	Set value [factory default]	Description
Multiple output	<ul style="list-style-type: none"> • Checked • [Unchecked] 	Select to execute a multi search.
Detail LV	0 to 100 [75]	Specify the threshold value with which to detect candidate points in a detail search.
Sort condition	<ul style="list-style-type: none"> • Corr. ascending • [Corr. descending] • X ascending • X descending • Y ascending • Y descending 	Specify the conditions by which the search number is re-assigned. When sorting referencing the X and Y coordinates, the upper left is the origin.
Search No.	0 to 31 [0]	Input the search number for outputting the data.

- When the setting has been changed, tap [Measurement] in the Detail area to verify whether measurements can be made correctly.



- Set up the judgement condition.

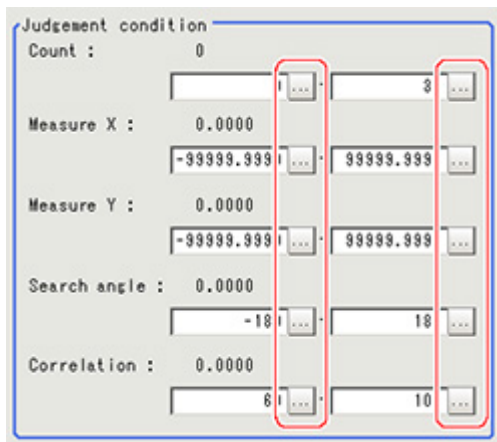

Note

- The values beside each item are measurement results of the displayed image. Take these values into consideration to determine the upper and lower limits.

Setting item	Set value	Description
Count	0 to 32	Specify the number of detections that are judged to be OK.
Measure X	-99999.9999 to 99999.9999	Specify the range of X-axis shifting that is judged to be OK.
Measure Y	-99999.9999 to 99999.9999	Specify the range of Y-axis shifting that is judged to be OK.

Measure angle	-180 to 180	Specify the range of angles that are judged to be OK.
Correlation	0 to 100	Specify the range of correlation values that are judged to be OK. However, when the correlation value of the measurement result is 0, the judgement result will be NG regardless of the lower limit setting.

Output Parameters (Search)

Specify how to treat the coordinates to be output to the external device as measurement results. This item can be changed if necessary. Normally, the factory default value will be used.

Important

- After setting up the measurement parameters, changing the output parameters will cause measurement results to vary accordingly. If the output parameters have been changed, re-specify the measurement, too.

- Tap [Output parameter] in the Item Tab area.
- Specify each of the following items.

Setting item	Set value [factory default]	Description
Output Coordinates	<ul style="list-style-type: none"> [After scroll] Before scroll 	As measurement results, select whether to output coordinate values to external devices before or after the position deflection correction is applied.
Calibration	<ul style="list-style-type: none"> [OFF] ON 	Select whether to reflect the calibration in the values output to the external device as measurement results. ON: Output the coordinates converted into actual dimensions. OFF: Output the camera coordinate values.
Reflect to overall judgement	<ul style="list-style-type: none"> [ON] OFF 	Enables choosing whether or not the judgement results of this processing unit is reflected in the scene overall judgement.

Key Points for Test Measurement and Adjustment (Search)

The following content is displayed in the "Detail result" area as text.

Important

- Executing test measurements will also update the measurement results and the figures in the image.

Displayed items	Description
Judge	Judgement result
Count	Count
Correlation	Correlation value
Position X	X coordinate of the position where the model is detected
Position Y	Y coordinate of the position where the model is detected
Angle	Angle of the position where the model is detected

Key Points for Adjustment

Select the adjustment method referring to the following points.

When the measurement results are unstable

Searching other positions

Parameter to be adjusted	Remedy
Model parameter	Specify a larger value for the "Prec."
	If the measurement results are unstable only when "Rotation" is selected, specify a smaller value for the "Skipping angle".
	When "Rotation" is selected, if the model shape is complex, uncheck the "Smart mode" option.
	If the image has low contrast or blurred edges, set the "Search mode" to "CR".
	If the model image consists of detailed figures, specify a larger value for "Stab."
Measurement	If the precision is low, place a check at "Sub-pixel".
	If images that should be judged OK vary greatly, specify a smaller value for "Candidate LV".
	If the model image is small and unstable, specify a smaller value for the "Reduction".

The judgement is NG (insufficient memory)

Parameter to be adjusted	Remedy
Region setting	Make the search region as small as possible.
Model parameter	Bring "Stab." close to the factory default value.
	Bring the "Skipping angle" close to the factory default value.
	Specify a smaller value for "Prec.".

When the processing speed is slow

Parameter to be adjusted	Remedy
Region setting	Make the search region as small as possible.
Model	Make the area to register as the model as small as possible.

Model parameter	If the model image is a simple figure or a large figure, specify a smaller value for "Stab." If lowering stability does not speed up processing, it is likely that many candidates have been detected. Raise the "Candidate LV" in [Measurement].
	When "Rotation" is selected and the model image is a simple figure, specify a larger value for "Skipping angle".
	When "Rotation" is selected and the model image is a simple figure, place a check at "Smart mode".
	If the position precision is high, specify a smaller value for "Prec.".
	If the rotation angle range is large, set the "Search mode" to "PT".
Measurement	If images that should be judged OK vary little, specify a larger value for "Candidate LV".
	If the position precision is high, uncheck "Sub-pixel".

Measurement Results for Which Output Is Possible (Search)

The following values can be output using processing items related to results output. It is also possible to reference measurement values from expressions and other processing units.

Measurement items	Character string	Description
Judgement	JG	Judgement result
Count	C	Number of search items detected If none detected, 0
Correlation value	CR	Correlation value with the model
Measurement coordinate X	X	X coordinate of the position where the model is detected
Measurement coordinate Y	Y	Y coordinate of the position where the model is detected
Measurement angle	TH	Angle of the position where the model is detected
Reference position X	SX	X coordinate of the reference position of the registered model
Reference position Y	SY	Y coordinate of the reference position of the registered model
Reference angle	ST	Angle of the registered model
Detection point RX	RX	X coordinate of the registered model
Detection point RY	RY	Y coordinate of the registered model
Correlation value N (N = 00 to 31)	CRN	Detected search N correlation value (N = 00 to 31)
Position N (N = 00 to 31)	XN	Detected search N position X (N = 00 to 31)
Position N (N = 00 to 31)	YN	Detected search N position Y (N = 00 to 31)
Angle N (N = 00 to 31)	THN	Detected search N angle TH (N = 00 to 31)

Flexible Search

In Flexible Search, multiple measurement object features (models) are registered beforehand. Parts from input images that most resemble the multiple models are searched for, and correlation (similarity) and position are determined.

Used in the Following Case

- To treat models with only slight variations as the same and prevent excessive filtering out.

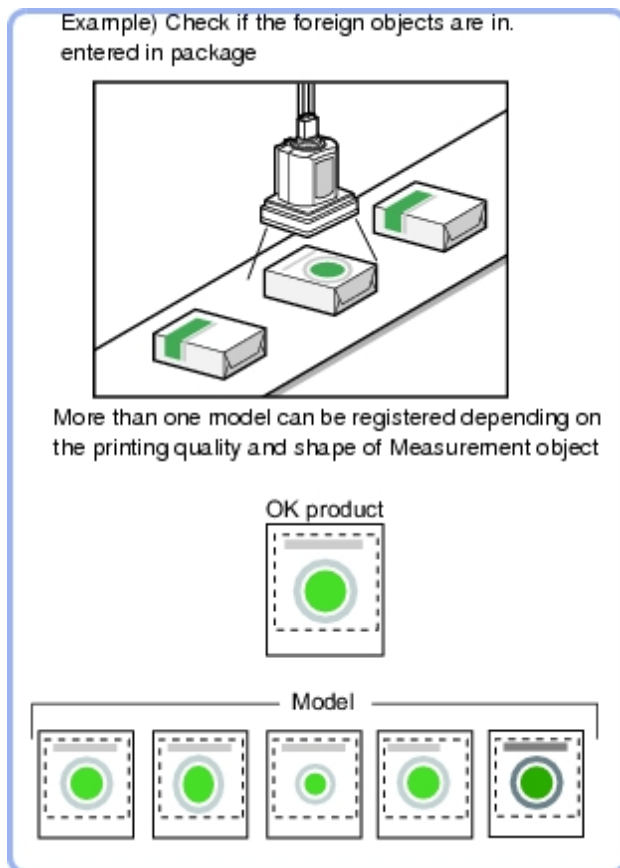

Note

- Search processing basic concepts
Reference: ▶ "User's Manual", "Search Processing Mechanism" (p.329)

Settings Flow (Flexible Search)

Set up flexible search according to the following steps.

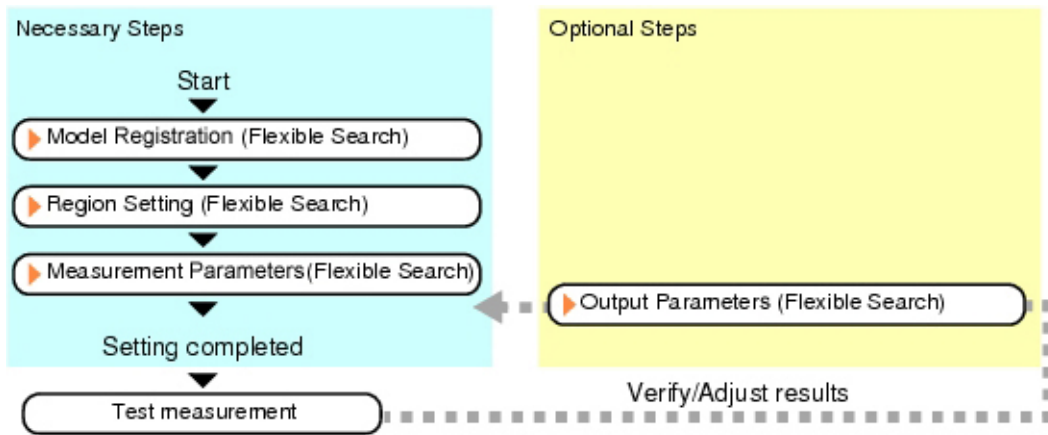

List of Flexible Search Items

Item name	Description
Model register	This item registers the pattern characteristic of the measurement image as a model. Model parameter values can be changed as needed to address unstable measurement results or to increase the processing speed. Normally, the factory default value will be used. Reference: ▶ Model Registration (Flexible Search) (p.60)
Region setting	This item is used to set up the measurement area. Instead of measuring the entire input image, narrowing the measurement area shortens the processing time. Reference: ▶ Region Setting (Flexible Search) (p.63)
Measurement	This item specifies the judgement condition for measurement results. Specify the criteria to judge the measurement result if the X and Y coordinates and the correlation with the model are OK. Reference: ▶ Measurement Parameters (Flexible Search) (p.63)
Output parameter	This item can be changed if necessary. Normally, the factory default value will be used. Use the output parameter to specify how to handle the coordinates. Reference: ▶ Output Parameters (Flexible Search) (p.65)

Model Registration (Flexible Search)

Register the parts to measure as the model.

A total of 5 models, 0 through 4, can be registered, with no restriction on the size.

If a model has different printing qualities and shapes, more than one models should be registered.

The position at the time of registration is also registered in the model information. Place the measurement object in the correct position when registering a model.

1. In the Item Tab area, tap [Model register].
2. In the "Setting model" area, select a model and tap [New].

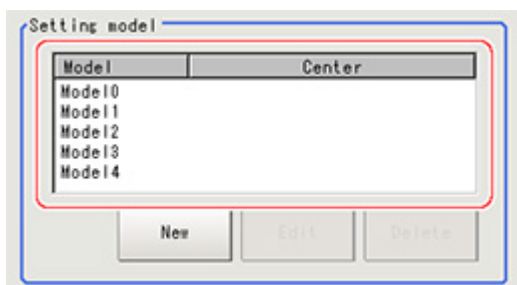

- Use the drawing tools to specify the model registration range.

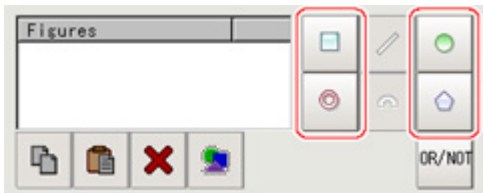

- In the figure setting area, tap [OK].
The model is registered and its center X and Y coordinate values are displayed in the "Setting model" area.

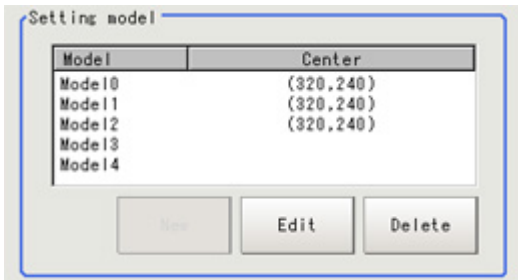

The image specified for the model is displayed in the Image Display area.

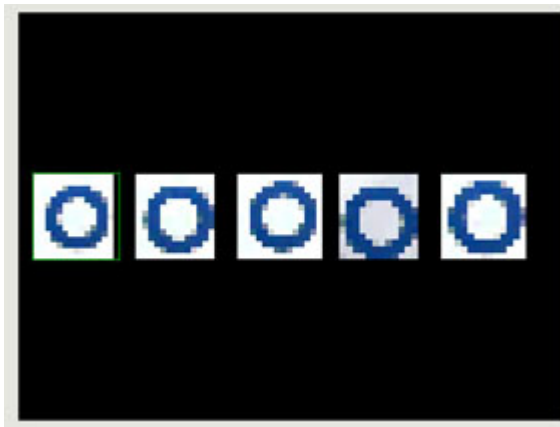

- To register two or more models, repeat the Steps Reference: ▶ 2(p.60) to Reference: ▶ 4(p.61) .

Important

- When a model is registered, the center of the model is registered as the detection point. A detection point is a point output as a measurement value. If multiple figures are combined, the central coordinates of the circumscribed rectangle are registered.

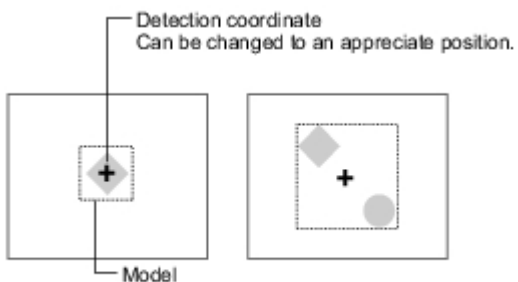

Changing Model Parameters

Model parameter values can be changed as needed to address unstable measurement results or to increase the processing speed. Normally, the factory default value will be used. After changing a setting, re-register the model.

1. In the "Model parameter" area, select the search mode, then specify a value for each item for that mode.

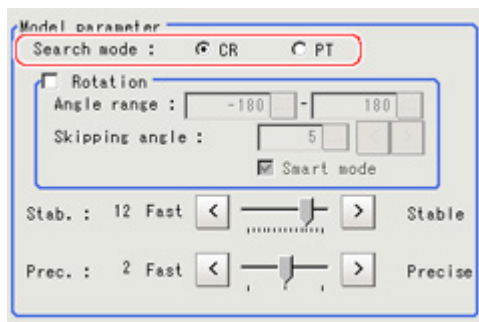

Setting item	Set value [factory default]	Description
Search mode	[CR]	Search for normalizing the brightness. This method can provide stable measurement when there is fluctuation in the overall brightness and when the image has low contrast.
	PT	Measures the degree of matching with the model profile. This method can measure at higher speed when the rotation angle has a wide range. It is available only when a 0.3 megapixel color camera is connected.

When CR is selected

Setting item	Set value [factory default]	Description
Rotation	Checked [Unchecked]	When the measurement object is rotating, place a check at "Rotation" and specify how many degrees the model created rotates each time and through what range of angles. A smaller skipping angle increases stability, but slows down the processing. The normal direction is clockwise.
Angle range	[-180 to 180]	
Skipping angle	1 to 30 [5]	
Smart mode	[Checked] Unchecked	Checking the "Smart mode" option enables a high-speed rotation search. However, the stability may be lowered when the model shape aspect ratio is large or when the NOT mask is used.

Stability	1 to 15 [The default value depend on the connected camera.9 or 12]	Specify which is to have priority, measurement stability or speed. If lowering stability does not speed up processing, it is likely that many candidates have been detected. In this case, specify a larger value for "Candidate LV" or "Stab."
Preciseness	1 to 3 [2]	Specify which is to have priority, measurement positional precision or speed.

When PT is selected

Setting item	Set value [factory default]	Description
Angle range	[-180 to 180]	This item specifies the rotation angle range for searching. The normal direction is clockwise.
Stability	1 to 5 [3]	If lowering stability does not speed up processing, it is likely that many candidates have been detected. In this case, specify a larger value for "Candidate level" or "Stab."

Region Setting (Flexible Search)

Use a rectangle to specify the area where the model is searched. Instead of measuring the entire input image, narrowing the measurement area shortens the processing time.

1. In the Item Tab area, tap [Region setting].
2. Tap [Edit].

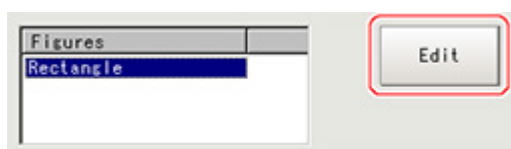

The figure setting area is displayed.

3. Specify the area in which to search for the model.
The rectangle covering the entire screen is set. Adjust the size and position of the rectangle.
4. Tap [OK].
The area to measure is registered.

Measurement Parameters (Flexible Search)

Specify the search measurement conditions and the judgement conditions for the measurement results.

1. In the Item Tab area, tap [Measurement].

2. In the "Measurement condition" area, specify a value for each item.

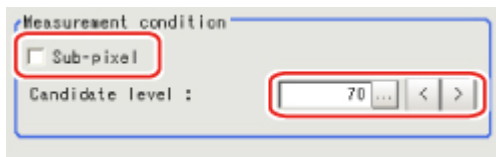

Setting item	Set value [factory default]	Description
Sub-pixel	<ul style="list-style-type: none"> · Checked · [Unchecked] 	When a check is placed at sub-pixel, the position information can be measured in units of sub-pixels. However, this requires more processing time.
Candidate level	0 to 100 [70]	Specify the threshold value with which to detect candidate points in a rough search. Specify a smaller value when model search results are unreliable.

3. When the setting has been changed, tap [Measurement] in the Detail area to verify whether measurements can be made correctly.



4. Set up the judgement condition.

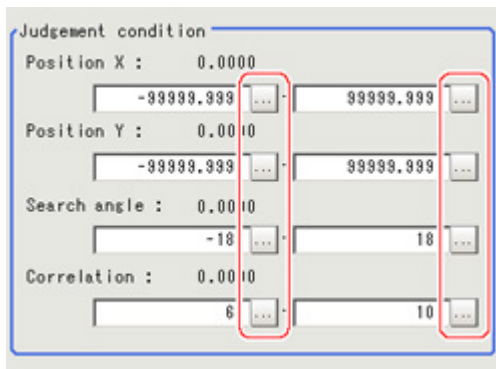

Note

- The values beside each item are measurement results of the displayed image. Take these values into consideration to determine the upper and lower limits.

Setting item	Set value	Description
Position X	-99999.9999 to 99999.9999	Specify the range of X-axis shifting that is judged to be OK.
Position Y	-99999.9999 to 99999.9999	Specify the range of Y-axis shifting that is judged to be OK.
Search angle	-180 to 180	Specify the range of angles that are judged to be OK.
Correlation	0 to 100	Specify the range of correlation values that are judged to be OK. However, when the correlation value of the measurement result is 0, the judgement result will be NG regardless of the lower limit setting.

Output Parameters (Flexible Search)

Specify how to treat the coordinates to be output to the external device as measurement results. This item can be changed if necessary. Normally, the factory default value will be used.

Important

- After setting up the measurement parameters, changing the output parameters will cause measurement results to vary accordingly. If the output parameters have been changed, re-specify the measurement, too.

- Tap [Output parameter] in the Item Tab area.
- Specify each of the following items.

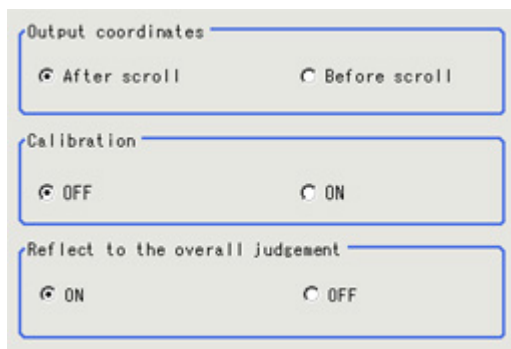

Setting item	Set value [factory default]	Description
Output Coordinates	<ul style="list-style-type: none"> [After scroll] Before scroll 	As measurement results, select whether to output coordinate values to external devices before or after the position deflection correction is applied.
Calibration	<ul style="list-style-type: none"> [OFF] ON 	Select whether to reflect the calibration in the values output to the external device as measurement results. ON: Output the coordinates converted into actual dimensions. OFF: Output the camera coordinate values.
Reflect to overall judgement	<ul style="list-style-type: none"> [ON] OFF 	Enables choosing whether or not the judgement results of this processing unit is reflected in the scene overall judgement.

Key Points for Test Measurement and Adjustment (Flexible Search)

The following content is displayed in the "Detail result" area as text.

Displayed items	Description
Judge	Judgement result
Model number	Model No. of the biggest correlation
Correlation	Correlation value
Position X	X coordinate of the position where the model is detected
Position Y	Y coordinate of the position where the model is detected
Angle	Angle of the position where the model is detected

Note

- If the model is an ellipse, its circumscribing rectangle is displayed as the search result of the model.

Key Points for Adjustment

Select the adjustment method referring to the following points.

When the measurement results are unstable

Searching other positions

Parameter to be adjusted	Remedy
Model parameter	Specify a larger value for the "Prec."
	If the measurement results are unstable only when "Rotation" is selected, specify a smaller value for the "Skipping angle".
	When "Rotation" is selected, if the model shape is complex, uncheck the "Smart mode" option.
	If the image has low contrast or blurred edges, set the "Search mode" to "CR".
	If the model image consists of detailed figures, specify a larger value for "Stab."
Measurement	If the precision is low, place a check at "Sub-pixel".
	If images that should be judged OK vary greatly, specify a smaller value for "Candidate level".
	If the model image is small and unstable, specify a smaller value for the "Reduction".

The judgement is NG (insufficient memory)

Parameter to be adjusted	Remedy
Region setting	Make the search region as small as possible.
Model parameter	Bring "Stab." close to the factory default value.
	Bring the "Skipping angle" close to the factory default value.
	Specify a smaller value for "Prec."

When the processing speed is slow

Parameter to be adjusted	Remedy
Region setting	Make the search region as small as possible.
Model	Make the area to register as the model as small as possible.
Model parameter	If the model image is a simple figure or a large figure, specify a smaller value for "Stab." If lowering stability does not speed up processing, it is likely that many candidates have been detected. Raise the "Candidate level" in [Measurement].
	When "Rotation" is selected and the model image is a simple figure, specify a larger value for "Skipping angle".
	When "Rotation" is selected and the model image is a simple figure, place a check at "Smart mode".
	If the position precision is high, specify a smaller value for "Prec."
	If the rotation angle range is large, set the "Search mode" to "PT".
Measurement	If images that should be judged OK vary little, specify a larger value for "Candidate level".
	If the position precision is high, uncheck "Sub-pixel".

Measurement Results for Which Output Is Possible (Flexible Search)

The following values can be output using processing items related to results output. It is also possible to reference measurement values from expressions and other processing units.

Measurement items	Character string	Description
Judgement	JG	Judgement result
Model No.	NO	Model No. of the biggest correlation
Correlation value	CR	Correlation with the model
Measurement coordinate X	X	X coordinate of the position where the model is detected
Measurement coordinate Y	Y	Y coordinate of the position where the model is detected
Measurement angle	TH	Angle of the position where the model is detected
Reference position X	SX	X coordinate of the reference position of the registered model
Reference position Y	SY	Y coordinate of the reference position of the registered model
Reference angle	ST	Angle of the registered model
Detection point RX	RX	X coordinate of the registered model
Detection point RY	RY	Y coordinate of the registered model

Sensitive Search

The registered models are automatically finely divided and matched in detail. Of the divided models, the one with the lowest correlation is output. Sensitive search is suitable when the difference between the model image and measurement image is small and regular searches do not produce differences in correlation.

Used in the Following Case

- When identifying the shape of the divided area

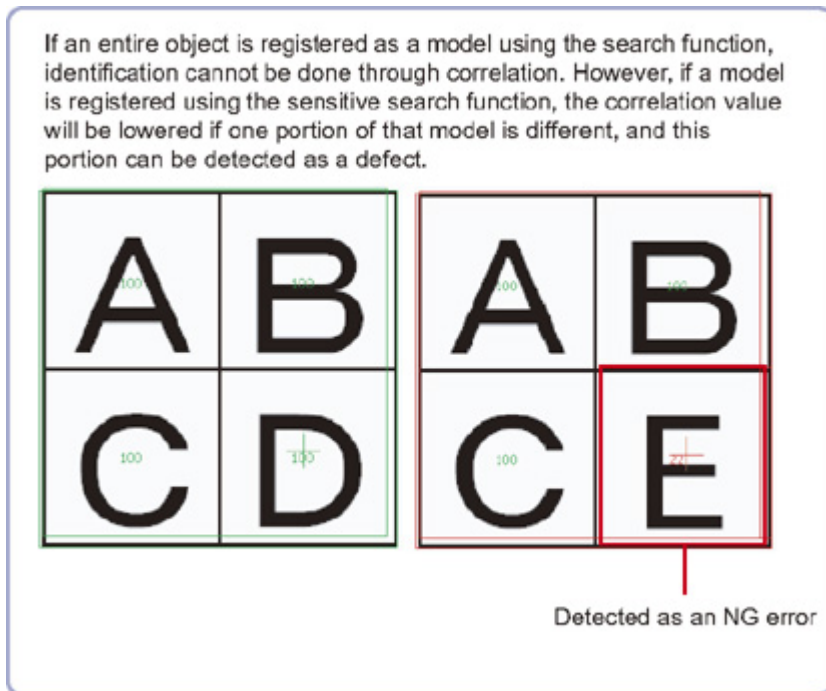

Settings Flow (Sensitive Search)

Set up sensitive search according to the following steps.

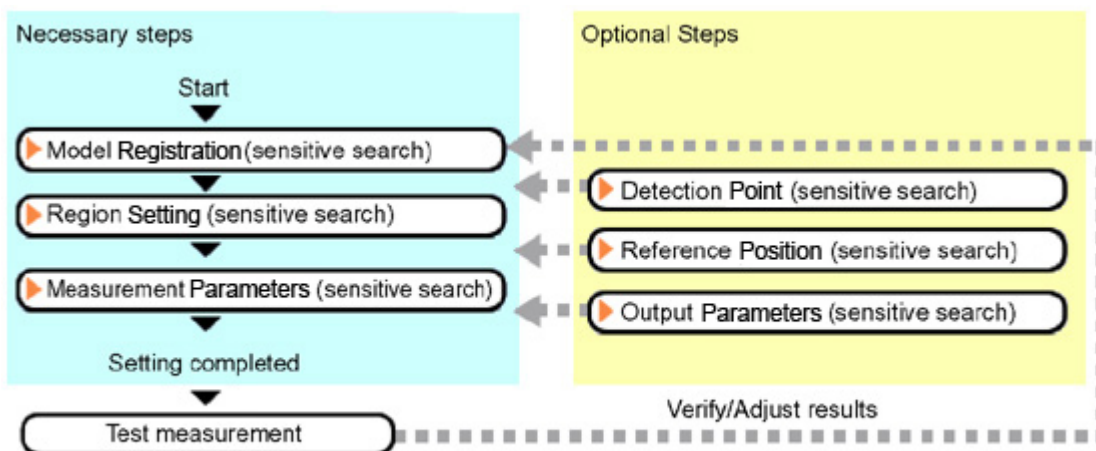

List of Sensitive Search Items

Item name	Description
Model register	This item registers the pattern characteristic of the measurement image as a model. Model parameter values can be changed as needed to address unstable measurement results or to increase the processing speed. Normally, the factory default value will be used. Reference: ▶ Model Registration (Sensitive Search) (p.69)
Region setting	This item is used to set up the measurement area. Instead of measuring the entire input image, narrowing the measurement area shortens the processing time. Reference: ▶ Region Setting (Sensitive Search) (p.72)
Detection point	This item can be changed if necessary. Specify a position in the model that should be used as the detection coordinates during measurement. Usually, the central position of the set model is registered as the detection coordinates. Reference: ▶ Detection Point (Sensitive Search) (p.73)
Ref. position	This item can be changed if necessary. Specify the reference position within the camera's field of view. Reference: ▶ Reference Position (Sensitive Search) (p.73)
Measurement	This item specifies the judgement condition for measurement results. Specify the criteria to judge the measurement result if the X and Y coordinates and the correlation with the model are OK. Reference: ▶ Measurement Parameters (Sensitive Search) (p.74)
Output parameter	This item can be changed if necessary. Normally, the factory default value will be used. Use the output parameter to specify how to handle the coordinates. Reference: ▶ Output Parameters (Sensitive Search) (p.75)

Model Registration (Sensitive Search)

Register the parts to measure as the model.

The position at the time of registration is also registered in the model information. Place the measurement object in the correct position when registering a model.

1. In the Item Tab area, tap [Model register].
When setting a new model, you do not have to tap [Model register].
2. Use the drawing tools to specify the model registration range.

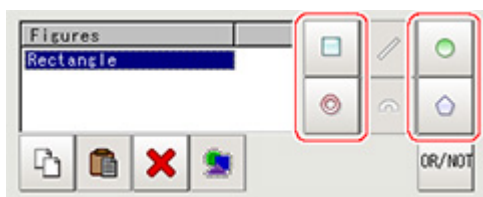

3. To save the entire image used for model registration, place a check at the "Save registered model" option. Also, when registering a model but not holding the disable setting for the sub-region set during the last time the model was registered, uncheck the "Keep disabled setting" option.

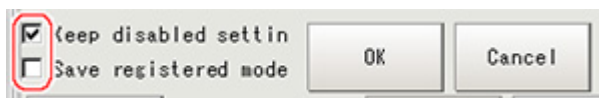

Setting item	Set value [factory default]	Description
Keep disabled setting	<ul style="list-style-type: none"> • [Checked] • Unchecked 	When the model is registered, this holds the disable setting for the sub-region set during the last time the model was registered.
Save registered model.	<ul style="list-style-type: none"> • Checked • [Unchecked] 	To save the entire image used for model registration, place a check at this option.

4. Tap [OK].
The model is registered.

Changing Model Parameters

Model parameter values can be changed as needed to address unstable measurement results or to increase the processing speed. Normally, the factory default value will be used. After changing a setting, re-register the model.

1. In the "Model parameter" area, set each item.

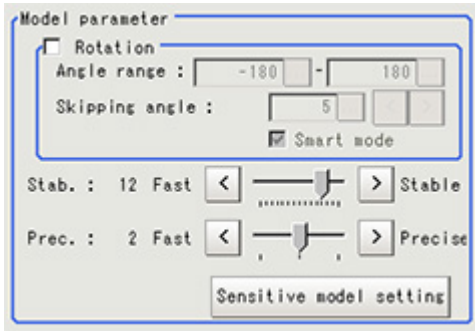

Setting item	Set value [factory default]	Description
Rotation	<ul style="list-style-type: none"> • Checked • [Unchecked] 	When the measurement object is rotating, place a check at "Rotation" and specify how many degrees the model created rotates each time and through what range of angles. A smaller skipping angle increases stability, but slows down the processing. The normal direction is clockwise.
Angle range	[-180 to 180]	
Skipping angle	1 to 30 [5]	
Smart mode	<ul style="list-style-type: none"> • [Checked] • Unchecked 	Checking the "Smart mode" option enables a high-speed rotation search. However, the stability may be lowered when the model shape aspect ratio is large or when the NOT mask is used.
Stability	1 to 15 [The default value depend on the connected camera. 9 or 12]	Specify which is to have priority, measurement stability or speed. If lowering stability does not speed up processing, it is likely that many candidates have been detected. In this case, specify a larger value for "Candidate level" or "Stab."
Preciseness	1 to 3 [2]	Specify which is to have priority, measurement positional precision or speed.

Changing Sub-model parameter

Set the "Sensitive model setting" as necessary.

1. Tap [Sensitive model setting] in the model parameter.

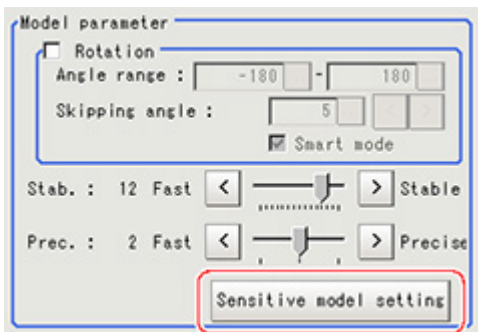

2. Set up the sub-model parameter.

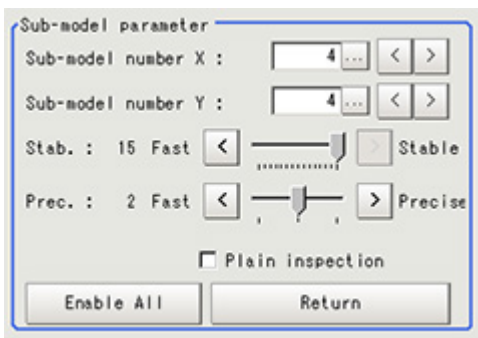

Setting item	Set value [factory default]	Description
Sub-model number X	0 to 10 [4]	This sets the number of divisions of the registered model in the X direction.
Sub-model number Y	0 to 10 [4]	This sets the number of divisions of the registered model in the Y direction.
Stability	1 to 15 [The default value depend on the connected camera. 12 or 15]	Specify which is to have priority, measurement stability or speed. If lowering stability does not speed up processing, it is likely that many candidates have been detected. In this case, specify a larger value for "Candidate level" or "Stab."
Preciseness	1 to 3 [2]	Specify which is to have priority, measurement positional precision or speed.
Plain inspection	<ul style="list-style-type: none"> • Checked • [Unchecked] 	Specify whether or not to inspect the plain region.

Disabled setting

You can specify enable/disable of each sub-region.

1. Tap the region you wish to disable and select "Disabled".

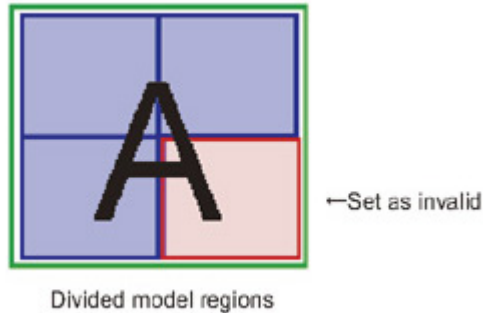

To release the disabling of a region, tap "Enable All".

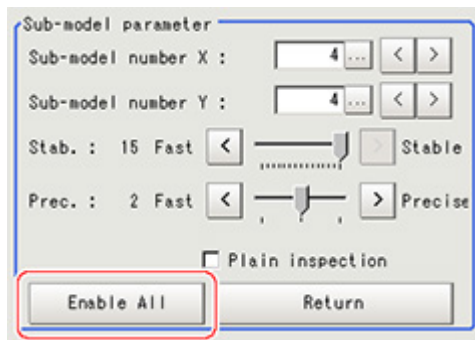

Region Setting (Sensitive Search)

Use a rectangle to specify the area where the model is searched.

Instead of measuring the entire input image, narrowing the measurement area shortens the processing time.

1. In the Item Tab area, tap [Region setting].
2. Tap [Edit].

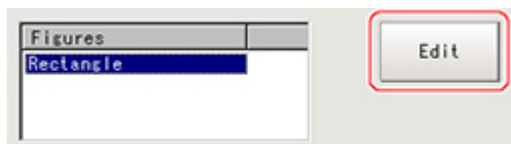

The figure setting area is displayed.

3. Specify the area in which to search for the model.
The rectangle covering the entire screen is set. Adjust the size and position of the rectangle.
4. Tap [OK].
The area to measure is registered.

Detection Point (Sensitive Search)

Specify a position in the model that should be used as the detection coordinates during measurement. Usually, the central position of the set model is registered as the detection point. This function is used to change to any desired position.

Note

- After changing the detection coordinates to another position, re-registering the model will change it back to the central coordinates of the model.

1. In the Item Tab area, tap [Detection point].
In the Image Display area, the current detection point is displayed with a crosshair cursor.
2. Tap the position to be set as the detection point.

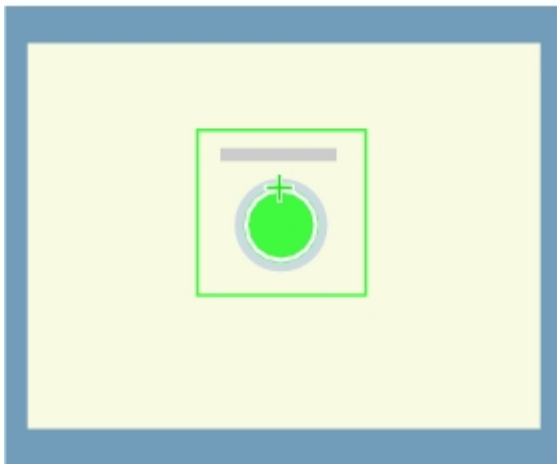

Note

- Displaying the image enlarged makes this tapping easier.
Reference: ▶ "Using the Zoom Function" in the "User's Manual" (p.347)

3. If necessary, finely adjust with numeric input and the arrow buttons.

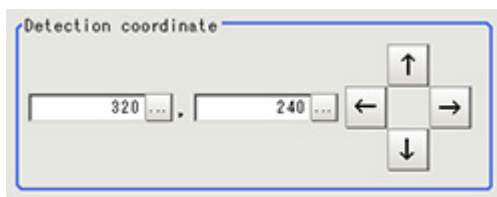

Reference Position (Sensitive Search)

When the model is set, this position is automatically set at the same time as the reference position. This item can be used to change the reference position to any desired position. This is handy for measuring the positional deviation from a certain position.

1. In the Item Tab area, tap [Ref. position].
In the Image Display area, the current reference position will be displayed as the crosshair cursor.

2. Tap the position to be set as the reference position.

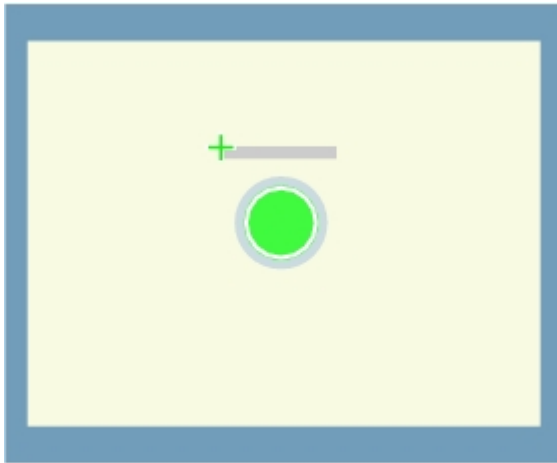

Note

- Displaying the image enlarged makes this tapping easier.
Reference: ▶ "Using the Zoom Function" in the "User's Manual" (p.347)

3. If necessary, finely adjust with numeric input and the arrow buttons.
To remeasure on the displayed image and set the reference position, tap [Measure ref.].

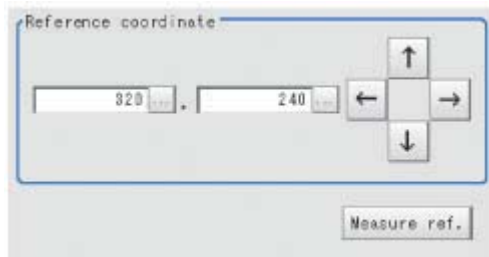

Measurement Parameters (Sensitive Search)

Specify the sensitive search measurement conditions and the judgement conditions for the measurement results.

1. In the Item Tab area, tap [Measurement].
2. In the "Measurement condition" area, specify a value for each item.

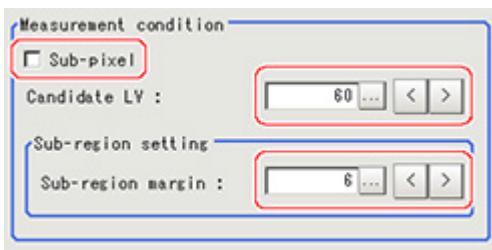

Setting item	Set value [factory default]	Description
Sub-pixel	<ul style="list-style-type: none"> · Checked · [Unchecked] 	When a check is placed at sub-pixel, the position information can be measured in units of sub-pixels. However, this requires more processing time.

Candidate level	0 to 100 [60]	Specify the threshold value with which to detect candidate points in a rough search. Specify a smaller value when model search results are unstable.
Sub-region margin	0 to 10 [6]	How large a region to use for the divided model search range for the divided model size is specified in units of pixels. If 6 is set, an area that is the model size expanded by 6 pixels up, down, left, and right is the search range.

- When the setting has been changed, tap [Measurement] in the Detail area to verify whether measurements can be made correctly.



- Set up the judgement condition.

Setting item	Set value	Description
Measure X	-99999.9999 to 99999.9999	Specify the range of X-axis shifting that is judged to be OK.
Measure Y	-99999.9999 to 99999.9999	Specify the range of Y-axis shifting that is judged to be OK.
Search angle	-180 to 180	Specify the range of angles that are judged to be OK.
Correlation	0 to 100	Specify the range of correlation values that are judged to be OK. However, when the correlation value of the measurement result is 0, the judgement result will be NG regardless of the lower limit setting.
Deviation	0 to 221	Specify the range of density deviations that are judged to be OK. The higher the proportion of plain sections, the higher this value. This is enabled when plain inspection is set in the sensitive model settings.
NG Sub-region	0 to 100	Specify the range of NG sub-region that are judged to be OK.

Output Parameters (Sensitive Search)

Specify how to treat the coordinates to be output to the external device as measurement results. This item can be changed if necessary. Normally, the factory default value will be used.

- Tap [Output parameter] in the Item Tab area.

2. Specify each of the following items.

Setting item	Set value [factory default]	Description	
Output coordinates	<ul style="list-style-type: none"> [After scroll] Before scroll 	As measurement results, select whether to output coordinate values to external devices before or after the position deflection correction is applied.	
Calibration	<ul style="list-style-type: none"> [OFF] ON 	Select whether to reflect the calibration in the values output to the external device as measurement results. ON: Output the coordinates converted into actual dimensions. OFF: Output the camera coordinate values.	
Reflect to overall judgement	<ul style="list-style-type: none"> [ON] OFF 	Enables choosing whether or not the judgement results of this processing unit is reflected in the scene overall judgement.	
Display cursor setting			
	Position	<ul style="list-style-type: none"> [ON] OFF 	The measurement coordinate position of the detected model is displayed at the cursor.
	Sub-region	<ul style="list-style-type: none"> ON [OFF] 	The coordinate position of the region with the lowest correlation value of the sub-regions is displayed at the cursor.

Key Points for Test Measurement and Adjustment (Sensitive Search)

The following content is displayed in the "Detail result" area as text.

Note

- Executing test measurements will also update the measurement results and the figures in the image.

Displayed items	Description
Judge	Judgement result
Correlation	Lowest correlation value in the sub-region
Position X	X coordinate of the position where the model is detected
Position Y	Y coordinate of the position where the model is detected

Angle	Angle of the position where the model is detected
Deviation	Highest density deviation in the sub-region
NG Sub-region	NG region count

Key Points for Adjustment

Select the adjustment method referring to the following points.

When the measurement results are unstable

Searching other positions

Parameter to be adjusted	Remedy
Model parameter	Specify a larger value for the "Prec."
	If the measurement results are unstable only when "Rotation" is selected, specify a smaller value for the "Skipping angle".
	When "Rotation" is selected, if the model shape is complex, uncheck the "Smart mode" option.
	If the model image consists of detailed figures, specify a larger value for "Stab."
Sub-model parameter	If images that should be judged OK vary greatly, specify a larger value for "Sub-model number X" and "Sub-model number Y".
Measurement	If the precision is low, place a check at "Sub-pixel".
	If images that should be judged OK vary greatly, specify a smaller value for "Candidate level".
	If images that should be judged OK vary greatly, specify a larger value for "Sub-region margin".

The judgement is NG (insufficient memory)

Parameter to be adjusted	Remedy
Region setting	Make the search region as small as possible.
Model parameter	Bring "Stab." close to the factory default value.
	Bring the "Skipping angle" close to the factory default value.
	Specify a smaller value for "Prec."
Sub-model parameter	Specify a larger value for "Sub-model number X" and "Sub-model number Y".

When the processing speed is slow

Parameter to be adjusted	Remedy
Region setting	Make the search region as small as possible.
Model Registration	Make the area to register as the model as small as possible.

Model parameter	If the model image is a simple figure or a large figure, specify a smaller value for "Stab."If lowering stability does not speed up processing, it is likely that many candidates have been detected. Raise the "Candidate level" in [Measurement].
	When "Rotation" is selected and the model image is a simple figure, specify a larger value for "Skipping angle".
	When "Rotation" is selected and the model image is a simple figure, place a check at "Smart mode".
	If the position precision is high, specify a smaller value for "Prec.".
Sub-model parameter	If images that should be judged OK vary greatly, specify a larger value for "Sub-model number X" and "Sub-model number Y".
Measurement parameter	If images that should be judged OK vary little, specify a larger value for "Candidate level".
	If the position precision is high, uncheck "Sub-pixel".

Measurement Results for Which Output Is Possible (Sensitive Search)

The following values can be output using processing items related to results output. It is also possible to reference measurement values from expressions and other processing units.

Measurement items	Character string	Description
Judgement	JG	Judgement result
Correlation value	CR	Correlation with the model
Deviation	DV	Deviation
Measurement coordinate X	X	X coordinate of the position where the model is detected
Measurement coordinate Y	Y	Y coordinate of the position where the model is detected
Measurement angle	TH	Angle of the position where the model is detected
Reference position X	SX	X coordinate of the reference position of the registered model
Reference position Y	SY	Y coordinate of the reference position of the registered model
Reference angle	ST	Angle of the registered model
Detection point X	RX	X coordinate of the registered model
Detection point Y	RY	Y coordinate of the registered model
NG Sub-region	CT	NG region count
Sub-region Number	AN	Region number with the lowest correlation value
Sub-region Number(X)	ANX	X direction column number for the output region
Sub-region Number(Y)	ANY	Y direction line number for the output region
Sub-region Pos. X	DX	X coordinate of the detected sub-region
Sub-region Pos. Y	DY	Y coordinate of the detected sub-region
Correlation (sub-region N) (N = 0 to 99)	CRN	Correlation (sub-region N)
Deviation (sub-region N) (N = 0 to 99)	DVN	Deviation (sub-region N)

ECM Search

This processing item searches the input image for parts having a high degree of similarity to the target mark (model), and measures its correlation value (similarity) and position. In a normal search, image pattern models are used that look at the color and light/dark information, but in an ECM search, models are used that look at the profile information. Therefore, this processing assures a reliable search even for low-contrast or noisy images.

Used in the Following Case

- To measure the location of a mark

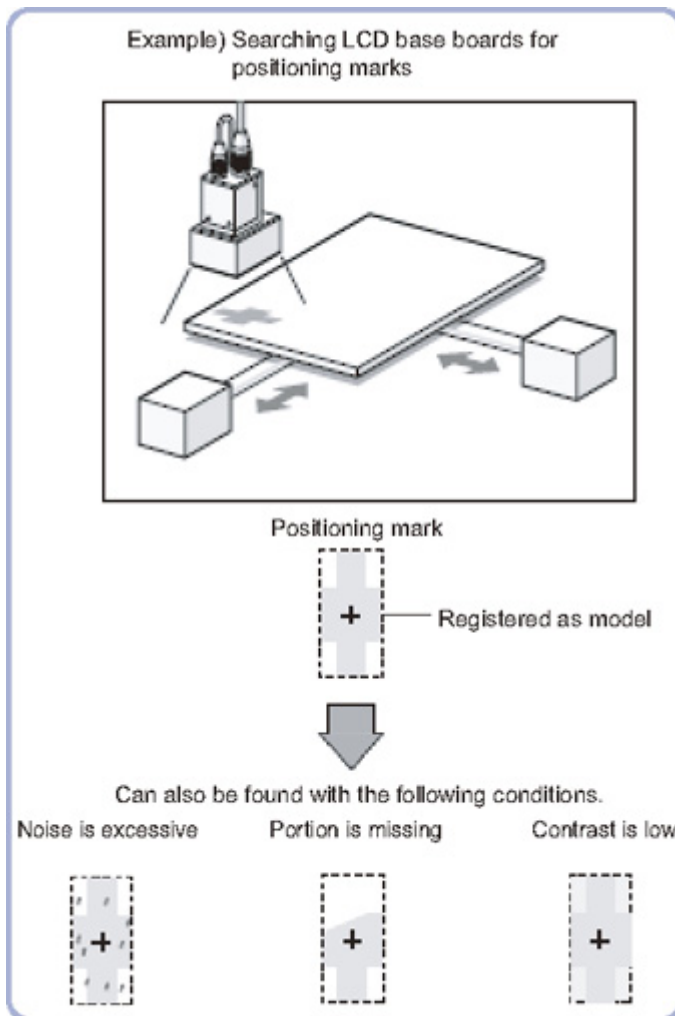

Settings Flow (ECM Search)

Set up ECM search according to the following steps.

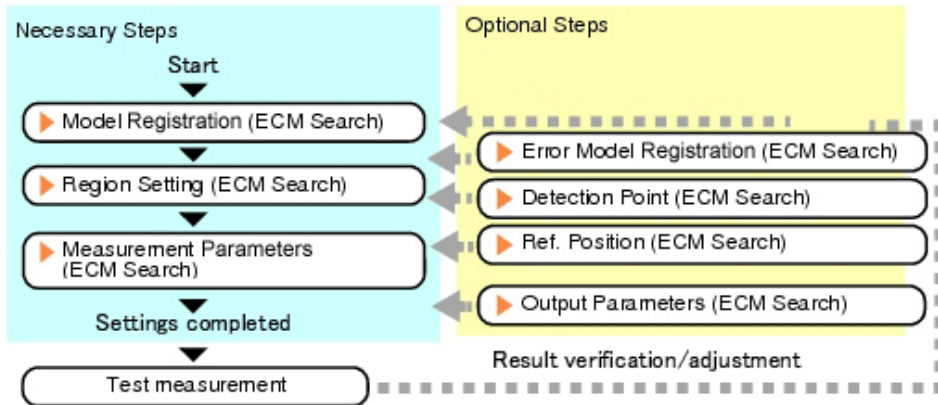

List of ECM Search Items

Item name	Description
Model register	This item registers the pattern characteristic of the measurement image as a model. Model parameter values can be changed as needed to address unstable measurement results or to increase the processing speed. Normally, the factory default value will be used. Reference: ▶ Model Registration (ECM Search) (p.80)
Error model	This item can be changed if necessary. As an error model, register a model with similar characteristics to the registered one, but with its correlation value lowered when measured. Reference: ▶ Error Model Registration (ECM Search) (p.84)
Region setting	This item is used to set up the measurement area. Instead of measuring the entire input image, narrowing the measurement area shortens the processing time. Reference: ▶ Region Setting (ECM Search) (p.84)
Detection point	This item can be changed if necessary. Usually, the central position of the registered model is registered as the search detection point. Reference: ▶ Detection Point (ECM Search) (p.84)
Ref. position	This item can be changed if necessary. Usually, the central position of the registered region is registered as the reference position. Reference: ▶ Reference Position (ECM Search) (p.85)
Measurement	This item specifies the judgement condition for measurement results. Specify the criteria to judge the measurement result if the X and Y coordinates and the correlation with the model are OK. Reference: ▶ Measurement Parameters (ECM Search) (p.86)
Output parameter	This item can be changed if necessary. Normally, the factory default value will be used. Use the output parameter to specify how to handle the coordinates. Reference: ▶ Output Parameters (ECM Search) (p.87)

Model Registration (ECM Search)

Register the pattern characteristic of the measurement object as a model. In an ECM search, only the image profile information is registered.

Important

- For ECM search, 6 pixels at each end of an image cannot be registered as a part of the model.
- Upon re-registering a model, error models are deleted. Register error models when re-registering a model.

1. In the item tab area, tap [Model register].

- When setting a new model, you do not have to tap [Model register].
- Use the drawing tools to specify the model registration range.



- In the figure setting area, tap [OK].
The model is registered.
- Tap [Edge extraction], then confirm the edge extraction image.
If there is a break in the profile of the measurement object, adjust the edge level.
Reference: ▶ Adjusting the edge level (p.83)
- If there is unnecessary profile information in the model, tap [Mask register] to set the mask.
Reference: ▶ Mask any unnecessary items. (p.82)
- To check the model display, tap [Display model].
The registered model image is displayed in the image display area.

Note

- When a model is registered, the center of the model is registered as the detection point coordinate. A detection point is a point output as a measurement value.

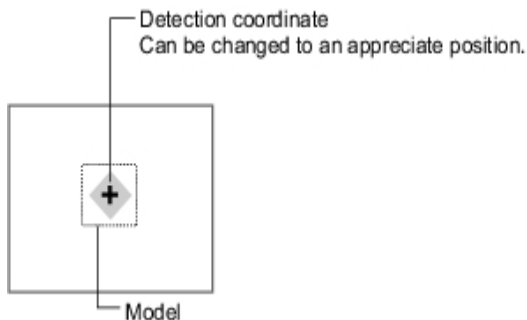

Changing Model Parameters

Model parameter values can be changed as needed to address unstable measurement results or to increase the processing speed. Normally, the factory default value will be used.

After changing a setting, check whether measurement can be done properly by performing an actual measurement.

- In the "Model parameter" area, specify a value for each item.

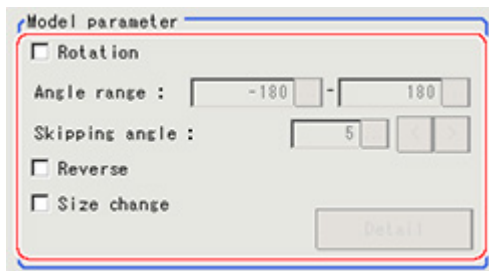

Setting item	Setting value [Factory default]	Description
Rotation	<ul style="list-style-type: none"> • Checked • [Unchecked] 	When the measurement object is rotating, select the "Rotation" check box and specify how many degrees the model created rotates each time and through what range of angles. A smaller skipping angle increases stability, but slows down the processing. The normal direction is clockwise.
Angle range	Upper limit value	-180 to [180]
	Lower limit value	[-180] to 180
Skipping angle	1 to 30 [5]	Specify how many degrees the model created rotates each time. A smaller angle increases stability, but slows down the processing.
Reverse	<ul style="list-style-type: none"> • Checked • [Unchecked] 	Specify whether to allow the reverse of light and dark for the model.
Size change	<ul style="list-style-type: none"> • Checked • [Unchecked] 	Specify whether to allow size change for the model. When checked, tap [Detail setting] and specify a value for each item.

- When the "Size change" option is checked, tap [Detail setting].
The "Model parameter: Size change" area is displayed.

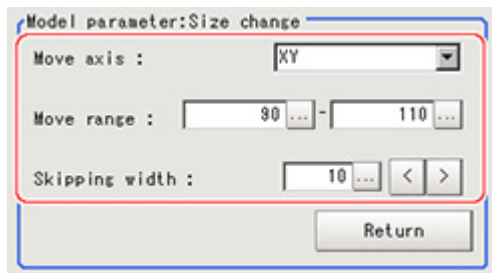

Setting item	Setting value [Factory default]	Description
Move axis	<ul style="list-style-type: none"> • [XY] • X • Y 	Specify the model variable direction.
Move range	50 to 150 [90,110]	Specify the range in which to change the model size.
Skipping width	1 to 99 [10]	Specify the skipping percentage within the move range by which to change models being created. A smaller skipping width increases precision, but slows down the processing.

- Tap [Return].
The "Model parameter" area is displayed.

Mask any Unnecessary Items.

By registering a mask, the part you do not want included in the model is excluded.

1. Tap [Mask register].

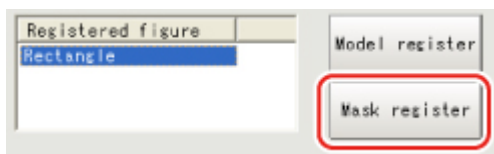

2. Draw the mask figure using the drawing tools.

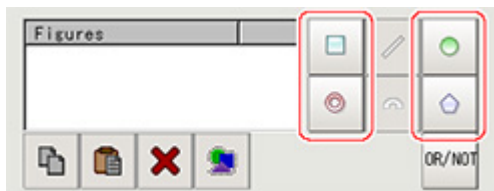

3. Tap [OR/NOT].
The mask figure is displayed in red.
4. In the figure setting area, tap [OK].

Adjusting the Edge Level

In an ECM search, processing is executed on the edge extraction image. Change this item as necessary when the edge is not extracted or is extracted along with noise.

Important

- In model registration, extract as much of the edge as possible, then delete noise etc. in the mask registration to register the entire edge of the model. On the other hand, when measuring, even if the edge has skips, an image with the noise suppressed makes it possible to search the model stably. To set separate edge extraction conditions for model registration and for measuring, after registering the model, change the edge extraction conditions.

1. In the item tab area, tap [Edge extraction].
2. Set the items in the "Edge extraction setting" area.

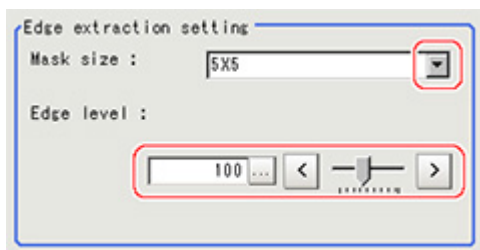

Setting item	Setting value [Factory default]	Description
Mask size	<ul style="list-style-type: none"> • 3x3 • [5 x 5] • 7x7 • 9x9 	Select the range of pixels which are used to extract the edge. With a larger mask size, search is less affected by variation in pixels.
Edge Level	0 to 255 [100]	Adjust the edge extraction level when the edge is hard to see due to low contrast with the background or when unnecessary background noise should be removed.

Error Model Registration (ECM Search)

Even for an image pattern with similar feature sections (for example "P" and "R"), if the model is registered as an error model, the correlation value is lower and measurement mistakes can be prevented. Only one error model can be registered.

1. In the Item Tab area, tap [Error model].
2. This displays the error model image.
Register the error model with the same procedure as for model registration.

Important

- Upon re-registering a model, error models are deleted. Register error models when re-registering a model.

Region Setting (ECM Search)

Use a rectangle to specify the area where the model is searched. Instead of measuring the entire input image, narrowing the measurement area shortens the processing time.

1. In the Item Tab area, tap [Region setting].
2. Tap [Edit].

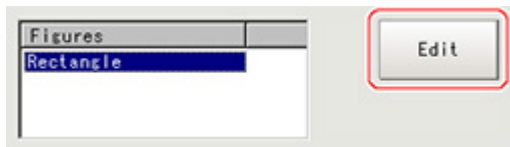

The figure setting area is displayed.

3. Specify the area in which to search for the model.
The rectangle covering the entire screen is set. Adjust the size and position of the rectangle.
4. Tap [OK].
The area to measure is registered.

Detection Point (ECM Search)

Specify a position in the model that should be used as the detection coordinates during measurement. Usually, the central position of the set model is registered as the detection point. This function is used to change to any desired position.

Note

- After changing the detection coordinates to another position, re-registering the model will change it back to the central coordinates of the model.

1. In the Item Tab area, tap [Detection point].
In the Image Display area, the current detection point is displayed with a crosshair cursor.

2. Tap the position to be set as the detection point.

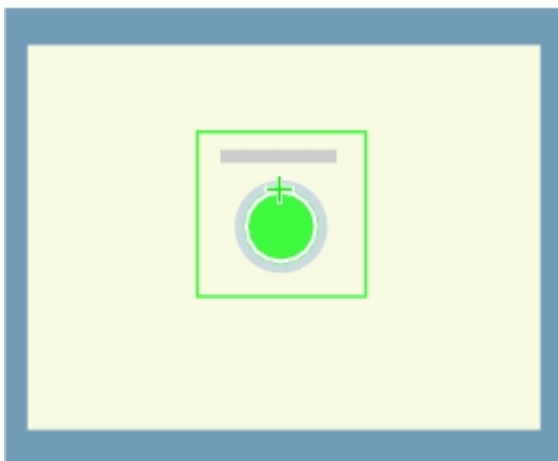
**Note**

- Displaying the image enlarged makes this tapping easier.
Reference: ▶ "Using the Zoom Function" in the "User's Manual" (p.347)

3. If necessary, finely adjust with numeric input and the arrow buttons.

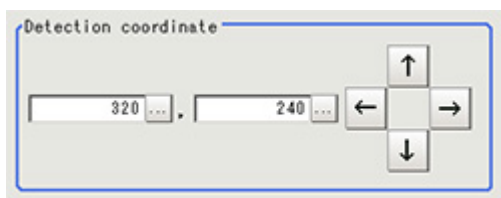

Reference Position (ECM Search)

When the measurement region is set, this position is automatically set at the same time as the reference position. This item can be used to change the reference position to any desired position. This is handy for measuring the positional deviation from a certain position.

1. In the Item Tab area, tap [Ref. position].
In the Image Display area, the current reference position will be displayed as the crosshair cursor.
2. Tap the position to be set as the reference position.

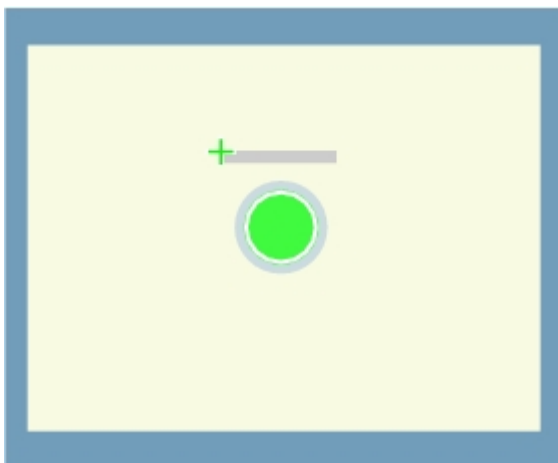

Note

- Displaying the image enlarged makes this tapping easier.
Reference: ▶ "Using the Zoom Function" in the "User's Manual" (p.347)

3. If necessary, finely adjust with numeric input and the arrow buttons.
To remeasure on the displayed image and set the reference position, tap [Measure ref.].

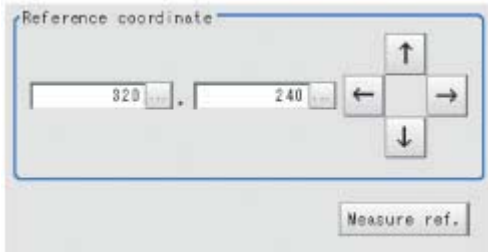

Measurement Parameters (ECM Search)

This item specifies the judgement condition for measurement results. Specify the criteria to judge the measurement result if the X and Y coordinates and the correlation with the model are OK.

1. In the Item Tab area, tap [Measurement].
2. In the "Measurement condition" area, specify a value for each item.

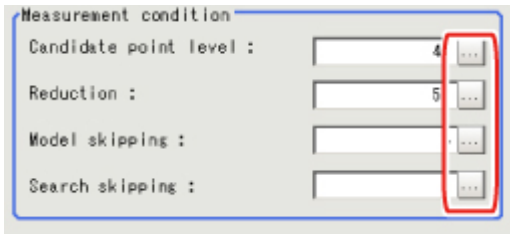

Setting item	Set value [factory default]	Description
Candidate point level	0 to 99 [40]	Specify the threshold value with which to detect candidate points in a rough search. Specify a smaller value for candidate point level when model search results are unstable.
Reduction	10 to 100 [50]	Specify the percentage to which the input image and the model image are reduced during a rough search. The more the image is reduced, the faster the processing becomes, but search results may be unreliable with a smaller image.
Model skipping	1 to 19 [4]	Specify how many pixels should be skipped when performing a rough search.
Search skipping	1 to 9 [2]	Specify how many pixels are skipped when performing a search for the "Search region".

3. When the setting has been changed, tap [Measurement] in the Detail area to verify whether measurements can be made correctly.



4. Set up the judgement condition.

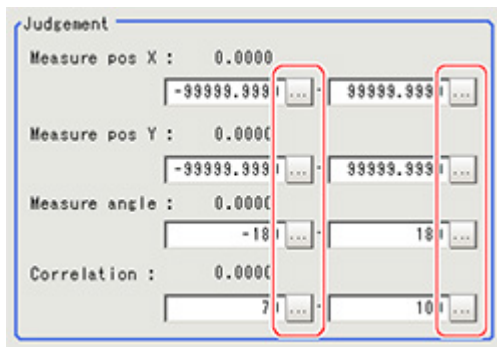

Note

- The values beside each item are measurement results of the displayed image. Take these values into consideration to determine the upper and lower limits.

Setting item	Set value	Description
Measure pos X	-99999.9999 to 99999.9999	Specify the range of X-axis shifting that is judged to be OK.
Measure pos Y	-99999.9999 to 99999.9999	Specify the range of Y-axis shifting that is judged to be OK.
Measure angle	-180 to 180	Specify the range of angles that are judged to be OK.
Correlation [Note 1]	0 to 100	Specify the range of correlation values that are judged to be OK.

[Note 1]: When the ECM correlation value of the measurement result is 0, the judgement result will be NG regardless of the measurement parameters setting.

Output Parameters (ECM Search)

Specify how to treat the coordinates to be output to the external device as measurement results. This item can be changed if necessary. Normally, the factory default value will be used.

Important

- After setting up the measurement parameters, changing the output parameters will cause measurement results to vary accordingly. If the output parameters have been changed, re-specify the measurement, too.

- Tap [Output parameter] in the Item Tab area.
- Specify each of the following items.

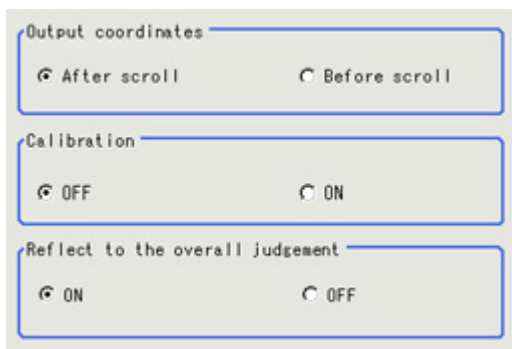

Setting item	Set value [factory default]	Description
Output Coordinates	<ul style="list-style-type: none"> · [After scroll] · Before scroll 	As measurement results, select whether to output coordinate values to external devices before or after the position deflection correction is applied.
Calibration	<ul style="list-style-type: none"> · [OFF] · ON 	Select whether to reflect the calibration in the values output to the external device as measurement results. ON: Output the coordinates converted into actual dimensions. OFF: Output the camera coordinate values.
Reflect to overall judgement	<ul style="list-style-type: none"> · [ON] · OFF 	Enables choosing whether or not the judgement results of this processing unit is reflected in the scene overall judgement.

Key Points for Test Measurement and Adjustment (ECM Search)

The following content is displayed in the "Detail result" area as text.

Displayed items	Description
Judge	Judgement result
Correlation	Correlation value
Position X	X coordinate of the position where the model is detected
Position Y	Y coordinate of the position where the model is detected
Angle	Angle of the position where the model is detected

Key Points for Adjustment

Select the adjustment method referring to the following points.

When the measurement results are unstable

Parameter to be adjusted	Remedy
Measurement	If images that should be judged OK vary greatly, specify a smaller value for "Candidate level".
	If the model image is small and unstable, specify a smaller value for the "Reduction".
Model register	Mask any unnecessary items.
	Lower the edge level.
	Register the error model.
Model parameter	If the measurement results are unstable only when "Rotation" is selected, specify a smaller value for the "Skipping angle".

When the processing speed is slow

Parameter to be adjusted	Remedy
Region setting	Make the search region as small as possible.

Model parameter	If images that should be judged OK vary little, specify a larger value for "Candidate level".
	When "Rotation" is selected and the model image is a simple figure, specify a larger value for "Skipping angle".
Measurement	Specify a smaller value of the "Reduction".
	Specify a larger value of the "Model skipping".
	Specify a larger value of the "Search skipping".

When Using Measurement Results Externally (ECM Search)

The following values can be output using processing items related to results output. It is also possible to reference measurement values from expressions and other processing units.

Measurement items	Character string	Description
Judgement	JG	Judgement result
Correlation value	CR	Correlation with the model
Measure X	X	X coordinate of the position where the model is detected
Measure Y	Y	Y coordinate of the position where the model is detected
Measurement angle	TH	Angle of the position where the model is detected
Measurement magnification MX	MX	X-axis magnification of the detected model
Measurement magnification MY	MY	Y-axis magnification of the detected model
Reference coordinate X	SX	X coordinate of the reference position of the registered model
Reference coordinate Y	SY	Y coordinate of the reference position of the registered model
Reference angle	ST	Angle of the registered model
Detection point RX	RX	X coordinate of the registered model
Detection point RY	RY	Y coordinate of the registered model

EC Circle Search

This processing item searches the input image for parts having a high degree of similarity to the target circle mark (model), and measures its circle evaluated value (similarity) and position. In a normal search, image pattern models are used that look at the color and light/dark information. In EC Circle Search, however, models are used that look at the profile. Therefore, this processing assures a reliable search even for low-contrast or noisy images. It is also possible to measure the number of circles in the input image.

Used in the Following Case

- This counts how many circles there are of the specified size. Since circles are extracted using the shape information in "Round", the circles being deformed or dirty does not affect counting.

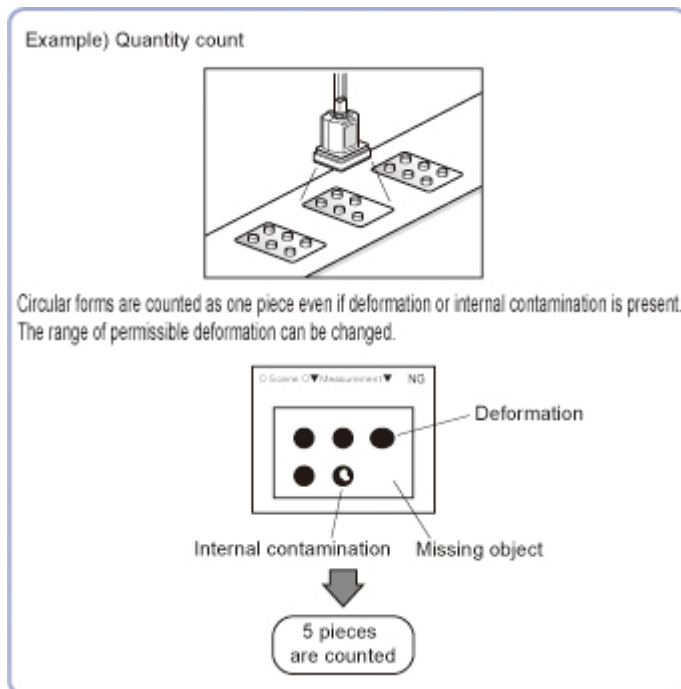

Settings Flow (EC Circle Search)

Set up EC circle search according to the following steps.

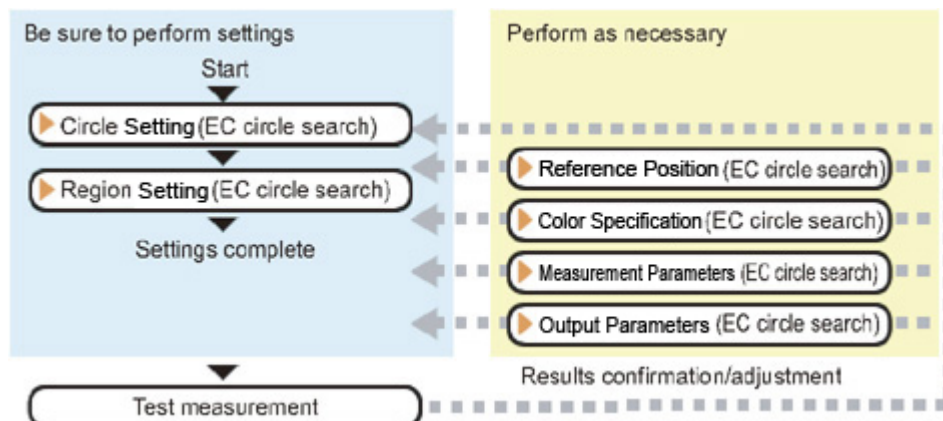

List of EC Circle Search Items

EC circle search items are explained below.

Item name	Description
Circle register	This item sets the size of the circle to search for. Reference: ▶ Circle Setting (EC Circle Search) (p.91)
Region setting	This item is used to set up the measurement area. Narrowing the measurement area instead of measuring the entire input screen shortens the processing time. Reference: ▶ Region Setting (EC Circle Search) (p.92)
Ref. position	This item can be changed if necessary. Usually, the central position of the registered region is specified as the reference position. Reference: ▶ Reference Position (EC Circle Search) (p.93)
Color setting	This item can be changed if necessary. Select the color of the circle and the background color. If no check is placed at color setting, the circle (edge) is extracted using the brightness difference. Reference: ▶ Color Specification (EC Circle Search) (p.94)
Measurement	This item changes the measurement parameter as necessary when the measurement result is unstable. Reference: ▶ Measurement Parameters (EC Circle Search) (p.95)
Output parameter	This item can be changed if necessary. Normally, the factory default value will be used. Use the output parameter to specify how to handle the coordinates. Reference: ▶ Output Parameters (EC Circle Search) (p.97)

Circle Setting (EC Circle Search)

This item registers the size of the circle to search for.
Set the circle size only with the circumference figure.

1. In the Item Tab area, tap [Circle register].
When setting a new circle, you do not need to tap [Circle register].
2. Set the search circumference using the drawing tools.



3. In the figure setting area, tap [OK].
The circle to search for is registered.
4. Tap [Edge extraction] and set values.
Reference: ▶ Extracting edges (p.91)

Extracting Edges

In an EC circle search, processing is executed on the edge extraction image. Change this item as necessary when the edge is not extracted or is extracted along with noise.

1. In the Item Tab area, tap [Edge extraction].
2. In the "Edge extraction setting" area, tap [...] or [▼] for each item and set the values.
The "Edge level" value can be specified by dragging the slider or tapping one of the buttons at either end of the slider.

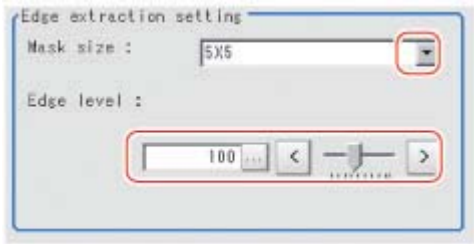

Setting item	Set value [factory default]	Description
Mask size	<ul style="list-style-type: none"> • 3x3 • [5x5] • 7x7 • 9x9 	Select the range of pixels which are used to extract the edge. With a larger mask size, search is less affected by variation in pixels.
Edge level	0 to 255 [100]	Adjust the edge extraction level when the edge is hard to see due to low contrast with the background or when unnecessary background noise should be removed.

Region Setting (EC Circle Search)

Specify the rectangular area in which to search for the circle.
Instead of measuring the entire input image, narrowing the measurement area shortens the processing time.

1. In the Item Tab area, tap [Region setting].
2. Tap [Edit].



- The figure setting area is displayed.
3. Specify the area in which to search for the model.
The rectangle covering the entire screen is set. Adjust the size and position of the rectangle.
 4. Tap [OK].
The measurement region is registered and displayed in the Image Display area.

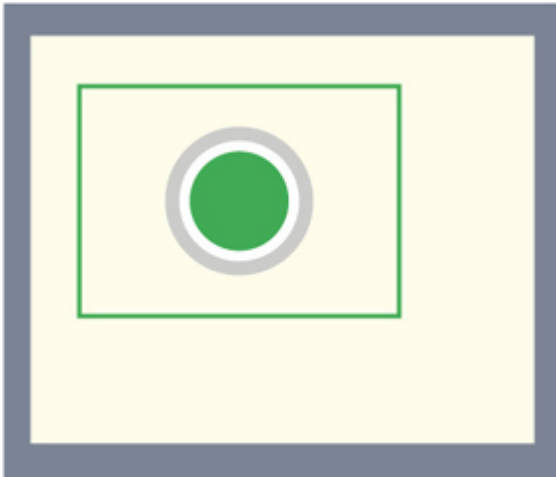

Reference Position (EC Circle Search)

When the circle size is registered, this position is automatically set at the same time as the reference position.

This item can be used to change the reference position to any desired position. This is handy for measuring the positional deviation from a certain position.

For the reference position, see Reference: ▶ "User's Manual", "Terminology Explanations" (p.339) .

1. In the Item Tab area, tap [Ref. position].

In the Image Display area, the current reference position will be displayed as the crosshair cursor.

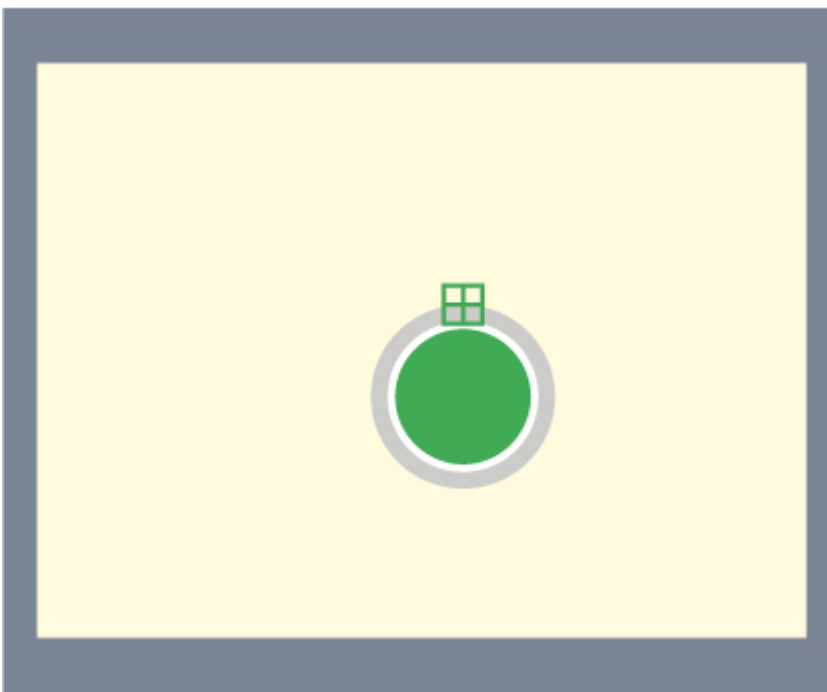

2. Tap the position to be set as the reference position.
3. If necessary, finely adjust with numeric input and the arrow buttons.
To remeasure on the displayed image and set the reference position, tap [Measure ref.].

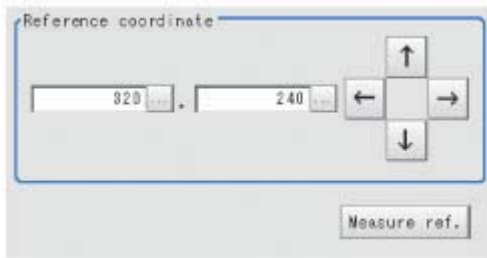

Color Specification (EC Circle Search)

This item can be changed if necessary.

Select the color of the circle and the background color. If no check is placed at color setting, the circle (edge) is extracted using the brightness difference.

1. In the Item Tab area, tap [Color setting].
2. If necessary, check "Color setting" in the "Color setting" area.

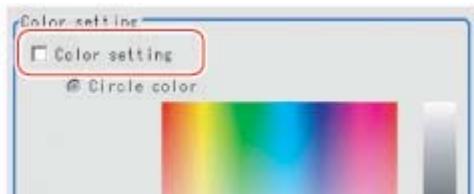

3. Specify a color.
Enclose the location on the image to be set as the circle and the background color with a rectangle. The average color of the enclosed range is set for R, G, and B. R, G, and B values can also be set with numbers. To input the values, tap [...] for each of "R" (red), "G" (green), and "B" (blue). Specify the circle color and the background color separately.

Value input method: Reference: ▶ See the "User's Manual", "Inputting Values" (p.343)

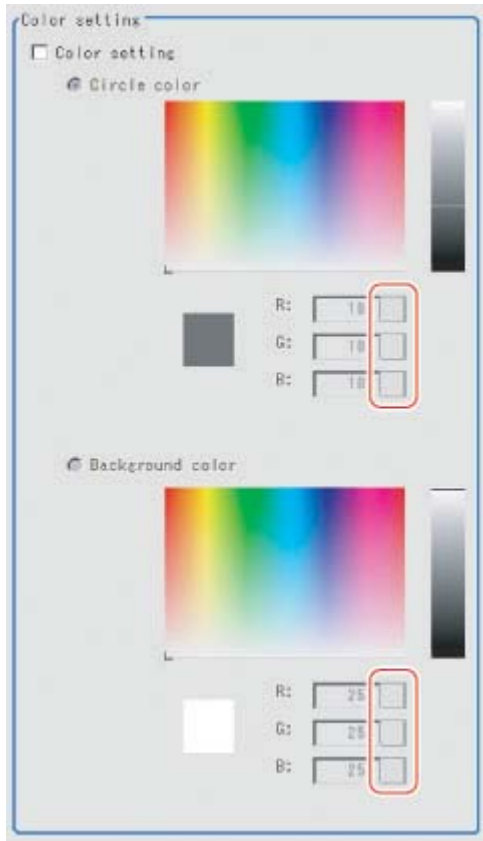

Measurement Parameters (EC Circle Search)

This item specifies the judgement conditions for measurement results. Specify to what degree OK is still judged in relation to measurement result coordinates (X,Y) and the circle evaluation value with the model.

1. In the Item Tab area, tap [Measurement].
2. Select the search type.



Setting item	Set value [factory default]	Description
Search type	[Single search]	This is set when there is one circle in the measurement range.
	Multi search	This is set when there are multiple circles in the measurement range.

3. Set the measurement conditions.
For single search

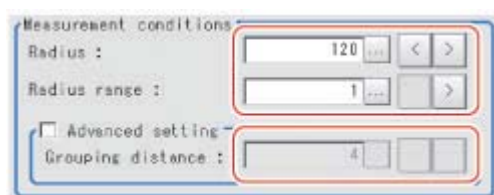

For multi search

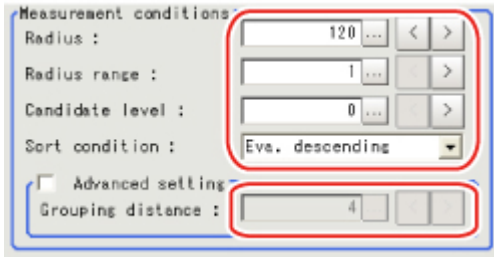

Setting item	Set value [factory default]	Description
Radius	1 to 9999 [Radius drawn using circle resister]	This item sets the radius of the circle measured. This is displayed on the screen with a solid blue line.
Radius range	[1] to 9999	This measures the measured circle radius \pm the permitted radius width. This is displayed on the screen with a broken blue line.
Candidate level (Multi search only)	[0] to 100	Specify the threshold value used when detecting candidate points in an EC circle search. Specify a smaller value when model search results are unreliable.
Sort condition (Multi search only)	<ul style="list-style-type: none"> • X ascending • X descending • Y ascending • Y descending • Eva. ascending • [Eva. descending] • Radius ascending • Radius descending 	Specify the conditions by which label number is re-assigned. When sorting referencing the X and Y coordinates, the upper left is the origin.
Advanced setting	<ul style="list-style-type: none"> • Checked • [Unchecked] 	Place a check in order to set the grouping distance.
Grouping distance	1 to 10 [4]	When circles measured overlap, this sets the distance for distinguishing circles. The smaller this value, the easier to distinguish circles.

For monochrome cameras:

For a monochrome camera only, the circle color parameters are displayed.

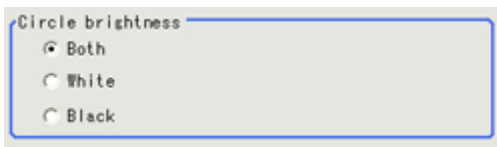

Setting item	Set value [factory default]	Description
Circle brightness	<ul style="list-style-type: none"> • [Both] • White • Black 	This sets the circle color with the brightness.

4. Set up the judgement condition.

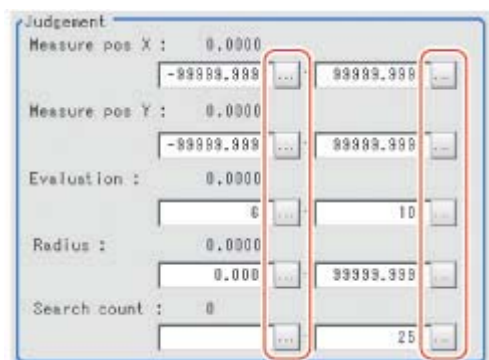

Note

- The values beside each item are measurement results of the displayed image. Take these values into consideration to determine the upper and lower limits.

Setting item	Set value	Description
Measure pos X	-99999.9999 to 99999.9999	Specify the range of X-axis shifting that is judged to be OK.
Measure pos Y	-99999.9999 to 99999.9999	Specify the range of Y-axis shifting that is judged to be OK.
Evaluation	0 to 100	Specify the range of circle evaluated values that are judged to be OK.
Radius	0 to 99999.9999	Specify the area range of radiuses that is judged to be OK.
Search count	0 to 255	Specify the range of quantities that is judged to be OK.

Output Parameters (EC Circle Search)

Specify how to treat the coordinates to be output to the external device as measurement results. This item can be changed if necessary. Normally, the factory default value will be used.

Important

- After setting up the measurement parameters, changing the output parameters will cause measurement results to vary accordingly. If the output parameters have been changed, re-specify the measurement, too.

1. Tap [Output parameter] in the Item Tab area.

2. Specify a value for the items.

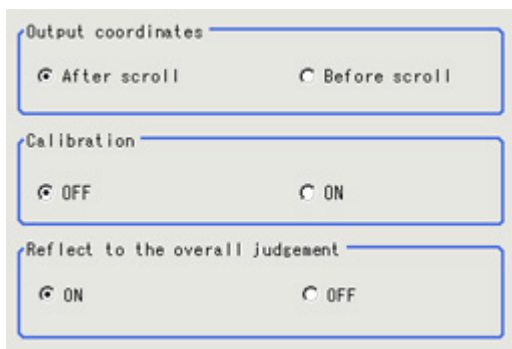

Setting item	Set value [factory default]	Description
Output Coordinates	<ul style="list-style-type: none"> • [After scroll] • Before scroll 	As measurement results, select whether to output coordinate values to external devices before or after the position deflection correction is applied.
Calibration	<ul style="list-style-type: none"> • [OFF] • ON 	Select whether to reflect the calibration in the values output to the external device as measurement results. ON: Output the coordinates converted into actual dimensions. OFF: Output the camera coordinate values.
Reflect to the overall judgement	<ul style="list-style-type: none"> • [ON] • OFF 	Enables choosing whether or not the judgement results of this processing unit is reflected in the scene overall judgement.

Note

- For details on output coordinates and calibration, see Reference: ▶ "User's Manual", "Handling Coordinates" (p.337) .

Key Points for Test Measurement and Adjustment (EC Circle Search)

The following content is displayed in the "Detail result" area as text.

Displayed items	Description
Judge	Judgement result
Position X	X coordinate of the position where the model is detected
Position Y	Y coordinate of the position where the model is detected
Evaluation	Circle evaluated value of circles detected
Radius	Radius of circles detected
Search count	Quantity of circles detected

Key Points for Adjustment

Select the adjustment method referring to the following points.

When the measurement results are unstable

Parameter to be adjusted	Processing
Measurement	If images that should be judged OK vary greatly, specify a smaller value for "Evaluation".

Circle register	Mask any unnecessary items. Lower the edge level.
-----------------	--

When the processing speed is slow

Parameter to be adjusted	Processing
Region setting	Make the search region as small as possible.
Measurement	If images that should be judged OK vary little, specify a larger value for "Evaluation".

Measurement Results for Which Output Is Possible (EC Circle Search)

The following values can be output using processing items related to results output. It is also possible to reference measurement values from expressions and other processing units.

Measurement items	Character string	Description
Judgement	JG	Judgement result
Measurement coordinate X	X	X coordinate of the position where the circle is detected
Measurement coordinate Y	Y	Y coordinate of the position where the circle is detected
Reference position X	SX	X coordinate of the reference position of the registered circle
Reference position Y	SY	Y coordinate of the reference position of the registered circle
EC correlation value	CR	Evaluated value of circle detected
Radius	RA	Radius of circles detected
Count	CT	Quantity of circles detected
Position N	XN	Detected circle N position X (N = 0 to 255)
Position N	YN	Detected circle N position Y (N = 0 to 255)
Evaluation N	CRN	Detected circle N circle evaluated value (N = 0 to 255)
Radius N	RAN	Detected circle N circle radius (N = 0 to 255)

Shape Search+

This is a processing item for just FZ3-H □□□ series high grade controllers.

This processing item searches the input image for parts having a high degree of similarity to the target mark (model) and detects its correlation value (similarity) and position at high speed.

In a normal search, image pattern models are used that look at the color and light/dark information, but in a shape search, models are used that look at the profile information. Therefore, this processing assures a reliable search even for low-contrast or noisy images. It is also possible to search reliably for marks of difference size.

This is used to search at higher speed than for an ECM search.

Used in the Following Case

- To measure the location of a mark

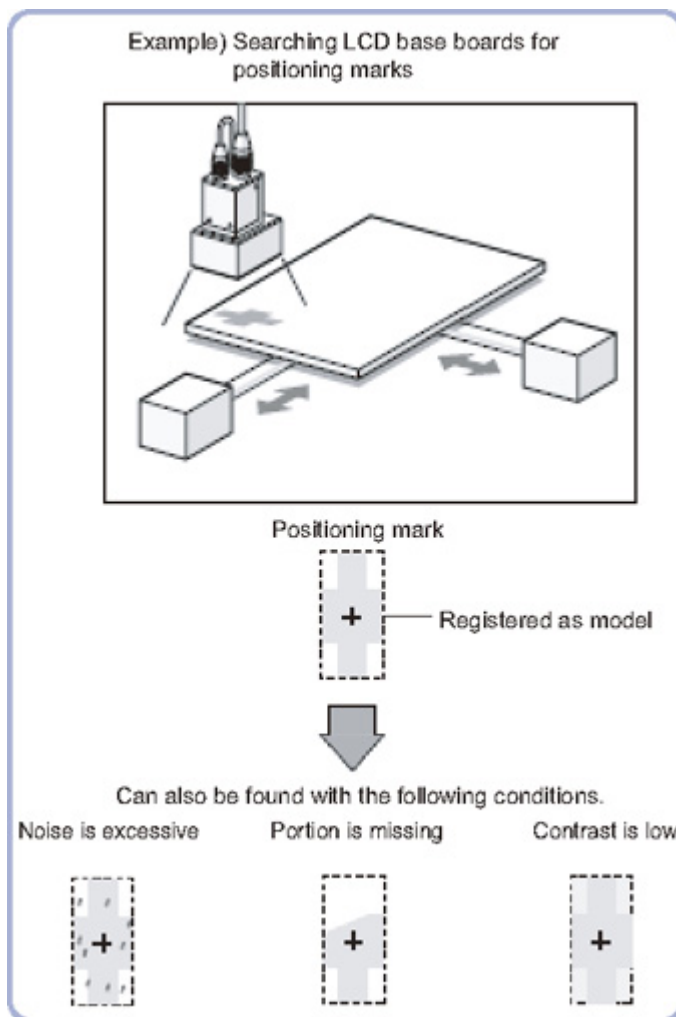

Important

- When FZ3-H □□□ series dedicated processing items are used, processing is carried out that reduces the processing time from the second time on. Therefore, when measuring the same image, the processing for the first time after the controller is started up may be longer than the processing time from the second time on.
- This processing item is for monochrome only. When using a color camera, put in the color gray filter. If a color image is input, it is NG (incompatible image).

Settings Flow (Shape Search+)

Set up shape search+ according to the following steps.

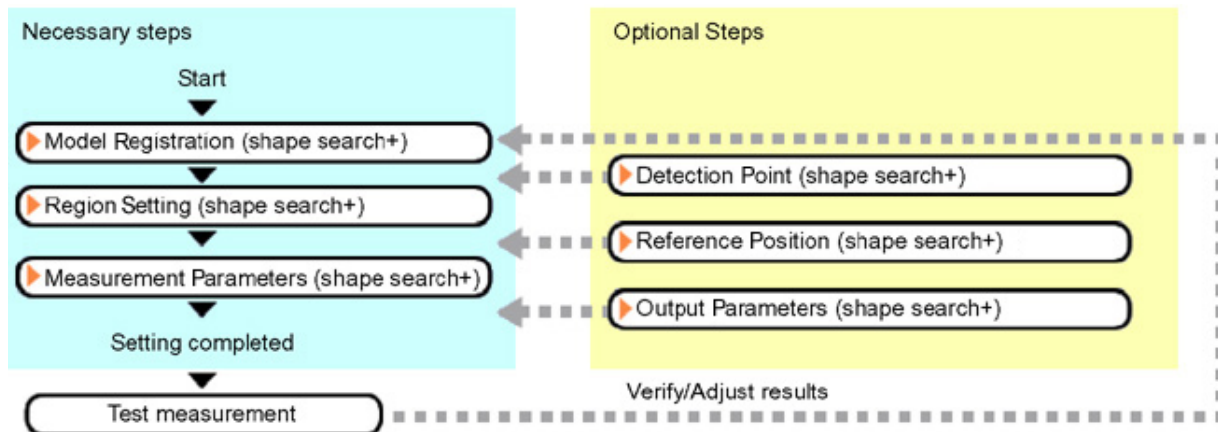

List of Shape Search+ Items

Item name	Description
Model register	This item registers the pattern characteristic of the measurement image as a model. Model parameter values can be changed as needed to address unstable measurement results or to increase the processing speed. Normally, the factory default value will be used. Reference: ▶ Model Registration (Shape Search+) (p.101)
Region setting	This item is used to set up the measurement area. Restricting the range enables accurate measurement in a short period of time. Reference: ▶ Region Setting (Shape Search+) (p.103)
Detection point	This item can be changed if necessary. Specify a position in the model that should be used as the detection coordinates during measurement. Usually, the central position of the set model is registered as the detection coordinates. Reference: ▶ Detection Point (Shape Search+) (p.103)
Ref. position	This item can be changed if necessary. Usually, the central position of the registered region is registered as the reference position. Reference: ▶ Reference Position (Shape Search+) (p.104)
Measurement	This item specifies the judgement condition for measurement results. Specify the correlation value, sort condition, and label number. Measurement parameter can be changed as needed to address unstable measurement results or to increase the processing speed. Normally, the factory default value will be used. Reference: ▶ Measurement Parameters (Shape Search+) (p.105)
Output parameter	This item can be changed if necessary. Normally, the factory default value may be used. Use the output parameter to specify how to handle the coordinates. Reference: ▶ Output Parameters (Shape Search+) (p.106)

Model Registration (Shape Search+)

Register the parts to measure as the model.

The position at the time of registration is also registered in the model information. Place the measurement object in the correct position when registering a model.

1. In the Item Tab area, tap [Model register].
When setting a new model, you do not have to tap [Model register].

2. Use the drawing tools to specify the model registration range.

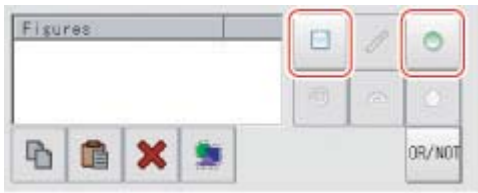

3. This sets the model parameter.

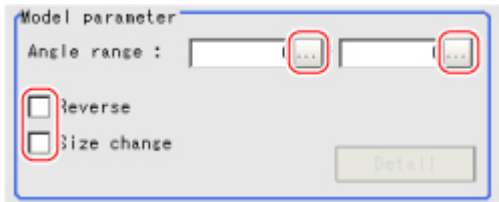

Setting item		Set value [factory default]	Description
Angle range	Upper limit	-180 to 180 [0]	When the measurement object is rotating, set how large the angle range is for creating rotated models. The skipping angle is set automatically.
	Lower limit	-180 to 180 [0]	
Reverse		<ul style="list-style-type: none"> • Checked • [Unchecked] 	Specify whether to allow the reverse of light and dark for the model.
Size change		<ul style="list-style-type: none"> • Checked • [Unchecked] 	This is set when the size of measurement objects changes. When checked, tap [Detail setting] and specify a value for each item.

4. When the "Size change" option is checked, tap [Detail setting].
The "Model parameter: Size change" area is displayed.

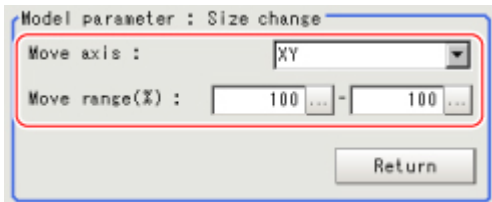

Setting item		Set value [factory default]	Description
Move axis		<ul style="list-style-type: none"> • [XY] • X • Y 	Specify the model variable direction.
Move range	Upper limit	[100] to 110	Specify the range in which to change the model size.
	Lower limit	90 to [100]	

5. Tap [Return].
The "Model parameter" area is displayed.

Important

- Set the region such that the number of pixels in the model region is 995328 pixels or less.
- Sometimes detection exceeds the set angle range.
- When the angle range is set and the image registered as a model is measured, some error occurs in the rotation angle.

Region Setting (Shape Search+)

Use a rectangle to specify the area where the model is searched.
Restricting the measurement area can shorten the processing time.

1. In the Item Tab area, tap [Region setting].
2. Tap [Edit].

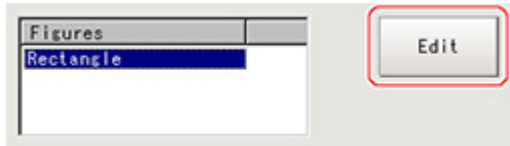

The figure setting area is displayed.

3. Specify the area in which to search for the model.
The rectangle covering the entire screen is set. Adjust the size and position of the rectangle.
4. Tap [OK].
The area to measure is registered.

Important

- Set the region such that the number of pixels in the measurement region is 5003712 pixels or less.

Detection Point (Shape Search+)

Specify a position in the model that should be used as the detection coordinates during measurement. Usually, the central position of the set model is registered as the detection point. This function is used to change to any desired position.

Note

- After changing the detection coordinates to another position, re-registering the model will change it back to the central coordinates of the model.

1. In the Item Tab area, tap [Detection point].
In the Image Display area, the current detection point is displayed with a crosshair cursor.
2. Tap the position to be set as the detection point.

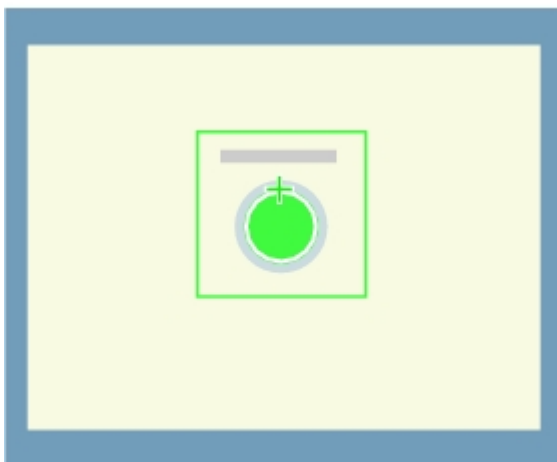

Note

- Displaying the image enlarged makes this tapping easier.
Reference: ▶ "Using the Zoom Function" in the "User's Manual" (p.347)

3. If necessary, finely adjust with numeric input and the arrow buttons.

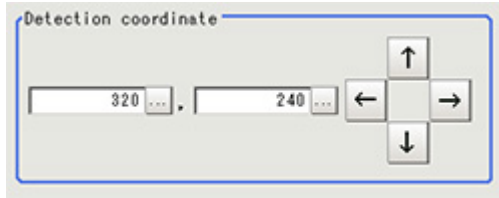

Reference Position (Shape Search+)

When the model is set, this position is automatically set at the same time as the reference position. This item can be used to change the reference position to any desired position. This is handy for measuring the positional deviation from a certain position.

1. In the Item Tab area, tap [Ref. position].
In the Image Display area, the current reference position will be displayed as the crosshair cursor.
2. Tap the position to be set as the reference position.

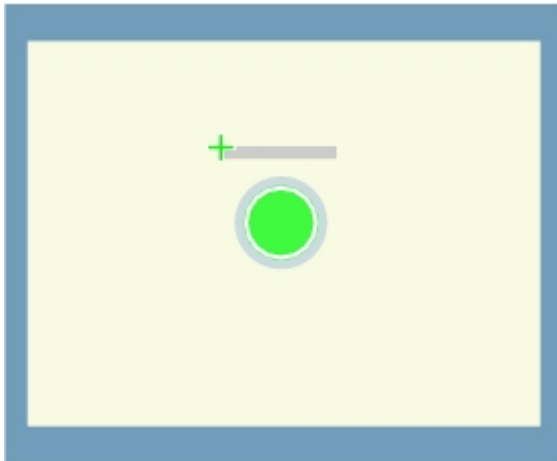
**Note**

- Displaying the image enlarged makes this tapping easier.
Reference: ▶ "Using the Zoom Function" in the "User's Manual" (p.347)

3. If necessary, finely adjust with numeric input and the arrow buttons.
To remeasure on the displayed image and set the reference position, tap [Measure ref.].

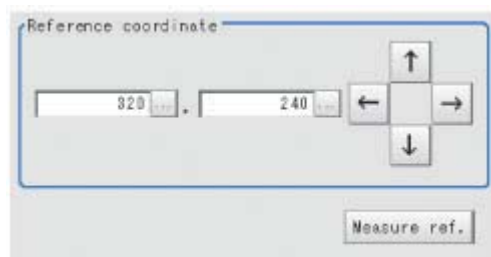

Measurement Parameters (Shape Search+)

Specify the shape search+ measurement conditions and the judgement conditions for the measurement results.

1. In the Item Tab area, tap [Measurement].
2. In the "Measurement condition" area, specify a value for each item.

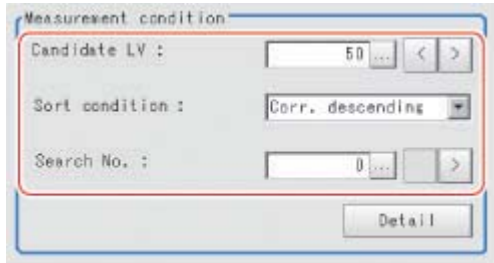

Setting item	Set value [factory default]	Description
Candidate level	30 to 100 [50]	Specify the threshold value with which to detect candidate points in a rough search. Specify a smaller value when model search results are unreliable.
Sort condition	<ul style="list-style-type: none"> • Corr. ascending • [Corr. descending] • X ascending • X descending • Y ascending • Y descending 	Set the sorting method for the measurement results.
Search No.	[0] to 99	Input the search number for outputting the data.

3. You can set the following conditions details by tapping [Detail setting].

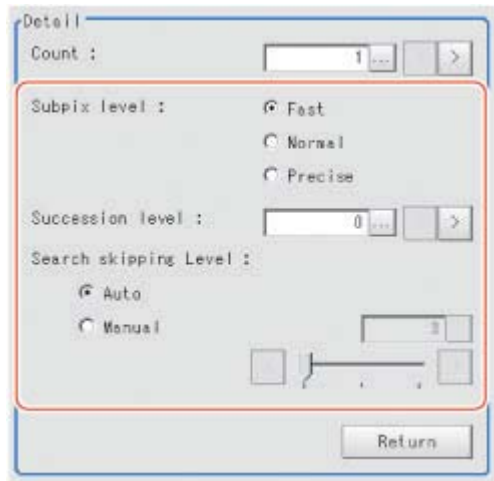

Setting item	Set value [factory default]	Description
Count	[1] to	Specify the number of targets to be detected.
Subpix level	[Fast] Normal Precise	This is set when measuring the position information in sub-pixel units. To emphasize precision, select [Precise]. When [Precise] is selected, this requires more processing time.

Succession level		[0] to 100	Specify the allowable overlapping range to be detected for detected images. 0: Do not allow overlapping - 100: Allow overlapping
Search skipping Level	Auto	<ul style="list-style-type: none"> · [Checked] · Unchecked 	Specify how many pixels are skipped when performing a measurement of the measurement region. When automatic is selected, the search level is set automatically.
	Manual	[3] to 5	

- When the setting has been changed, tap [Measurement] in the Detail area to verify whether measurements can be made correctly.



- Set up the judgement condition.

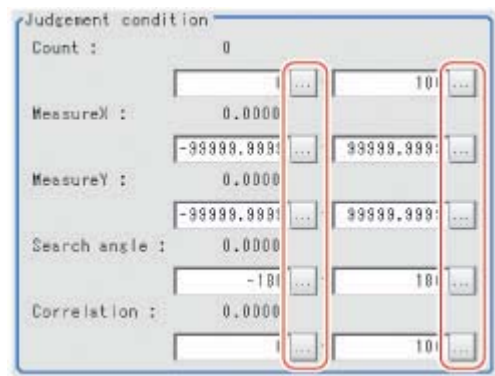

Setting item	Set value	Description
Count	0 to 100	Specify the number of detections to be judged as OK.
Measure X	-99999.9999 to 99999.9999	Specify the range of X-axis shifting that is judged to be OK.
Measure Y	-99999.9999 to 99999.9999	Specify the range of Y-axis shifting that is judged to be OK.
Search angle	-180 to 180	Specify the range of angles that are judged to be OK.
Correlation	0 to 100	Specify the range of correlation values that are judged to be OK. However, when the correlation value of the measurement result is 0, the judgement result will be NG regardless of the lower limit setting.

Output Parameters (Shape Search+)

Specify how to treat the coordinates to be output to the external device as measurement results. This item can be changed if necessary. Normally, the factory default value will be used.

Important

- After setting up the measurement parameters, changing the output parameters will cause measurement results to vary accordingly. If the output parameters have been changed, re-specify the measurement, too.

- Tap [Output parameter] in the Item Tab area.

2. Specify each of the following items.

Output coordinates
 After scroll Before scroll

Calibration
 OFF ON

Reflect to the overall judgement
 ON OFF

Setting item	Set value [factory default]	Description
Output coordinates	<ul style="list-style-type: none"> • [After scroll] • Before scroll 	As measurement results, select whether to output coordinate values to external devices before or after the position deflection correction is applied.
Calibration	<ul style="list-style-type: none"> • [OFF] • ON 	Select whether to reflect the calibration in the values output to the external device as measurement results. ON: Output the coordinates converted into actual dimensions. OFF: Output the camera coordinate values.
Reflect to the overall judgement	<ul style="list-style-type: none"> • [ON] • OFF 	Enables choosing whether or not the judgement result of this processing unit is reflected in the scene overall judgement.

Key Points for Test Measurement and Adjustment (Shape Search+)

The following content is displayed in the "Detail result" area as text.

Displayed items	Description
Judge	Judgement result
Count	Count
Correlation	Correlation value
Position X	X coordinate of the position where the model is detected
Position Y	Y coordinate of the position where the model is detected
Angle	Angle of the position where the model is detected

Key Points for Adjustment

Select the adjustment method referring to the following points.

When the measurement results are unstable

Parameter to be adjusted	Remedy
Model parameter	<p>Register the model from the following two perspectives.</p> <ul style="list-style-type: none"> Register the model figure frame enclosing the boundaries of the target. In order to detect based on the edge information, improvement is made by including boundary information in the registration. When a model is registered near the boundary of the image or measurement region, some targets may be impossible to detect. Register the model leaving space from the boundary of the image or measurement region.
Measurement	<ul style="list-style-type: none"> Specify a larger value for "Candidate level". Specify a smaller value for the "Search skipping Level" in the detailed settings. <p>These two settings have a trade-off with speed. Make the setting taking the affect on speed into consideration.</p>

When the processing speed is slow

Parameter to be adjusted	Remedy
Model parameter	Specify a narrower "Angle range".
Region setting	Specify a smaller value for "Region".
Measurement	<ul style="list-style-type: none"> Set the "Subpix level" in the detailed settings to "Fast". This setting has a trade-off with precision. Change this setting according to what the application is used for. Specify a larger value for "Candidate level". Specify a smaller value for the "Search skipping Level" in the detailed settings. <p>These two settings have a trade-off with speed. Make the setting taking the affect on speed into consideration.</p>

Measurement Results for Which Output Is Possible (Shape Search+)

The following values can be output using processing items related to results output. It is also possible to reference measurement values from expressions and other processing units.

Displayed items	Description	Description
Judgement	JG	Judgement result
Count	C	Count
Correlation value	CR	Correlation with the model
Measurement coordinate X	X	Measure X
Measurement coordinate Y	Y	Measure Y
Measurement angle	TH	Measure angle
Magnification X	MX	Magnification X
Magnification Y	MY	Magnification Y
Reference position X	SX	Reference
Reference position Y	SY	Reference
Reference angle	ST	Reference angle
Detection point X	RX	Detected coordinate X
Detection point Y	RY	Detected coordinate Y
Correlation 0	CR00	Correlation 0

Position X0	X00	Position X0
Position Y0	Y00	Position Y0
Angle 0	TH00	Angle 0
Magnification MX0	MX00	Magnification MX0
Magnification MY0	MY00	Magnification MY0
Correlation 1	CR01	Correlation 1
Position X1	X01	Position X1
Position Y1	Y01	Position Y1
Angle 1	TH01	Angle 1
Magnification MX1	MX01	Magnification MX1
Magnification MY1	MY01	Magnification MY1
.	.	.
.	.	.
.	.	.
Correlation 31	CR31	Correlation 31
Position X31	X31	Position X31
Position Y31	Y31	Position Y31
Angle 31	TH31	Angle 31
Magnification MX31	MX31	Magnification MX31
Magnification MY31	MY31	Magnification MY31

Classification

Used in the Following Case

- When various kinds of products on a production line need to be classified and identified

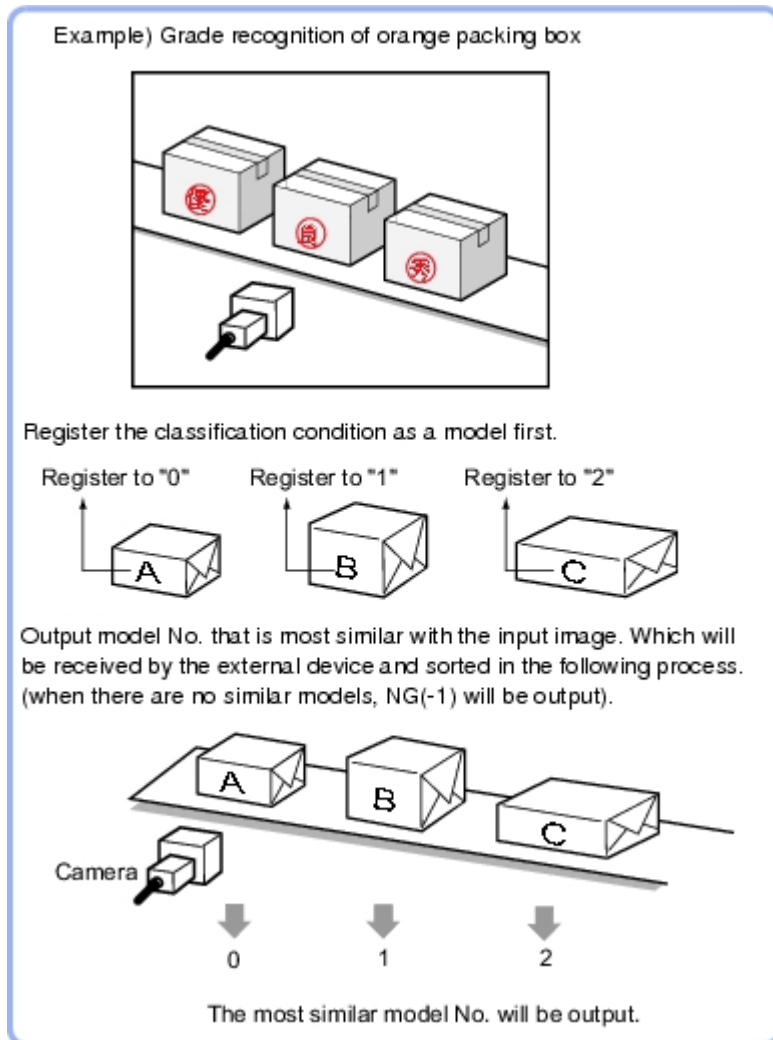

Settings Flow (Classification)

Classification can be set up as follows.

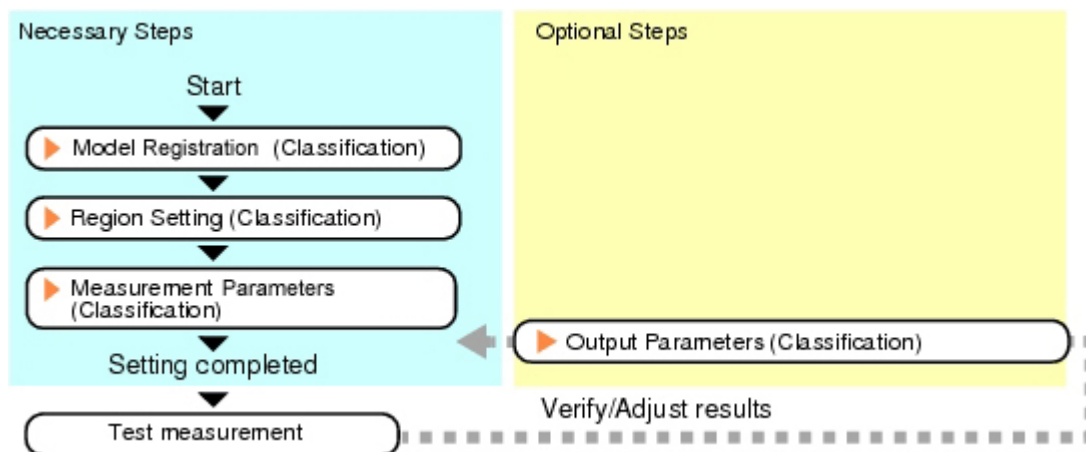

List of Classification Items

Item name	Description
Model register	This item registers the pattern characteristic of the measurement image as a model. Model parameter values can be changed as needed to address unstable measurement results or to increase the processing speed. Normally, the factory default value will be used. Reference: ▶ Model Registration (Classification) (p.111)
Region setting	This item is used to set up the measurement area. Instead of measuring the entire input image, narrowing the measurement area shortens the processing time. Reference: ▶ Region Setting (Classification) (p.115)
Measurement	This item specifies the judgement condition for measurement results. Specify the criteria to judge the measurement result if the X and Y coordinates and the correlation with the model are OK. Reference: ▶ Measurement Parameters (Classification) (p.116)
Output parameter	This item can be changed if necessary. Normally, the factory default value will be used. Use the output parameter to specify how to handle the coordinates. Reference: ▶ Output Parameters (Classification) (p.117)

Model Registration (Classification)

Pre-register as models the sections to be used as reference for classification.

Models can be registered with any of 36 indexes, from 0 to 35, and up to 5 models can be registered for each index.

When there is variation among the model print quality and shapes, pre-register multiple models for the same index.

1. In the Item Tab area, tap [Model register].

2. In the "Setting model" area, select a model and tap [New].

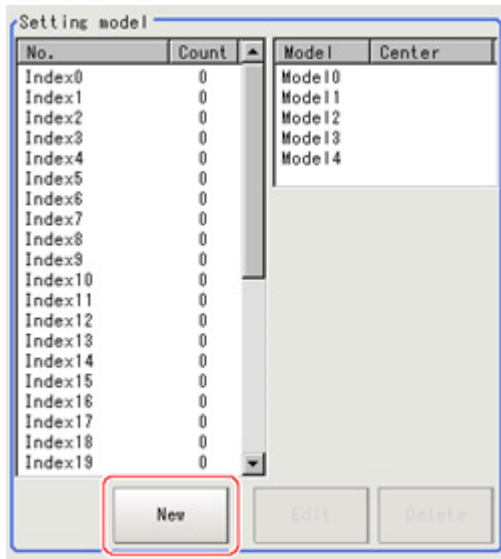

3. Use the drawing tools to specify the model registration range.

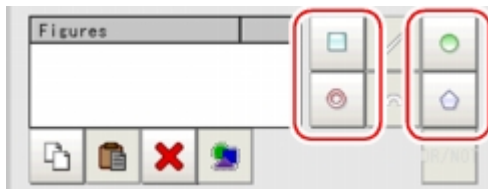



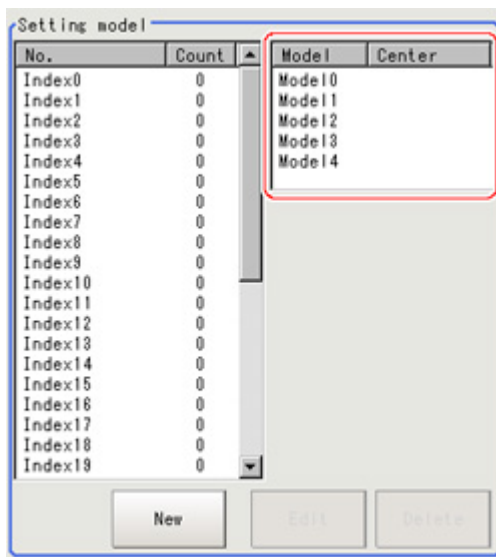

4. Tap [OK].

The model is registered and its center X and Y coordinate values are displayed in the "Setting model" area.



The image specified for the model is displayed in the Image Display area.

0		12	24
1		13	25
2		14	26
3		15	27
4		16	28
5		17	29
6		18	30
7		19	31
8		20	32
9		21	33
10		22	34
11		23	35

Note**Model Status and Measurement Processing**

- Measurement time and accuracy may be affected by the status of model in the following ways. Please select measurement objects that are in good condition (clean) for Model Registration.
 - In the case of large or complicated models, processing time is prolonged.
 - With extremely small models or models without features, search processing is unstable.

5. To register two or more models, repeat the Steps Reference: ▶ 2(p.112) to Reference: ▶ 4(p.112) .

Note

- When a model is registered, the central coordinates of the model are registered as the detection point. A detection point is a point output as a measurement value. If multiple figures are combined, the central coordinates of the circumscribed rectangle are registered.

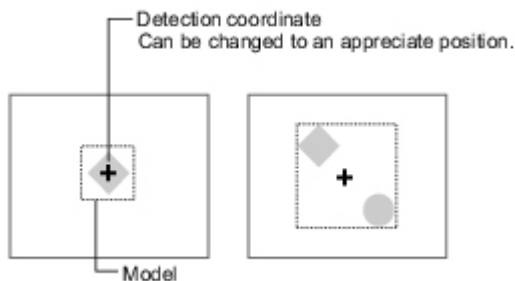
**Changing Model Parameters**

Model parameter values can be changed as needed to address unstable measurement results or to increase the processing speed. Normally, the factory default value will be used.

After changing a setting, re-register the model.

1. In the "Model parameter" area, select the search mode, then specify a value for each item for

that mode.

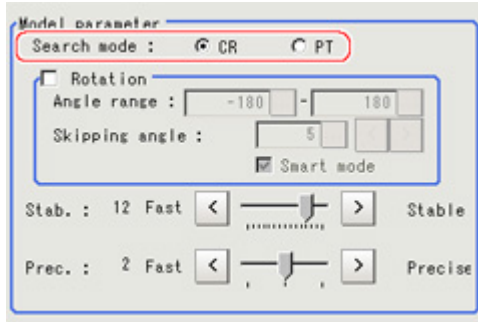

Setting item	Set value [factory default]	Description
Search mode	[CR]	Search normalizing the brightness. This method can provide reliable measurement when there is fluctuation in the overall brightness and when the image has low contrast.
	PT	Measures with the degree of matching to the profile of the model. This method can measure at higher speed when the rotation angle has a wide range. It is available only when a 0.3 megapixel color camera is connected.

When CR is selected

Setting item	Set value [factory default]	Description
Rotation	Checked [Unchecked]	When the measurement object is rotating, place a check at "Rotation" and specify how many degrees the model created rotates each time and through what range of angles. A smaller skipping angle increases stability, but slows down the processing. The normal direction is clockwise.
Angle range	[-180 to 180]	
Skipping angle	1 to 30 [5]	
Smart mode	[Checked] Unchecked	Checking the "Smart mode" option enables a high-speed rotation search. However, the stability may be lowered when the model shape aspect ratio is large or when the NOT mask is used.
Stability	1 to 15 [The default value depend on the connected camera. 9 or 12]	Specify which is to have priority, measurement stability or speed. If lowering stability does not speed up processing, it is likely that many candidates have been detected. In this case, specify a larger value for "Candidate level" or "Stab."
Preciseness	1 to 3 [2]	Specify which is to have priority, measurement positional precision or speed.

When PT is selected

Setting item	Set value [factory default]	Description
Angle range	[-180 to 180]	This item specifies the rotation angle range for searching. The normal direction is clockwise.
Stability	1 to 5 [3]	If lowering stability does not speed up processing, it is likely that many candidates have been detected. In this case, specify a larger value for "Candidate level" or "Stab."

Deleting a Model

Deletes a registered model.

1. Select the model from the list and tap [Delete].

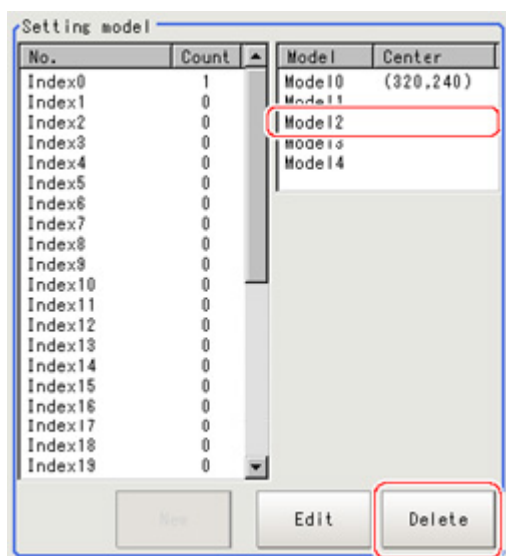

Region Setting (Classification)

Use the rectangle to set up the measurement region for [Classification].

1. In the Item Tab area, tap [Region setting].
2. Tap [Edit].

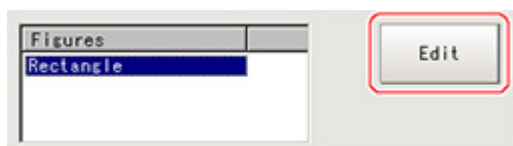

The figure setting area is displayed.

3. Specify the area in which to search for the model.
The rectangle covering the entire screen is set. Adjust the size and position of the rectangle.
4. Tap [OK].
The area to measure is registered.

Measurement Parameters (Classification)

Specify the search measurement conditions and the judgement conditions for the measurement results.

1. In the Item Tab area, tap [Measurement].
2. In the "Measurement condition" area, specify a value for each item.

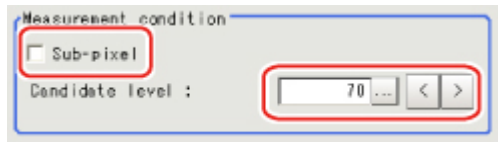

Setting item	Set value [factory default]	Description
Sub-pixel	<ul style="list-style-type: none"> · Checked · [Unchecked] 	When a check is placed at sub-pixel, the position information can be measured in units of sub-pixels. However, this requires more processing time.
Candidate level	0 to 100 [70]	Specify the threshold value with which to detect candidate points in a rough search. Specify a smaller value when model search results are unstable.

3. When the setting has been changed, tap [Measurement] in the Detail area to verify whether measurements can be made correctly.

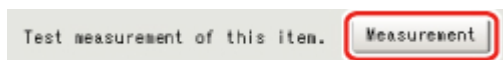

4. Set up the judgement condition.

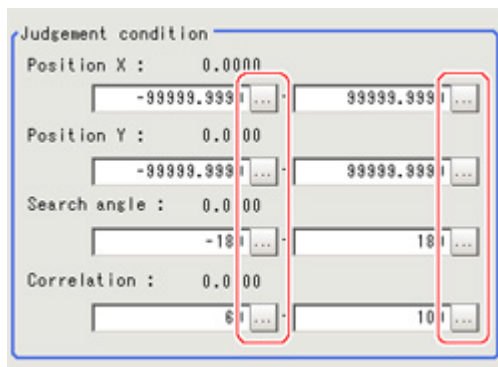

Note

- The values beside each item are measurement results of the displayed image. Take these values into consideration to determine the upper and lower limits.

Setting item	Set value	Description
Position X	-99999.9999 to 99999.9999	Specify the range of X-axis shifting that is judged to be OK.
Position Y	-99999.9999 to 99999.9999	Specify the range of Y-axis shifting that is judged to be OK.
Search angle	-180 to 180	Specify the range of angles that are judged to be OK.

Correlation	0 to 100	Specify the range of correlation values that are judged to be OK. However, when the correlation value of the measurement result is 0, the judgement result will be NG regardless of the lower limit setting.
-------------	----------	--

Output Parameters (Classification)

Specify how to treat the coordinates to be output to the external device as measurement results. This item can be changed if necessary. Normally, the factory default value will be used.

Important

- After setting up the measurement parameters, changing the output parameters will cause measurement results to vary accordingly. If the output parameters have been changed, re-specify the measurement, too.

- Tap [Output parameter] in the Item Tab area.
- Specify each of the following items.

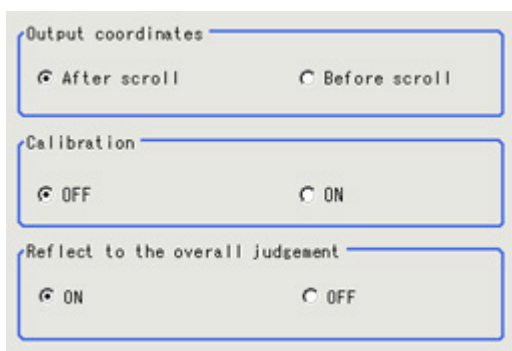

Setting item	Set value [factory default]	Description
Output Coordinates	<ul style="list-style-type: none"> [After scroll] Before scroll 	As measurement results, select whether to output coordinate values to external devices before or after the position deflection correction is applied.
Calibration	<ul style="list-style-type: none"> [OFF] ON 	Select whether to reflect the calibration in the values output to the external device as measurement results. ON: Output the coordinates converted into actual dimensions. OFF: Output the camera coordinate values.
Reflect to overall judgement	<ul style="list-style-type: none"> [ON] OFF 	Enables choosing whether or not the judgement result of this processing unit is reflected in the scene overall judgement.

Key Points for Test Measurement and Adjustment (Classification)

The following content is displayed in the "Detail result" area as text.

Displayed items	Description
Judge	Judgement result
Index	Index No. of the biggest correlation
Model number	Model No. of the biggest correlation
Correlation	Correlation with the model
Position X	X coordinate of the position where the model is detected

Position Y	Y coordinate of the position where the model is detected
Angle	Angle of the position where the model is detected

Key Points for Adjustment

Select the adjustment method referring to the following points.

When the measurement results are unstable

Searching other positions

Parameter to be adjusted	Remedy
Model parameter	Specify a larger value for the "Preciseness"
	If the measurement results are unstable only when "Rotation" is selected, specify a smaller value for the "Skipping angle".
	When "Rotation" is selected, if the model shape is complex, uncheck the "Smart mode" option.
	If the image has low contrast or blurred edges, set the "Search mode" to "CR".
	If the model image consists of detailed figures, specify a larger value for "Stab."
Measurement	If the precision is low, place a check at "Sub-pixel".
	If images that should be judged OK vary greatly, specify a smaller value for "Candidate level".
	If the model image is small and unstable, specify a smaller value for the "Reduction".

The judgement is NG (insufficient memory)

Parameter to be adjusted	Remedy
Region setting	Make the search region as small as possible.
Model parameter	Bring "Stab." close to the factory default value.
	Bring the "Skipping angle" close to the factory default value.
	Specify a smaller value for "Prec.".

When the processing speed is slow

Parameter to be adjusted	Remedy
Region setting	Make the search region as small as possible.
Model	Make the area to register as the model as small as possible.
Model parameter	If the model image is a simple figure or a large figure, specify a smaller value for "Stab." If lowering stability does not speed up processing, it is likely that many candidates have been detected. Raise the "Candidate level" in [Measurement parameter].
	When "Rotation" is selected and the model image is a simple figure, specify a larger value for "Skipping angle".
	When "Rotation" is selected and the model image is a simple figure, place a check at "Smart mode".
	If the position precision is high, specify a smaller value for "Preciseness".
	If the rotation angle range is large, set the "Search mode" to "PT".

Measurement	If images that should be judged OK vary little, specify a larger value for "Candidate level".
	If the position precision is high, uncheck "Sub-pixel".

Measurement Results for Which Output Is Possible (Classification)

The following values can be output using processing items related to results output. It is also possible to reference measurement values from expressions and other processing units.

Measurement items	Character string	Description
Judgement	JG	Judgement result
Index	IN	Index No. with the highest correlation value
Model No.	NO	Model No. with the highest correlation value
Correlation value	CR	Correlation with the model
Measurement position X	X	X coordinate of the position where the model is detected
Measurement position Y	Y	Y coordinate of the position where the model is detected
Measurement angle	TH	Angle of the position where the model is detected
Reference position X	SX	Reference coordinate X of the registered model
Reference position Y	SY	Reference coordinate Y of the registered model
Detection point RX	RX	X coordinate of the registered model
Detection point RY	RY	Y coordinate of the registered model

Edge Position

This processing item detects the position of the measurement object by using the change in color within the measurement region.

Used in the Following Case

- To calculate edge coordinates of measurement objects

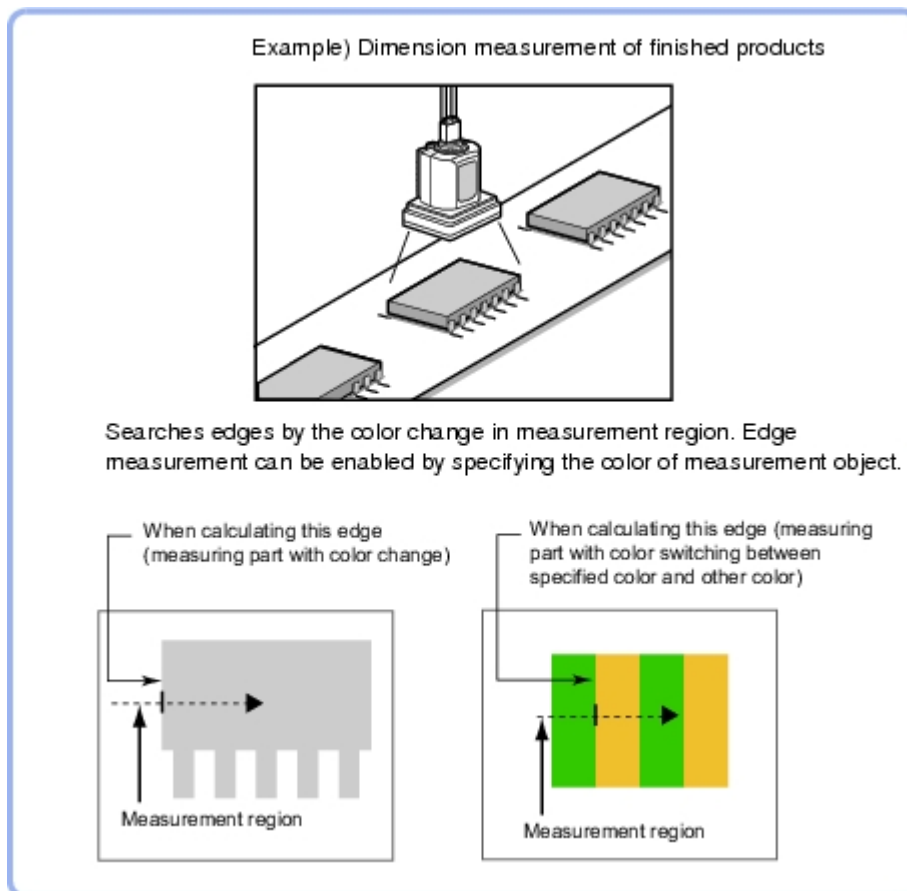

- To find the width of a measurement object
Using a Expression, the width of a measurement object can be calculated from the difference between two edge positions.

Note

- Edge processing basic concepts
Reference: ▶ See "User's Manual", "Edge Detection Measurement" (p.333)

Settings Flow (Edge Position)

Set the edge position with the following steps.

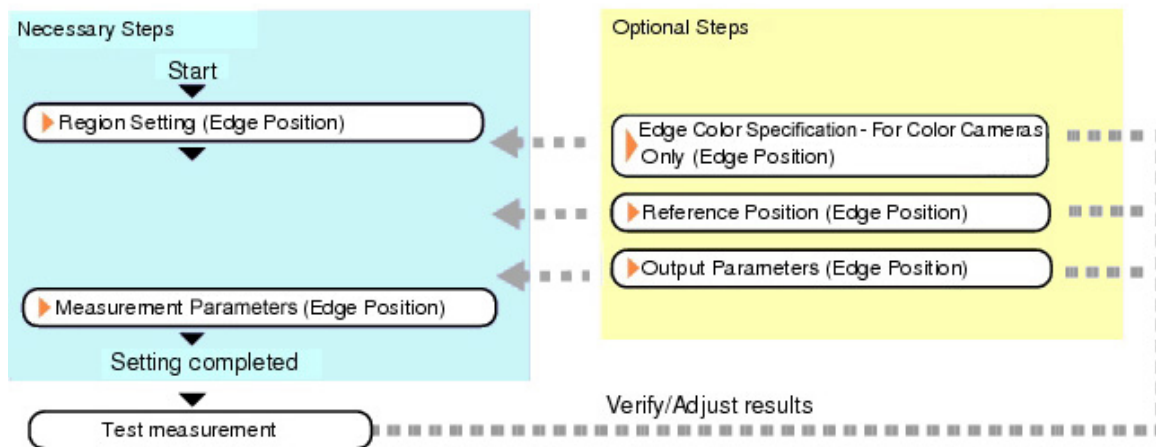

List of Edge Position Items

Item name	Description
Region setting	This item is used to set up the measurement area. Reference: ▶ Region Setting (Edge Position) (p.121)
Edge color (for color cameras only)	If the color of the edges to be detected is decided, specify the color. Reference: ▶ Edge Color Specification - For Color Cameras Only (Edge Position) (p.123)
Ref. position	The edge position is registered as the reference when the region is set.Change as necessary. Reference: ▶ Reference Position (Edge Position) (p.124)
Measurement	This item specifies the judgement condition for measurement results. Measurement parameter can be changed as needed to address unstable measurement results. The displayed items depend on whether your camera is a color or monochrome camera.Normally, the factory default value will be used. Reference: ▶ Measurement Parameters (Edge Position) (p.125)
Output parameter	This item can be changed if necessary.Normally, the factory default value may be used. Select the measurement result coordinates and set how to handle the coordinates. Reference: ▶ Output Parameters (Edge Position) (p.128)

Region Setting (Edge Position)

This item is used to set up the measurement area.

Use a straight line (arrow), circumference, or arc to specify a measurement region for [Edge position].

Note

- The edge is scanned from the start point of the area toward the end point. When setting up the measurement region, pay attention to the detection direction of the edge.

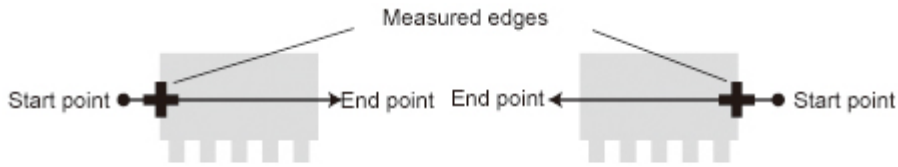

Drawing the line from left to right and from right to left will lead to different measured edges.

- Measurement cannot be performed if there is no edge within the measurement region. When determining the size and position of the measurement region, take into account the movement range of the measurement object.

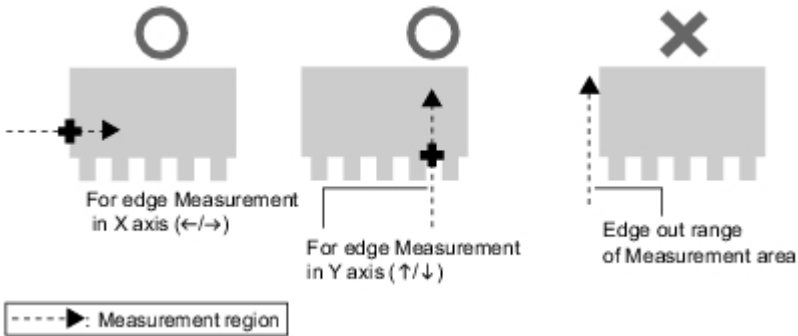

- In the Item Tab area, tap [Region setting].
- Use the Drawing tools to specify the measurement region.

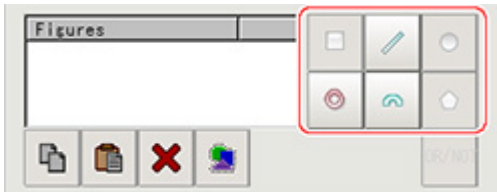

- In the figure setting area, tap [OK]. The measurement region is registered and displayed in the Image Display area.

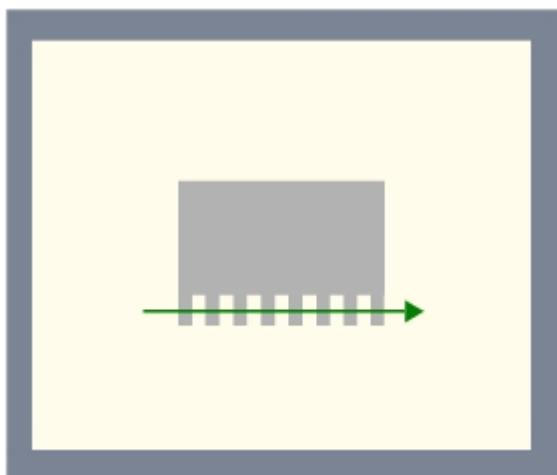

Note

- Use the zoom function if the measurement region is too small to identify the direction of the arrow. Reference: ▶ "Using the Zoom Function" in the "User's Manual" (p.347)

- When a circumference or arc is selected as the registered figure, select the edge search direction.
If a check is placed at the "Circle/Arc with width counterclockwise" option, the edge is searched counterclockwise. If this option is unchecked, the edge is searched clockwise.

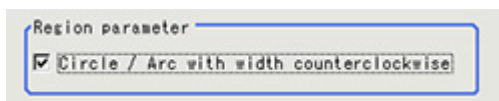

Edge Color Specification - For Color Cameras Only (Edge Position)

This item selects the color of the edges to be detected.
If the target color changes, this setting is not necessary. If the color is not specified, positions in the measurement region where the color changes drastically are detected as an edge.

- In the Item Tab area, tap [Edge color].
- Place a check at "Edge color specification" in the "Color setting" area.

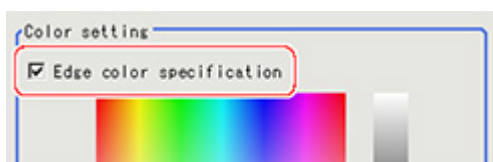

- This item selects the color to be detected as edges.

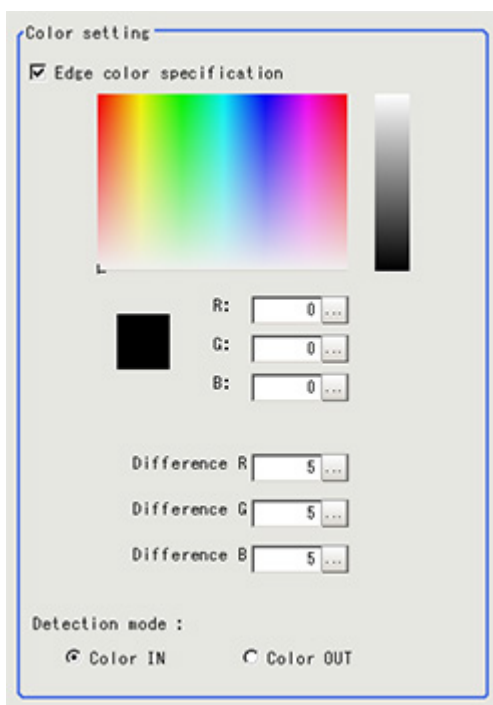

Setting methods	Description
Image Display area	Specify a region on the image that includes the target color. The average color of the specified region is registered.
Color chart	Tap the reference color on the color chart to specify it. The RGB values for the specified color are displayed at the bottom.

R, G, B	The color to be detected is set with the RGB values.
Difference R, G, B	This sets the allowable color difference for detecting the edge, using the specified color as the reference. The larger the difference values, the larger the color range that is used to detect the edge.
Detection mode	<p>Color IN: The position where a color other than the specified color changes to the specified color is detected as the edge. Color OUT: The position where the specified color changes to a color other than the specified color is detected as the edge.</p> <p>Start point ● —————> End point</p> <p>For "Color IN" edge measurement mode</p> <p>Start point ● —————> End point</p> <p>For "Color OUT" edge measurement mode</p>

Reference Position (Edge Position)

When the measurement region is set, this position is automatically set at the same time as the reference position. This item can be used to change the reference position to any desired position.

Note

Reference position usage method: [Measuring the distance from a specific position](#)

- Positional deviation can be inspected by calculating the difference between the reference position and the measured position with an expression.

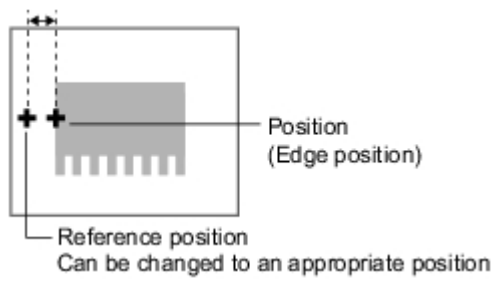

After changing the reference position to any desired position, changing the measurement region will automatically change it back to the default position.

- In the Item Tab area, tap [Ref. position].
 In the Image Display area, the current reference position will be displayed as the crosshair cursor.

2. Tap the position to be set as the reference position.

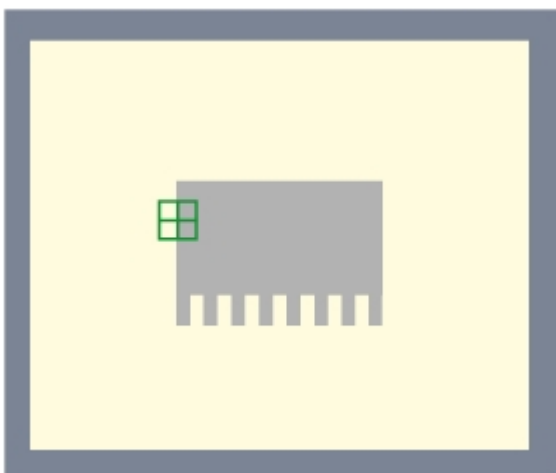

3. If necessary, finely adjust with numeric input and the arrow buttons.
To remeasure on the displayed image and set the reference position, tap [Measure ref.].

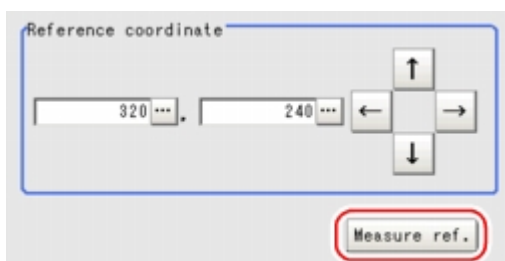

Measurement Parameters (Edge Position)

This item specifies the judgement condition for measurement results. Measurement parameter can be changed as needed to address unstable measurement results.

1. In the Item Tab area, tap [Measurement].
The edge profile of the measurement region is displayed as a graph in the Image Display area.

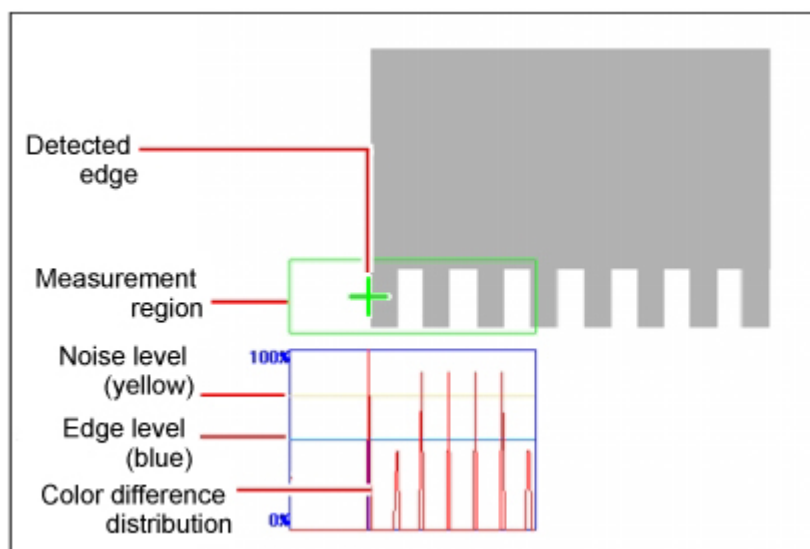

Note

- When the region is a circumference or arc, you can display the graph enlarged in the vertical direction. Place a check at "Zoom" and tap the button to adjust.



- If necessary, specify a value for each item in the "Measurement condition" area.
For color cameras:

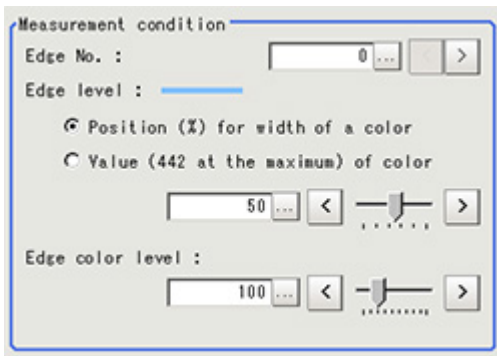

Setting item	Set value [factory default]	Description
Edge No.	0 to 99 [0]	Specify the edge number used to extract edges. Edge numbers are assigned to detected edges starting from 0 and going on in the direction from the start point (the arrow point) to the end point (the direction of arrow) in the selected area.
Edge level	<ul style="list-style-type: none"> Position (%) for width of a color 0 to 100 [50] Value of color 0 to 442 [20] 	Select a color difference level with which the edge is detected. Reference: ▶ See "User's Manual", "Edge Detection Measurement" (p.333)
Edge color level	0 to 442 [100]	This emphasis level can be specified only if the edge color to detect is specified.

For monochrome cameras:

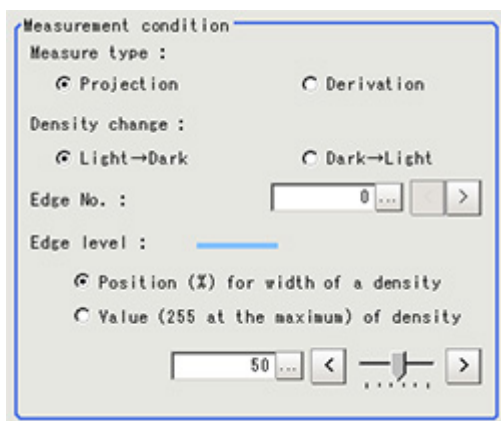

Setting item	Set value [factory default]	Description
Density change	[Light → Dark] Dark → Light	Select whether a black-to-white change or a white-to-black change should be recognized as a density change in the specified region.
Measure type	[Projection] Derivation	As the measurement type, specify either projection or derivation. Reference: ▶ See "User's Manual", "Edge Detection Method" (p.333)
Edge No.	0 to 99 [0]	Specify the edge number used to extract edges. Edge numbers are assigned to detected edges starting from 0 and going on in the direction from the start point (the arrow point) to the end point (the direction of arrow) in the selected area.
Edge level	<ul style="list-style-type: none"> Position (%) for width of a density 0 to 100 [50] Value of density 0 to 255 [20] 	Select the density change level to be detected as edges. Reference: ▶ See "User's Manual", "Edge Detection Measurement" (p.333)

3. If necessary, set each item in the "Noise removal" area.

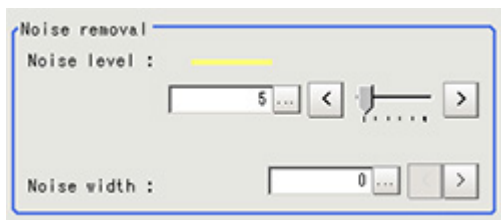

Setting item	Set value [factory default]	Description
Noise level	For color cameras: 0 to 442 [5] For monochrome cameras: 0 to 255 [5]	When edges are incorrectly detected due to noise, increase this value. Reference: ▶ See "User's Manual", "Noise level" (p.335)
Noise width	0 to 9999 [0]	Set the width for judging noise. When detection is affected by noise, increase this value. Reference: ▶ See "User's Manual", "Noise width" (p.336)

- When the setting has been changed, tap [Measurement] in the Detail area to verify whether measurements can be made correctly.



- Set up the judgement condition.

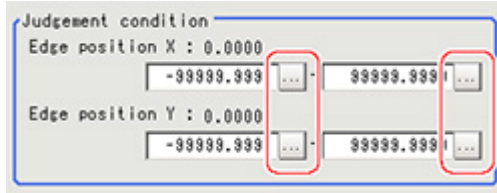

Note

- The values beside each item are measurement results of the displayed image. Take these values into consideration to determine the upper and lower limits.

Setting item	Set value	Description
Edge position X	-99999.9999 to 99999.9999	Specify the range of X-axis shifting that is judged to be OK.
Edge position Y	-99999.9999 to 99999.9999	Specify the range of Y-axis shifting that is judged to be OK.

Output Parameters (Edge Position)

Specify how to treat the coordinates to be output to the external device as measurement results. This item can be changed if necessary. Normally, the factory default value will be used.

Important

- After setting up the measurement parameters, changing the output parameters will cause measurement results to vary accordingly. If the output parameters have been changed, re-specify the measurement, too.

- Tap [Output parameter] in the Item Tab area.
- Specify each of the following items.

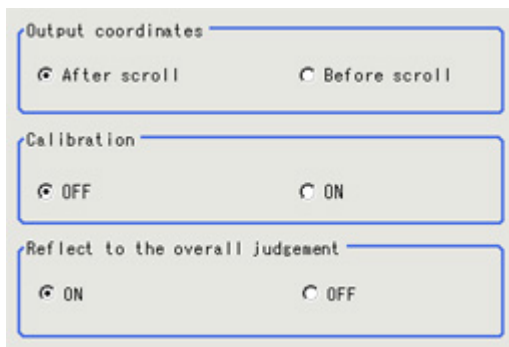

Setting item	Set value [factory default]	Description
Output Coordinates	<ul style="list-style-type: none"> · [After scroll] · Berofe scroll 	As measurement results, select whether to output coordinate values to external devices before or after the position deflection correction is applied.
Calibration	<ul style="list-style-type: none"> · [OFF] · ON 	Select whether to reflect the calibration in the values output to the external device as measurement results. ON: Output the coordinates converted into actual dimensions. OFF: Output the camera coordinate values.
Reflect to overall judgement	<ul style="list-style-type: none"> · [ON] · OFF 	Enables choosing whether or not the judgement results of this processing unit is reflected in the scene overall judgement.

Key Points for Test Measurement and Adjustment (Edge Position)

The following content is displayed in the "Detail result" area as text.

Displayed items	Description
Judge	Judgement result
Edge position X	X coordinate of the measured edge position
Edge position Y	Y coordinate of the measured edge position

Key Points for Adjustment

Select the adjustment method referring to the following points.

When the measurement results are unstable

Parameter to be adjusted	Remedy
Measurement	If the color of the edges to be detected is decided, specify the color with [Edge color].If results are not stable even with the color specified, specify a larger value for the color variance range.
	If noise is detected as an edge, specify larger values for "Noise level" and "Noise width".

Measurement Results for Which Output Is Possible (Edge Position)

The following values can be output using processing items related to results output.It is also possible to reference measurement values from expressions and other processing units.

Measurement items	Character string	Description
Judgement	JG	Judgement result
Edge position X	X	X coordinate of the measured edge position
Edge position Y	Y	Y coordinate of the measured edge position
Reference coordinate X	SX	Reference
Reference coordinate Y	SY	Reference

Edge Pitch

Finds and counts the edges by measuring the color change within the measurement region.

Used in the Following Case

- When calculating number of pins of IC or connectors

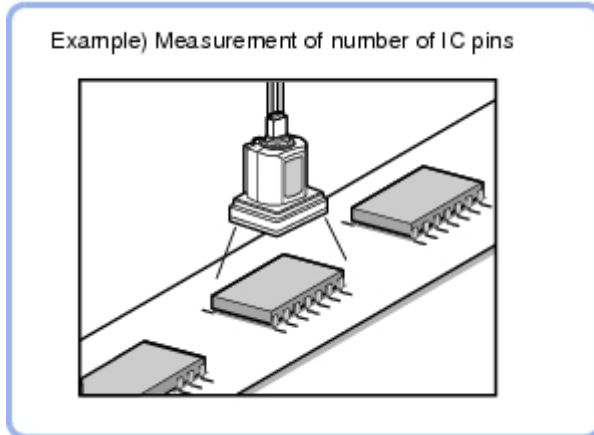

- To calculate the pin width and the distance (pitch) between mid-points between two pins

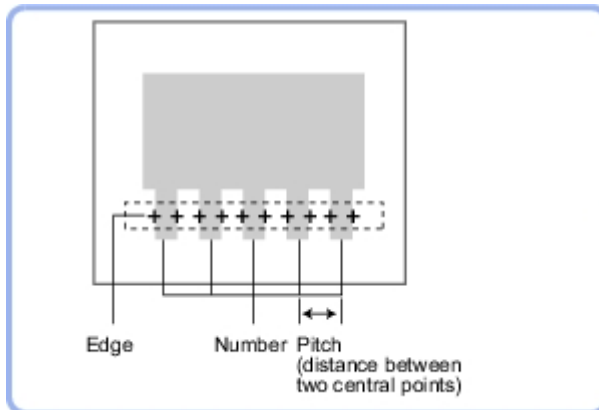

Note

- Edge image measurement processing mechanism
Reference: ▶ See "User's Manual", "Edge Detection Measurement" (p.333)

Settings Flow (Edge Pitch)

Set the Edge Pitch with the following steps.

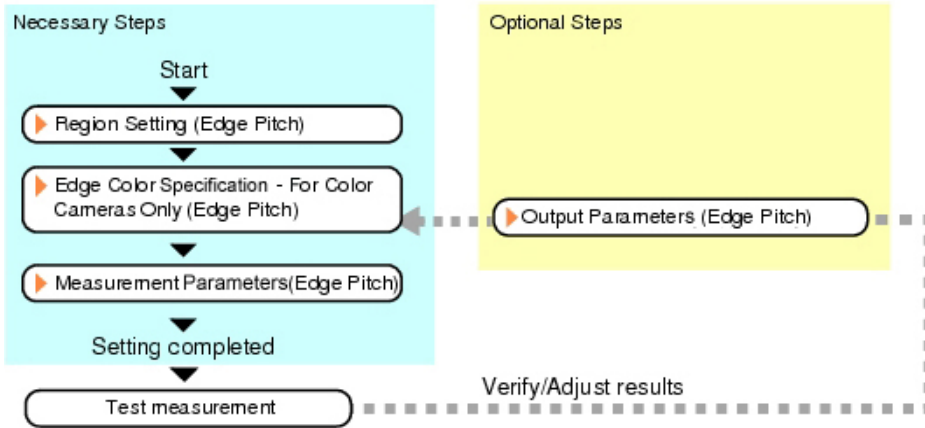

Item List for Edge Pitch

Item name	Description
Region setting	This item is used to set up the measurement area. Reference: ▶ Region Setting (Edge Pitch) (p.131)
Edge color (for color cameras only)	This item selects the color information for the edges to be detected. Reference: ▶ Edge Color Specification - For Color Cameras Only (Edge Pitch) (p.132)
Measurement	This item specifies the judgement condition for measurement results. Measurement parameter can be changed as needed to address unstable measurement results. Specify the pitch and width for counting edges. The displayed items depend on whether your camera is a color or monochrome camera. Normally, the factory default value will be used. Reference: ▶ Measurement Parameters (Edge Pitch) (p.133)
Output parameter	This item can be changed if necessary. Normally, the factory default value may be used. Select the measurement result coordinates and set how to handle the coordinates. Reference: ▶ Output Parameters (Edge Pitch) (p.135)

Region Setting (Edge Pitch)

This item is used to set up the measurement area.

Use a straight line, circumference, or arc to specify a measurement region for [Edge Pitch].

Note

- When setting up a measurement region, please include all the edges to be detected.

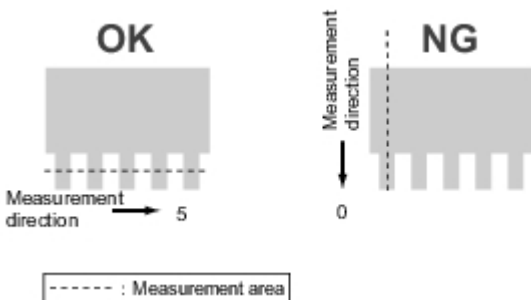

1. In the Item Tab area, tap [Region setting].
2. Use the Drawing tools to specify the measurement region.

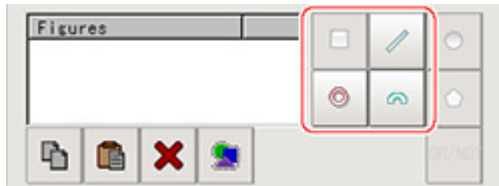

3. In the figure setting area, tap [OK].
The measurement region is registered and displayed in the Image Display area.

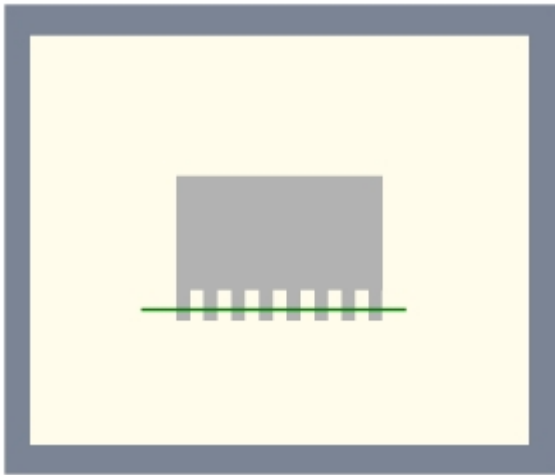

Edge Color Specification - For Color Cameras Only (Edge Pitch)

Specify the target color to be counted.

1. In the Item Tab area, tap [Edge color].
2. Specify the target color for the edges to be counted (used as the reference color for edge detecting).

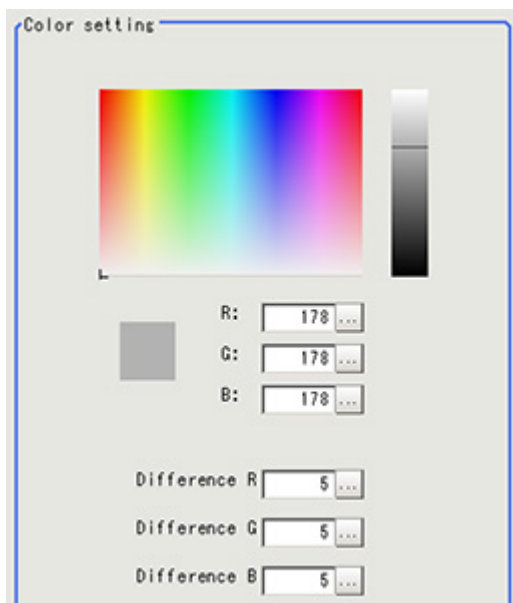

Setting methods	Description
Image Display area	Specify a region on the image that includes the target color. The average color of the specified region is registered.
Color chart	Tap the color on the color chart to specify it. The RGB values for the specified color are displayed at the bottom.
R, G, B	The color to be detected is set with the RGB values.
Difference R, G, B	This sets the allowable color difference for detecting the edge, using the specified color as the reference. The larger the difference values, the larger the color range that is used to detect the edge.

Measurement Parameters (Edge Pitch)

This item specifies the judgement condition for measurement results. Also specify the range for positions to be judged as OK.

1. In the Item Tab area, tap [Measurement].

The edge profile of the measurement region (straight line) is displayed in the Image Display area.

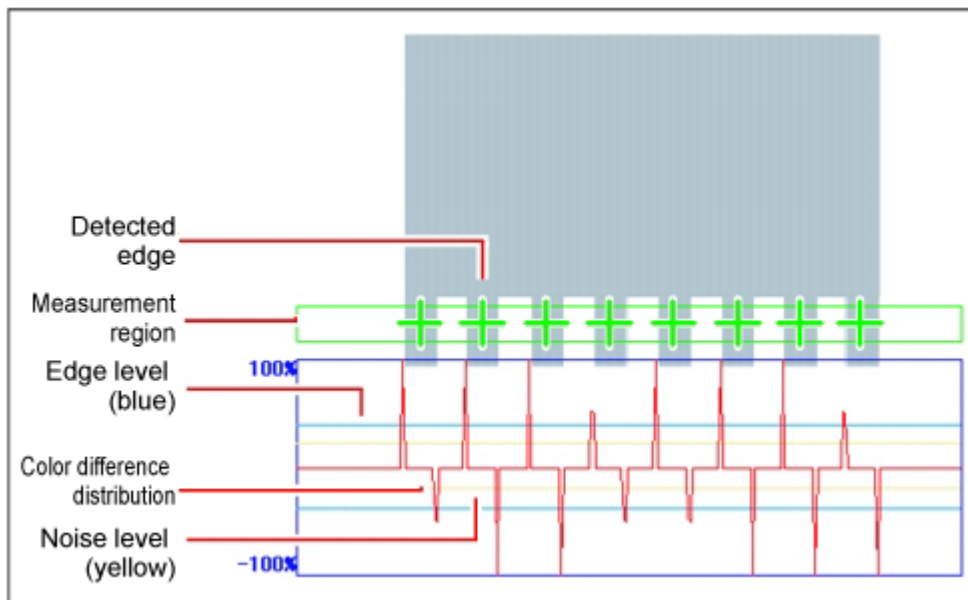

2. If necessary, specify a value for each item in the "Measurement condition" area.

For color cameras:



Setting item	Set value [factory default]	Description
Edge level	0 to 100 [50]	Specify a color changing level with which the edge is detected. When the measurement result is lower than the actual number of edges, specify a smaller value for the edge level. On the other hand, when the measurement result is higher than the actual number of edges, specify a larger value for the edge level. Reference: ▶ See "User's Manual", "Edge level" (p.334)
Edge color level	0 to 442 [100]	Set the emphasis level for the edge color specified with [Edge color].

For monochrome cameras:

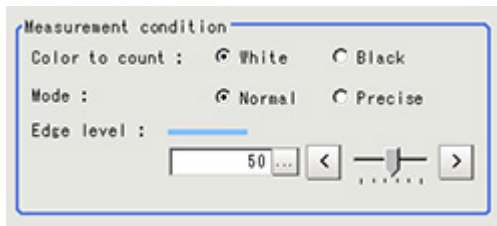

Important

- Up to 1000 edges can be measured, but only a maximum of 256 can be displayed on the screen.

Setting item	Set value [factory default]	Description
Color to count	· [White] · Black	Select an edge color to be measured.
Mode	· [Normal] · Precise	If the pin width or gap is less than 2 pixels, select precise.
Edge level	0 to 100 [50]	Specify the density change level to be detected as edges. When the measurement result is lower than the actual number, specify a smaller value for the edge level (or the minimum level). On the other hand, when the measurement result is higher than the actual number, specify a larger value for the edge level (or the minimum level). Reference: ▶ See "User's Manual", "Edge level" (p.334)

3. If necessary, set each item in the "Noise removal" area.



Setting item	Set value [factory default]	Description
Noise level	0 to 442 [5]	When detection is affected by noise, increase this value. Reference: ▶ See "User's Manual", "Noise level" (p.335)
Noise width	0 to 9999 [0]	Set the width for judging noise. When detection is affected by noise, increase this value. Reference: ▶ See "User's Manual", "Noise width" (p.336)

- When the setting has been changed, tap [Measurement] in the Detail area to verify whether measurements can be made correctly.



- Set up the judgement condition.

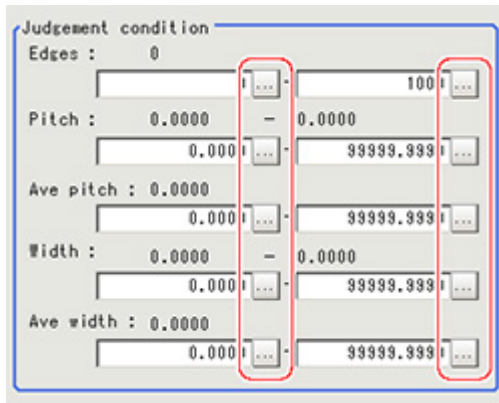

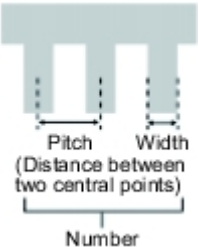
Setting item	Set value	Description
Edges	0 to 999	Specify a range to be judged as OK. 
Pitch	0 to 99999.9999	
Ave pitch	0 to 99999.9999	
Width	0 to 99999.9999	
Average width	0 to 99999.9999	

Output Parameters (Edge Pitch)

Specify how to treat the coordinates to be output to the external device as measurement results. This item can be changed if necessary. Normally, the factory default value will be used.

Important

- After setting up the measurement parameters, changing the output parameters will cause measurement results to vary accordingly. If the output parameters have been changed, re-specify the measurement, too.

- Tap [Output parameter] in the Item Tab area.

2. Specify each of the following items.

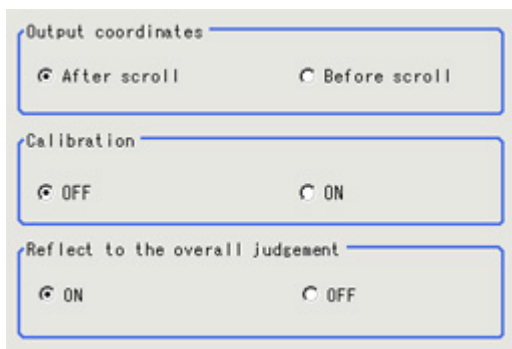

Setting item	Set value [factory default]	Description
Output Coordinates	<ul style="list-style-type: none"> · [After scroll] · Before scroll 	As measurement results, select whether to output coordinate values to external devices before or after the position deflection correction is applied.
Calibration	<ul style="list-style-type: none"> · [OFF] · ON 	Select whether to reflect the calibration in the values output to the external device as measurement results. ON: Output the coordinates converted into actual dimensions. OFF: Output the camera coordinate values.
Reflect to overall judgement	<ul style="list-style-type: none"> · [ON] · OFF 	Enables choosing whether or not the judgement results of this processing unit is reflected in the scene overall judgement.

Key Points for Test Measurement and Adjustment (Edge Pitch)

The following content is displayed in the "Detail result" area as text.

Displayed items	Description
Judge	Judgement result
Number of edges	Number of edges
Average pitch	Average edge pitch
Max. pitch	Edge maximum pitch
Min. pitch	Edge minimum pitch
Average width	Average edge width
Max. width	Edge maximum width
Min. width	Edge minimum width

Key Points for Adjustment

Select the adjustment method referring to the following points.

Parameter to be adjusted	Remedy
Edge color	If edges cannot be detected properly, specify a larger value for the color variance range.
Measurement	If noise is detected as an edge, specify a larger value for "Noise level" and "Noise width".

Edge level	When the measurement result is lower than the actual number of edges, specify a smaller value for the "Edge level". On the other hand, when the measurement result is higher than the actual number of edges, specify a larger value for the "Edge level".
------------	--

Measurement Results for Which Output Is Possible (Edge Pitch)

The following values can be output using processing items related to results output. It is also possible to reference measurement values from expressions and other processing units.

Measurement items	Character string	Description
Judgement	JG	Judgement result
Number of Edge Pins	N	Number of detected edges
Average pitch	P	Average pitch of detected edges
Max. pitch	PH	Maximum pitch of detected edges
Min. pitch	PL	Minimum pitch of detected edges
Average width	W	Average width of detected edges
Max. width	WH	Maximum width of detected edges
Min. width	WL	Minimum width of detected edges

Scan Edge Position

This processing item detects the position of the measurement object by using the change in color within the measurement region. By dividing the measurement region, the following effects can be expected compared to ordinary edge position measurement.

- Detailed information, such as the closest point or furthest point from the measurement start point, can be calculated.
- The inclination or degree of unevenness of the measured object can be calculated.

Used in the Following Case

- To calculate multiple edge positions of the measurement object from statistical data

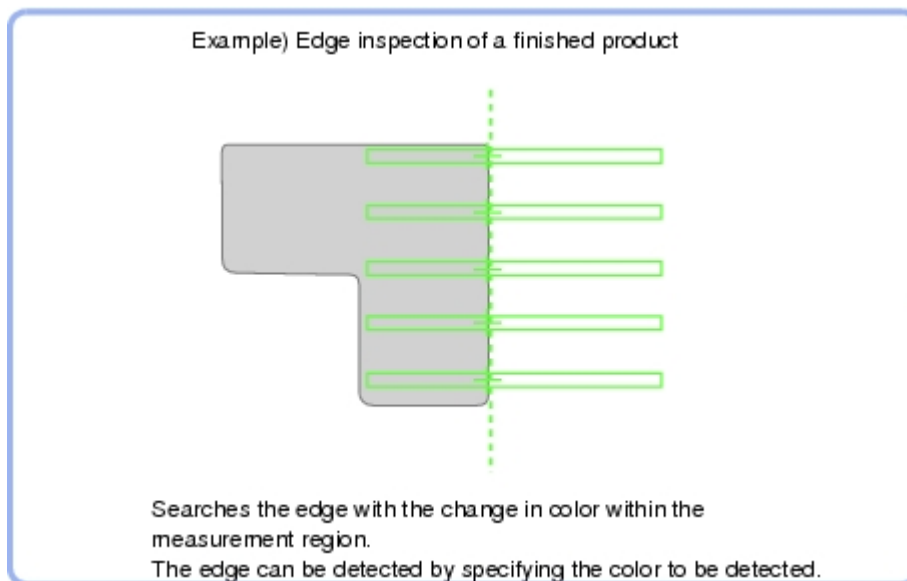

Note

- Edge image measurement processing mechanism
Reference: ▶ See "User's Manual", "Edge Detection Measurement" (p.333)

Settings Flow (Scan Edge Position)

Set the scan edge position with the following steps.

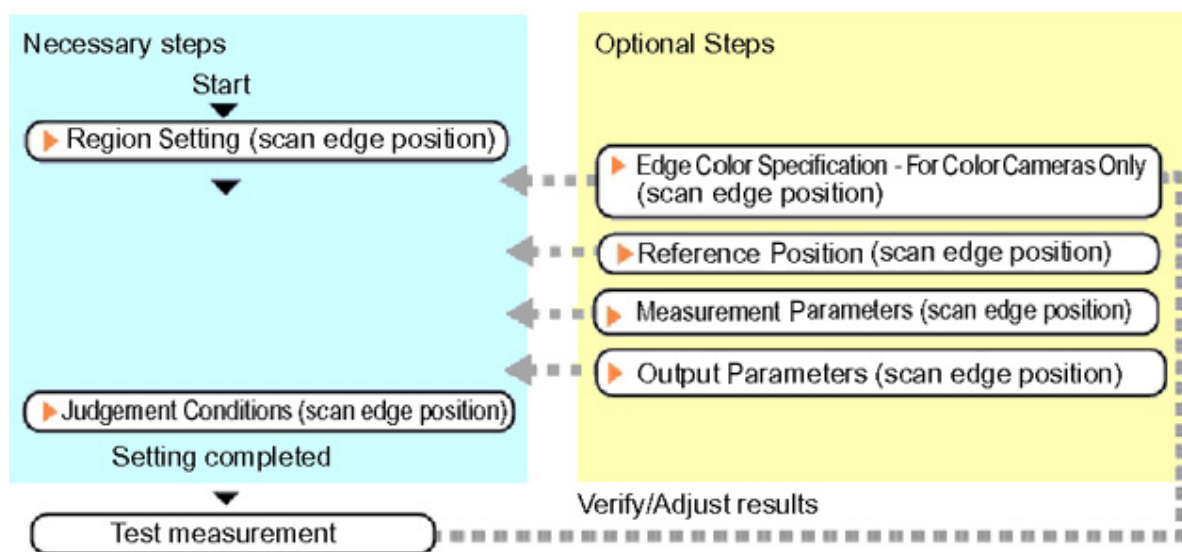

Item List for Scan Edge Position

Item name	Description
Region setting	This item is used to set up the measurement area. Reference: ▶ Region Setting (Scan Edge Position) (p.139)
Edge color (for color cameras only)	If the color of the edges to be detected is decided, specify the information for the edge color to be detected. Reference: ▶ Edge Color Specification - For Color Cameras Only (Scan Edge Position) (p.141)
Ref. position	This item can be changed if necessary. The edge position measured once is registered when the region is set. Reference: ▶ Reference Position (Scan Edge Position) (p.142)
Measurement	This item changes the measurement parameter as necessary when the measurement result is unstable. The displayed items depend on whether your camera is a color or monochrome camera. Normally, the factory default value will be used. Reference: ▶ Measurement Parameters (Scan Edge Position) (p.143)
Judgement	This item specifies the judgement condition for measurement results. Reference: ▶ Judgment Conditions (Scan Edge Position) (p.146)
Output parameter	This item can be changed if necessary. Normally, the factory default value may be used. Select the measurement result coordinates and set how to handle the coordinates. Reference: ▶ Output Parameters (Scan Edge Position) (p.148)

Region Setting (Scan Edge Position)

This item is used to set up the measurement area.

Specify the measurement region for [Scan Edge Position] by using wide straight lines.

1. In the Item Tab area, tap [Region setting].

- Use the Drawing tools to specify the measurement region.

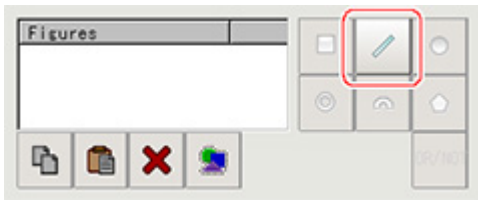

To align with the measurement area and change the number of measurement points, uncheck this.



- In the figure setting area, tap [OK].
The measurement region is registered and displayed in the Image Display area.

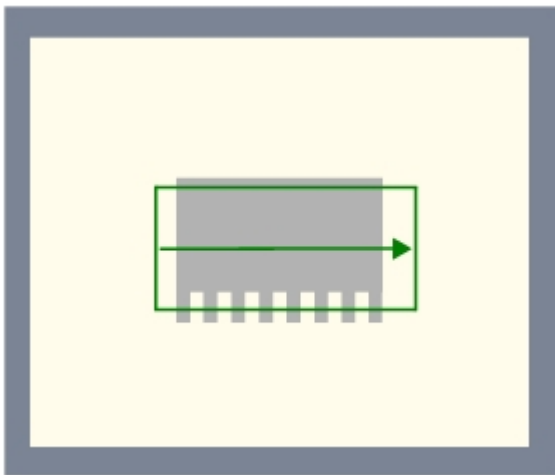

- Set the measurement point and the filter size for the region.

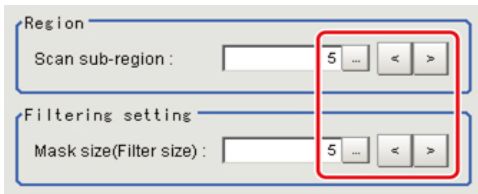

Setting item	Set value [factory default]	Description
Scan sub-region	1 to 100 [5]	Set the measurement point for the region.
Mask size (Filter size)	1 to 200 [5]	Set the filter size when smoothing the measurement point vicinity. When 5 is set, smoothing is processed for a total of 11 points: the measurement point and the 5 pixels before and after it.

5. The region is divided equally.

Division of Scan Area

The scan region, when the number of measurement points is 1

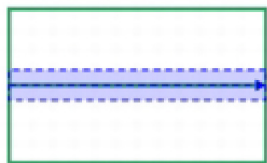

The scan region, when the number of measurement points is 3

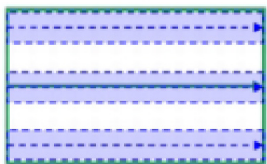

The scan region, when the number of measurement points is 2



The scan region, when the number of measurement points is 4

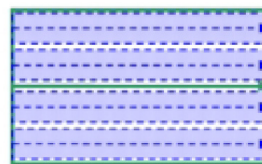

Note

- You can specify enable/disable for each edge measurement number. Tapping edge measurement points displays the following screen.

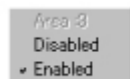

Edge Color Specification - For Color Cameras Only (Scan Edge Position)

This item selects the color of the edges to be detected.

If the target color changes, this setting is not necessary. If the color is not specified, positions in the measurement region where the color changes drastically are detected as an edge.

- In the Item Tab area, tap [Edge color].
- Place a check at "Edge color specification" in the "Color setting" area.

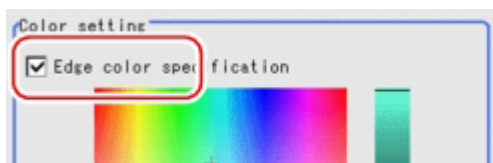

3. This item selects the color to be detected as edges.

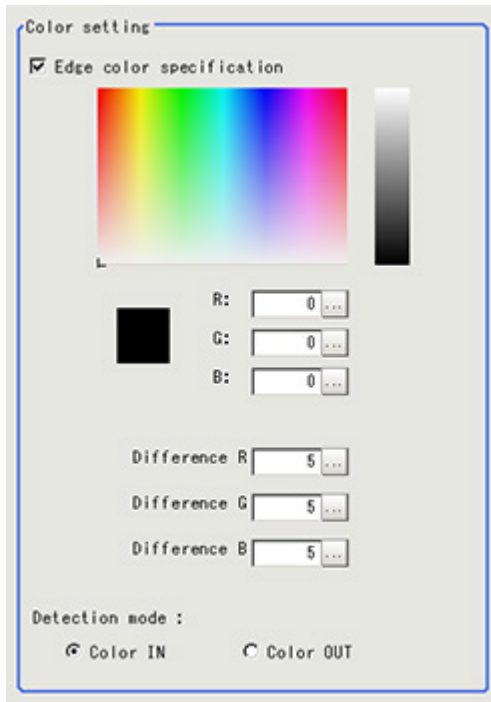

Setting methods	Description
Image Display area	Specify a region on the image that includes the target color. The average color of the specified region is registered.
Color chart	Tap the reference color on the color chart to specify it. The RGB values for the specified color are displayed at the bottom.
R, G, B	The color to be detected is set with the RGB values.
Difference R, G, B	This sets the allowable color difference for detecting the edge, using the specified color as the reference. The larger the difference values, the larger the color range that is used to detect the edge.
Detection mode	<p>Color IN: The position where a color other than the specified color changes to the specified color is detected as the edge.</p> <p>Color OUT: The position where the specified color changes to a color other than the specified color is detected as the edge.</p> <div style="display: flex; justify-content: space-around; align-items: center;"> <div style="text-align: center;"> <p>For "Color IN" edge measurement mode</p> </div> <div style="text-align: center;"> <p>For "Color OUT" edge measurement mode</p> </div> </div>

Reference Position (Scan Edge Position)

When the measurement region is set, this position is automatically set at the same time as the reference position. This item can be used to change the reference position to any desired position.

Note**Reference position usage method: Measuring the distance from a specific position**

- Positional deviation can be inspected by calculating the difference between the reference position and the measured position with an expression.

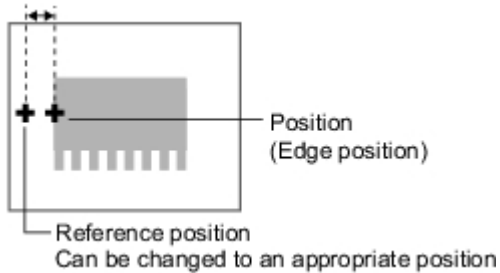

After changing the reference position to any desired position, changing the measurement region will automatically change it back to the default position.

- In the Item Tab area, tap [Ref. position].
In the Image Display area, the current reference position will be displayed as the crosshair cursor.
- Tap the position to be set as the reference position.

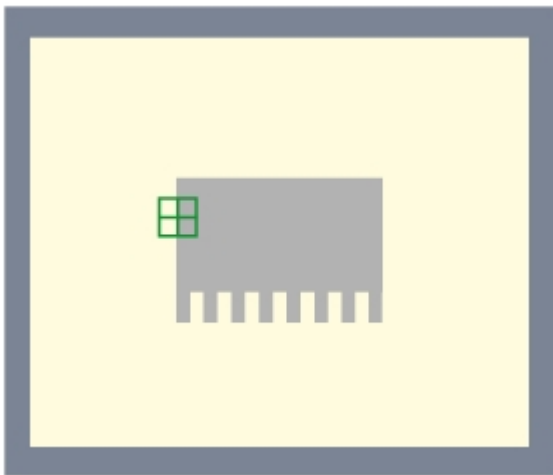

- If necessary, finely adjust with numeric input and the arrow buttons.
To remeasure on the displayed image and set the reference position, tap [Measure ref.].

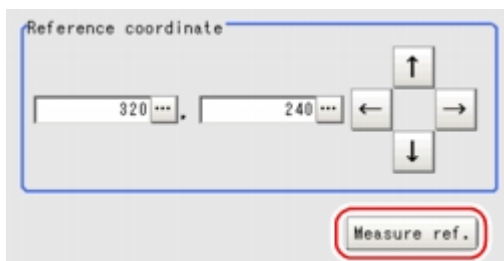

Measurement Parameters (Scan Edge Position)

Measurement parameters can be changed as needed to address unstable measurement results. Normally, the factory default value will be used.

After changing a setting, check whether measurement can be done properly by performing an actual measurement.

1. In the Item Tab area, tap [Measurement].
The edge profile of the measurement region is displayed as a graph in the Image Display area.

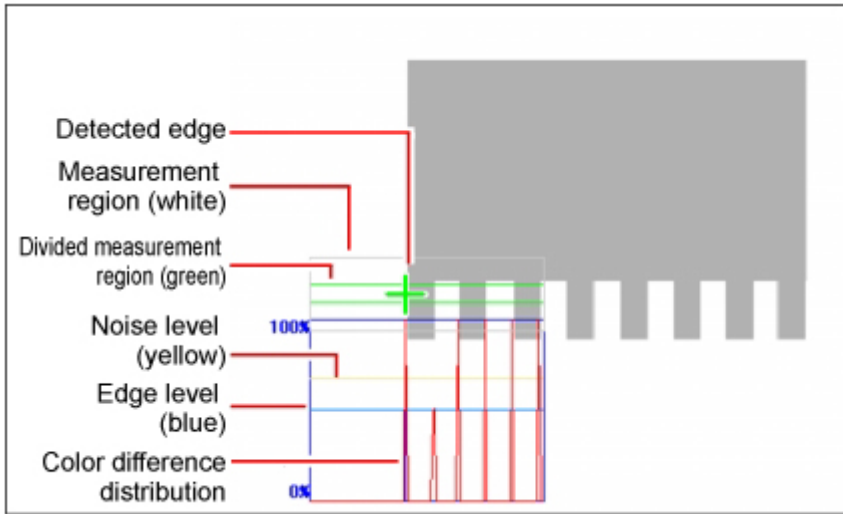

2. Set the value of each item in the "Display position" area.

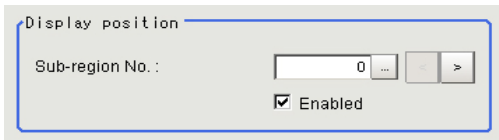

Setting item	Set value [factory default]	Description
Sub-region No.	[0] to 99	Specify the edge measurement number for which the edge profile is displayed.
Enabled	<ul style="list-style-type: none"> • [Checked] • Unchecked 	Specify enable/disable for the displayed edge measurement number. When disabled (unchecked) is specified, that edge measurement number is not measured.

3. Set the value of each item in the "Measurement" area.
For color cameras:

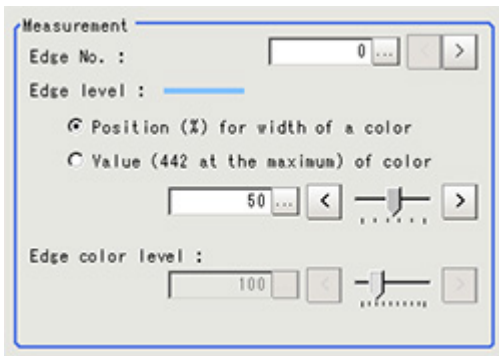

Setting item	Set value [factory default]	Description
Edge No.	0 to 99 [0]	Specify the edge number used to extract edges. Edge numbers are assigned to detected edges starting from 0 and going on in the direction from the start point (the arrow point) to the end point (the direction of arrow) in the selected area.
Edge level	<ul style="list-style-type: none"> Position (%) for width of a color 0 to 100 [50] Value of color 0 to 442 [20] 	Select a color difference level with which the edge is detected. Reference: ▶ See "User's Manual", "Edge level" (p.334)
Edge color level	0 to 442 [100]	This emphasis level can be specified only if the edge color to detect is specified.

For monochrome cameras:

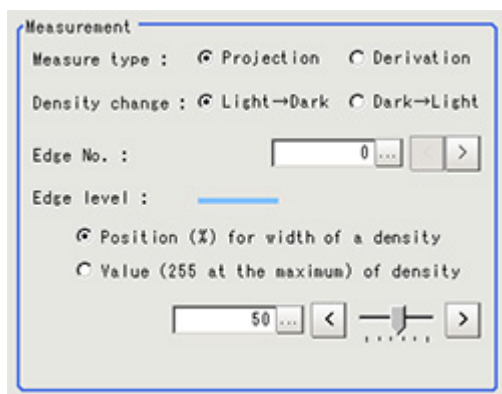

Setting item	Set value [factory default]	Description
Measure type	[Projection] Derivation	This sets the type of edge measurement. Reference: ▶ See "User's Manual", "Edge Detection Method" (p.333)
Density change	[Light → Dark] Dark → Light	Select whether a black-to-white change or a white-to-black change should be recognized as a density change in the specified region.
Edge No.	0 to 99 [0]	Specify the edge number used to extract edges. Edge numbers are assigned to detected edges starting from 0 and going on in the direction from the start point (the arrow point) to the end point (the direction of arrow) in the selected area.
Edge level	<ul style="list-style-type: none"> Position (%) for width of a density 0 to 100 [50] Value of density 0 to 255 [20] 	Select the density change level to be detected as edges. Reference: ▶ See "User's Manual", "Edge level" (p.334)

4. If necessary, set each item in the "Noise removal" area.

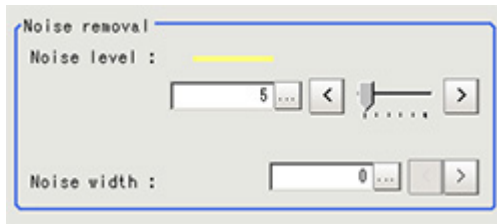

Setting item	Set value [factory default]	Description
Noise level	0 to 442 [5]	When detection is affected by noise, increase this value. Reference: ▶ See "User's Manual", "Noise level" (p.335)
Noise width	0 to 9999 [0]	Set the width for judging noise. When detection is affected by noise, increase this value. Reference: ▶ See "User's Manual", "Noise width" (p.336)

5. In the "Approximate line" area, specify the point to be used for the calculation of approximate lines.

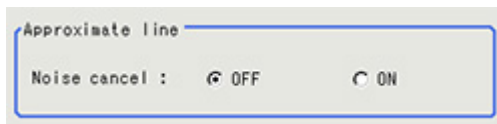

Setting item	Set value [factory default]	Description
Noise cancel	<ul style="list-style-type: none"> · ON · [OFF] 	When a check is placed at [ON], an approximate line is found by excluding the points with large deviation among the measured points.

Judgment Conditions (Scan Edge Position)

Specify the range to be judged as OK.

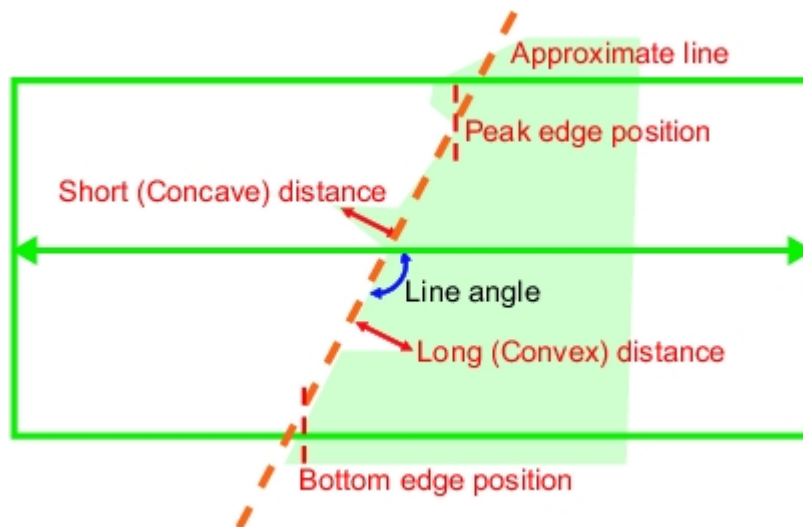

1. In the Item Tab area, tap [Judgement].
2. Set up the judgement condition.

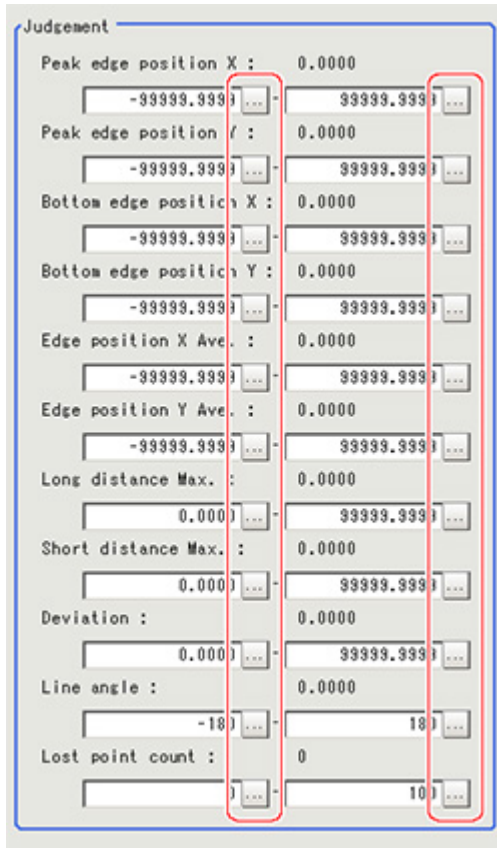

Note

- The values beside each item are measurement results of the displayed image. Take these values into consideration to determine the upper and lower limits.

Setting item	Set value	Description
Peak edge position X	-99999.9999 to 99999.9999	Specify the X-axis upper and lower limits of the peak edge position X judged to be OK.
Peak edge position Y	-99999.9999 to 99999.9999	Specify the Y-axis upper and lower limits of the peak edge position Y judged to be OK.
Bottom edge position X	-99999.9999 to 99999.9999	Specify the X-axis upper and lower limits of the bottom edge position X judged to be OK.
Bottom edge position Y	-99999.9999 to 99999.9999	Specify the Y-axis upper and lower limits of the bottom edge position Y judged to be OK.
Edge position X Ave.	-99999.9999 to 99999.9999	Specify the X-axis upper and lower limits of the average edge position judged to be OK.
Edge position Y Ave.	-99999.9999 to 99999.9999	Specify the Y-axis upper and lower limits of the average edge position judged to be OK.
Long distance Max.	0 to dist (X_MAX, Y_MAX)	Specify the upper and lower limits of the long distance maximum judged to be OK.

Long distance Min.	0 to dist (X_MAX, Y_MAX)	Specify the upper and lower limits of the long distance minimum judged to be OK.
Short distance Max.	0 to dist (X_MAX, Y_MAX)	Specify the upper and lower limits of the short distance maximum judged to be OK.
Short distance Min.	0 to dist (X_MAX, Y_MAX)	Specify the upper and lower limits of the short distance minimum judged to be OK.
Deviation	0 to dist (X_MAX, Y_MAX)	Specify the upper and lower limits of the deviation judged to be OK.
Line angle	-180 to 180	Specify the upper and lower limits of the line angle judged to be OK.
Lost point count	0 to 100	Specify the upper and lower limits of the lost point count judged to be OK.

* dist (X_MAX, Y_MAX) = sqrt (X_MAX*X_MAX+Y_MAX*Y_MAX)

Output Parameters (Scan Edge Position)

Specify how to treat the coordinates to be output to the external device as measurement results. This item can be changed if necessary. Normally, the factory default value will be used.

Important

- After setting up the measurement parameters, changing the output parameters will cause measurement results to vary accordingly. If the output parameters have been changed, re-specify the measurement, too.

- Tap [Output parameter] in the Item Tab area.
- Specify each of the following items.

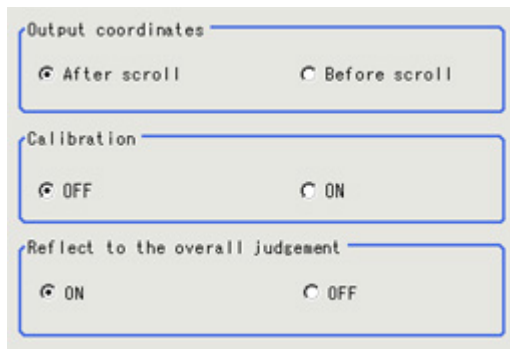

Setting item	Set value [factory default]	Description
Output Coordinates	<ul style="list-style-type: none"> [After scroll] Before scroll 	As measurement results, select whether to output coordinate values to external devices before or after the position deflection correction is applied.
Calibration	<ul style="list-style-type: none"> [OFF] ON 	Select whether to reflect the calibration in the values output to the external device as measurement results. ON: Output the coordinates converted into actual dimensions. OFF: Output the camera coordinate values.

Reflect to overall judgement	<ul style="list-style-type: none"> · [ON] · OFF 	Enables choosing whether or not the judgement results of this processing unit is reflected in the scene overall judgement.
------------------------------	---	--

Key Points for Test Measurement and Adjustment (Scan Edge Position)

In addition to the camera input image, the measured region, a graphic display of the measured results, and the edge position (the crosshair cursor) are also displayed as results in the Image Display area.

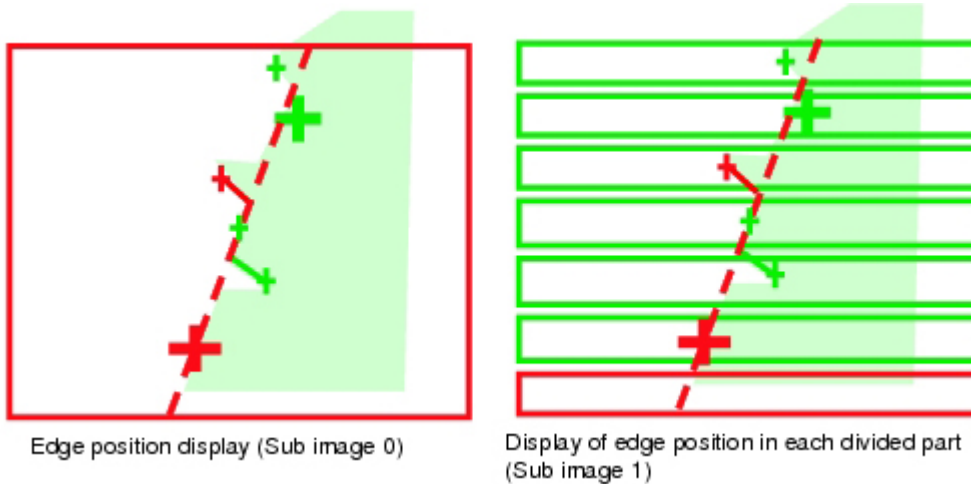

The following content is displayed in the "Detail result" area as text.

Displayed items	Description
Judge	Judgement result
Peak edge position X	X coordinate of the edge that is the furthest from the start point of the measurement region
Peak edge position Y	Y coordinate of the edge that is the furthest from the start point of the measurement region
Bottom edge position X	X coordinate of the edge that is the closest to the start point of the measurement region
Bottom edge position Y	Y coordinate of the edge that is the closest to the start point of the measurement region
Edge position X Ave.	The average of X coordinates of all the edges
Edge position Y Ave.	The average of Y coordinates of all the edges
Long distance Max.	The maximum distance between the approximate line and edge position (plus direction)
Short distance Max.	The minimum distance between the approximate line and the edge position (minus direction)
Deviation	Deviations in concavity and convexity (Value of the standard deviation for the distance of each edge point from the linear regression)
Line angle	The straight line's inclination against the measurement region does not include 180, which is displayed as -180. Output range -90° to 90°
Lost point count	Number of parts for which the detection of edges has failed

Key Points for Adjustment

Select the adjustment method referring to the following points.

When the measurement results are unstable

Parameter to be adjusted	Remedy
Measurement	If the color of the edges to be detected is decided, specify the color with [Edge color]. If results are not stable even with the color specified, specify a larger value for the color variance range.
	If noise is detected as an edge, specify larger values for "Noise level" and "Noise width".

Measurement Results for Which Output Is Possible (Scan Edge Position)

The following values can be output using processing items related to results output. It is also possible to reference measurement values from expressions and other processing units.

Measurement items	Character string	Description
Judgement	JG	Judgement result
Peak edge position X	PEAKX	X coordinate of the edge that is the furthest from the start point of the measurement region
Peak edge position Y	PEAKY	Y coordinate of the edge that is the furthest from the start point of the measurement region
Bottom edge position X	BOTTOMX	X coordinate of the edge that is the closest to the start point of the measurement region
Bottom edge position Y	BOTTOMY	Y coordinate of the edge that is the closest to the start point of the measurement region
Edge position X Ave.	X	The average of X coordinates of all the edges
Edge position Y Ave.	Y	The average of Y coordinates of all the edges
Reference position X	SX	X coordinate of the reference coordinates
Reference position Y	SY	Y coordinate of the reference coordinates
Long distance Max.	PMAXD	The maximum distance between the approximate line and edge position (plus direction)
Long distance Min.	PMIND	The minimum distance between the approximate line and the edge position (plus direction)
Short distance Max.	BMAXD	The maximum distance between the approximate line and the edge position (minus direction)
Short distance Min.	BMIND	The minimum distance between the approximate line and the edge position (minus direction)
Deviation	DEV	Deviations in concavity and convexity
Angle	TH	The straight line's inclination against the measurement region does not include 180, which is displayed as -180.
Lost point	LOST	Number of parts for which the detection of edges has failed
Line Param. A	A	A in the expression for the approximate line $AX + BY + C = 0$.
Line Param. B	B	B in the expression for the approximate line $AX + BY + C = 0$.

LineParam. C	C	C in the expression for the approximate line $AX + BY + C = 0$.
--------------	---	--

Scan Edge Width

This processing item detects the position of the measurement object by using the change in color within the measurement region. By dividing the measurement region, you can get the following values.

- Local width of the work
- Average width of the work

Used in the Following Case

- When getting several widths of a measurement object

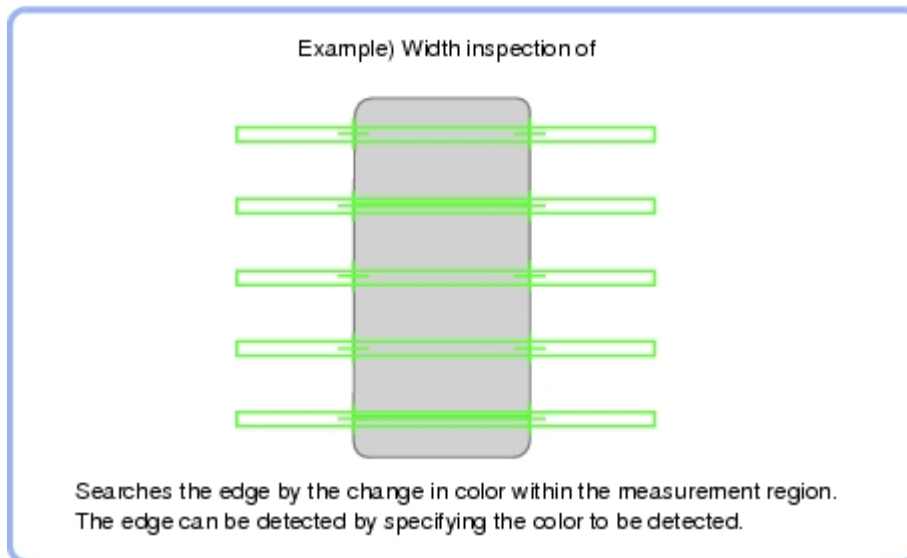

- To find the width of a measurement object
Using a Expression, the width of a measurement object can be calculated from the difference between two edge positions.

Note

- Edge image measurement processing mechanism
Reference: ▶ See "User's Manual", "Edge Detection Measurement" (p.333)

Settings Flow (Scan Edge Width)

Set the scan edge width with the following steps.

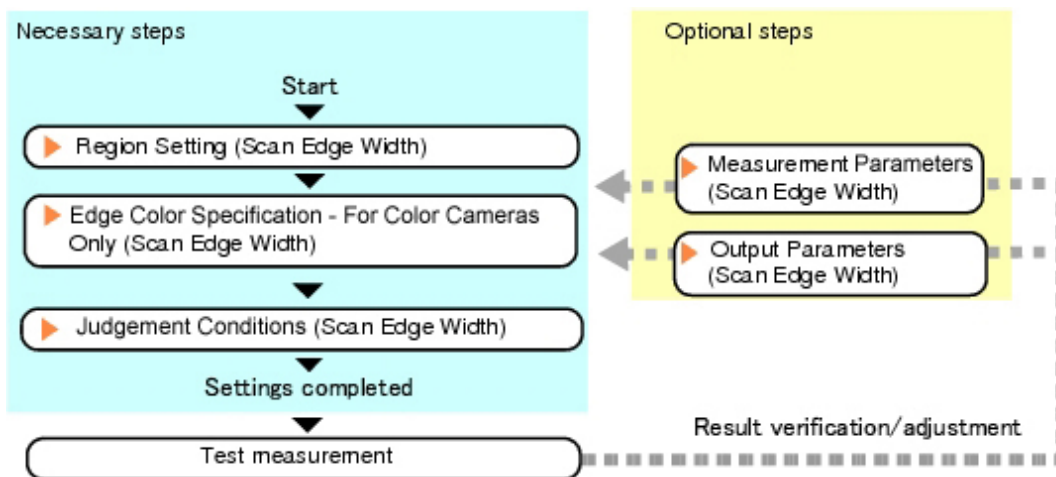

Item List for Scan Edge Width

Item name	Description
Region setting	This item is used to set up the measurement area. Reference: ▶ Region Setting (Scan Edge Width) (p.153)
Edge color (for color cameras only)	This item selects the color information for the edges to be detected. Reference: ▶ Edge Color Specification - For Color Cameras Only (Scan Edge Width) (p.155)
Measurement	This item changes the measurement parameter as necessary when the measurement result is unstable. The displayed items depend on whether your camera is a color or monochrome camera. Normally, the factory default value will be used. Reference: ▶ Measurement Parameters (Scan Edge Width) (p.156)
Judgement	This item specifies the judgement condition for measurement results. Reference: ▶ Judgement Conditions (Scan Edge Width) (p.159)
Output parameter	This item can be changed if necessary. Normally, the factory default value may be used. Select the measurement result coordinates and set how to handle the coordinates. Reference: ▶ Output Parameters (Scan Edge Width) (p.159)

Region Setting (Scan Edge Width)

This item is used to set up the measurement area.

Specify the measurement region of [Scan Edge Width] by using a wide line.

1. In the Item Tab area, tap [Region setting].
2. Use the Drawing tools to specify the measurement region.

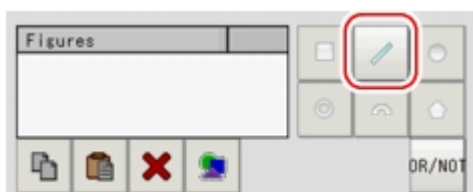

To align with the measurement area and change the number of measurement points, uncheck

this.

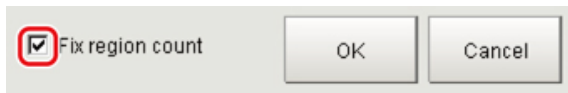

- In the figure setting area, tap [OK].
The measurement region is registered and displayed in the Image Display area.

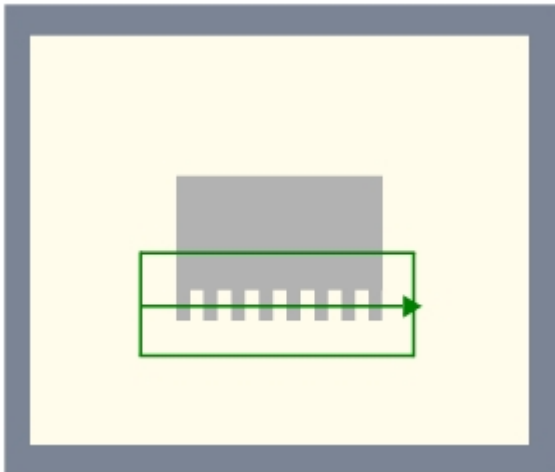

- Set the measurement point and the filter size for the region.

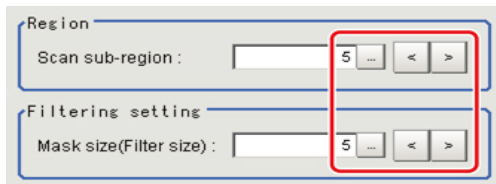

Setting item	Set value [factory default]	Description
Scan sub-region	1 to 100 [5]	Set the measurement point for the region.
Mask size (Filter size)	1 to 200 [5]	Set the filter size when smoothing the measurement point vicinity. When 5 is set, smoothing is processed for a total of 11 points: the measurement point and the 5 pixels before and after it.

5. The region is divided equally.

The scan region, when the number of measurement points is 1

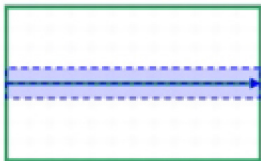

The scan region, when the number of measurement points is 2



The scan region, when the number of measurement points is 3

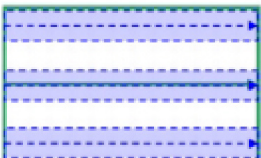

The scan region, when the number of measurement points is 4

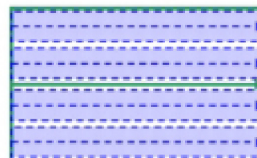

Note

- You can specify enable/disable for each edge measurement number. Tapping edge measurement points displays the following screen.

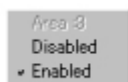

Edge Color Specification - For Color Cameras Only (Scan Edge Width)

This item selects the color of the edges to be detected.

If the target color changes, this setting is not necessary. If the color is not specified, positions in the measurement region where the color changes drastically are detected as an edge.

- In the Item Tab area, tap [Edge color].
- Place a check at "Edge color specification" in the "Color setting" area.

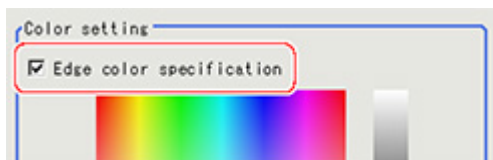

3. This item selects the color to be detected as edges.

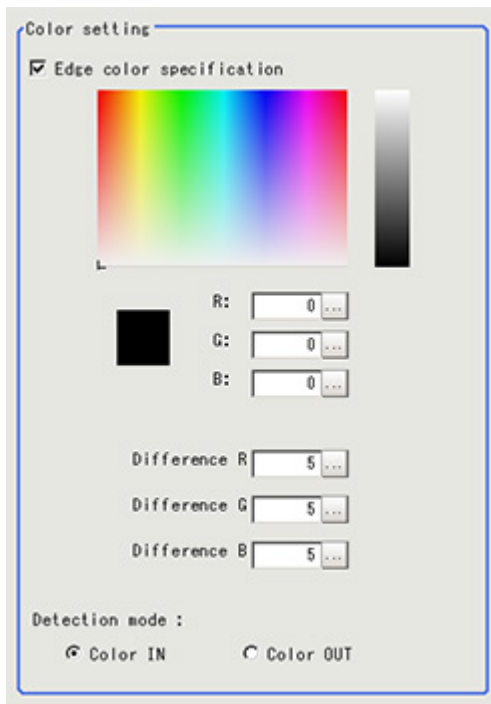

Setting methods	Description
Image Display area	Specify a region on the image that includes the target color. The average color of the specified region is registered.
Color chart	Tap the reference color on the color chart to specify it. The RGB values for the specified color are displayed at the bottom.
R, G, B	The color to be detected is set with the RGB values.
Difference R, G, B	This sets the allowable color difference for detecting the edge, using the specified color as the reference. The larger the difference values, the larger the color range that is used to detect the edge.
Detection mode	<p>Color IN: The position where a color other than the specified color changes to the specified color is detected as the edge.</p> <p>Color OUT: The position where the specified color changes to a color other than the specified color is detected as the edge.</p> <div style="display: flex; justify-content: space-around; align-items: center;"> <div style="text-align: center;"> <p>For "Color IN" edge measurement mode</p> </div> <div style="text-align: center;"> <p>For "Color OUT" edge measurement mode</p> </div> </div>

Measurement Parameters (Scan Edge Width)

Measurement parameters can be changed as needed to address unstable measurement results. Normally, the factory default value will be used.

After changing a setting, check whether measurement can be done properly by performing an actual measurement.

- In the Item Tab area, tap [Measurement].
The edge profile of the measurement region is displayed as a graph in the Image Display area.

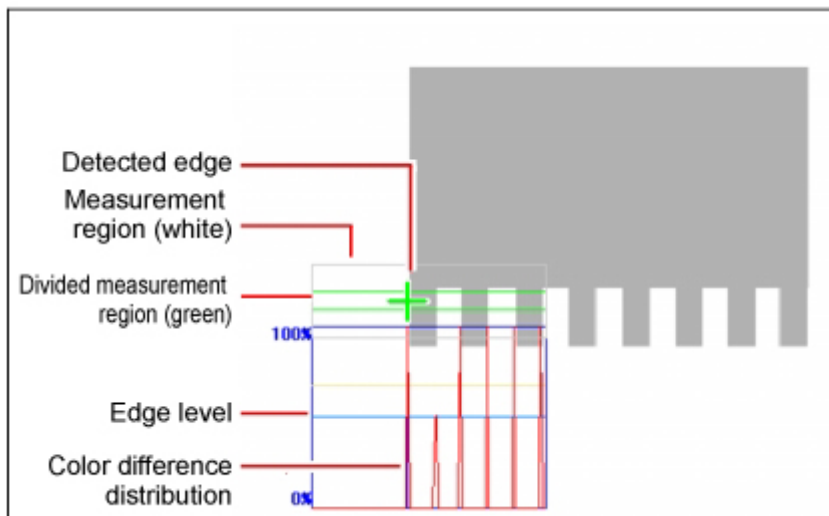

- Set the value of each item in the "Display position" area.

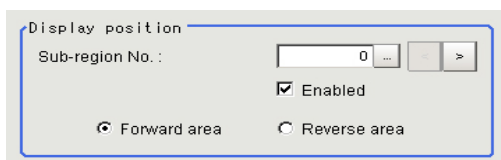

Setting item	Set value [factory default]	Description
Sub-region No.	[0] to 99	Specify the edge measurement number for which the edge profile is displayed.
Enabled	<ul style="list-style-type: none"> [Checked] [Unchecked] 	Specify enable/disable for the displayed edge measurement number. When disabled (unchecked) is specified, that edge measurement number is not measured.
	<ul style="list-style-type: none"> [Forward area] [Reverse area] 	Forward area: The edge is searched from the start point of the area toward the end point. Reverse area: The edge is searched from the end point of the area toward the start point.

- Set the value of each item in the "Measurement" area.
For color cameras:

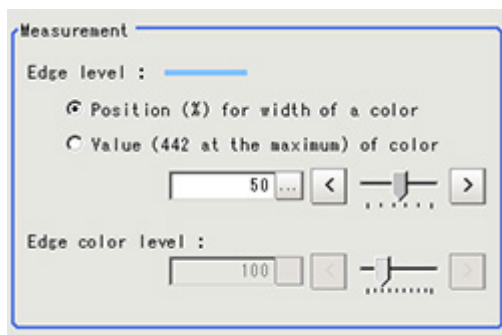

Setting item	Set value [factory default]	Description
Edge level	<ul style="list-style-type: none"> Position (%) for width of a color 0 to 100 [50] Value of color 0 to 442 [20] 	Select a color difference level with which the edge is detected. Reference: ▶ See "User's Manual", "Edge level" (p.334)
Edge color level	0 to 442 [100]	This emphasis level can be specified only if the edge color to detect is specified.

For monochrome cameras:

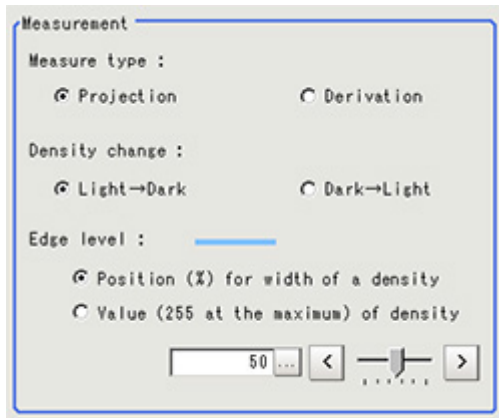

Setting item	Set value [factory default]	Description
Measure type	[Projection] Derivation	This sets the type of edge measurement.
Density change	[Light → Dark] Dark → Light	Select whether a black-to-white change or a white-to-black change should be recognized as a density change in the specified region.
Edge level	<ul style="list-style-type: none"> Position (%) for width of a density 0 to 100 [50] Value of density 0 to 255 [20] 	Select the density change level to be detected as edges. Reference: ▶ See "User's Manual", "Edge level" (p.334)

4. If necessary, set each item in the "Noise removal" area.

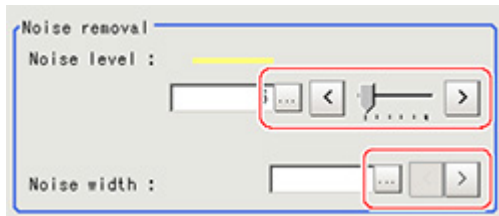

Setting item	Set value [factory default]	Description
Noise level	0 to 442 [5]	When detection is affected by noise, increase this value. Reference: ▶ See "User's Manual", "Noise level" (p.335)
Noise width	0 to 9999 [0]	Set the width for judging noise. When detection is affected by noise, increase this value. Reference: ▶ See "User's Manual", "Noise width" (p.336)

Judgement Conditions (Scan Edge Width)

Specify the range to be judged as OK.

1. In the Item Tab area tap [Judgement].
2. Set up the judgement condition.

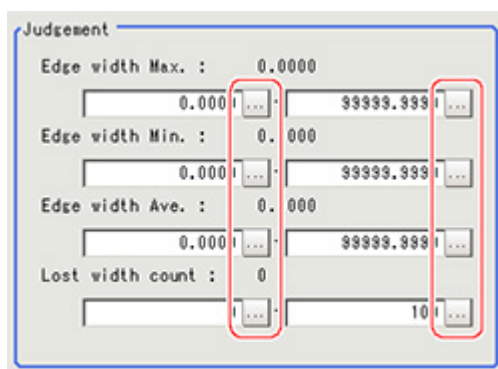

Note

- The values beside each item are measurement results of the displayed image. Take these values into consideration to determine the upper and lower limits.

Setting item	Set value	Description
Edge width Max.	0 to dist (X_MAX,Y_MAX)	Specify the upper and lower limits of the maximum width judged to be OK.
Edge width Min.	0 to dist (X_MAX,Y_MAX)	Specify the upper and lower limits of the minimum width judged to be OK.
Edge width Ave.	0 to dist (X_MAX,Y_MAX)	Specify the upper and lower limits of the average width judged to be OK.
Lost width count	0 to 100	Specify the upper and lower limits of the lost width count judged to be OK.

* $\text{dist}(X_MAX, Y_MAX) = \sqrt{X_MAX * X_MAX + Y_MAX * Y_MAX}$

Output Parameters (Scan Edge Width)

Specify how to treat the coordinates to be output to the external device as measurement results. This item can be changed if necessary. Normally, the factory default value will be used.

Important

- After setting up the measurement parameters, changing the output parameters will cause measurement results to vary accordingly. If the output parameters have been changed, re-specify the measurement, too.

1. Tap [Output parameter] in the Item Tab area.
2. Specify each of the following items.

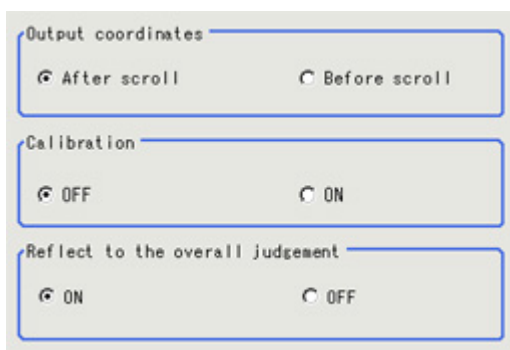

Setting item	Set value [factory default]	Description
Output Coordinates	<ul style="list-style-type: none"> · [After scroll] · Before scroll 	As measurement results, select whether to output coordinate values to external devices before or after the position deflection correction is applied.
Calibration	<ul style="list-style-type: none"> · [OFF] · ON 	Select whether to reflect the calibration in the values output to the external device as measurement results. ON: Output the coordinates converted into actual dimensions. OFF: Output the camera coordinate values.
Reflect to overall judgement	<ul style="list-style-type: none"> · [ON] · OFF 	Enables choosing whether or not the judgement results of this processing unit is reflected in the scene overall judgement.

Key Points for Test Measurement and Adjustment (Scan Edge Width)

The following contents can be displayed as text in the "Detail result" area.

Displayed items	Description
Judge	Judgement result
Edge width Max.	The maximum value of edge width
Edge width Min.	The minimum value of edge width
Edge width Ave.	The average value of all the edge width
Lost width count	The number of the scanned areas for which the detection of width failed

Key Points for Adjustment

Select the adjustment method referring to the following points.

When the measurement results are unstable

Parameter to be adjusted	Remedy
Measurement	If the color of the edges to be detected is decided, specify the color with [Edge color].If results are not stable even with the color specified, specify a larger value for the color variance range.
	If noise is detected as an edge, specify larger values for "Noise level" and "Noise width".

Measurement Results for Which Output Is Possible (Scan Edge Width)

The following values can be output using processing items related to results output.It is also possible to reference measurement values from expressions and other processing units.

Measurement items	Character string	Description
Judgement	JG	Judgement result
Edge width Max.	MAXW	The maximum value of edge width
Edge width Min.	MINW	The minimum value of edge width
Edge width Ave.	AVEW	The average value of all the edge width
Lostwidth	LOST	The number of the scanned areas for which the detection of width failed

Color Data

Inspect by finding the average color of the measurement region and using its difference from the registered reference color and the color variation in the measurement area. Alternatively, you can only detect the color tone while neglect the effect of image brightness.

For monochrome cameras, examination is performed by measuring the difference between the average density of the measurement region and the registered reference density (density average), and the density deviation in the measurement region (density deviation).

Used in the Following Case

- When measuring the presence of measurement objects

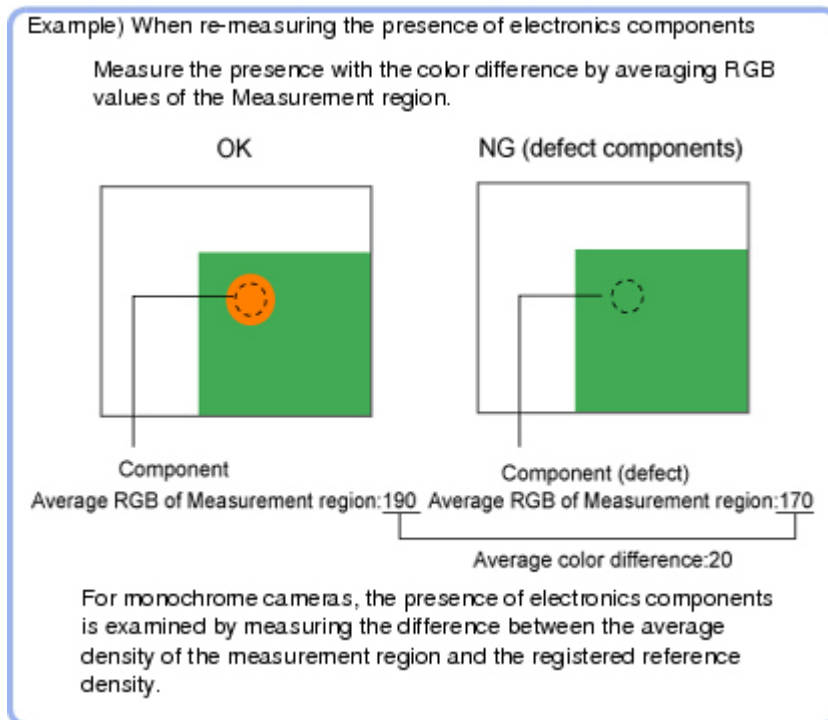

Settings Flow (Color Data)

Set the color data with the following steps.

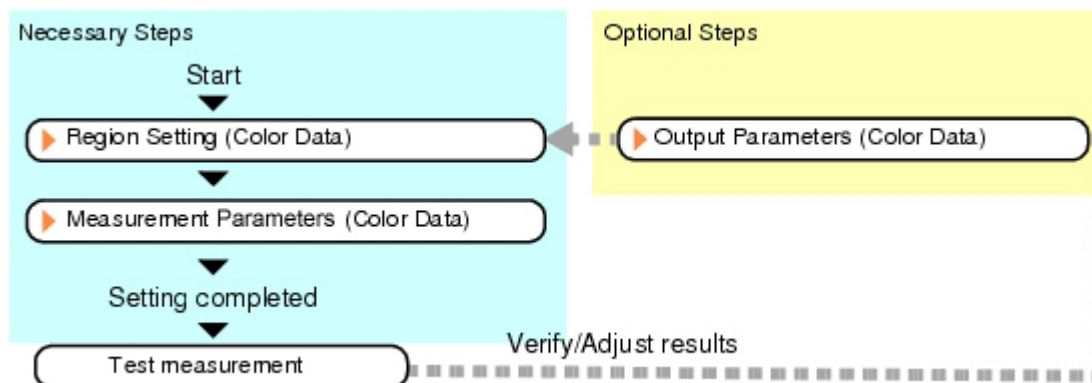

List of Color Data Items

Item name	Description
Region setting	This item is used to set up the measurement area. While the input image can be measured as a whole, a quick and reliable measurement can be performed by set up the measured range. Reference: ▶ Region Setting (Color Data) (p.163)
Measurement	This item specifies the judgement condition for measurement results. <ul style="list-style-type: none"> For color cameras: Set the average color (RGB) value and deviation and set what the maximum difference is for judging the object to be OK. For monochrome cameras: Specify the average density value and deviation and set what the maximum difference is for judging the object to be OK. Measurement parameter can be changed as needed to address unstable measurement results or to increase the processing speed. Normally, the factory default value will be used. Reference: ▶ Measurement Parameters (Color Data) (p.164)
Output parameter	This item can be changed if necessary. Normally, the factory default value will be used. Specify whether to reflect the judgement result to the overall judgement of the scene. Reference: ▶ Output Parameters (Color Data) (p.166)

Region Setting (Color Data)

This item is used to set up the measurement area. It is possible to measure the entire input image, but restricting the range enables accurate measurement in a short period of time. A measurement region for [Color Data] can be specified as a rectangle, circle (ellipse), circumference, or polygon.

Note

- Up to 8 graphs can be used together to draw the measured region. Complex areas can be drawn through image integration or by removing unnecessary sections from the measurement region.

- In the Item Tab area, tap [Region setting].
- Select a button in the drawing tools.

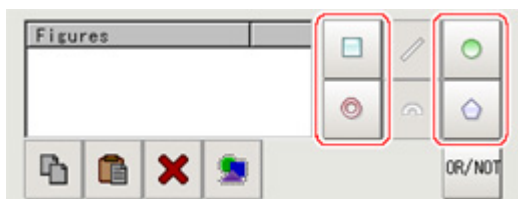

- In the figure setting area, specify a region to be measured.
- In the figure setting area, tap [OK].
The measurement region is registered and displayed in the Image Display area.

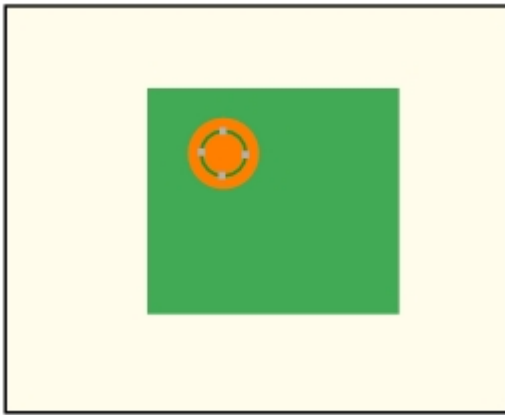

5. To register a color in the region as a reference color, place a check at "Auto update reference color".

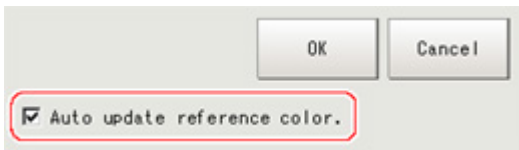

Note

- When a check is placed at "Auto update reference color", the average color within the region is automatically registered as the reference color when the region is registered. Each time the region is updated, the reference color is updated.
To hold the reference color constant, uncheck this option and register the reference color with the measurement parameters.
Reference: ▶ Measurement Parameters (Color Data) (p.164)

Measurement Parameters (Color Data)

Set the reference color and judgement conditions.

For Color Cameras:

1. In the Item Tab area, tap [Measurement].
2. If necessary, check the "Normalization" option in the "Correction condition" area.
Normally, the factory default value will be used. After changing a setting, check whether measurement can be done properly by performing an actual measurement.



Setting item	Set value [factory default]	Description
Normalization	<ul style="list-style-type: none"> · Checked · [Unchecked] 	<p>Specify whether to normalize the brightness in calculating the color difference.</p> <p>When checked, the result is not affected by the total brightness and only the color tone can be detected.</p>

- In the "Reference color" area, specify the reference color.
This operation is not needed when there is a check at "Auto update reference color" when the region is registered.

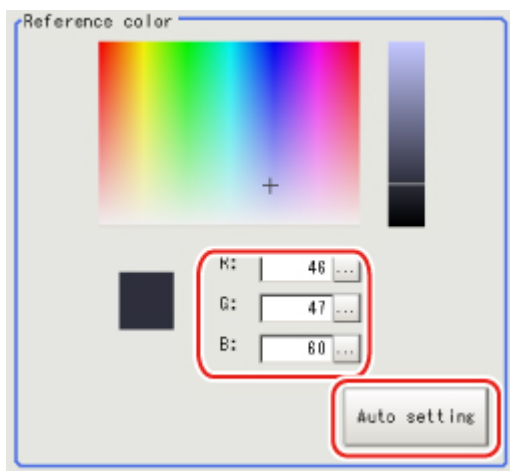

Setting methods	Description
Color chart	Tapping the color chart displays the RGB values for the specified color at the bottom.
R, G, B	Set the RGB values with numbers.
Auto setting	If you tap [Auto setting], the average color of the measurement region is displayed as the reference color.

- When the setting has been changed, tap [Measurement] in the Detail area to verify whether measurements can be made correctly.

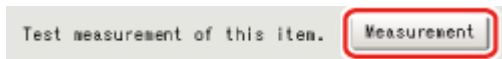

- Set up the judgement condition.

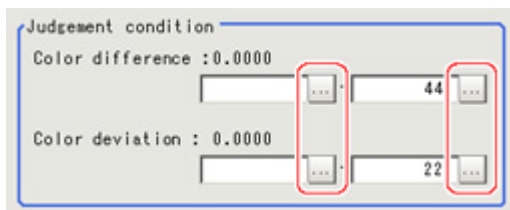

Setting item	Set value	Description
Color difference	0 to 442	Specify the upper and lower limit values for the difference between the average color of the measurement region and the reference color.
Color deviation	0 to 221	Specify the upper and lower limit values for the deviation of the average color in the measurement region.

For Monochrome Cameras:

- In the Item Tab area, tap [Measurement].

2. Set up the judgement condition.

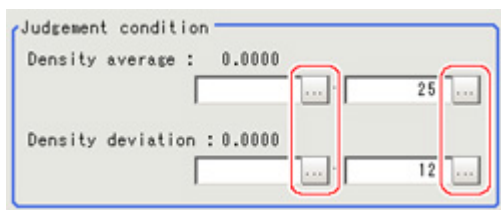

Setting item	Set value	Description
Density average	0 to 255	Specify the upper and lower limit values for judging the average density of the measurement region.
Density deviation	0 to 127	Specify the upper and lower limit values for the deviation of the average density in the measurement region.

Output Parameters (Color Data)

Specifies whether or not the judgement results of this processing unit is reflected in the scene overall judgement.

1. Tap [Output parameter] in the Item Tab area.
2. Choose whether or not to reflect this in the scene overall judgement in "Reflect to overall judgement" area.



Setting item	Set value [factory default]	Description
Reflect to overall judgement	<ul style="list-style-type: none"> • [ON] • OFF 	Enables choosing whether or not the judgement results of this processing unit is reflected in the scene overall judgement.

Key Points for Test Measurement and Adjustment (Color Data)

The following content can be confirmed in the "Detail result" area using text.

For color cameras

Displayed items	Description
Judge	Judgement result
Average R	R (red) element average value
Average G	G (green) element average value
Average B	B (blue) element average value
Color difference	The color difference between the average color and reference color in the measurement region
Color deviation	Color deviation in the measurement region

For monochrome cameras

Displayed items	Description
Judge	Judgement result
Density average	Difference between the average density and the reference density in the measurement region
Density deviation	Density deviation in the measurement region

Key Points for Adjustment

Select the adjustment method referring to the following points.

When the measurement results are unstable

Parameter to be adjusted	Remedy
Measurement	For a color camera, place a check at [Normalization].

When the processing speed is slow

Parameter to be adjusted	Remedy
Region setting	Set the measurement region to be as small as possible.

Measurement Results for Which Output Is Possible (Color Data)

The following values can be output using processing items related to results output. It is also possible to reference measurement values from expressions and other processing units.

For color cameras

Measurement items	Character string	Description
Judgement	JG	Judgement result
R average	AR	R (red) element average value
G average	AG	G (green) element average value
B average	AB	B (blue) element average value
Color difference	AD	The color difference between the average color and reference color in the measurement region
Color deviation	DV	Color deviation in the measurement region

For monochrome cameras

Measurement items	Character string	Description
Judgement	JG	Judgement result
Density average	AD	Difference between the average density and the reference density in the measurement region
Deviation	DV	Color deviation in the measurement region

Gravity and Area

Inspect using the area of the specified color.

Used in the Following Case

- Label deviation measurement

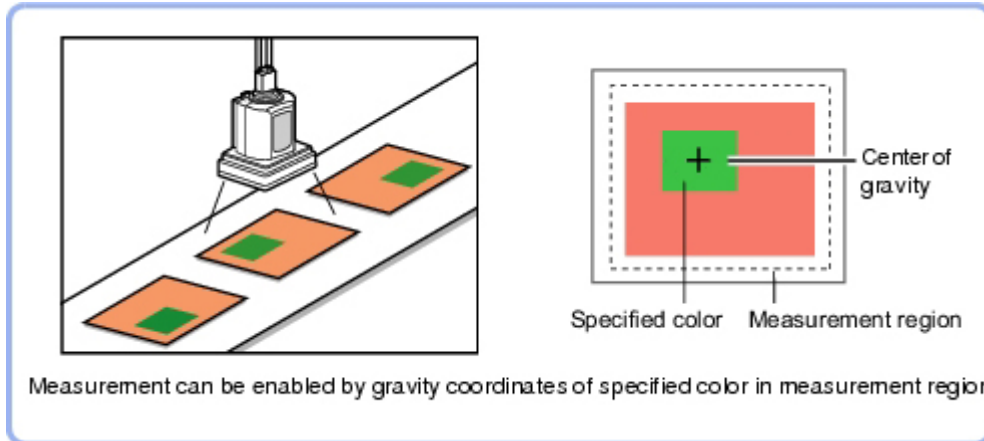

- Detection of defects, contamination, and stains of measurement objects whose appearance is not defined

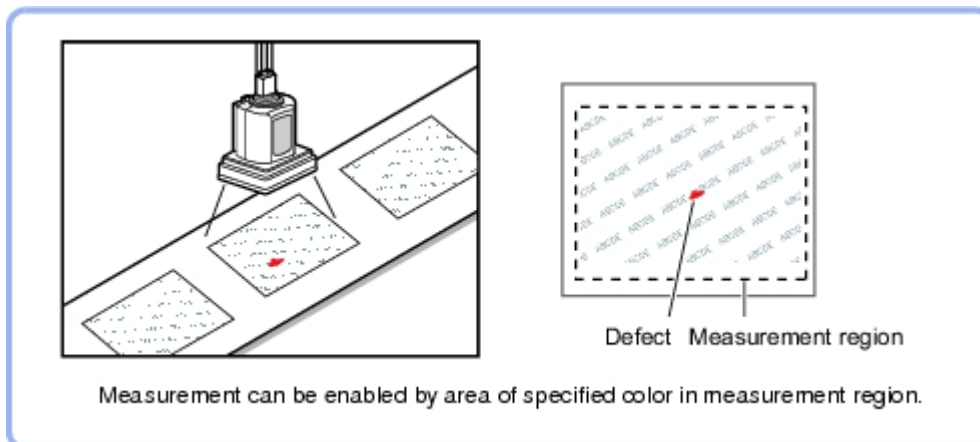

Settings Flow (Gravity and Area)

Set the Gravity and Area with the following steps.

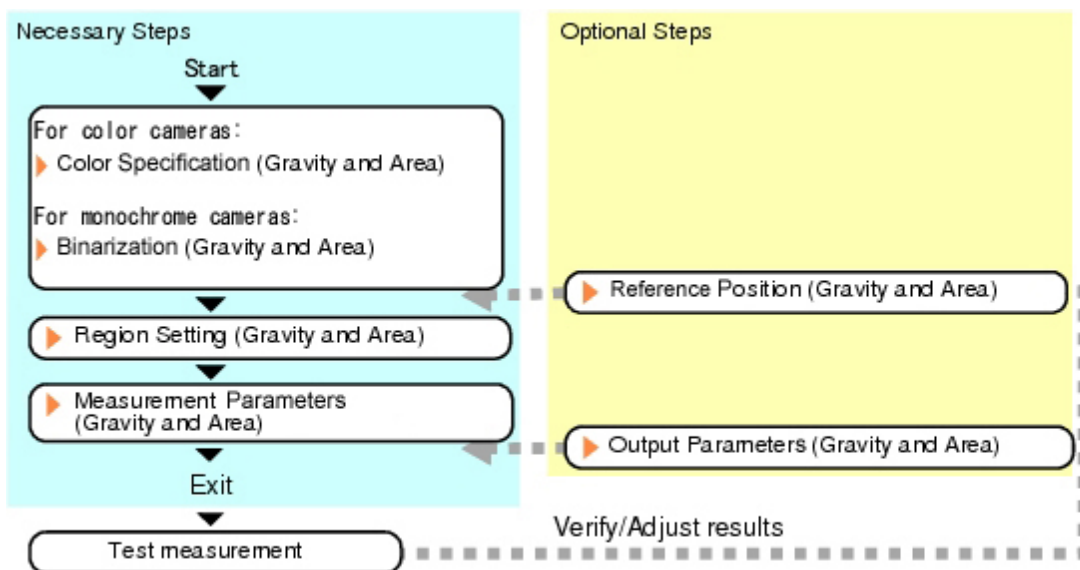

List of Gravity and Area Items

Item name	Description
Color (for color cameras only)	This item selects the color whose area and center of gravity are to be measured. Since the color hue, color saturation, and brightness can be selected, then fine-tuning can be performed to colors. Reference: ▶ Color Specification (Gravity and Area) (p.170)
Binary (for monochrome cameras only)	This item specifies the binary level for converting 256-tone grayscale images input from the camera into binary images. Converted white pixels are measured. Adjust the binary level so that the measurement object is converted to white pixels. Reference: ▶ Binarization (Gravity and Area) (p.172)
Region setting	This item is used to set up the measurement area. While the input image can be measured as a whole, a quick and reliable measurement can be performed by set up the measured range. Reference: ▶ Region Setting (Gravity and Area) (p.173)
Ref. position	This item can be changed if necessary. Usually, the central position of the registered region is registered as the reference position. Reference: ▶ Reference Position (Gravity and Area) (p.174)
Measurement	This item specifies the judgement condition for measurement results. Specify the upper and lower limit values for the area and the gravity center X/Y. Measurement parameter can be changed as needed to address unstable measurement results or to increase the processing speed. Normally, the factory default value will be used. Reference: ▶ Measurement Parameters (Gravity and Area) (p.175)
Output parameter	This item can be changed if necessary. Normally, the factory default value will be used. Use the output parameter to specify how to handle the coordinates. Reference: ▶ Output Parameters (Gravity and Area) (p.177)

Color Specification (Gravity and Area)

When connecting a color camera, specify the color to be measured. There are two specification methods: specifying the color to be extracted in the image or specifying the color with the hue, saturation, and brightness values.

This section describes how to specify colors in an image and gives an example of the procedure for finely adjusting with numeric input afterwards.

1. In the Item Tab area, tap [Color].
2. Place a check at [Auto setting].
3. In the Image Display area, specify the color range you want to detect by dragging the cursor from the upper left corner to the lower right corner of that area.
The color of the specified area is automatically set.

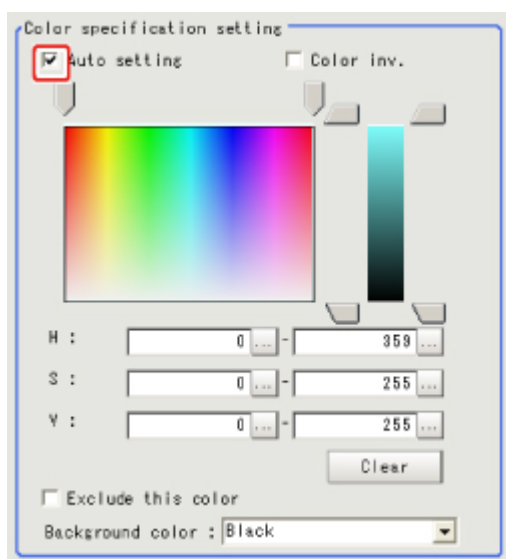

4. Finely adjust the hue, saturation, and brightness if necessary.
Adjust either by adjusting on the color chart or by inputting numbers.

Item	Set value [factory default]	Description
H	0 to 359	Specify the color phase (difference of color hues).
S	0 to 255	Specify color saturation (difference of color saturation).
V	0 to 255	Specify the brightness (difference of brightness).
Auto setting	<ul style="list-style-type: none"> • Checked • [Unchecked] 	Specifying the color to be measured on the image automatically sets the hue, saturation, and brightness.
Color reverse	<ul style="list-style-type: none"> • Checked • [Unchecked] 	Everything other than the specified color becomes the measurement target.

About color charts

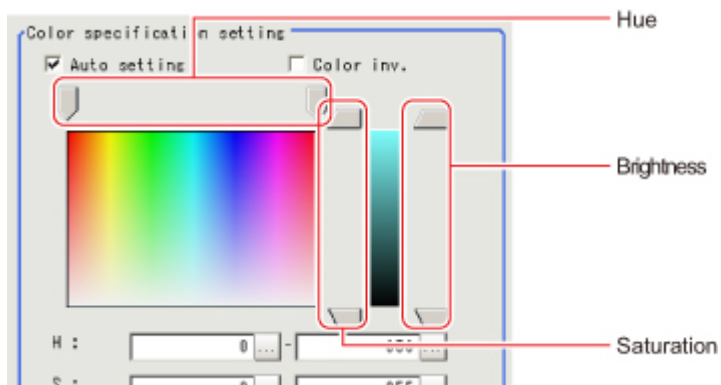

5. To specify multiple colors, place a check at "More ranges of color extraction".



Setting item	Set value [factory default]	Description
More ranges of color extraction	<ul style="list-style-type: none"> • Checked • [Unchecked] 	If you place a check at this option, you can set up to 8 colors.

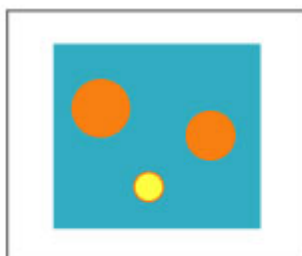

Extract image (before specifying colors)

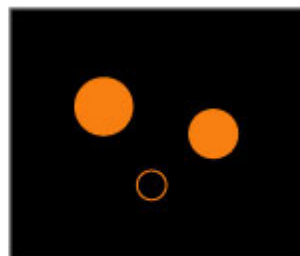

Extract image (after specifying colors - background color:black)

6. If necessary, set the display conditions for displayed images.

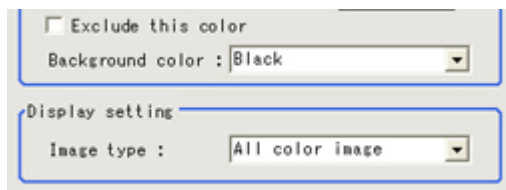

Setting item	Set value [factory default]	Description
Exclude this color	<ul style="list-style-type: none"> • Checked • [Unchecked] 	If you place a check at this option, pixels within the HSV range are excluded from color extraction. The priority order for exclusion is that the higher color extraction range numbers are given priority. This setting is disabled if "More ranges of color extraction" is unchecked.

Background color	<ul style="list-style-type: none"> • [Black] • White • Red • Green • Blue 	The background section outside the extracted image is filled with the specified colors.
Image type	<ul style="list-style-type: none"> • Measurement image • [All color image] • Selected color image • Binary image 	This sets the state of the image to display.

Binarization (Gravity and Area)

When a monochrome camera is connected, the 256-tone grayscale images taken in from the camera are converted into binary black-and-white images before the images are measured. Converted white pixels are measured.

This specifies the level for converting grayscale images into binary images.

1. In the Item Tab area, tap [Binary].
2. In the "Binary setting" area, specify the reference density range.

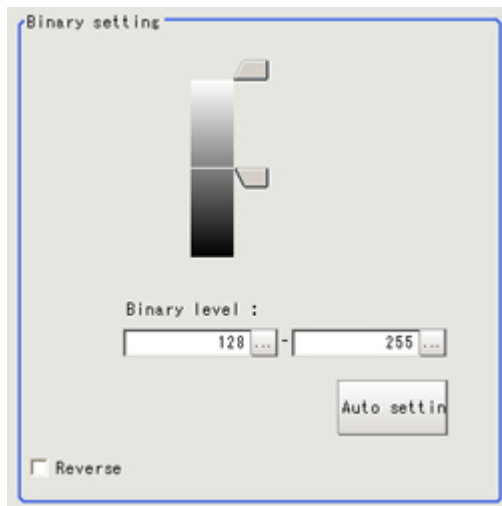

Item		Set value [factory default]	Description
Binary level	Upper limit	0 to 255 [255]	Specify the level for converting 256-tone grayscale images to binary images. Adjust the binary level so that the measurement object is converted to white pixels. You can also set the binary level so that only intermediate density is measured.
	Lower limit	0 to 255 [128]	
Auto setting		–	Optimum binary levels are calculated automatically and set.
Reverse		<ul style="list-style-type: none"> • Checked • [Unchecked] 	This item reverses black and white colors.

Region Setting (Gravity and Area)

This item is used to set up the measurement area. It is possible to measure the entire input image, but restricting the range enables accurate measurement in a short period of time.

Use a rectangle, circle (ellipse), circumference, or polygon to specify a measurement region for [Gravity and Area]. Up to 8 figures can be combined to draw the measurement region.

1. In the Item Tab area, tap [Region setting].
2. Use the Drawing tools to specify the measurement region.

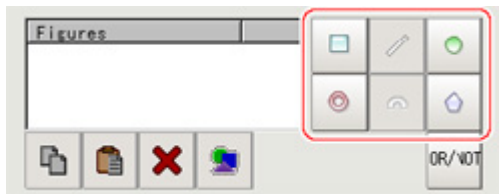

3. In the figure setting area, tap [OK].
The measurement region is registered and displayed in the Image Display area.

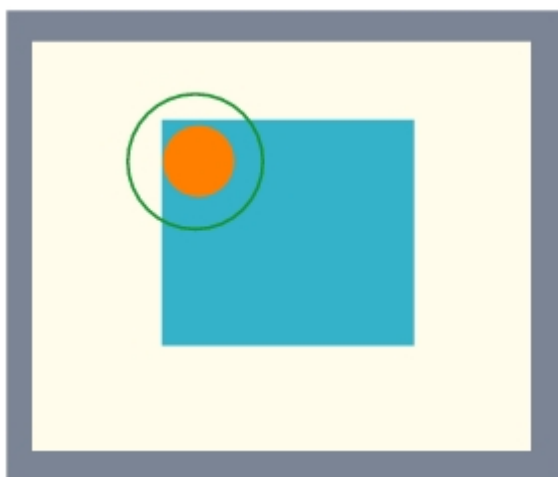

4. If necessary, in the "Display setting" area, set up display settings for the images displayed in the Image Display area.
For color cameras:

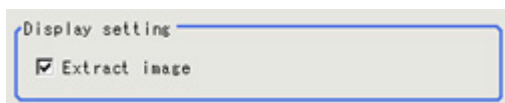

Setting item	Set value [factory default]	Description
Extracted image	<ul style="list-style-type: none"> • [Checked] • Unchecked 	If you place a check at this option, images set with color specification are displayed.

For monochrome cameras:

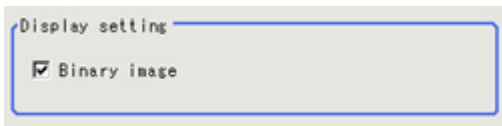

Setting item	Set value [factory default]	Description
Binary image	<ul style="list-style-type: none"> • [Checked] • Unchecked 	The image is displayed in binary with black and white.

Reference Position (Gravity and Area)

When the measurement region is set, the center of gravity is automatically set at the same time as the reference position. This item is used to change the reference position to any desired position. This is handy for measuring the positional deviation from a certain position. In the same way for the reference area, when the region settings are made, they are set automatically based on the measurement region.

1. In the Item Tab area, tap [Ref. position].
In the Image Display area, the current reference position will be displayed as the crosshair cursor.
2. Tap the position to be set as the reference position.

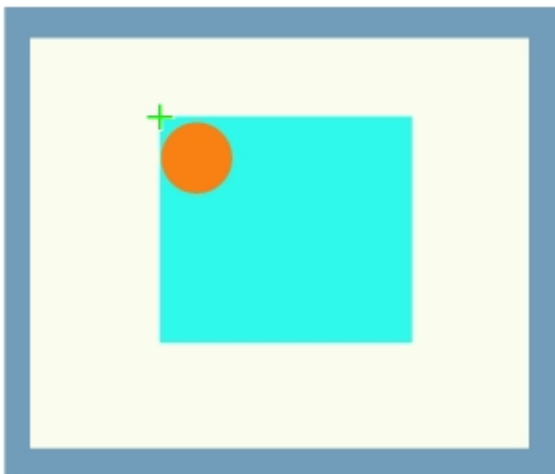

Note

- Displaying the image enlarged makes this tapping easier.
Reference: ▶ "Using the Zoom Function" in the "User's Manual" (p.347)

3. If necessary, finely adjust with numeric input and the arrow buttons.

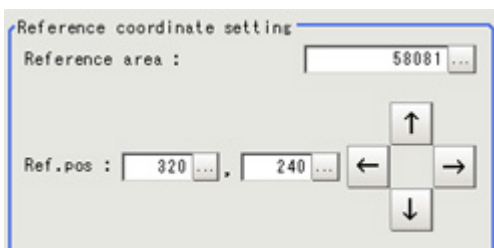

4. If necessary, in the "Display setting" area, set up display settings for the images displayed in the Image Display area.

For color cameras:

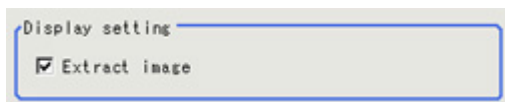

Setting item	Set value [factory default]	Description
Extract image	<ul style="list-style-type: none"> • [Checked] • Unchecked 	If you place a check at this option, images set with color specification are displayed.

For monochrome cameras:

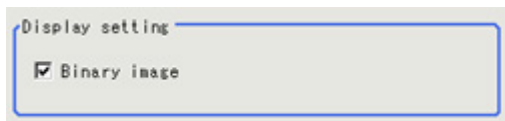

Setting item	Set value [factory default]	Description
Binary image	<ul style="list-style-type: none"> • [Checked] • Unchecked 	The image is displayed in binary with black and white.

Measurement Parameters (Gravity and Area)



This item specifies the judgement condition for measurement results. Specify the upper and lower limit values for the area and the gravity center X/Y.

Measurement parameter can be changed as needed to address unstable measurement results or to increase the processing speed. Normally, the factory default value will be used.

1. In the Item Tab area, tap [Measurement].
2. If necessary, in the "Measurement condition" area, select an option for [Fill outline].

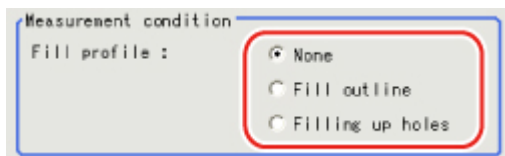
If the measurement target has holes in it, specify how to process the holes. Normally, the factory default value will be used.



Setting item	Set value [factory default]	Description
	[None]	The empty section in the center is not filled in.
Fill outline		<p>In the measurement region, the part between the extracted-color start point and end point in the X-axis direction is measured as having the extracted color. Since filling is applied only to the X-axis direction, the processing is faster than filling up holes.</p> <p>Input image Fill profile image</p> 
Filling up holes		<p>The part surrounded by the extracted color, like a doughnut hole, is filled with the extracted color.</p> <p>Input image Image after filling up hole</p> 

- If necessary, in the "Display setting" area, set up display settings for the images displayed in the Image Display area.

For color cameras:

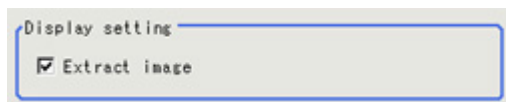

Setting item	Set value [factory default]	Description
Extract image	<ul style="list-style-type: none"> • [Checked] • Unchecked 	If you place a check at this option, images set with color specification are displayed.

For monochrome cameras:

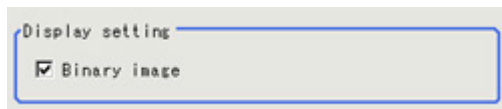

Setting item	Set value [factory default]	Description
Binary image	<ul style="list-style-type: none"> • [Checked] • Unchecked 	The image is displayed in binary with black and white.

- When the setting has been changed, tap [Measurement] in the Detail area to verify whether

measurements can be made correctly.



5. Set up the judgement condition.

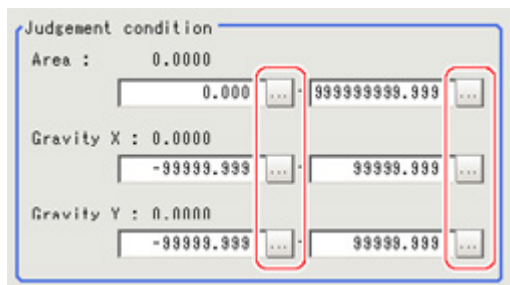

Note

- The values beside each item are measurement results of the displayed image. Take these values into consideration to determine the upper and lower limits.

Setting item	Set value	Description
Area	0 to 999999999.9999	Specify the area to be judged as OK.
Gravity X	-99999.9999 to 99999.9999	Specify the range of X-axis shifting that is judged to be OK.
Gravity Y	-99999.9999 to 99999.9999	Specify the range of Y-axis shifting that is judged to be OK.

Output Parameters (Gravity and Area)

Specify how to treat the coordinates to be output to the external device as measurement results. This item can be changed if necessary. Normally, the factory default value will be used.

Important

- After setting up the measurement parameters, changing the output parameters will cause measurement results to vary accordingly. If the output parameters have been changed, re-specify the measurement, too.

1. Tap [Output parameter] in the Item Tab area.
2. Specify each of the following items.

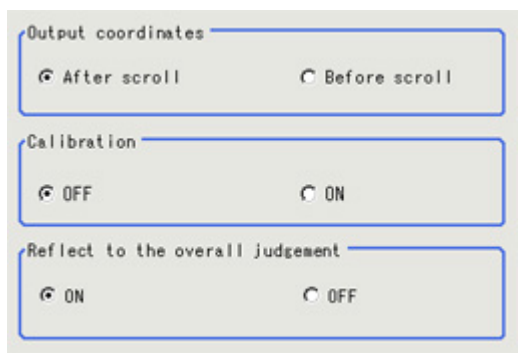

Setting item	Set value [Factory default]	Description
Output Coordinates	<ul style="list-style-type: none"> · [After scroll] · Before scroll 	As measurement results, select whether to output coordinate values to external devices before or after the position deflection correction is applied.
Calibration	<ul style="list-style-type: none"> · [OFF] · ON 	Select whether to reflect the calibration in the values output to the external device as measurement results. ON: Output the coordinates converted into actual dimensions. OFF: Output the camera coordinate values.
Reflect to overall judgement	<ul style="list-style-type: none"> · [ON] · OFF 	Enables choosing whether or not the judgement result of this processing unit is reflected in the scene overall judgement.

Key Points for Test Measurement and Adjustment (Gravity and Area)

The following content is displayed in the "Detail result" area as text.

Displayed items	Description
Judge	Judgement result
Area	Area
Gravity X	Gravity X
Gravity Y	Gravity Y

Key Points for Adjustment

Select the adjustment method referring to the following points.

When the measurement results are unstable

For color cameras:

Parameter to be adjusted	Remedy
Color	Tap the area whose color will be sampled and the area whose color will not be sampled. The setup should be such that two stable sections of hue, saturation and brightness are formed.

For monochrome cameras:

Parameter to be adjusted	Remedy
Color	Adjust the binary level.

Measurement Results for Which Output Is Possible (Gravity and Area)

The following values can be output using processing items related to results output. It is also possible to reference measurement values from expressions and other processing units.

Measurement items	Character string	Description
Judgement	JG	Judgement result
Area	AR	Area
Gravity X	X	Center of gravity X coordinate
Gravity Y	Y	Center of gravity Y coordinate
Reference area	SA	Reference area
Reference point X	SX	Reference position X coordinate
Reference point Y	SY	Reference position Y coordinate

Labeling

You can count the number of labels with a specified color or find the area and center of gravity of a specified label number.

Used in the Following Case

- Label count inspection

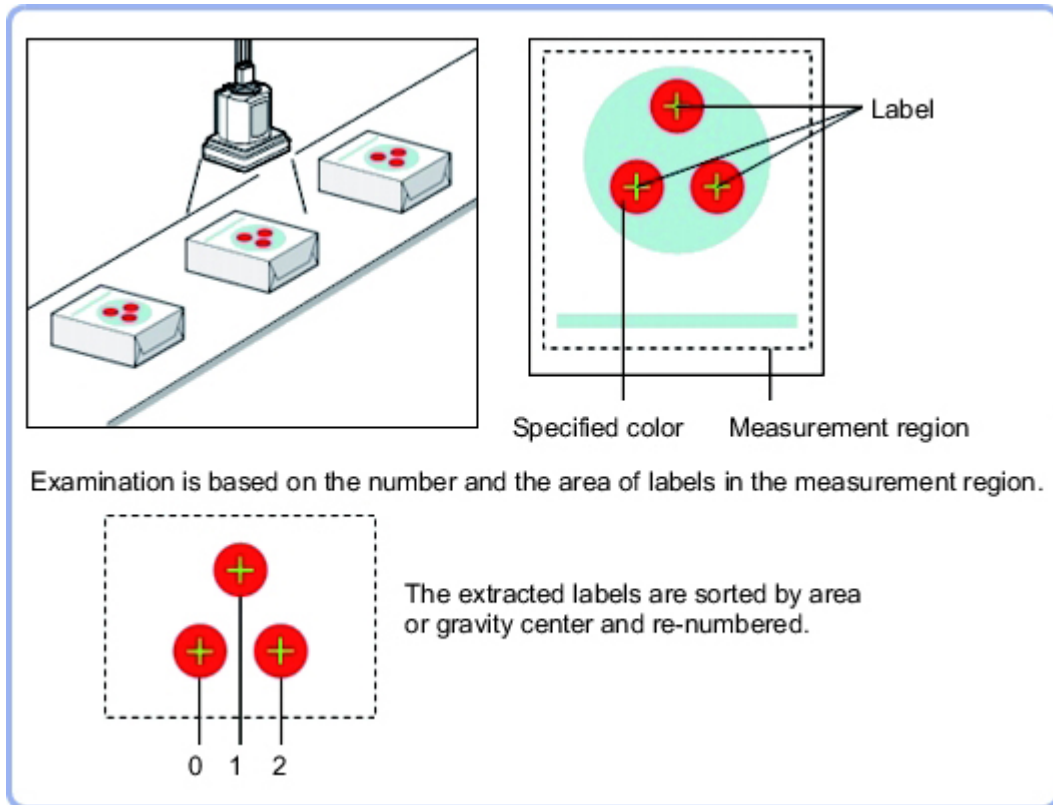

Settings Flow (Labeling)

Labeling can be set up as follows.

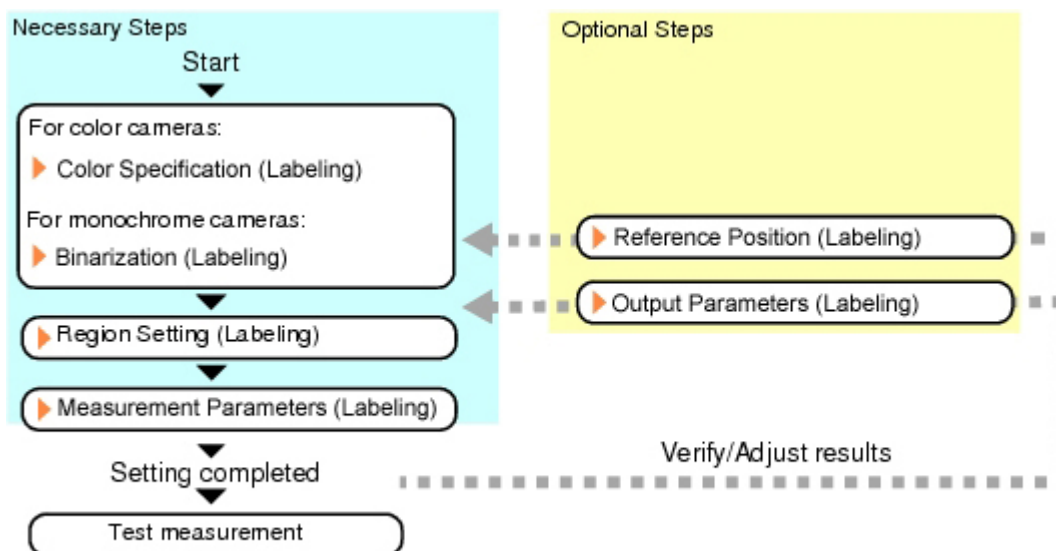

List of Labeling Items

Item name	Description
Color (for color cameras only)	This item selects the color whose area and center of gravity are to be measured. Since the color hue, color saturation, and brightness can be selected, then fine-tuning can be performed to colors. Reference: ▶ Color Specification (Labeling) (p.181)
Binary (for monochrome cameras only)	This item specifies the binary level for converting 256-tone grayscale images input from the camera into binary images. Converted white pixels are measured. Adjust the binary level so that the measurement object is converted to white pixels. Reference: ▶ Binarization (Labeling) (p.184)
Region setting	This item is used to set up the measurement area. While the input image can be measured as a whole, a quick and reliable measurement can be performed by set up the measured range. Reference: ▶ Region Setting (Labeling) (p.185)
Ref. position	This item can be changed if necessary. Usually, the central position of the registered region is registered as the reference position. Reference: ▶ Reference Position (Labeling) (p.186)
Measurement parameter	This item specifies the judgement condition for measurement results. It specifies the upper and lower limit values for the number of labels, the area and the center of gravity X and Y. Measurement parameter can be changed as needed to address unstable measurement results or to increase the processing speed. Normally, the factory default value will be used. Reference: ▶ Measurement Parameters (Labeling) (p.187)
Output parameter	This item can be changed if necessary. Normally, the factory default value may be used. Use the output parameter to specify how to handle the coordinates. Reference: ▶ Output Parameters (Labeling) (p.191)

Color Specification (Labeling)

When connecting a color camera, specify the color to be measured. There are two specification methods: specifying the color to be extracted in the image or specifying the color with the hue, saturation, and brightness values.

This section describes how to specify colors in an image and gives an example of the procedure for finely adjusting with numeric input afterwards.

1. In the Item Tab area, tap [Color].
2. Place a check at [Auto setting].
3. In the Image Display area, specify the color range you want to detect by dragging the cursor from the upper left corner to the lower right corner of that area.
The color of the specified area is automatically set.

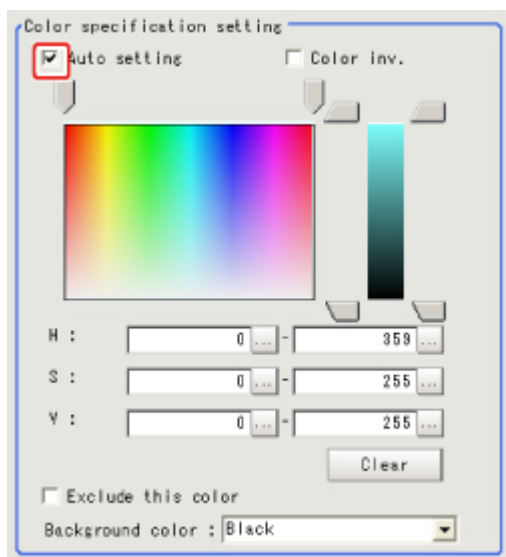

4. Finely adjust the hue, saturation, and brightness if necessary.
Adjust either by adjusting on the color chart or by inputting numbers.

Item	Set value [Factory default]	Description
H	0 to 359	Specify the color phase (difference of color hues).
S	0 to 255	Specify color saturation (difference of color saturation).
V	0 to 255	Specify the brightness (difference of brightness).
Auto setting	<ul style="list-style-type: none"> • Checked • [Unchecked] 	Specifying the color to be measured on the image automatically sets the hue, saturation, and brightness.
Color inv.	<ul style="list-style-type: none"> • Checked • [Unchecked] 	Everything other than the specified color becomes the measurement target.

About color charts

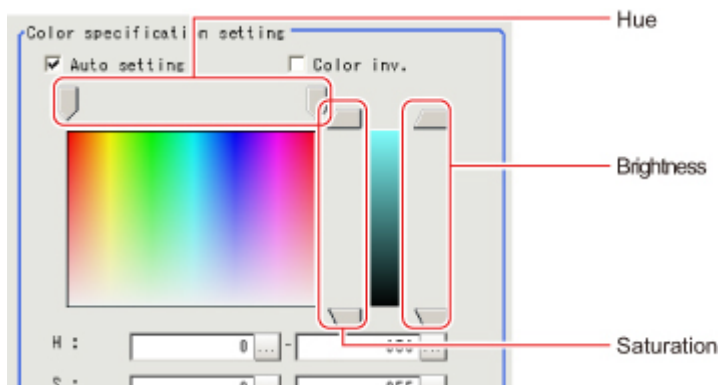

5. To specify multiple colors, place a check at "More ranges of color extraction".



Setting item	Set value [Factory default]	Description
More ranges of color extraction	<ul style="list-style-type: none"> • Checked • [Unchecked] 	If you place a check at this option, you can set up to 8 colors.



Extract image (before specifying colors)

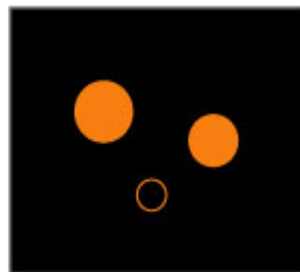

Extract image (after specifying colors - background color:black)

6. If necessary, set the display conditions for displayed images.

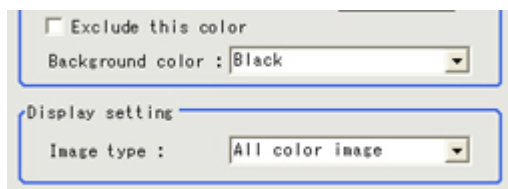

Setting item	Set value [Factory default]	Description
Exclude this color	<ul style="list-style-type: none"> • Checked • [Unchecked] 	If you place a check at this option, pixels within the HSV range are excluded from color extraction. The priority order for exclusion is that the higher color extraction range numbers are given priority. This setting is disabled if "More ranges of color extraction" is unchecked.
Background color	<ul style="list-style-type: none"> • [Black] • White • Red • Green • Blue 	The background section outside the extracted image is filled with the specified colors.
Image type	<ul style="list-style-type: none"> • Measurement image • [All color image] • Selection color image • Binary image 	This sets the state of the image to display.

Binarization (Labeling)

When a monochrome camera is connected, the 256-tone grayscale images taken in from the camera are converted into binary black-and-white images before the images are measured. Converted white pixels are measured.

This specifies the level for converting grayscale images into binary images.

1. In the Item Tab area, tap [Binary].
2. In the "Binary setting" area, specify the reference density range.

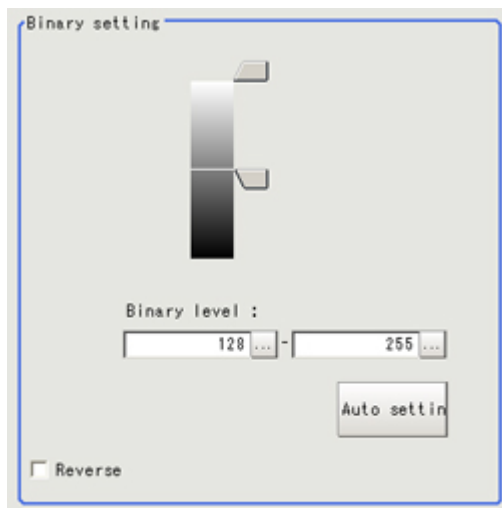

Item	Set value [Factory default]	Description
Binary level	Upper limit	0 to 255 [255]
	Lower limit	0 to 255 [128]

Specify the level for converting 256-tone grayscale images to binary images. Adjust the binary level so that the measurement object is converted to white pixels. You can also set the binary level so that only intermediate density is measured.

Auto setting	-	Optimum binary levels are calculated automatically and set.
Reverse	<ul style="list-style-type: none"> • [Checked] • Unchecked 	This item reverses black and white colors.

Region Setting (Labeling)

This item is used to set up the measurement area. It is possible to measure the entire input image, but restricting the range enables accurate measurement in a short period of time. Use a rectangle, straight line, circle (ellipse), wide circle, or polygon to specify a measurement region for [Labeling].

1. In the Item Tab area, tap [Region setting].
2. Use the Drawing tools to specify the measurement region.

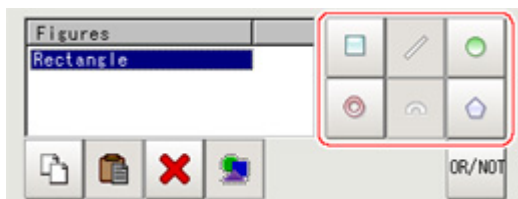

3. In the figure setting area, specify a region to be measured.
4. In the figure setting area, tap [OK].
The measurement region is registered and displayed in the Image Display area.

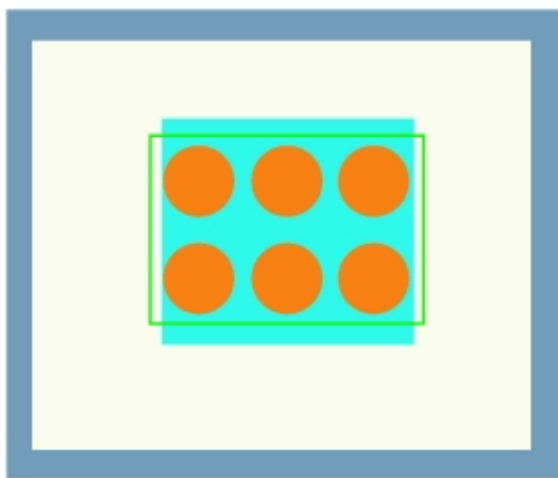

5. If necessary, in the "Display setting" area, set up display settings for the images displayed in the Image Display area.
For color cameras:

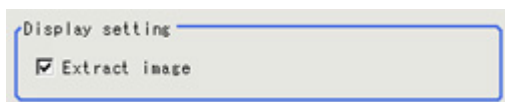

Setting item	Set value [Factory default]	Description
Extracted image	<ul style="list-style-type: none"> • [Checked] • Unchecked 	If you place a check at this option, images set with color specification are displayed.

For monochrome cameras:

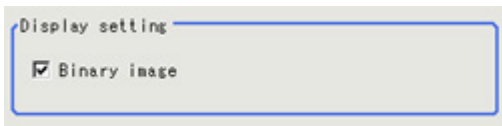

Setting item	Set value [Factory default]	Description
Binary image	<ul style="list-style-type: none"> • [Checked] • Unchecked 	The image is displayed in binary with black and white.

Reference Position (Labeling)

This item can be changed if necessary. When the region is set, the reference position is automatically set at the center of gravity of the measurement region. In the same way for the reference area, when the region settings are made, they are set automatically based on the measurement region.

This item can be used to change the reference position to any desired position.

1. In the Item Tab area, tap [Ref. position].
In the Image Display area, the current reference position will be displayed as the crosshair cursor.
2. Tap the position to be set as the reference position.

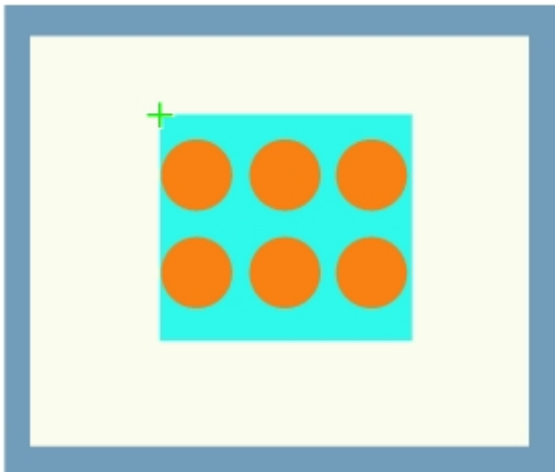

Note

- Displaying the image enlarged makes this tapping easier.
Reference: ▶ "Using the Zoom Function" in the "User's Manual" (p.347)

3. If necessary, finely adjust with numeric input and the arrow buttons.

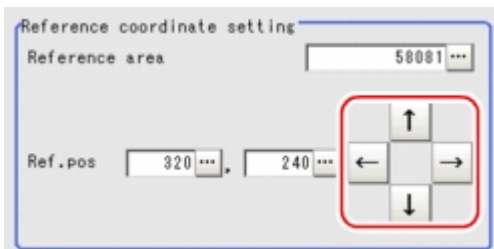

4. If necessary, in the "Display setting" area, set up display settings for the images displayed in the Image Display area.

For color cameras:

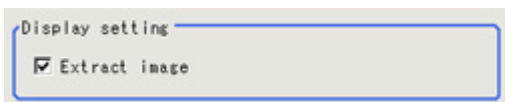

Setting item	Set value [Factory default]	Description
Extract image	<ul style="list-style-type: none"> • [Checked] • Unchecked 	If you place a check at this option, images set with color specification are displayed.

For monochrome cameras:

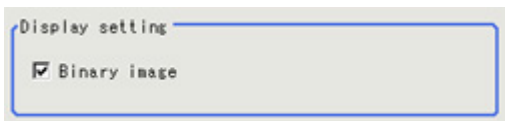

Setting item	Set value [Factory default]	Description
Binary image	<ul style="list-style-type: none"> • [Checked] • Unchecked 	The image is displayed in binary with black and white.

Measurement Parameters (Labeling)

This item specifies the judgement condition for measurement results. Measurement parameters can be changed as needed to address unstable measurement results or to increase the processing speed. Normally, the factory default value will be used.

1. In the item tab area, tap [Measurement].
2. If necessary, in the "Labeling condition" area, specify a value for each item.

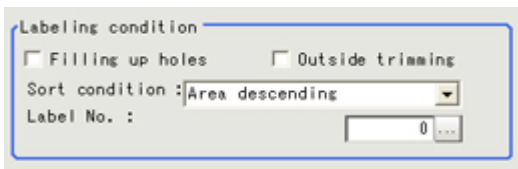

Setting item	Setting value [Factory default]	Description
Filling up holes	<ul style="list-style-type: none"> • Checked • [Unchecked] 	<p>Select the process method for the part encircled by the designated color circle. When checked, the hole is processed as having the specified color.</p> <p>Input image Image after filling up hole</p>

<p>Outside trimming</p>	<ul style="list-style-type: none"> • Checked • [Unchecked] 	<p>This option can be used only when there is a section of the designated color in the measurement region that does not need to be measured.</p> <p>When "Checked" is set, the whole area outside of the measurement region is extracted as having the specified color.</p> 
<p>Sort type</p>	<ul style="list-style-type: none"> • Area ascending • [Area descending] • X ascending • X descending • Y ascending • Y descending • Elliptic major axis ascending • Elliptic major axis descending • Elliptic minor axis ascending • Elliptic minor axis descending • Elliptic ratio ascending • Elliptic ratio descending • Rectangle width ascending • Rectangle width descending • Rectangle height ascending • Rectangle height descending • Rectangle X1 ascending • Rectangle X1 descending • Rectangle Y1 ascending • Rectangle Y1 descending 	<p>Specify the conditions by which label number is re-assigned.</p> <p>When sorting referencing the X and Y coordinates, the upper left is the origin.</p>
<p>Label No.</p>	<p>[0] to 2499</p>	<p>Input the label No. for the data to be output.</p>

3. If necessary, in the "Display setting" area, set up display settings for the images displayed in the "Image display" area.

For color cameras:

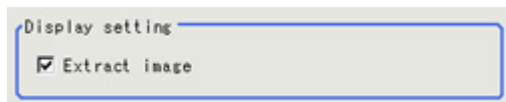

Setting item	Setting value [Factory default]	Description
Extract image	<ul style="list-style-type: none"> • [Checked] • Unchecked 	If you place a check at this option, image set with the color specification is displayed.

For monochrome cameras:

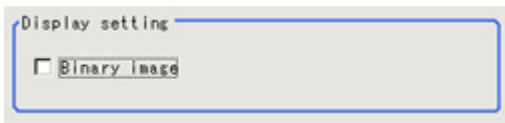

Setting item	Setting value [Factory default]	Description
Binary image	<ul style="list-style-type: none"> • [Checked] • Unchecked 	The image is displayed in binary with black and white.

4. Set the extraction conditions.

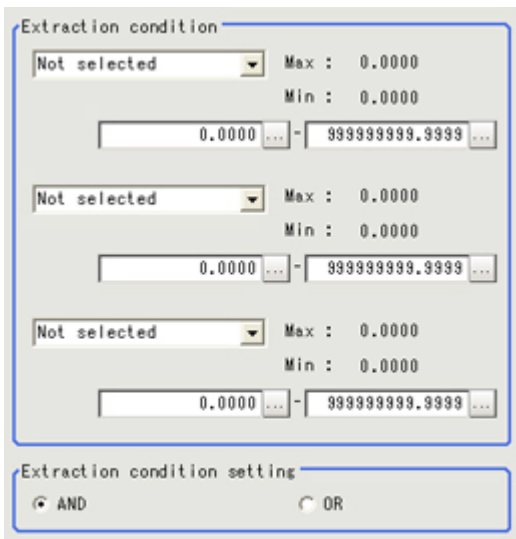

Setting item	Setting value [Factory default]	Description
Extraction condition	<ul style="list-style-type: none"> • [OFF] • Area • Gravity X • Gravity Y • Elliptic major axis • Elliptic minor axis • Elliptic ratio • Rectangle width • Rectangle height • Rectangle X1 • Rectangle Y1 	The image is displayed in binary with black and white.
Extraction condition setting	<ul style="list-style-type: none"> • [AND] • OR 	Set the "Extraction conditions". AND: When all the set "Extraction conditions" are fulfilled. OR: When any of the set "Extraction conditions" is fulfilled.

5. When the setting has been changed, tap [Measurement] in the "Detail" area to verify whether measurements can be made correctly.



Judgement Conditions (Labeling)

1. In the item tab area, tap [Judgement].
2. If necessary, specify a value for each item.

To set feature quantities 4-7, tap the [Feature quantity 4-7] button.

Setting item	Setting value [Factory default]	Description
Judgement condition		
<ul style="list-style-type: none"> • [OFF] • Number of labels • Total area • Area • Gravity X • Gravity Y • Elliptic axis angle • Elliptic major axis • Elliptic minor axis • Elliptic ratio • Rectangle width • Rectangle height • Rectangle X1 • Rectangle Y1 	0.000 to 9999999.999	Set up the judgement condition.

3. If necessary, in the "Display setting" area, set up display settings for the images displayed in the "Image display" area.

For color cameras:

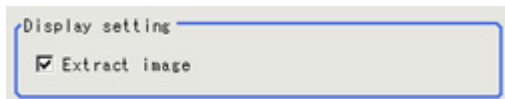

Setting item	Setting value [Factory default]	Description
Extract image	<ul style="list-style-type: none"> • [Checked] • Unchecked 	If you place a check at this option, image set with the color specification is displayed.

For monochrome cameras:

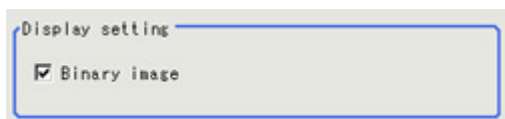

Setting item	Setting value [Factory default]	Description
Binary image	<ul style="list-style-type: none"> • [Checked] • Unchecked 	The image is displayed in binary with black and white.

Output Parameters (Labeling)

Specify how to treat the coordinates to be output to the external device as measurement results. This item can be changed if necessary. Normally, the factory default value will be used.

Important

- After setting up the measurement parameters, changing the output parameters will cause measurement results to vary accordingly. If the output parameters have been changed, re-specify the measurement, too.

1. Tap [Output parameter] in the Item Tab area.
2. Specify each of the following items.

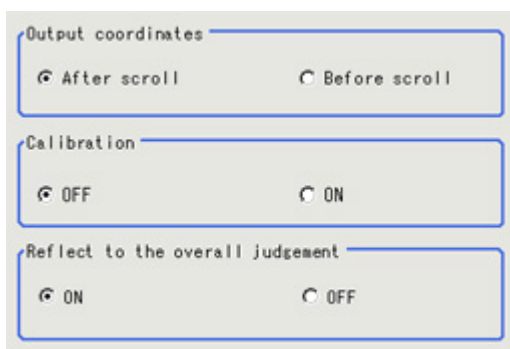

Setting item	Set value [Factory default]	Description
Output Coordinates	<ul style="list-style-type: none"> • [After scroll] • Before scroll 	As measurement results, select whether to output coordinate values to external devices before or after the position deflection correction is applied.

Calibration	<ul style="list-style-type: none"> • [OFF] • ON 	Select whether to reflect the calibration in the values output to the external device as measurement results. ON: Output the coordinates converted into actual dimensions. OFF: Output the camera coordinate values.
Reflect to overall judgement	<ul style="list-style-type: none"> • [ON] • OFF 	Enables choosing whether or not the judgement result of this processing unit is reflected in the scene overall judgement.

Key Points for Test Measurement and Adjustment (Labeling)

The following content is displayed in the "Detail result" area as text.

Displayed items	Description
Judge	Judgement result
Number of labels	Number of labels
Area	Area
Gravity X	Gravity X
Gravity Y	Gravity Y

Key Points for Adjustment

Select the adjustment method referring to the following points.

When the measurement results are unstable

For color cameras:

Parameter to be adjusted	Remedy
Color	Tap the area whose color will be sampled and the area whose color will not be sampled. The setup should be such that two stable sections of hue, saturation and brightness are formed.

For monochrome cameras:

Parameter to be adjusted	Remedy
Color	Adjust the binary level.

Measurement Results for Which Output Is Possible (Labeling)

The following values can be output using processing items related to results output. It is also possible to reference measurement values from expressions and other processing units.

Measurement items	Character string	Description
Judgement	JG	Judgement result
Number of labels	L	Number of labels
Total area	TAR	Total area
Area	AR	Area

Gravity X	X	Center of gravity X coordinate
Gravity Y	Y	Center of gravity Y coordinate
Reference area	SA	Reference area
Reference point X	SX	Reference position X coordinate
Reference point Y	SY	Reference position Y coordinate
Feature quantity 0 to 7	FDA to FDH	Measurement value of the feature quantity selected in the extraction conditions
Feature quantity 0 to 7 [0]	FDA0 to FDH0	Measurement date of feature quantity
Feature quantity 0 to 7 [1]	FDA1 to FDH1	Measurement date of feature quantity
Feature quantity 0 to 7 [2]	FDA2 to FDH2	Measurement date of feature quantity
.	.	.
.	.	.
.	.	.
Feature quantity 0 to 7 [99]	FDA99 to FDH99	Measurement date of feature quantity

Label Data

You can specify a desired label number and obtain measurement values for that label stored by other processing units.

The processing items that can be set up as reference objects are the following items that perform the labeling processing.

- Labeling

Used in the Following Case

- Label position acquisition

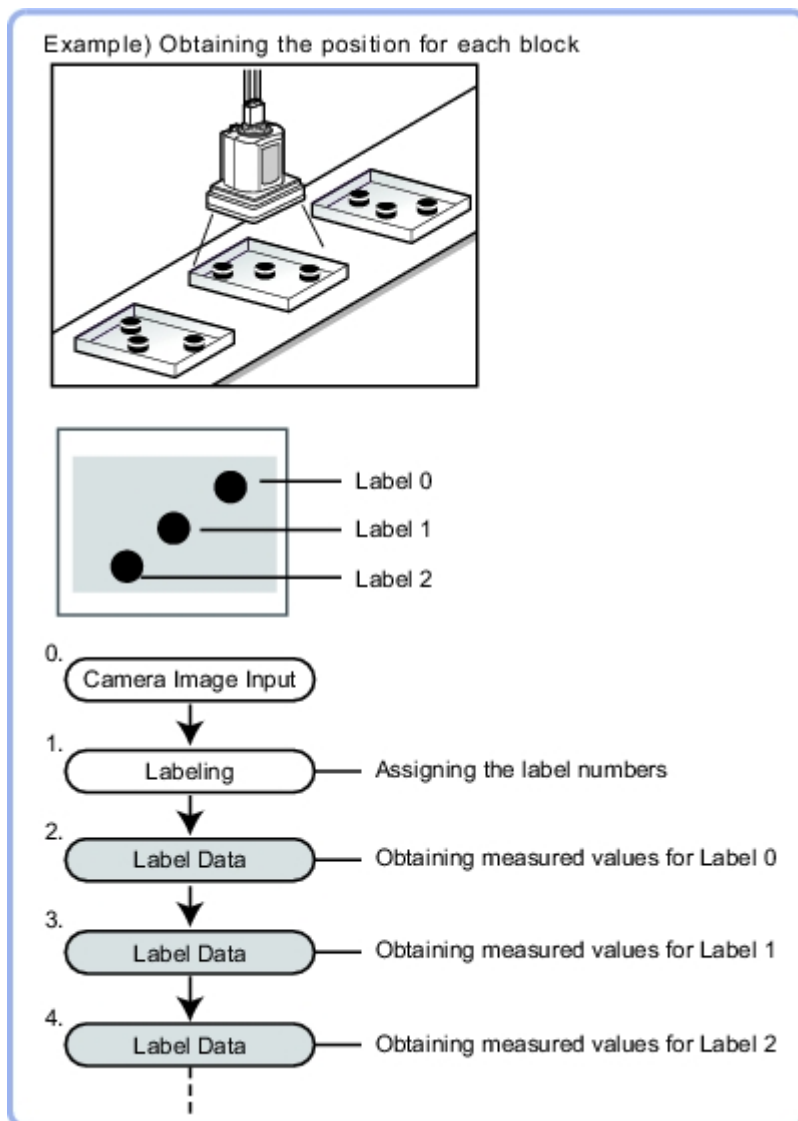

Note

- Do not insert the following processing items between Label Data and Labeling units.
 - Camera Image Input
 - Camera Switching
 - Position Compensation
 - Color Gray Filter
 - Filtering

Settings Flow (Label Data)

Set up the label data with the following steps.

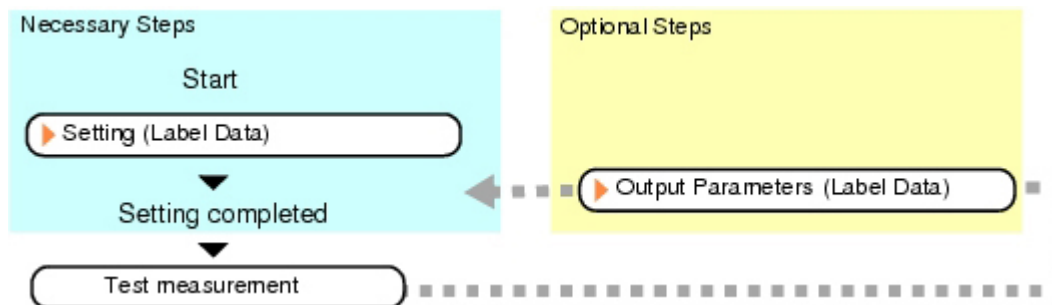

List of Label Data Items

Item name	Description
Setting	Specify the unit number and label number of the processing unit that is designated as the reference object. In addition, specify the judgement conditions for measurement results. Specify the upper and lower limit values for the area and the gravity center X/Y. Reference: ▶ Setting (Label Data) (p.195)
Output parameter	This item can be changed if necessary. Normally, the factory default value will be used. Use the output parameter to specify how to handle the coordinates. Reference: ▶ Output Parameters (Label Data) (p.196)

Setting (Label Data)

Specify the unit number and label number of the unit set for labeling reference. In addition, specify the judgement conditions for measurement results.

After changing a setting, check whether measurement can be done properly by performing an actual measurement.

1. In the Item Tab area, tap [Setting].
2. In the "Label setting" area, specify each item.

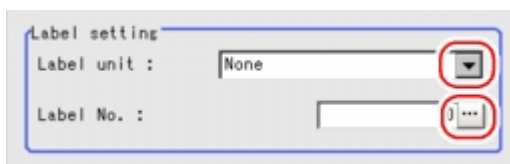

Setting item	Set value [Factory default]	Description
Label unit	[None] to 9999	Specify the number of the unit for which the reference object processing item has been set up. As an option, display the number of the unit for which the following processing items have been set up. • Labeling
Label No.	[0] to 2499	Specify the number of the label for the reference object.

3. When the setting has been changed, tap [Measurement] in the Detail area to verify whether

measurements can be made correctly.



4. Set up the judgement condition.

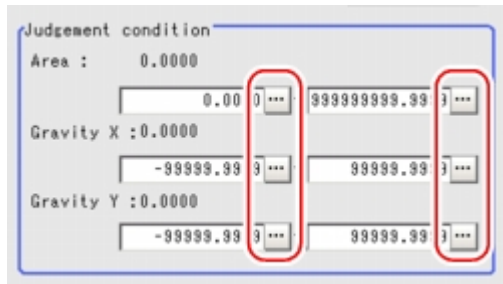

Note

- The value beside each item are measurement results of the displayed image. Take these values into consideration to determine the upper and lower limits.

Setting item	Set value	Description
Area	0 to 999999999.9999	Specify the area to be judged as OK.
Gravity X	-99999.9999 to 99999.9999	Specify the range of X-axis shifting that is judged to be OK.
Gravity Y	-99999.9999 to 99999.9999	Specify the range of Y-axis shifting that is judged to be OK.

Output Parameters (Label Data)

Specify how to treat the coordinates to be output to the external device as measurement results. This item can be changed if necessary. Normally, the factory default value will be used.

Important

- After setting up the measurement parameters, changing the output parameters will cause measurement results to vary accordingly. If the output parameters have been changed, re-specify the measurement, too.

1. Tap [Output parameter] in the Item Tab area.
2. Specify each of the following items.

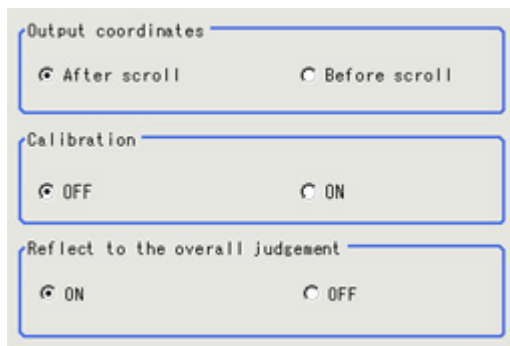

Setting item	Set value [Factory default]	Description
Output Coordinates	<ul style="list-style-type: none"> · [After scroll] · Before scroll 	As measurement results, select whether to output coordinate values to external devices before or after the position deflection correction is applied.
Calibration	<ul style="list-style-type: none"> · [OFF] · ON 	Select whether to reflect the calibration in the values output to the external device as measurement results. ON: Output the coordinates converted into actual dimensions. OFF: Output the camera coordinate values.
Reflect to overall judgement	<ul style="list-style-type: none"> · [ON] · OFF 	Enables choosing whether or not the judgement result of this processing unit is reflected in the scene overall judgement.

Test Measurement (Label Data)

The following contents are displayed as text in the "Detail result" area.

Displayed items	Description
Judge	Judgement result
Area	Area
Gravity X	Gravity X
Gravity Y	Gravity Y

Measurement Results for Which Output Is Possible (Label Data)

The following values can be output using processing items related to results output. It is also possible to reference measurement values from expressions and other processing units.

Measurement items	Character string	Description
Judgement	JG	Judgement result
Label No.	LN	Label No.
Area	AR	Area
Gravity X-coordinate	X	Center of gravity X position
Gravity Y-coordinate	Y	Center of gravity Y position

Labeling+

This is a processing item for just FZ3-H □□□ series high grade controllers.
You can binarize the image and extract and count such feature quantities as the area of the white section or find such feature quantities as the area of the specified label number.

Used in the Following Case

- To measure any of 20 or more feature quantities, such as region quantity or circularity

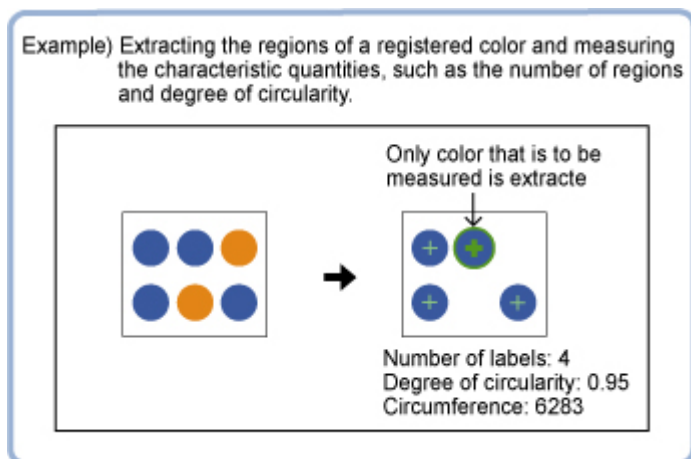

Important

- When FZ3-H □□□ series dedicated processing items are used, processing is carried out that reduces the processing time from the second time on. Therefore, when measuring the same image, the processing for the first time after the controller is started up may be longer than the processing time from the second time on.

Settings Flow (Labeling+)

Labeling+ can be set up as follows.

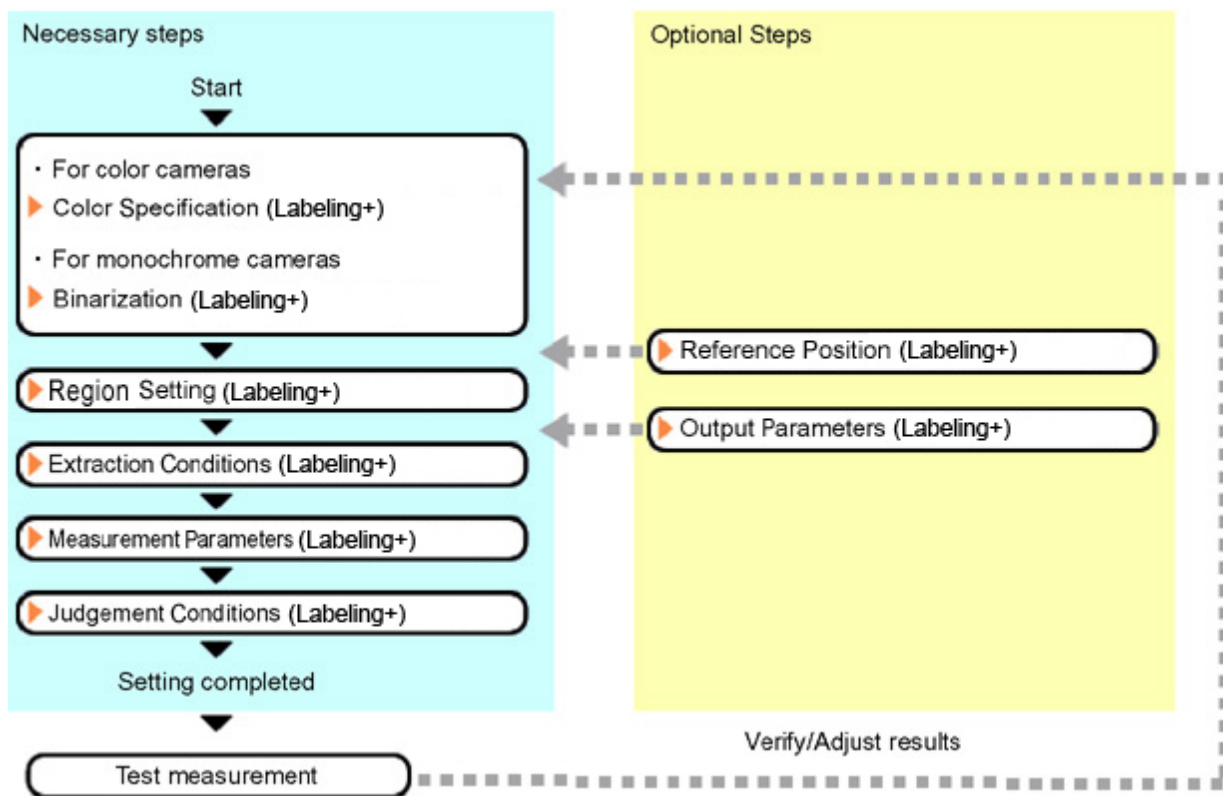

List of Labeling+ Items

Item name	Description
Color (for color cameras only)	This item selects the color whose area and center of gravity are to be measured. Since the color hue, color saturation, and brightness can be selected, then fine-tuning can be performed to colors. Reference: ▶ Color Specification (Labeling+) (p.200)
Binary (for monochrome cameras only)	This item specifies the binary level for converting 256-tone grayscale images input from the camera into binary images. Converted white pixels are measured. Adjust the binary level so that the measurement object is converted to white pixels. Reference: ▶ Binarization (Labeling+) (p.202)
Region setting	This item is used to set up the measurement area. While the input image can be measured as a whole, a quick and reliable measurement can be performed by set up the measured range. Reference: ▶ Region Setting (Labeling+) (p.204)
Ref. position	This item can be changed if necessary. Usually, the central position of the registered region is registered as the reference position. Reference: ▶ Reference Position (Labeling+) (p.205)
Extraction	Specify the feature to extract. Reference: ▶ Extraction Conditions (Labeling+) (p.206)
Measurement	Set the labeling conditions. Specify the labeling processing, number of labels and sorting conditions. Measurement parameter can be changed as needed to address unstable measurement results or to increase the processing speed. Normally, the factory default value will be used. Reference: ▶ Measurement Parameters (Labeling+) (p.208)
Judgement	This item specifies the judgement condition for measurement results. Reference: ▶ Judgement Conditions (Labeling+) (p.212)

Output parameter	This item can be changed if necessary. Normally, the factory default value may be used. Use the output parameter to specify how to handle the coordinates. Reference: ▶ Output Parameters (Labeling+) (p.213)
------------------	---

Color Specification (Labeling+)

When connecting a color camera, specify the color to be measured. There are two specification methods: specifying the color to be extracted in the image or specifying the color with the hue, saturation, and brightness values.

This section describes how to specify colors in an image and gives an example of the procedure for finely adjusting with numeric input afterwards.

1. In the Item Tab area, tap [Color].
2. Place a check at [Auto setting].
3. In the Image Display area, specify the color range you want to detect by dragging the cursor from the upper left corner to the lower right corner of that area.
The color of the specified area is automatically set.

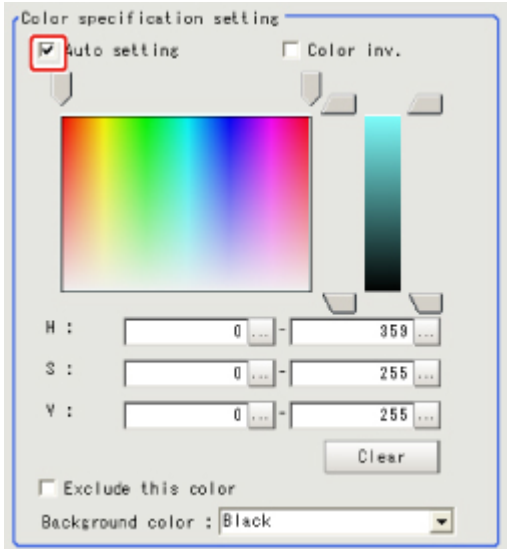

4. Finely adjust the hue, saturation, and brightness if necessary.
Adjust either by adjusting on the color chart or by inputting numbers.

Item	Set value [Factory default]	Description
H	0 to 359	Specify the color phase (difference of color hues).
S	0 to 255	Specify color saturation (difference of color saturation).
V	0 to 255	Specify the brightness (difference of brightness).
Auto setting	<ul style="list-style-type: none"> • Checked • [Unchecked] 	Specifying the color to be measured on the image automatically sets the hue, saturation, and brightness.
Color inv.	<ul style="list-style-type: none"> • Checked • [Unchecked] 	Everything other than the specified color becomes the measurement target.

About color charts

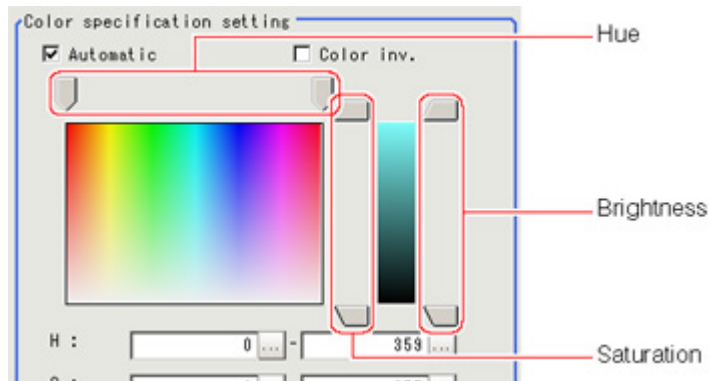

5. To specify multiple colors, place a check at "More ranges of color extraction".



Setting item	Set value [Factory default]	Description
More ranges of color extraction	<ul style="list-style-type: none"> Checked [Unchecked] 	If you place a check at this option, you can set up to 8 colors.

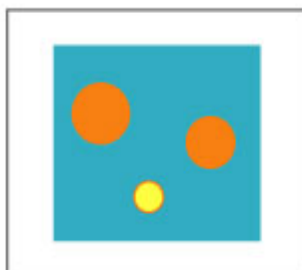

Extract image (before specifying colors)

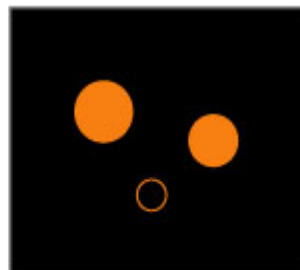

Extract image (after specifying colors - background color:black)

6. If necessary, set the display conditions for displayed images.



Setting item	Set value [Factory default]	Description
Exclude this color	<ul style="list-style-type: none"> Checked [Unchecked] 	If you place a check at this option, pixels within the HSV range are excluded from color extraction. The priority order for exclusion is that the higher color extraction range numbers are given priority. This setting is disabled if "More ranges of color extraction" is unchecked.

BG color	<ul style="list-style-type: none"> • [Black] • White • Red • Green • Blue 	The background section outside the extracted image is filled with the specified colors.
Image kind	<ul style="list-style-type: none"> • Measurement image • [All color image] • Selection color image • Binary image 	This sets the state of the image to display.

Binarization (Labeling+)

When a monochrome camera is connected, the 256-tone grayscale images taken in from the camera are converted into binary black-and-white images before the images are measured. Converted white pixels are measured.

This specifies the level for converting grayscale images into binary images.

1. In the Item Tab area, tap [Binary].
2. In the "Binary kind" area, set the type of binarization.

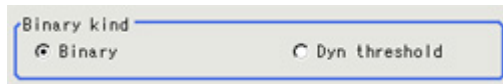

Setting item	Set value [Factory default]	Description
Binary kind	[Binary]	Convert 256-grayscale images to binary images. The binary level that is the conversion threshold is held constant.
	Dyn threshold	The binary level is not held constant. Stable binary images can be obtained by taking the difference between the input image and that input image after it has been subject to brightness averaging. This option is effective when the lighting is unstable.

3. In the "Binary setting" area, specify the reference density range.
When binarization is selected

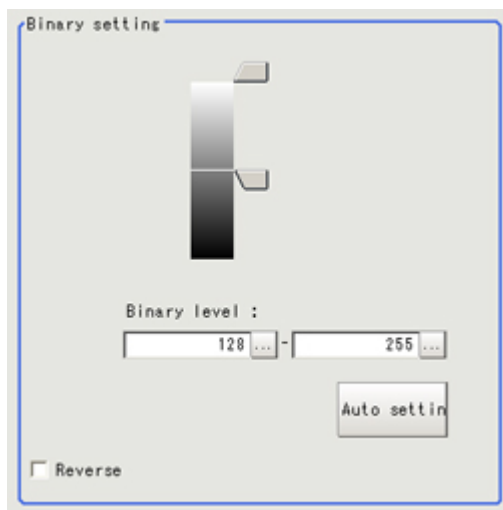

Setting item		Set value [Factory default]	Description
Binary level	Upper limit	0 to 255 [255]	Specify the level for converting 256-tone grayscale images to binary images. Adjust the binary level so that the measurement object is converted to white pixels. You can also set the binary level so that only intermediate density is measured.
	Lower limit	0 to 255 [128]	
Auto setting		-	Optimum binary levels are calculated automatically and set.
Reverse		<ul style="list-style-type: none"> • Checked • [Unchecked] 	This item reverses black and white colors.

When Dyn threshold is selected

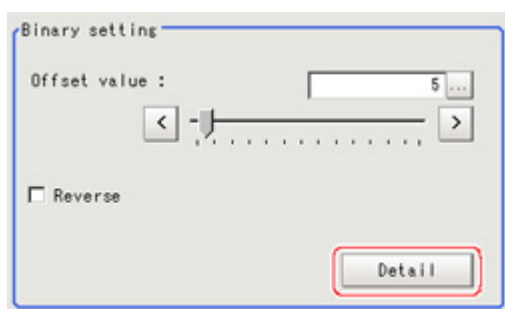

Setting item		Set value [Factory default]	Description
Offset value		0 to 127 [5]	This sets the offset for the difference between the input image and that input image after it has been subject to brightness averaging. The higher this value, the easier it is to extract locations (such as edges) with large density difference.
Reverse		<ul style="list-style-type: none"> • Checked • [Unchecked] 	This item reverses black and white colors.

Perform the [Detail setting] if required.

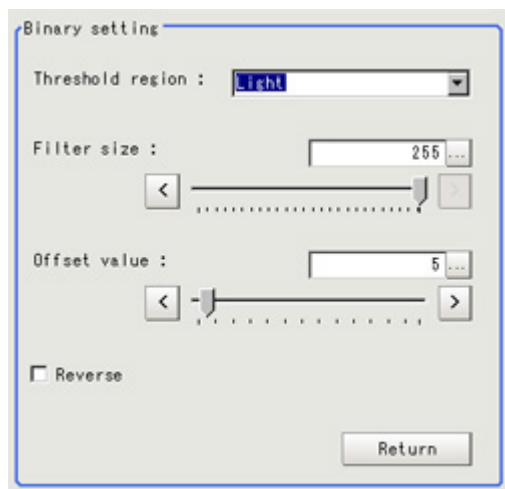

Setting item	Set value [Factory default]	Description
Threshold region	<ul style="list-style-type: none"> • [Light] • Dark • Equal • Not equal 	Set the region to extract. Light: Pixels brighter than the pixels around them are treated as white pixels. Dark: Pixels darker than the pixels around them are treated as white pixels. Equal: Pixels with minimum density difference from the pixels around them are treated as white pixels. Not equal: Pixels with large density difference from the pixels around them are treated as white pixels.
Filter size	3 to [255]	Specify the filter size for brightness averaging processing. Match this size to the size of the location you want to extract.
Offset value	0 to 127 [5]	This sets the offset for the difference between the input image and that input image after it has been subject to brightness averaging. The higher this value, the easier it is to extract locations (such as edges) with large density difference.
Reverse	<ul style="list-style-type: none"> • Checked • [Unchecked] 	This item reverses black and white colors.

Region Setting (Labeling+)

This item is used to set up the measurement area. It is possible to measure the entire input image, but restricting the range enables accurate measurement in a short period of time.

Use a rectangle, straight line, circle (ellipse), wide circle, or polygon to specify a measurement region for [Labeling+].

1. In the Item Tab area, tap [Region setting].
2. Use the Drawing tools to specify the measurement region.

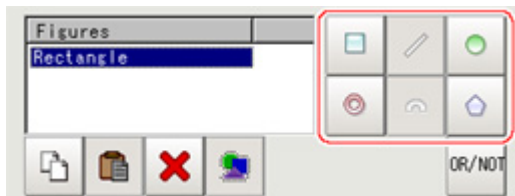

3. In the figure setting area, specify a region to be measured.
4. In the figure setting area, tap [OK].
The measurement region is registered and displayed in the Image Display area.

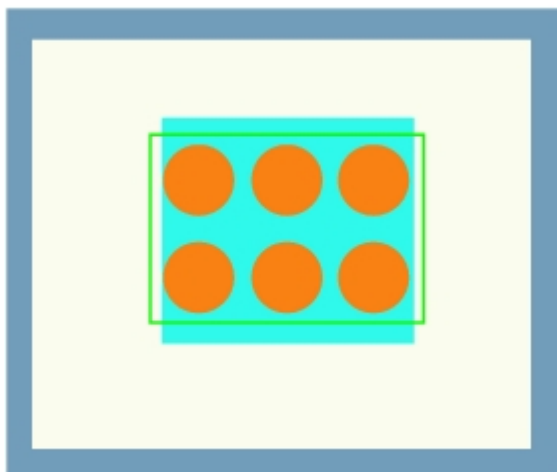

- If necessary, in the "Display setting" area, set up display settings for the images displayed in the Image Display area.

For color cameras:

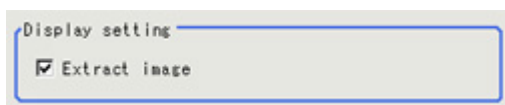

Setting item	Set value [Factory default]	Description
Extract image	<ul style="list-style-type: none"> • [Checked] • Unchecked 	If you place a check at this option, images set with color specification are displayed.

For monochrome cameras:

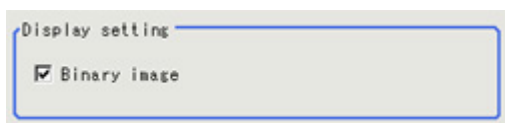

Setting item	Set value [Factory default]	Description
Binary image	<ul style="list-style-type: none"> • [Checked] • Unchecked 	The image is displayed in binary with black and white.

Reference Position (Labeling+)

This item can be changed if necessary. When the region is set, the reference position is automatically set at the center of gravity of the measurement region. In the same way for the reference area, when the region settings are made, they are set automatically based on the measurement region.

This item can be used to change the reference position to any desired position.

- In the Item Tab area, tap [Ref. position].
In the Image Display area, the current reference position will be displayed as the crosshair cursor.
- Tap the position to be set as the reference position.

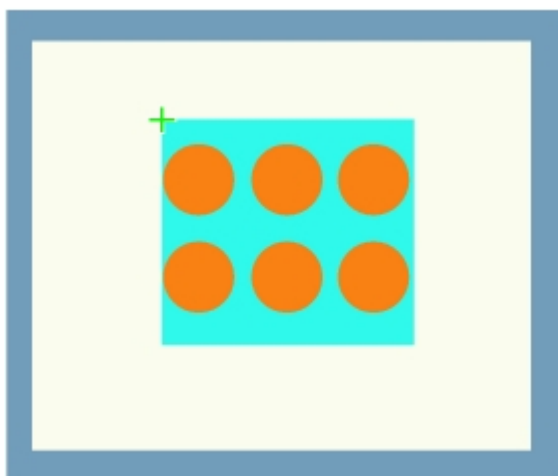

Note

- Displaying the image enlarged makes this tapping easier.
Reference: ▶ "Using the Zoom Function" in the "User's Manual" (p.347)

3. If necessary, finely adjust with numeric input and the arrow buttons.
When changing the registered angle, adjust the reference angle.

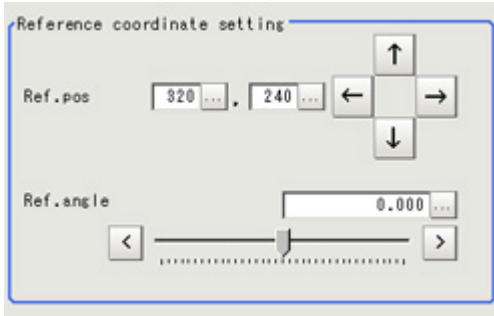

4. If necessary, in the "Display setting" area, set up display settings for the images displayed in the Image Display area.

For color cameras:

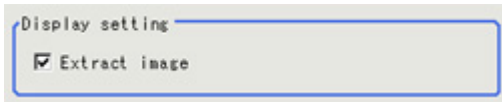

Setting item	Set value [Factory default]	Description
Extract image	<ul style="list-style-type: none"> · [Checked] · Unchecked 	If you place a check at this option, images set with color specification are displayed.

For monochrome cameras:

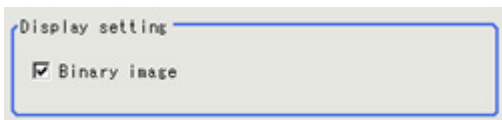



Setting item	Set value [Factory default]	Description
Binary image	<ul style="list-style-type: none"> · [Checked] · Unchecked 	The image is displayed in binary with black and white.

Extraction Conditions (Labeling+)

Set the conditions for extraction as a label. Extraction conditions can be changed as needed to address unstable measurement results or for faster processing. Normally, the factory default value will be used.

1. In the Item Tab area, tap [Extraction].
2. Set the value of each item in the "Filtering" area.

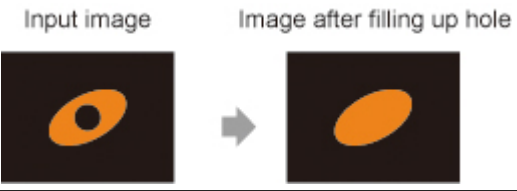

Setting item	Set value [Factory default]	Description
Filling up holes	<ul style="list-style-type: none"> • Checked • [Unchecked] 	<p>Select the process method for the part encircled by the designated color circle.</p> <p>When checked, the hole is processed as having the specified color.</p> 
Outside trimming	<ul style="list-style-type: none"> • Checked • [Unchecked] 	<p>This option can be used only when there is a section of the designated color in the measurement region that does not need to be measured.</p> <p>When "Checked" is set, the whole area outside of the measurement region is extracted as having the specified color.</p>  <p>When calculating the position and area of this label</p> <p>The area outside of the measurement region turns the color of the measurement target. Sort mode: Area descending Label No.: 1 With the settings above, the position and area of the middle label will be measured.</p>

3. If necessary, set the conditions for extraction as a label.

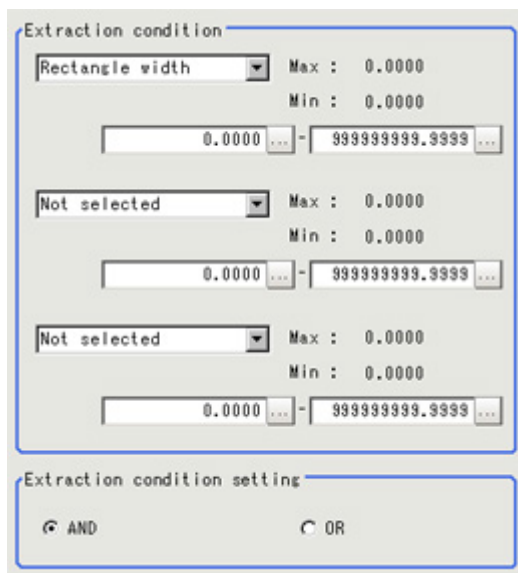

Setting item	Set value [Factory default]	Description
Extraction condition	<ul style="list-style-type: none"> • [Not selected] • Area • Gravity X • Gravity Y • Elliptic axis angle • Elliptic major axis • Elliptic minor axis • Elliptic ratio • Rectangle width • Rectangle height • Rectangle X1 • Rectangle Y1 • Perimeter • Circularity • Fit rect major axis • Fit rect minor axis • Inscribed circle R • Circum. circle R • Number of holes 	Set the extraction conditions.
Extraction condition setting	<ul style="list-style-type: none"> • [AND] • OR 	Set the "Extraction conditions". AND: When all the set "Extraction conditions" are fulfilled. OR: When any of the set "Extraction conditions" is fulfilled.

Note

Circularity

Circularity is a parameter that shows the degree of circularity of a label. It has the following properties.

- The circularity is a value from 0 to 1.
- The closer the label is to a circle, the closer its circularity is to 1.

4. When the setting has been changed, tap [Measurement] in the Detail area to verify whether measurements can be made correctly.



Measurement Parameters (Labeling+)

Set the labeling conditions. Specify the labeling processing, number of labels and sorting conditions. Measurement parameter can be changed as needed to address unstable measurement results or to increase the processing speed. Normally, the factory default value will be used.

1. In the Item Tab area, tap [Measurement].
2. If necessary, in the "Labeling condition" area, specify a value for each item.
When labeling processing is set to be performed, the feature quantities are measured for each extracted label. When labeling processing is set to not be performed, the feature quantities are measured treating all the extracted labels as one label.



When labeling processing is set to be performed, the following items are set.

When the Sort Condition is other than gravity XY, Inscribed circle XY and Circum. circle XY

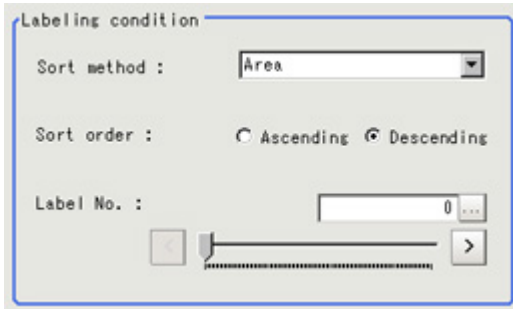

Setting item	Set value [Factory default]	Description
Sort method	<ul style="list-style-type: none"> • [Area] • Gravity X • Gravity Y • Gravity XY • Elliptic axis angle • Elliptic major axis • Elliptic minor axis • Elliptic ratio • Rectangle width • Rectangle height • Rectangle X1 • Rectangle Y1 • Perimeter • Circularity • Fit rect major axis • Fit rect minor axis • Fit rect ratio • Inscribed circle X • Inscribed circle Y • Inscribed circle XY • Inscribed circle R • Circum. circle X • Circum. circle Y • Circum. circle XY • Circum. circle R • Number of holes 	<p>Specify the conditions by which label number is re-assigned.</p> <p>The label number is assigned according to the value of the selected feature quantity.</p> <p>When gravity XY, Inscribed circle XY, or Circum. circle XY is selected, grouping is performed in the vertical or horizontal direction and labels re-assigned within those groups.</p> <p>This is used for assigning numbers to labels lined up in a grid.</p>
Sort order	<ul style="list-style-type: none"> • Ascending • [Descending] 	<p>Set the direction for sorting.</p> <p>Ascending: Numbers are assigned from smaller values to larger.</p> <p>Descending: Numbers are assigned from larger values to smaller.</p>
Label No.	[0] to 2499	Input the label number for the data to be output.

When the sort condition is gravity XY, Inscribed circle XY, or Circum. circle XY (condition with Advanced setting pressed)



Setting item	Set value [Factory default]	Description
Sort method	<ul style="list-style-type: none"> • Area • Gravity X • Gravity Y • Gravity XY • Elliptic axis angle • Elliptic major axis • Elliptic minor axis • Elliptic ratio • Rectangle width • Rectangle height • Rectangle X1 • Rectangle Y1 • Perimeter • Circularity • Fit rect major axis • Fit rect minor axis • Fit rect ratio • Inscribed circle X • Inscribed circle Y • Inscribed circle XY • Inscribed circle R • Circum. circle X • Circum. circle Y • Circum. circle XY • Circum. circle R • Number of holes 	<p>Specify the conditions by which label number is re-assigned.</p> <p>The label number is assigned according to the value of the selected feature quantity.</p> <p>When gravity XY, Inscribed circle XY, or Circum. circle XY is selected, grouping is performed in the vertical or horizontal direction and labels re-assigned within those groups.</p> <p>This is used for assigning numbers to labels lined up in a grid.</p>
Sort kind	<ul style="list-style-type: none"> • Col sort • [Row sort] 	<p>Selects the axis for grouping.</p> <p>When Col sort is selected, groups are made along the Y axis.</p> <p>When Row sort is selected, groups are made along the X axis.</p>

Row order(Y dir.)	<ul style="list-style-type: none"> Ascending [Descending] 	<p>Specifies the axis for ordering groups.</p> <p>Ascending: Numbers are assigned from groups with smaller Y coordinates.</p> <p>Descending: Numbers are assigned from groups with larger Y coordinates.</p> <p>When Row sort is selected, group numbers are assigned along the X axis according to the column sequence.</p>
Sort order(X dir.)	<ul style="list-style-type: none"> Ascending [Descending] 	<p>Specifies the axis for assigning numbers to labels within groups.</p> <p>Ascending: Numbers are assigned from labels in the group with smaller X coordinates.</p> <p>Descending: Numbers are assigned from labels in the group with larger X coordinates.</p> <p>When Row sort is selected, label numbers are assigned are along the Y axis.</p>
Label No.	0 to 2499	Input the label number for the data to be output.

Set details as necessary.

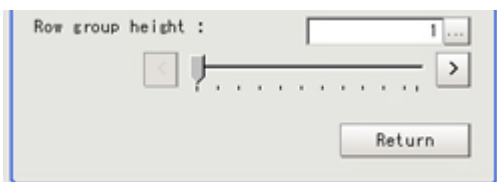

Setting item	Set value [Factory default]	Description
Row group height	1 to 255 [1]	<p>Input the length for making groups.</p> <p>If separate labels are present within the group length of an individual label position, they are put in the same group.</p> <p>When Row sort is selected, if separate labels are present within the group width, they are put in the same group.</p>

3. If necessary, set the drawing setting values.

When the Sort Condition is other than center of gravity XY, Inscribed circle XY and Circum. circle XY

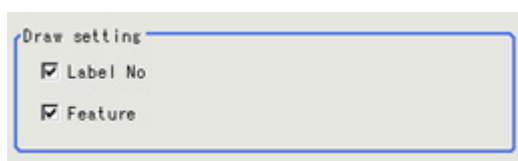

When the Sort Condition is gravity XY, Inscribed circle XY and Circum. circle XY



Setting item	Set value [Factory default]	Description
Label No.	<ul style="list-style-type: none"> • [Checked] • Unchecked 	Place a check here to display label numbers.
Feature	<ul style="list-style-type: none"> • [Checked] • Unchecked 	When checked, the feature quantities selected for judgement condition display are displayed on the image. When the feature quantity is number of labels, area, center of gravity, Perimeter, circularity, or number of holes, it is not displayed.
Row/Col group	<ul style="list-style-type: none"> • [Checked] • Unchecked 	Place a check here to display the line/column region.

Judgement Conditions (Labeling+)

1. In the Item Tab area, tap [Judgement].
2. If necessary, specify a value for each item.
To set feature quantities 4-7, tap the [Feature data4-7] button.

Judgement target

All labels Selected label

Judgement

0. Number of labels Value : 0.0000
Max : 0.0000
 Display Min : 0.0000
0.0000 - 99999999.9999

1. Not selected Value : 0.0000
Max : 0.0000
 Display Min : 0.0000
0.0000 - 99999999.9999

2. Not selected Value : 0.0000
Max : 0.0000
 Display Min : 0.0000
0.0000 - 99999999.9999

3. Not selected Value : 0.0000
Max : 0.0000
 Display Min : 0.0000
0.0000 - 99999999.9999

Feature data0-3 Feature data4-7

Setting item	Set value [Factory default]	Description
<ul style="list-style-type: none"> Judgement target 	<ul style="list-style-type: none"> All labels [Selected label] 	<p>Specify the labels to be targeted.</p> <p>When "Selected label" is selected, only labels specified by number are judged.(However, when Judgement condition is Number of labels, it is not applied.)</p> <p>When "All labels" is selected, all extracted labels are judged.</p>
<ul style="list-style-type: none"> Judgement 	<p>0.000 to 9999999.999</p>	<p>Set up the judgement condition.</p>
<ul style="list-style-type: none"> [Not selected] Number of labels Area Gravity X Gravity Y Elliptic axis angle Elliptic major axis Elliptic minor axis Elliptic ratio Rectangle width Rectangle height Rectangle X1 Rectangle Y1 Perimeter Circularity Fit rect major axis Fit rect minor axis Fit rect ratio Inscribed circle X Inscribed circle Y Inscribed circle R Circum. circle X Circum. circle Y Circum. circle R Number of holes 		
Display radio buttons	[Judgement 0]	Specify the feature quantities displayed on the image.

Output Parameters (Labeling+)

Specify how to treat the coordinates to be output to the external device as measurement results. This item can be changed if necessary. Normally, the factory default value will be used.

Important

- After setting up the measurement parameters, changing the output parameters will cause measurement results to vary accordingly. If the output parameters have been changed, re-specify the measurement, too.

- Tap [Output parameter] in the Item Tab area.

2. Specify each of the following items.

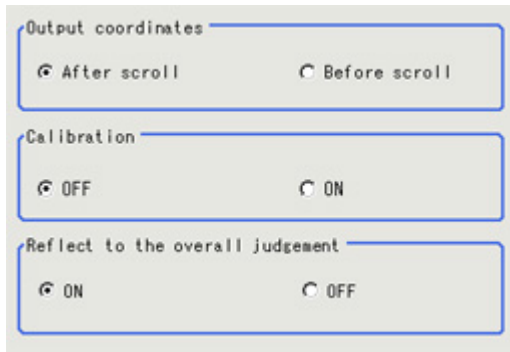

Setting item	Set value [Factory default]	Description
Output Coordinates	<ul style="list-style-type: none"> · [After scroll] · Before scroll 	As measurement results, select whether to output coordinate values to external devices before or after the position deflection correction is applied.
Calibration	<ul style="list-style-type: none"> · [OFF] · ON 	Select whether to reflect the calibration in the values output to the external device as measurement results. ON: Output the coordinates converted into actual dimensions. OFF: Output the camera coordinate values.
Reflect to overall judgement	<ul style="list-style-type: none"> · [ON] · OFF 	Enables choosing whether or not the judgement result of this processing unit is reflected in the scene overall judgement.

Key Points for Test Measurement and Adjustment (Labeling+)

In addition to the judgement, the contents of feature quantities 0-7 specified with the judgement condition tab are displayed in the "Detail result" area.

Displayed items	Description
Judge	Judgement result

Key Points for Adjustment

Select the adjustment method referring to the following points.

When the measurement results are too unstable for extraction

For color cameras:

Parameter to be adjusted	Remedy
Color	Tap the area whose color will be sampled and the area whose color will not be sampled. The setup should be such that two stable sections of hue, saturation and brightness are formed. Or place a check at More ranges of color extraction and multiple colors are specified.

For monochrome cameras:

Parameter to be adjusted	Remedy
Binary	Adjust the binary level.

Measurement Results for Which Output Is Possible (Labeling+)

The following values can be output using processing items related to results output. It is also possible to reference measurement values from expressions and other processing units.

Measurement items	Character string	Description
Judgement	JG	Judgement result
Number of labels	L	Number of labels
Gravity X	X	Gravity X
Gravity Y	Y	Gravity Y
Reference position X	SX	Reference position X coordinate
Reference position Y	SY	Reference position Y coordinate
Reference angle	ST	Reference angle
Feature data0	FDA	Feature quantity 0 for the label specified with the judgement conditions
Feature data1	FDB	Feature quantity 1 for the label specified with the judgement conditions
Feature data2	FDC	Feature quantity 2 for the label specified with the judgement conditions
Feature data3	FDD	Feature quantity 3 for the label specified with the judgement conditions
Feature data4	FDE	Feature quantity 4 for the label specified with the judgement conditions
Feature data5	PDF	Feature quantity 5 for the label specified with the judgement conditions
Feature data6	FDG	Feature quantity 6 for the label specified with the judgement conditions
Feature data7	FDH	Feature quantity 7 for the label specified with the judgement conditions
Feature data0 [0]	FDA0	Feature quantity 0 [Label 0]
Feature data1 [0]	FDB0	Feature quantity 1 [Label 0]
Feature data2 [0]	FDC0	Feature quantity 2 [Label 0]
Feature data3 [0]	FDD0	Feature quantity 3 [Label 0]
Feature data4 [0]	FDE0	Feature quantity 4 [Label 0]
Feature data5 [0]	PDF0	Feature quantity 5 [Label 0]
Feature data6 [0]	FDG0	Feature quantity 6 [Label 0]
Feature data7 [0]	FDH0	Feature quantity 7 [Label 0]
Feature data0 [1]	FDA1	Feature quantity 0 [Label 1]
Feature data1 [1]	FDB1	Feature quantity 1 [Label 1]
Feature data2 [1]	FDC1	Feature quantity 2 [Label 1]
Feature data3 [1]	FDD1	Feature quantity 3 [Label 1]
Feature data4 [1]	FDE1	Feature quantity 4 [Label 1]
Feature data5 [1]	PDF1	Feature quantity 5 [Label 1]
Feature data6 [1]	FDG1	Feature quantity 6 [Label 1]

Feature data7 [1]	FDH1	Feature quantity 7 [Label 1]
.	.	.
.	.	.
.	.	.
Feature data0 [99]	FDA99	Feature quantity 0 [Label 99]
Feature data1 [99]	FDB99	Feature quantity 1 [Label 99]
Feature data2 [99]	FDC99	Feature quantity 2 [Label 99]
Feature data3 [99]	FDD99	Feature quantity 3 [Label 99]
Feature data4 [99]	FDE99	Feature quantity 4 [Label 99]
Feature data5 [99]	PDF99	Feature quantity 5 [Label 99]
Feature data6 [99]	FDG99	Feature quantity 6 [Label 99]
Feature data7 [99]	FDH99	Feature quantity 7 [Label 99]

Defect

Detect defects and contamination using color variation within the measurement region. This is real color processing, so even if defect and contamination colors change or the background color changes, stable inspection is possible.

Used in the Following Case

- Detecting defects, contaminations and spots on plain measurement objects

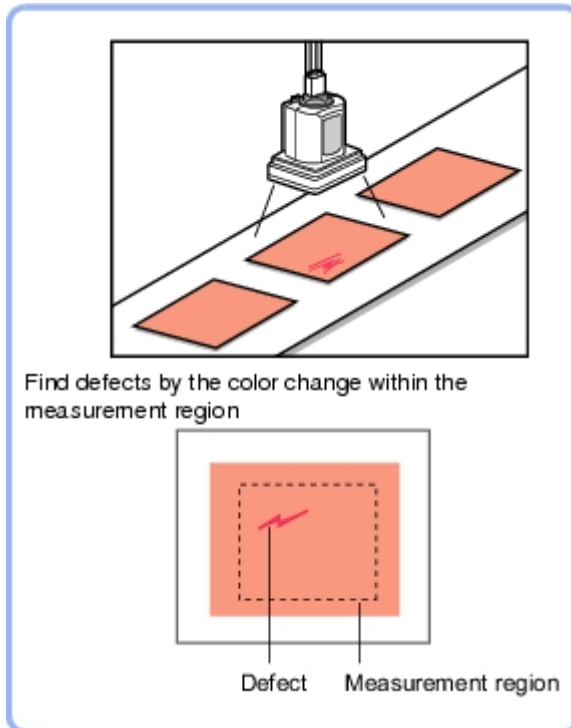

- Measure appearance defects and defects of parts

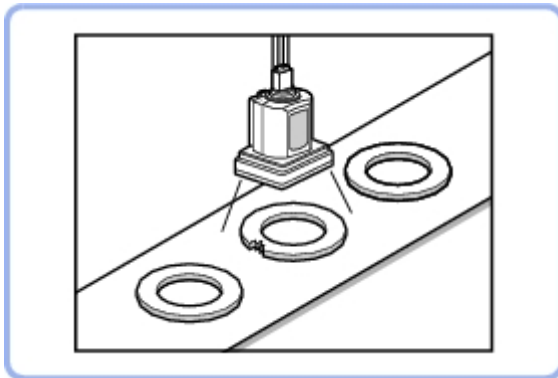

Note

- With Defect, defects and contamination on patterns and characters can not be detected.

Settings Flow (Defect)

Make the defect/contamination settings with the following flow.

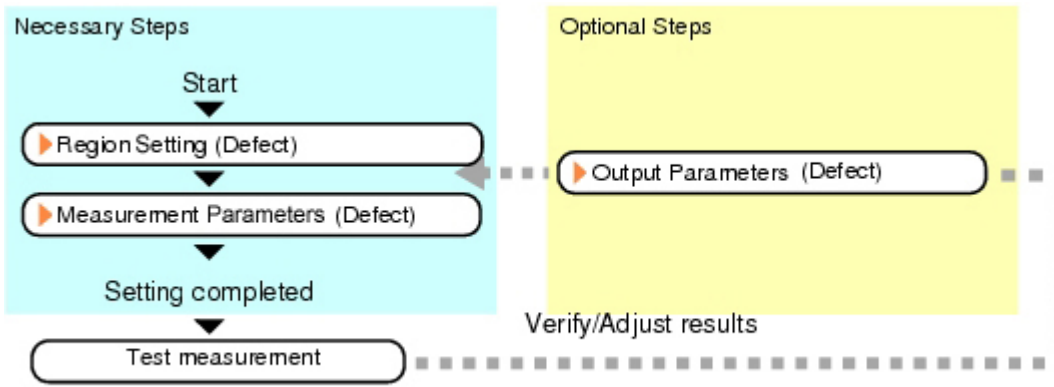

List of Defect Items

Item name	Description
Region setting	This item is used to set up the measurement area. Instead of measuring the entire input image, narrowing the measurement area shortens the processing time. Reference: ▶ Region Setting (Defect) (p.218)
Measurement	This item specifies the judgement condition for measurement results. Measurement parameter can be changed as needed to address unstable measurement results or to increase the processing speed. Normally, the factory default value will be used. Reference: ▶ Measurement Parameters (Defect) (p.219)
Output parameter	This item can be changed if necessary. Normally, the factory default value will be used. Use the output parameter to specify how to handle the coordinates. Reference: ▶ Output Parameters (Defect) (p.223)

Region Setting (Defect)

This item is used to set up the measurement area.

Use a rectangle, wide line, ellipse (circle), wide circle, wide arc or polygon to specify a measurement region for [Defect]. Up to 8 figures can be drawn.

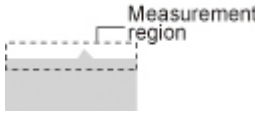
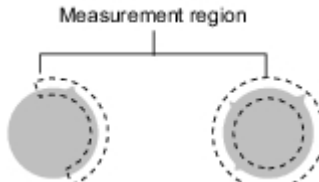
PT	Description
Wide line	Selected when detecting defects and burrs of the measurement objects. 
Wide circle, wide arc	Selected when detecting defects and burrs of the circle measurement objects. 

Rectangle, ellipse (circle), polygon

Selected when detecting the overall defects of specified zones and measurement objects.

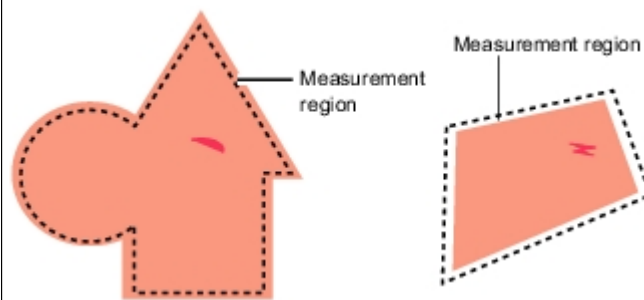

1. In the Item Tab area, tap [Region setting].
2. Use the Drawing tools to specify the measurement region.
Up to 8 figures can be combined.

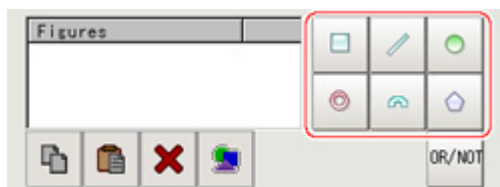

3. In the figure setting area, tap [OK].
The measurement region is registered and displayed in the Image Display area.

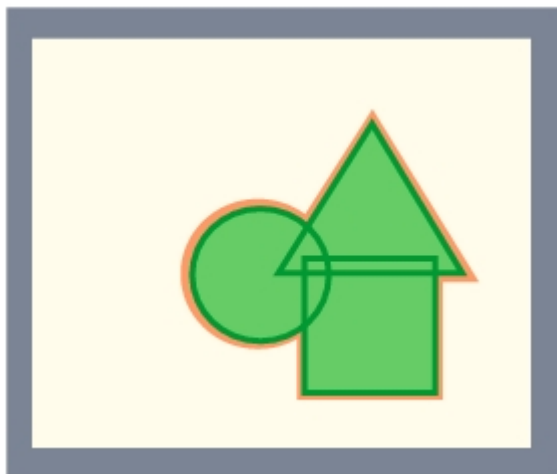

Measurement Parameters (Defect)

This item specifies the judgement condition for measurement results. Measurement parameters can be changed as needed to address unstable measurement results or to increase the processing speed.

Note

Defect detection mechanism

- After measurement region is drawn, a rectangle (defect detection region) is automatically formed in this region. While moving the defect detection region around, calculate the RGB color averages at each location and find the defect detection difference with surrounding defects. This difference is called the defect level. Calculate the defect level for all defect detection areas. If the maximum value exceeds the judgement value, it is judged that there are defects in the measurement region.

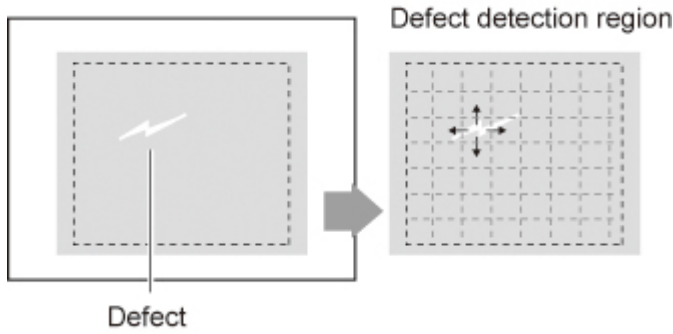

- In the Item Tab area, tap [Measurement].
- Set the value of each item in the "Defect size" area.

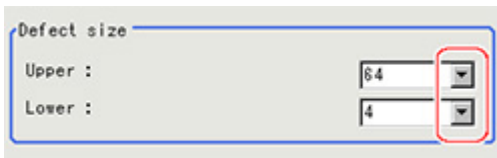

Setting item	Set value [Factory default]	Description
Defect size	<ul style="list-style-type: none"> • 4 • 8 • 12 • 16 • 24 • 32 • [64] [4] to [64]	<p>Specify the upper and lower limits of defect detection size based on the size of scratch or contamination to be detected. A defect detection region is automatically created with the number of pixels for the defects size.</p> <p>The larger the difference between upper and lower limits, the easier to detect defects/contamination of various sizes.</p> <p>For both upper and lower limits, higher values for defect detection size limits leads to weaker detection sensitivity and shorter processing time.</p> <div style="text-align: center;"> <p>Defect detection size</p> </div>

3. If necessary, set the value of each item in the "Measurement parameter" area.
 For color cameras:

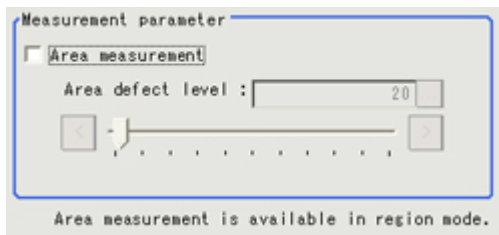

For monochrome cameras:

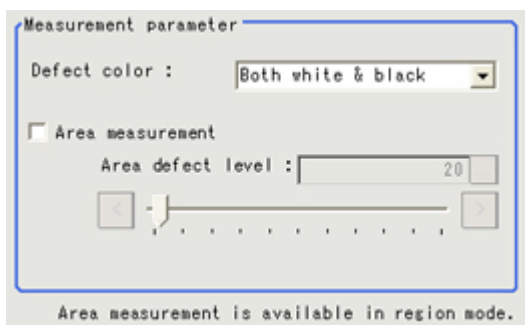

Setting item	Set value [Factory default]	Description
Area measurement	<ul style="list-style-type: none"> • Checked • [Unchecked] 	Place a check when you want to measure the size of defects. This item can divide the high defect detection regions into groups and output the surface and center of gravity coordinates of the group with the largest area. However, when only one region is specified with "Wide line", "Wide circle", or "Arc", area measurement is not possible.
Area defect level	0 to 999 [20]	If you place a check at Area Measurement, set defect level counted in the defect area.
Defect color (for monochrome cameras only)	Black only	Select this value to detect defects that look darker than the background.
	White only	Select this value to detect defects that look lighter than the background.
	[Both white & black]	Select this value when the brightness of defects is not known.

Note

Region inspection mode

- The comparison direction depends on the measurement region shapes and number.
For a rectangle, ellipse or polygon, comparison is with the defect detection regions above, below, left and right. This is called region inspection mode.

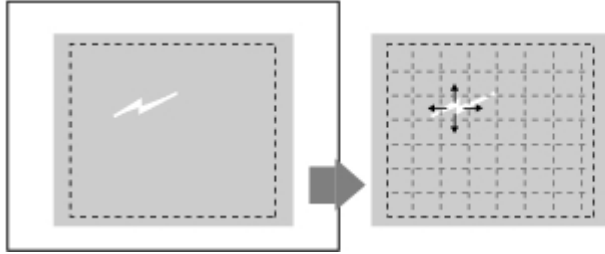

For a wide line, wide arc or wide circle, comparison is only with the two neighboring defect detection regions.

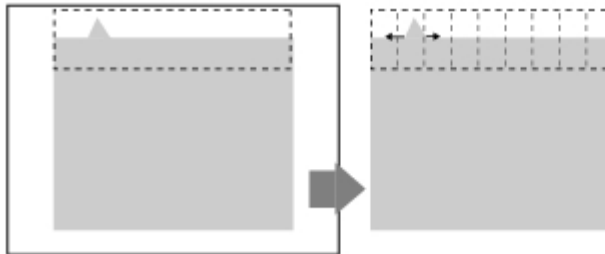

However, even for a wide line, wide arc or wide circle, when two or more figures are drawn, measurement is in region inspection mode.

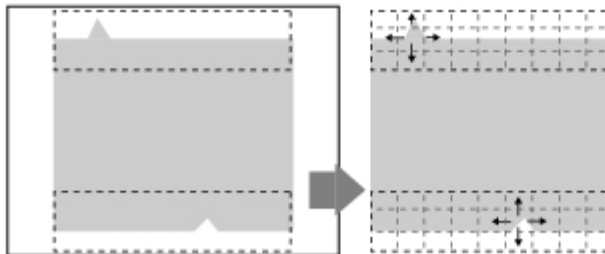

- When the setting has been changed, tap [Measurement] in the Detail area to verify whether measurements can be made correctly.



- Set up the judgement condition.

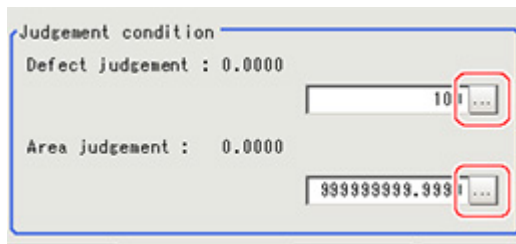

Item	Set value [Factory default]	Description
Defect judgement	0 to 999 [100]	Specify the upper limit for defect judgement. (The lower limit is fixed at 0.) When "30" is set, the OK value should be within the range of 0 to 30.
Area judgement	0 to A_MAX	Specify the maximum defect area. A_MAX: 307,200 for a 0.3-megapixel camera, 1,920,000 for a 2-megapixel camera

Note

- The value beside each item are measurement results of the displayed image. Take these values into consideration to determine the upper and lower limits.

Output Parameters (Defect)

Specifies whether or not the judgement results of this processing unit is reflected in the scene overall judgement.

- Tap [Output parameter] in the Item Tab area.
- Choose whether or not to reflect this in the scene overall judgement in "Reflect to overall judgement" area.



Setting item	Set value [Factory default]	Description
Reflect to overall judgement	<ul style="list-style-type: none"> [ON] OFF 	Enables choosing whether or not the judgement result of this processing unit is reflected in the scene overall judgement.

Key Points for Test Measurement and Adjustment (Defect)

In the "Detail result" area on the Main screen, you can confirm the following contents in text.

Displayed items	Description
Judge	Judgement result
Defect value	Measured defect level
Defect X	X Coordinate of measured defect position
Defect Y	Y coordinate of measured defect position
Area	The measured maximum defect area
Gravity X	Center of gravity X coordinate of the measured maximum defect area
Gravity Y	Center of gravity Y coordinate of the measured maximum defect area

Key Points for Adjustment

Select the adjustment method referring to the following points.

When the measurement results are unstable

Noise is detected as defects.

Parameter to be adjusted	Remedy
Measurement	Specify a larger value for "Defect judgement" in the judgement conditions.

Judgement will be NG.

Parameter to be adjusted	Remedy
Measurement	Make the measurement region larger than the lower limit of the defect size.Or make the lower limit of the defect detection size smaller than the measurement region.

When the processing speed is slow

Parameter to be adjusted	Remedy
Measurement	Specify a larger value for the "Defect size".
	Reduce the difference between the upper and lower limits of "Defect size".

Measurement Results for Which Output Is Possible (Defect)

The following values can be output using processing items related to results output.It is also possible to reference measurement values from expressions and other processing units.

Measurement items	Character string	Description
Judgement	JG	Judgement result
Defect	F	Measured defect level
Position of defect	X	X Coordinate of measured defect position
Position of defect	Y	Y coordinate of measured defect position
Defect area	AR	The measured maximum defect area
Defect gravity	GX	The center of gravity X coordinates of the measured maximum defect area
Defect gravity	GY	The center of gravity Y coordinates of the measured maximum defect area

Precise Defect

Defects and contamination on plain measurement objects can be detected with high precision by performing differential processing on the image. By changing the size of elements used for detection, comparison intervals, etc., fine customization of speed and precision is possible.

Used in the Following Case

- Detecting defects, contaminations and spots on plain measurement objects

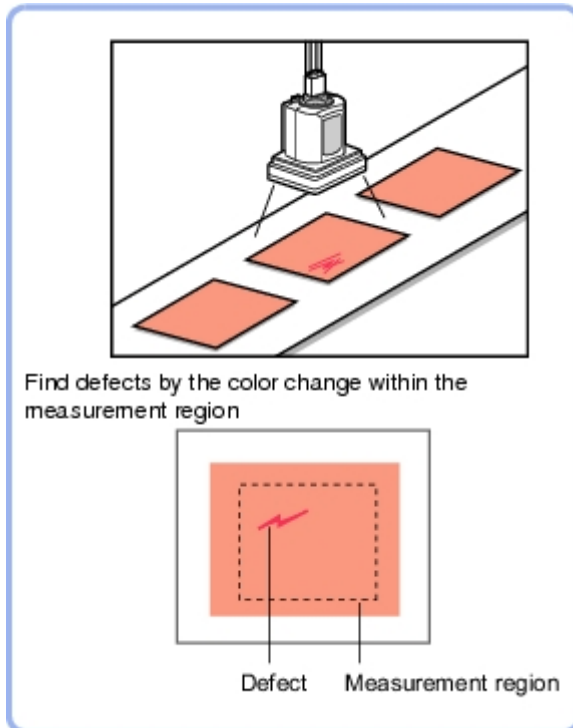

- Measure appearance defects and defects of parts

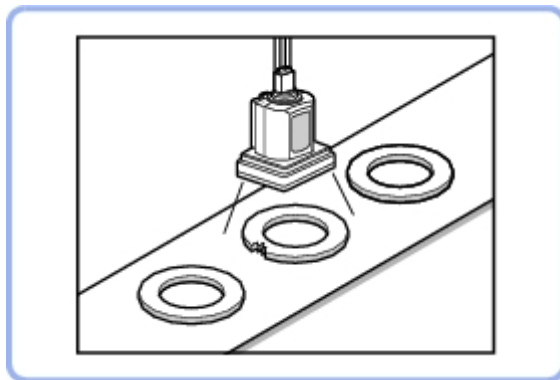

Settings Flow (Precise Defect)

Precise Defect settings are made with the following flow.

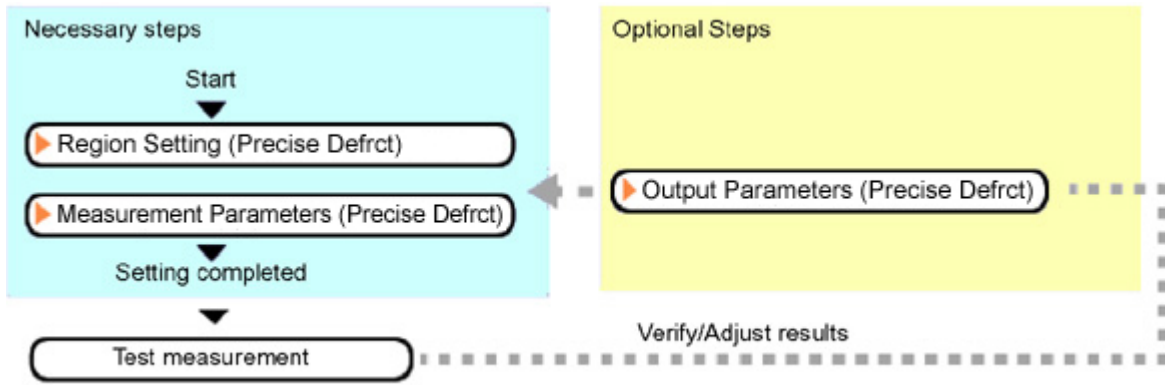

List of Precise Defect Items

Item name	Description
Region setting	This item is used to set up the measurement area. Instead of measuring the entire input image, narrowing the measurement area shortens the processing time. Reference: ▶ Region Setting (Precise Defect) (p.226)
Measurement	This item specifies the judgement condition for measurement results.Measurement parameter can be changed as needed to address unstable measurement results or to increase the processing speed. Normally, the factory default value will be used. Reference: ▶ Measurement Parameters (Precise Defect) (p.227)
Output parameter	This item can be changed if necessary.Normally, the factory default value will be used. Use the output parameter to specify how to handle the coordinates. Reference: ▶ Output Parameters (Precise Defect) (p.231)

Region Setting (Precise Defect)

This item is used to set up the measurement area.

Use a rectangle, wide line, ellipse (circle), wide circle, wide arc or polygon to specify a measurement region for [Precise Defect].Up to 8 figures can be drawn.

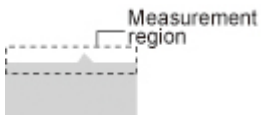
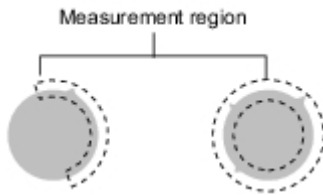
PT	Description
Wide line	Selected when detecting defects and burrs of the measurement objects. 
Wide circle, wide arc	Selected when detecting defects and burrs of the circle measurement objects. 

Rectangle, ellipse (circle), polygon

Selected when detecting the overall defects of specified zones and measurement objects.

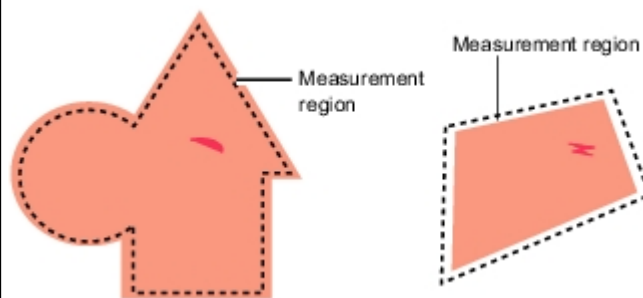

1. In the Item Tab area, tap [Region setting].
2. Use the Drawing tools to specify the measurement region.
Up to 8 figures can be combined.

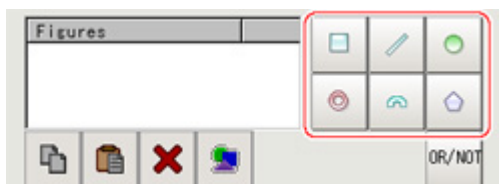

3. In the figure setting area, tap [OK].
The measurement region is registered and displayed in the Image Display area.

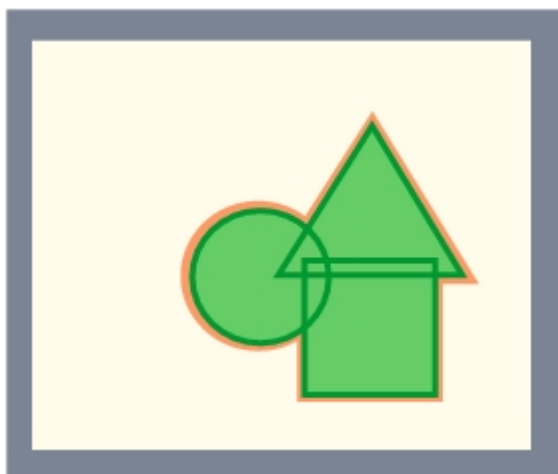

Measurement Parameters (Precise Defect)

This item specifies the judgement condition for measurement results. Measurement parameters can be changed as needed to address unstable measurement results or to increase the processing speed.

1. In the Item Tab area, tap [Measurement].

2. Set the detection parameters.

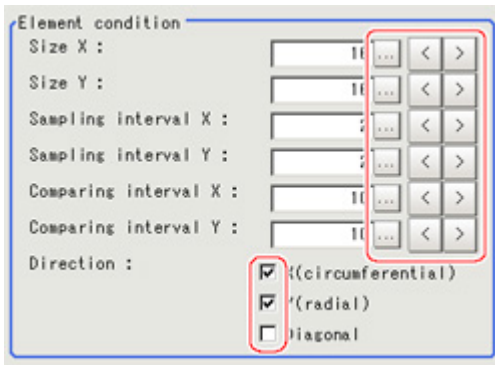

Setting item	Set value [Factory default]	Description
Size X	4 to 64 [16]	Specify the X-axis size of defects/contamination to be detected. The higher this value, the higher the degree of defects for large defects. Specify in units of pixels.
Size Y	4 to 64 [16]	Specify the Y-axis size of defects/contamination to be detected. The higher this value, the higher the degree of defects for large defects. Specify in units of pixels.
Sampling interval X	1 to 64 [2]	Specify the interval for creating elements along the X axis. The smaller this value, the greater the defect detection performance, but the slower the processing speed. Specify in units of pixels.
Sampling interval Y	1 to 64 [2]	Specify the interval for creating elements along the Y axis. The smaller this value, the greater the defect detection performance, but the slower the processing speed. Specify in units of pixels.
Comparing interval X	1 to 32 [10]	Set the number of neighboring elements compared with when the degree of defect is calculated. For example, if the Sampling interval X is set to 4 and the comparing interval X is set to 2, comparison is with separate elements of $4 \times 2 = 8$ pixels along the X axis.
Comparing interval Y	1 to 32 [10]	Set the number of neighboring elements compared with when the degree of defect is calculated. For example, if the sampling interval Y is set to 4 and the comparing interval Y is set to 2, comparison is with separate elements of $4 \times 2 = 8$ pixels along the Y axis.
Direction	<ul style="list-style-type: none"> • X (circumferential) • Y(radial) • Diagonal 	Set the direction for detecting defects. The smaller the direction setting count, the shorter the processing time.

Note

- Measurement mode

In Precise Defect measurement, the measurement mode depends on the number of registered region figures and their types. The way to make elements depends on the measurement mode. The relationship between the figure and measurement mode is as in the table below.

Measurement mode	Single figure						Multiple figures
	Line	Circumference	Arc	Ellipse	Rectangle	Polygon	
Measurement mode	Line	Wide circle and arc	Wide circle and arc	Region	Region	Region	Region

Line mode:

- The direction parallel to the measurement region straight line is the X axis and the direction perpendicular is the Y axis. The shape of elements is rectangular. The element width and length are the number of pixels specified with the element size X and Y.

Wide circle and arc mode:

- The circumferential direction along the measurement region wide circle (arc) is the X axis and the radial direction is the Y axis. The shape of elements is fan-shaped. If the circumference length of the wide circle (arc) of the measurement region is set to N, the element circumferential direction width is $360 \text{ degrees} \times \frac{\text{element size } X}{N}$. The element radial direction width is the number of pixels specified with the element size Y. The element circumferential direction width is defined as an angle, so the closer the element to the outer circumference, the larger the element.

Region mode:

- The direction parallel to the measurement region is the X axis and the direction perpendicular is the Y axis. The shape of elements is rectangular. The element width and length are the number of pixels specified with the element size X and Y.

3. If necessary, set the value of each item in the "Measurement condition" area.

Value input method: Reference: ▶ See the "User's Manual", "Inputting Values" (p.343)

The "Area meas. LV" can be set also by dragging the slider or by tapping the buttons at the ends of the slider.

For color cameras:

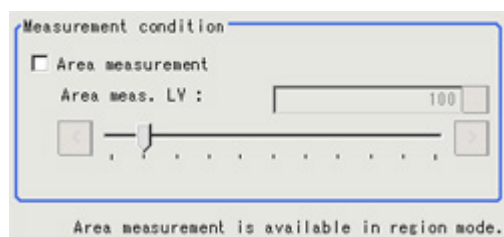

For monochrome cameras:

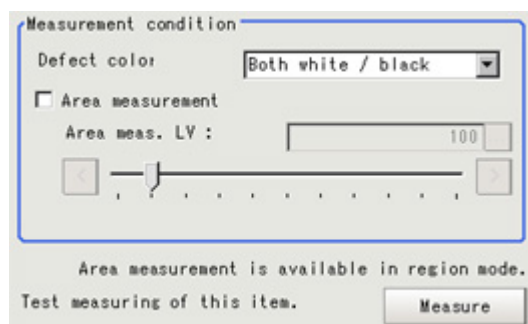

Setting item	Set value [Factory default]	Description
Defect color (for monochrome cameras only)	Black	Select this value when defects look blackish compared to the background.
	White	Select this value when defects look whitish compared to the background.
	[Both white / black]	Select this value when the brightness of defects is not known.
Area measurement	<ul style="list-style-type: none"> · Checked · [Unchecked] 	Place a check when you want to measure the size of defects. This item can divide the high defect detection regions into groups and output the surface and center of gravity coordinates of the group with the largest area. However, when only one region is specified with "Wide line", "Wide circle", or "Arc", area measurement is not possible.
Area meas. LV	0 to 999 [100]	If you place a check at Area Measurement, set defect level counted in the defect area.

- When the setting has been changed, tap [Measurement] in the Detail area to verify whether measurements can be made correctly.



- Set up the judgement condition.

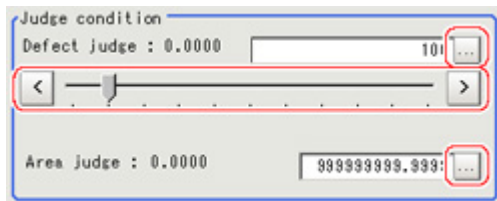

Setting item	Set value [Factory default]	Description
Defect judge	0 to 999 [100]	Specify the upper limit for defect judgement. (The lower limit is fixed at 0.) When "30" is set, the OK value should be within the range of 0 to 30.
Area judge	0 to [999999999.9999]	Specify the maximum defect area. A_MAX: 307,200 for a 0.3-megapixel camera, 1,920,000 for a 2-megapixel camera, 4,320,000 for a 5-megapixel camera

- If necessary, set the display conditions for displayed images.

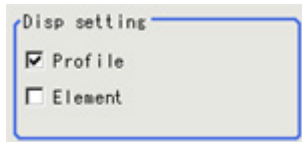

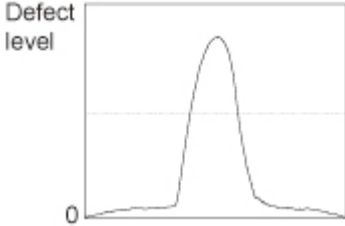
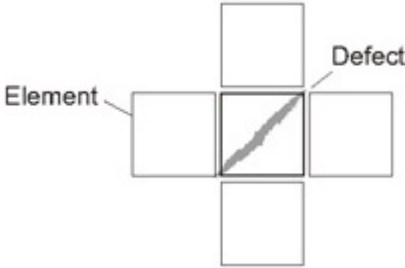
Setting item	Set value [Factory default]	Description
Profile	<ul style="list-style-type: none"> • [Checked] • Unchecked 	<p>Set the profile display.</p>  <p>The maximum degree of defect along the X(circumferential) and Y(radial) is displayed with red lines. If you tap in the measurement region on the image area, the profile in the XY directions from this point is displayed with yellow lines.</p>
Element	<ul style="list-style-type: none"> • Checked • [Unchecked] 	<p>Set the comparison element display. Elements are created automatically during measurement. The density is calculated for each element and the position of defects/contamination is detected from the degree of their variation.</p> 

Output Parameters (Precise Defect)

Specifies whether or not the judgement results of this processing unit is reflected in the scene overall judgement.

1. Tap [Output parameter] in the Item Tab area.
2. Choose whether or not to reflect this in the scene overall judgement in "Reflect to overall judgement" area.



Setting item	Set value [Factory default]	Description
Reflect to overall judgement	<ul style="list-style-type: none"> • [ON] • OFF 	Enables choosing whether or not the judgement result of this processing unit is reflected in the scene overall judgement.

Key Points for Test Measurement and Adjustment (Precise Defect)

The following content is displayed in the "Detail result" area as text.

Displayed items	Description
Judge	Judgement result
Defect value	Measured defect level
Defect X	X Coordinate of measured defect position
Defect Y	Y coordinate of measured defect position
Area	The measured maximum defect area
Gravity X	Center of gravity X coordinate of the measured maximum defect area
Gravity Y	Center of gravity Y coordinate of the measured maximum defect area

Key Points for Adjustment

Select the adjustment method referring to the following points.

When the measurement results are unstable

Noise is detected as defects.

Parameter to be adjusted	Remedy
Measurement	Specify a larger value for "Defect judge" in the judgement conditions.

Judgement will be NG.

Parameter to be adjusted	Remedy
Measurement	Make the measurement region larger than the value of the element size.

When the processing speed is slow

Parameter to be adjusted	Remedy
Measurement	Specify a larger value for the element creation interval.

Measurement Results for Which Output Is Possible (Precise Defect)

The following values can be output using processing items related to results output. It is also possible to reference measurement values from expressions and other processing units.

Measurement items	Character string	Description
Judgement	JG	Judgement result
Defect	F	Measured defect level
Measurement coordinate X	X	X Coordinate of measured defect position
Measurement coordinate Y	Y	Y coordinate of measured defect position
Defect area	AR	The measured maximum defect area
Gravity X	GX	The center of gravity X coordinates of the measured maximum defect area
Gravity Y	GY	The center of gravity Y coordinates of the measured maximum defect area

Fine Matching

Differences can be detected in a fast and highly precise way by overlapping registered fine images with input images (matching).

Used in the Following Case

- To precisely detect trivial defects at the edges of text and patterns

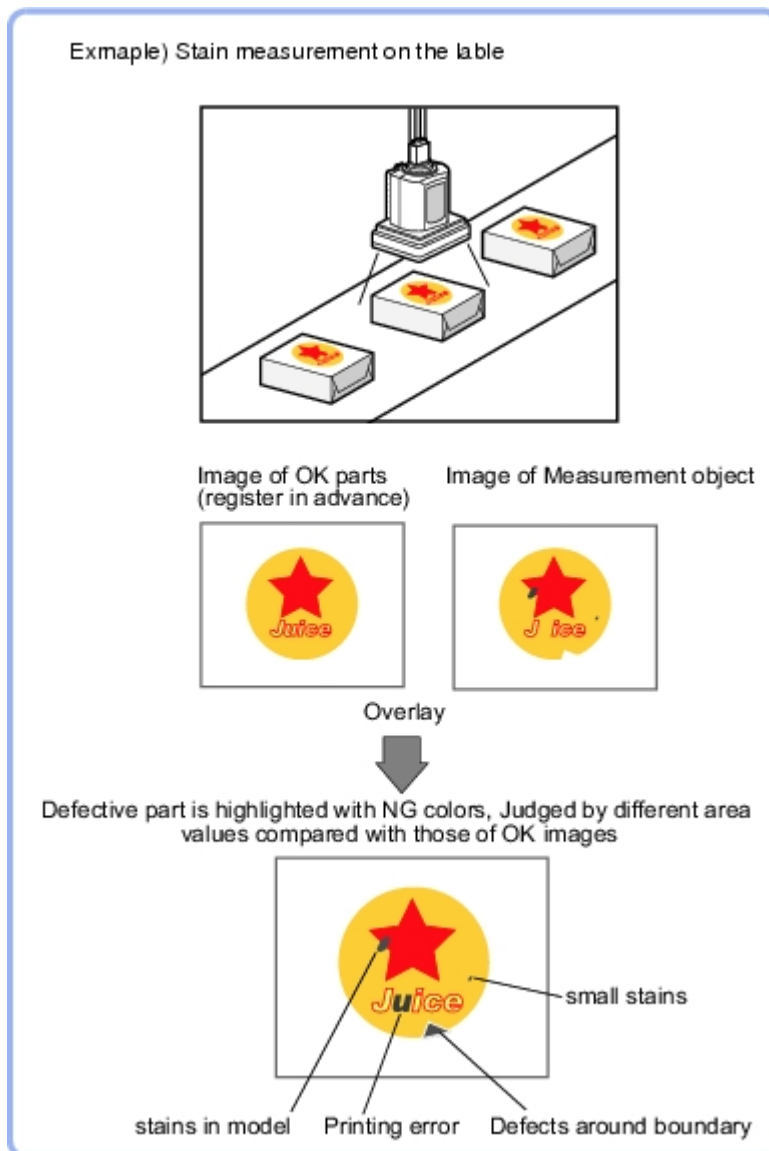

Settings Flow (Fine Matching)

Set up fine matching in the follow steps.

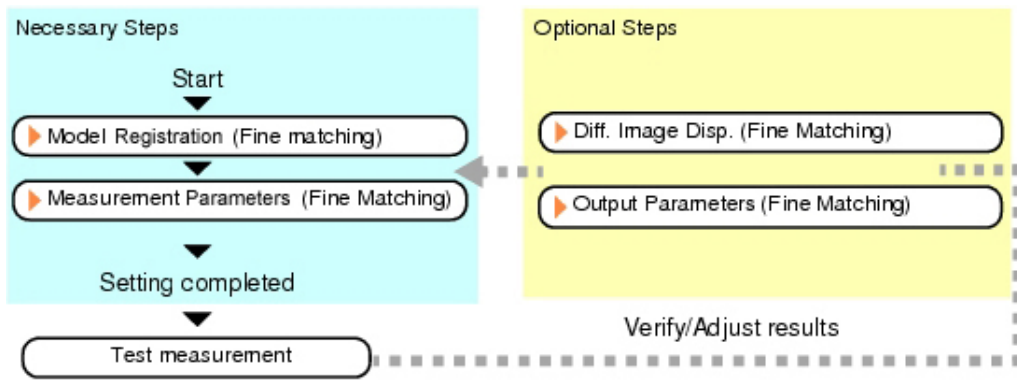

List of Fine Matching Items

Item name	Description
Model register	This item registers the pattern characteristic of the measurement image as a model. Model parameter values can be changed as needed to address unstable measurement results or to increase the processing speed. Normally, the factory default value will be used. Reference: ▶ Model Registration (Fine Matching) (p.235)
Diff. image disp.	Modify this setting as necessary when defects cannot be detected successfully. This sets the reference grayscale used when calculating differences between the model and the inspected object image. Normally, the factory default value will be used. Reference: ▶ Difference Image Display (Fine Matching) (p.236)
Measurement	This item specifies the judgement condition for measurement results. Specify the criteria to judge the measurement result if the X and Y coordinates and the correlation with the model are OK. Measurement parameters can be changed as needed to address unstable measurement results or to increase the processing speed. Reference: ▶ Measurement Parameters (Fine Matching) (p.238)
Output parameter	This item can be changed if necessary. Normally, the factory default value will be used. Use the output parameter to specify how to handle the coordinates. Reference: ▶ Output Parameters (Fine Matching) (p.241)

Note

- Specify [Boundary inspection] in [Model register] and [Inspection] in [Measurement] according to the inspection objectives.

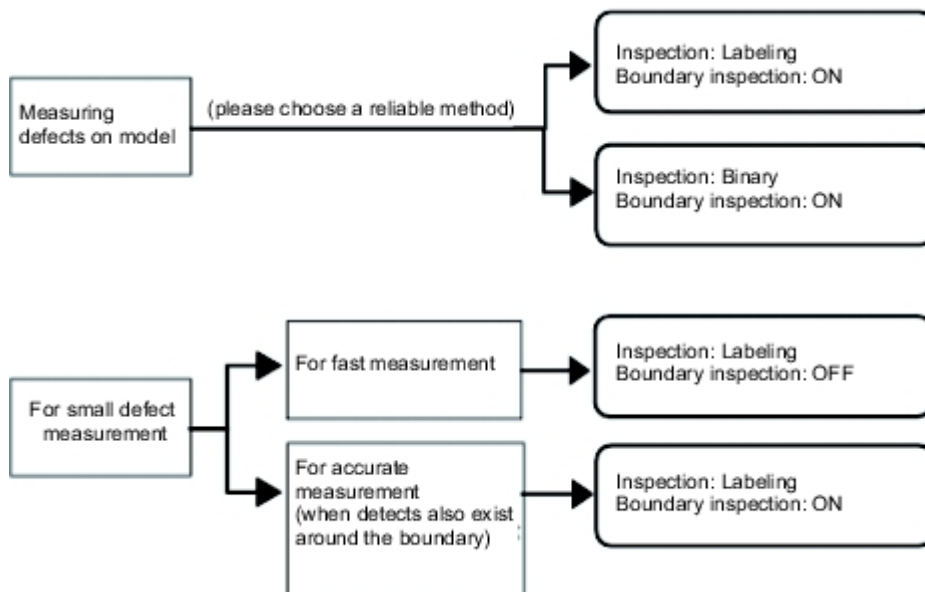

Model Registration (Fine Matching)

Register a fine image as the model. By matching this model with input images, unmatched parts will be detected as defects during inspection.

Note

Ranges that can be registered as models

- The two pixels on the edge of the screen are not registered as a model.
- The registering range will be lower if the images of measurement object are set with Filtering. When you set the image reading range using a camera with the partial scanning function, the range is also limited. Reference: ▶ Filtering (p.304)
- When figures are drawn overlapping, the settings for objects set up afterward are enabled. Reference: ▶ See "User's Manual", "Setting Figures" (p.349)

- In the Item Tab area, tap [Model register].
When setting a new model, you do not have to tap [Model register].
- Use the drawing tools to specify the model registration range.

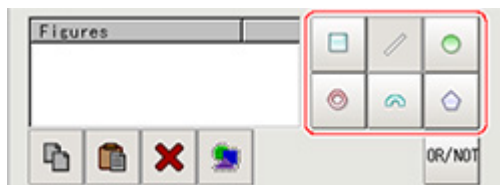

- In the figure setting area, tap [OK].
The model is registered.

Changing Model Parameters

The range can be changed as needed to address unstable measurement results. Normally, the factory default value will be used.

After changing a setting, check whether measurement can be done properly by performing an actual

measurement.

1. In the "Model parameter" area, specify a value for each item.

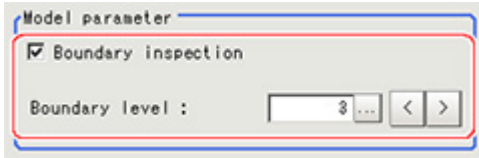

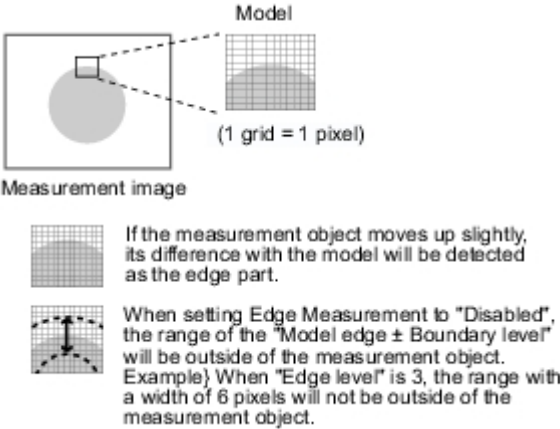
Setting item	Set value [Factory default]	Description
Boundary inspection	[Checked]	Defects around boundaries with color changes can also be detected. The edges similar to those in the model image are not regarded as defects. Check this option when inspecting defects around boundaries, such as chips and burrs. Defects along a direction different from the model image profile are detected in the range of pixels of profile \pm boundary level.
	Unchecked	Boundary areas are excluded from the inspection. This can prevent matching mistakes due to positional deviation of measurement objects, but defects around boundaries cannot be detected. "Boundary level" can be used to specify how many pixels around boundaries should be excluded from the inspection. 
Boundary level	0 to 8 [3]	Select the degree of assimilation of variations around boundaries. Depending on the "Boundary inspection" value, the meaning is different.

Difference Image Display (Fine Matching)





This sets the reference grayscale used when calculating differences between the model and the inspected object image. Modify this setting as necessary when defects cannot be detected successfully. Normally, the factory default value will be used.

After changing a setting, check whether measurement can be done properly by performing an actual measurement.

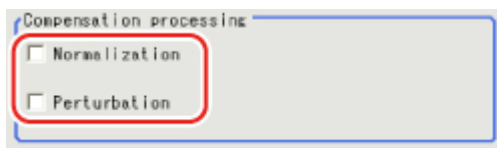
1. In the Item Tab area, tap [Diff. image disp.].

2. In the "Compensation processing" area, select a value for each item.



Setting item	Set value [Factory default]	Description
Normalization	<ul style="list-style-type: none"> • Checked • [Unchecked] 	<p>Specify whether to perform normalization based on the brightness in the registered model.</p> <p>When Normalization is checked, the density is adjusted before matching, so that the matching is not affected by changes in the total image brightness or the lighting fluctuations.</p> <p>When normalization is performed on the measured objects without patterns, the total image brightness is changed and the measurement does not work correctly.</p> <div style="text-align: center;"> <p>Model image</p>  <p>Measurement image (When the whole image turns dark)</p>  <p>Normalization processing</p>   </div>
Perturbation	<ul style="list-style-type: none"> • Checked • [Unchecked] 	<p>If you place a check here, in order to prevent mistaken detection of slight positional deviation of measurement objects as differences, slight positional deviations are corrected before matching. However, this requires more processing time.</p>

3. Input the "Difference" in the "Difference parameter" area.

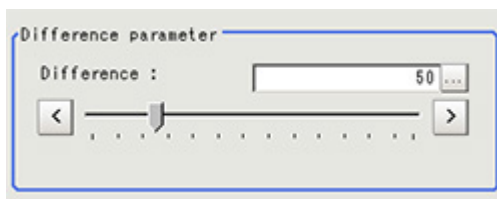

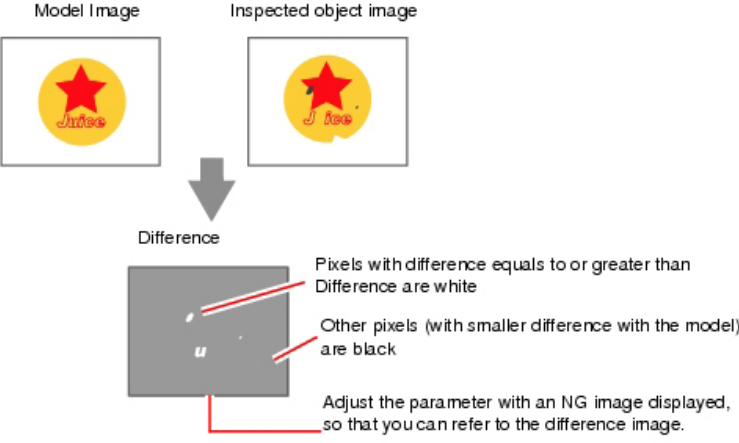
Item	Set value [Factory default]	Description
Difference	0 to 255 [50]	<p>This sets the reference grayscale used when calculating differences between the model and the inspected object image. Pixels with a difference equal to or greater than Difference are converted to white and other pixels are converted to black, so that only defects are converted to white and measured.</p> <div style="text-align: center;">  </div>

Measurement Parameters (Fine Matching)

This item specifies the judgement conditions for measurement conditions and measurement results.

1. In the Item Tab area, tap [Measurement].
2. Select "Inspection" in the "Measurement condition" area.

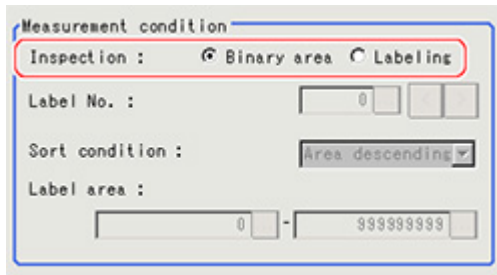

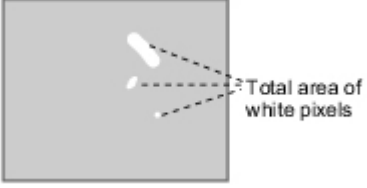
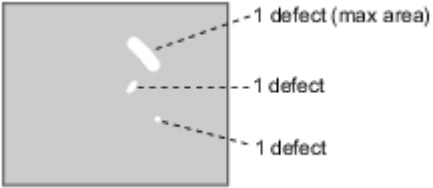
Setting item	Set value [Factory default]	Description
Inspection		Images that are different from the model will be converted into binary images internally. "Inspection" that is used to detect binary images should be selected.
	[Binary area]	Defect is judged based on the total area of white pixels. 
	Labeling	A white pixel will be detected as 1 label, which is then compared with a label which is consistent with the set conditions to determine whether or not it is a defect. 

If "Binary area" is selected, the following operations are not necessary.

When Labeling is selected, the following items are set.

Item	Set value [Factory default]	Description
Label No.	0 to 2499 [0]	Specify the label number used to determine whether defects exist. Different settings for "Sort condition" will lead to different number assignment.

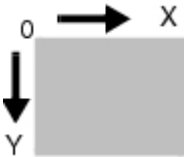
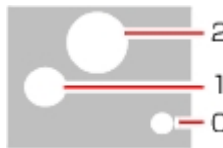
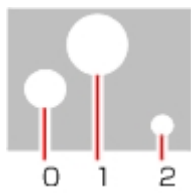
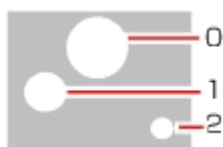
	<p>Specify the conditions by which label number is re-assigned. When sorting referencing the X and Y coordinates, the upper left is the origin. This will not affect the coordinate systems set up through the [Camera Image Input] calibration.</p> 	
Sort condition	Area ascending	<p>Number re-assigning begins from the labels with smaller areas.</p> 
	[Area descending]	<p>Number re-assigning begins from labels with larger area.</p>
	X ascending	<p>Number re-assigning begins from the label with a smaller gravity X coordinate.</p> 
	X descending	<p>Number re-assigning begins from the label with a larger gravity X coordinate.</p>
	Y ascending	<p>Number re-assigning begins from the label with a smaller gravity Y coordinate.</p> 
	Y descending	<p>Number re-assigning begins from the label with a larger gravity Y coordinate.</p>
Label area	[0] to [999999999]	Specify the range of the area to be judged as a label.

- When the setting has been changed, tap [Measurement] in the Detail area to verify whether measurements can be made correctly.



4. Set up the judgement condition.

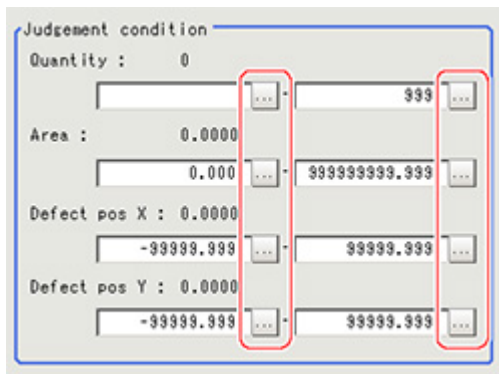

Setting item	Set value	Description
Quantity	0 to 9999	Specify the range of the number of labels that is judged to be OK.. When "Binary area" is used, the white pixels as a whole will be regarded as one label.
Area	0 to 99999999.9999	Specify the range of the area that is judged to be OK.. When the "Labeling" is used, the area of the label number will be specified instead.
Defect pos X	-99999.9999 to 99999.9999	Specify the X and Y axis move ranges for the center of gravity positions that are judged to be OK. When the "Labeling" is used, the center of gravity position of the label number will be specified instead.
Defect pos Y	-99999.9999 to 99999.9999	Specify the X and Y axis move ranges for the center of gravity positions that are judged to be OK. When the "Labeling" is used, the center of gravity position of the label number will be specified instead.

Note

- Defect coordinates give the center of gravity position of detected defects.

Output Parameters (Fine Matching)

Specify how to treat the coordinates to be output to the external device as measurement results. This item can be changed if necessary. Normally, the factory default value will be used.

Important

- After setting up the measurement parameters, changing the output parameters will cause measurement results to vary accordingly. If the output parameters have been changed, re-specify the measurement, too.

1. Tap [Output parameter] in the Item Tab area.

2. Specify each of the following items.

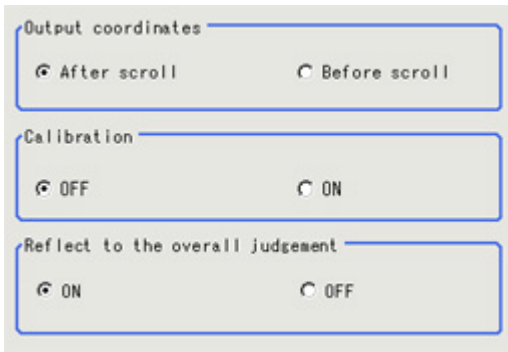

Setting item	Set value [Factory default]	Description
Output Coordinates	<ul style="list-style-type: none"> · [After scroll] · Before scroll 	As measurement results, select whether to output coordinate values to external devices before or after the position deflection correction is applied.
Calibration	<ul style="list-style-type: none"> · [OFF] · ON 	Select whether to reflect the calibration in the values output to the external device as measurement results. ON: Output the coordinates converted into actual dimensions. OFF: Output the camera coordinate values.
Reflect to overall judgement	<ul style="list-style-type: none"> · [ON] · OFF 	Enables choosing whether or not the judgement result of this processing unit is reflected in the scene overall judgement.

Key Points for Test Measurement and Adjustment (Fine Matching)

The following content is displayed in the "Detail result" area as text.

Displayed items	Description
Judge	Judgement result
Count	Number of defects
Area	Defect area
Defect coordinate X	Defect coordinate X
Defect coordinate Y	Defect coordinate Y

Key Points for Adjustment

Select the adjustment method referring to the following points.

When the measurement results are unstable

When non-existent defects are detected around the boundary

Parameter to be adjusted	Remedy
Model	Uncheck" Boundary inspection".

Measurement	Set "Labeling" as the "Inspection".
-------------	-------------------------------------

When noise is detected as defects/defects cannot be detected

Parameter to be adjusted	Remedy
Diff. image disp.	Adjust "Difference".

Measurement object near plain area

Parameter to be adjusted	Remedy
Diff. image disp.	Uncheck "Normalization".

When the processing speed is slow

Parameter to be adjusted	Remedy
Model	Uncheck" Boundary inspection".
Measurement	Set "Labeling" as the "Inspection".

Measurement Results for Which Output Is Possible (Fine Matching)

The following values can be output using processing items related to results output. It is also possible to reference measurement values from expressions and other processing units.

Measurement items	Character string	Description
Judgement	JG	Judgement result
Quantity	DA	Number of labeling
Area	AR	Area
Defect position	X	X coordinate of center of gravity position of measured defects
Defect position	Y	Y coordinate of center of gravity position of measured defects

Character Inspection

Using model images registered in a [Model Dictionary], this processing item performs character recognition by correlation searches.

Important

- The model dictionary needs to be created in advance.
Reference: ▶ Model Dictionary (p.261)

Used in the Following Case

- When identifying standard character data (check of product model name)



Settings Flow (Character Inspection)

The setting procedure for character inspection is as follows:

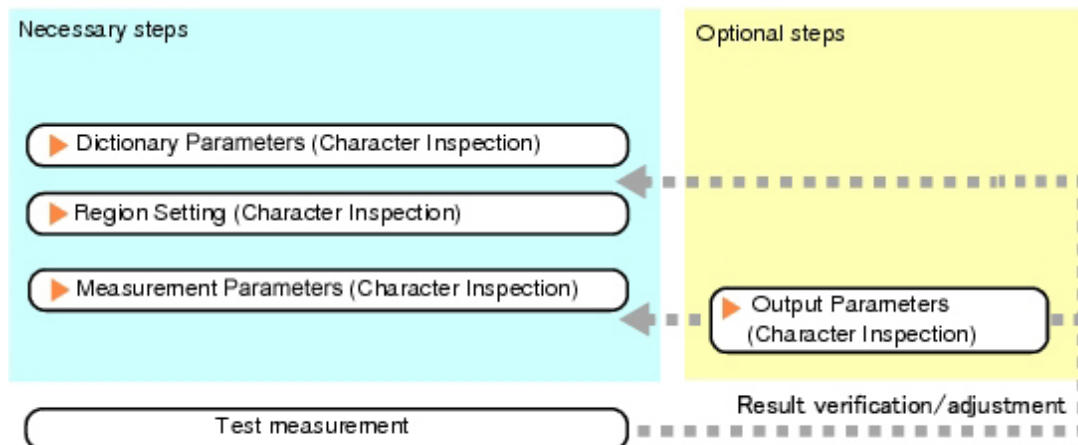

List of Character Inspection Items

Item name	Description
Dictionary	This item specifies the processing unit number for the model dictionary to use for character recognition. Reference: ▶ Dictionary Parameters (Character Inspection) (p.245)
Region setting	This item is used to set up the measurement area. Instead of measuring the entire input image, narrowing the measurement area shortens the processing time. Reference: ▶ Region Setting (Character Inspection) (p.246)
Measurement	This item specifies the judgement condition for measurement results. Specify the criteria to judge the measurement result if the X and Y coordinates and the correlation with the model are OK. Reference: ▶ Measurement Parameters (Character Inspection) (p.246)
Output parameter	This item can be changed if necessary. Normally, the factory default value will be used. Use the output parameter to specify how to handle the coordinates. Reference: ▶ Output Parameters (Character Inspection) (p.248)

Dictionary Parameters (Character Inspection)

This item selects the processing unit number for the model dictionary to use for character inspection.

1. In the Item Tab area, tap [Dictionary].
2. In the "Dictionary unit" area, select the unit number.

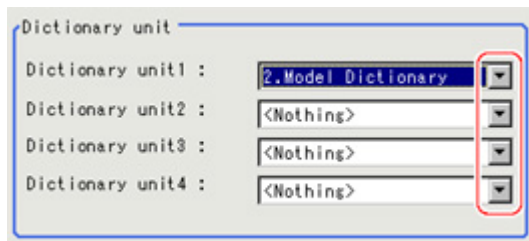

3. If necessary, specify an index to use.
 1. Tap [▼] and select the dictionary unit to be specified.
The following character strings are registered.

- Place a check at the character(s) to use for character inspection.



- Tap [OK].
The model dictionary to use is set.

Region Setting (Character Inspection)

This item is used to set up the measurement area.

Instead of measuring the entire input image, narrowing the measurement area shortens the processing time.

This item specifies the measurement region of [Character Inspection] using a rectangle.

- In the Item Tab area, tap [Region setting].
- Tap [Edit].

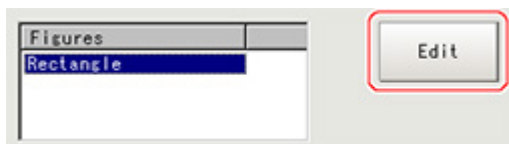

The figure setting area is displayed.

- Specify the area in which to search for the model.
The rectangle covering the entire screen is set. Adjust the size and position of the rectangle.
- Tap [OK].
The area to measure is registered.

Note

Number of characters that can be inspected

- Up to 32 characters can be inspected in the measurement region.

Measurement Parameters (Character Inspection)

Set the character inspection contents, the trimming method and the judgement conditions for the measurement results.

1. In the Item Tab area, tap [Measurement].
2. In the "Inspection condition" area, specify a value for each item.

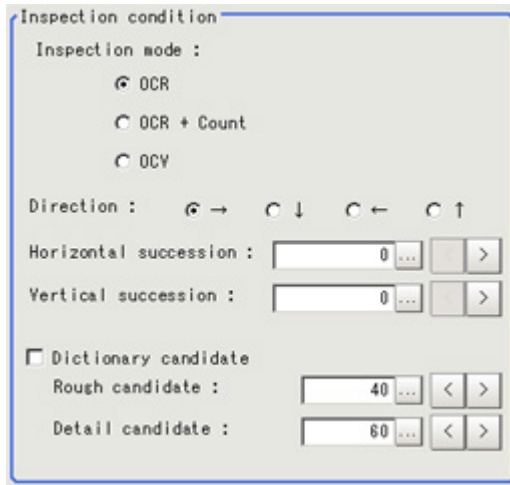

Setting item	Set value [Factory default]	Description	
Inspection mode	<ul style="list-style-type: none"> • [OCR] • OCR + Count • OCV 	Select the inspection mode of characters. <ul style="list-style-type: none"> • OCR: The character string is read in. • OCR + Count: The character string is read in. Also, the number of characters is inspected. • OCV: Inspects whether or not the same characters are lined up as the preset correct character string combination. 	
Direction	[→] ↓ ← ↑	Specify the direction of character reading.	
Horizontal succession	[0] to 99	If the characters are too close together to read in well, increase this. Specify the allowable overlapping range to be read for candidate points. This item is enabled when "Direction" is " → " or " ← ".	
Vertical succession	[0] to 99	Specify the allowable overlapping range to be read for candidate points. This item is enabled when "Direction" is " ↓ " or " ↑ ".	
Dictionary candidate	<ul style="list-style-type: none"> • [Unchecked] (Not used) • Checked (Used) 	Specify whether to use candidate point levels specified in the Model Dictionary or not.	
	Rough candidate	0 to 100 [40]	When "Dictionary candidate" is unchecked, specify a value for the Rough candidate.
	Detail candidate	0 to 100 [60]	When "Dictionary candidate" is unchecked, specify a value for the Detailed candidate.

3. Set up the judgement condition.

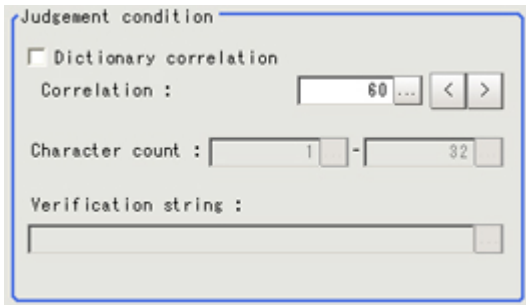

Setting item	Set value [Factory default]	Description
Dictionary correlation	<ul style="list-style-type: none"> • [Unchecked] (Not used) • Checked (Used) 	Specify whether to use the correlation lower limit set in the Model Dictionary or not.
Correlation	0 to 100 [60]	When "Dictionary correlation" is unchecked, specify the Correlation.
Character count	1 to 32	When "Inspection mode" is "OCR + Count", specify the judgement condition for the number of characters.
Verification string	A string with up to 32 characters. [(None)]	When "Inspection mode" is "OCV", specify the Verification string. "*" in the Verification string is a wild card. Verification of whether a character is "*" is not possible. For sections to be judged OK no matter what characters are present and to just inspect whether or not there are characters at all, use "*".

Output Parameters (Character Inspection)

Select how measurement results are output to an external device. This item can be changed if necessary. Normally, the factory default value will be used.

1. Tap [Output parameter] in the Item Tab area.
2. Specify a value for each item.

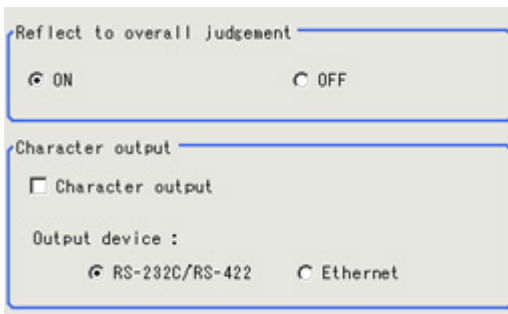

Setting item		Set value [Factory default]	Description
Reflect to overall judgement		<ul style="list-style-type: none"> • [ON] • OFF 	Select whether have the judgement result of this processing unit reflected in the overall judgement of the scene.
Character output	Character output	<ul style="list-style-type: none"> • [Unchecked] • Checked 	Specify whether to output read-in character strings to an external device.
	Output device	<ul style="list-style-type: none"> • [RS-232C/ RS-422] • Ethernet 	When "Character output" is checked (output), this specifies the device to which strings are output.Character strings are output as ASCII code character strings. When kanji or other characters that are not ASCII codes are included, they are not output correctly.

Note

- For character output, if there was no read character string, then the delimiter is output.

Key Points for Test Measurement and Adjustment (Character Inspection)

The following content is displayed in the "Detail result" area as text.

Displayed items	Color of display	Description
Judge	OK/Unmeasured: Black NG: Red	Judgement result
NG Cause	0: Black Other than 0: Red	The following character strings are displayed. When there are multiple factors, the output is ORed. If both the correlation value and the character count are NG, "3" is output. 0: OK 1: Correlation values NG 2: Character count NG 4: Verification NG
Chara count	When the NG cause is the character count NG: Red Other NG: Black	The number of measured characters is displayed.
Read string	When the NG cause is verification NG: Red Other NG: Black	A character string read from the target unit is displayed.
Correlation	When the NG cause for each character is the correlation value NG: Red Other NG: Black	The correlation values for each character are displayed. Example) When 0123 is read Correlation values: 0(99) 1(56) 2(80) 3(27)

Key Points for Adjustment

Select the adjustment method referring to the following points.

When the measurement results are unstable

When the reading is unstable

Parameter to be adjusted	Remedy
Measurement	If characters are close, specify larger values for "Horizontal succession", "Vertical succession".

The judgement is NG (insufficient memory).

Parameter to be adjusted	Remedy
Region setting	Specify as small a value as possible for FigureInfo=Region.

When the processing speed is slow

Parameter to be adjusted	Remedy
Region setting	Specify as small a value as possible for FigureInfo=Region.

Measurement Results for Which Output Is Possible (Character Inspection)

The following values can be output using processing items related to results output. It is also possible to reference measurement values from expressions and other processing units.

Measurement items	Character string	Description
Judgement	JG	Judgement result
Number of Characters	NUM	Chara. Num
NG cause	NG	NG cause
For following items, additional expression data with 32 characters is allocated for each character. (* represents the character number.)		
Unit No.*	CUNO*	Detected unit No. for the *th character
Index No.*	CINDEX*	Detected index number for the *th character
Model No.*	CMODEL*	Detected model number for the *th character
Character code*	CCHAR*	Character code for the *th character Reference: ▶ "User's Manual", "Character Code Table" (p.364)
NG Cause *	CNG*	NG cause for the *th character

About Output at PLC Link

1. About output of character inspection

If PLC link communication is performed, selecting the "Character output" check box among the output parameters for character inspection will cause character string data to be output to the PLC link output area. (FZ3 Ver. 2.10 or later)

If 32 characters are read (read character string: 0123456789...UV), a continuous ASCII code data string is output as shown below.

Output area

Top channel	Name	Output contents
+0ch	1st character, 2nd character	3031 (ASCII code corresponding to character "0," ASCII code corresponding to character "1")
+1ch	3rd character, 4th character	3233 (ASCII code corresponding to character "2," ASCII code corresponding to character "3")
.		
.		
.		
+15ch	31st character, 32nd character	5556 (ASCII code corresponding to character "U," ASCII code corresponding to character "V")

2. How to receive character string data

As you do when serial data is output via PLC link, control the DSA data output request bit and GATE data completion request bit.

Since the entire character string comprises 1 data, DSA control is performed once if there is only 1 character inspection unit.

Date Verification

This processing item creates a target string from the current date/time and compares it with read-in strings.

Used in the Following Case

- When inspecting date of manufacture

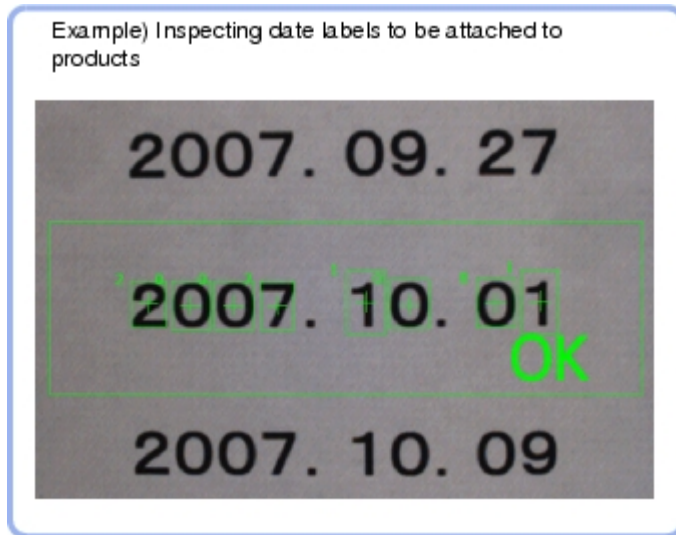

Settings Flow (Date Verification)

Follow the steps below to set up [Date Verification].

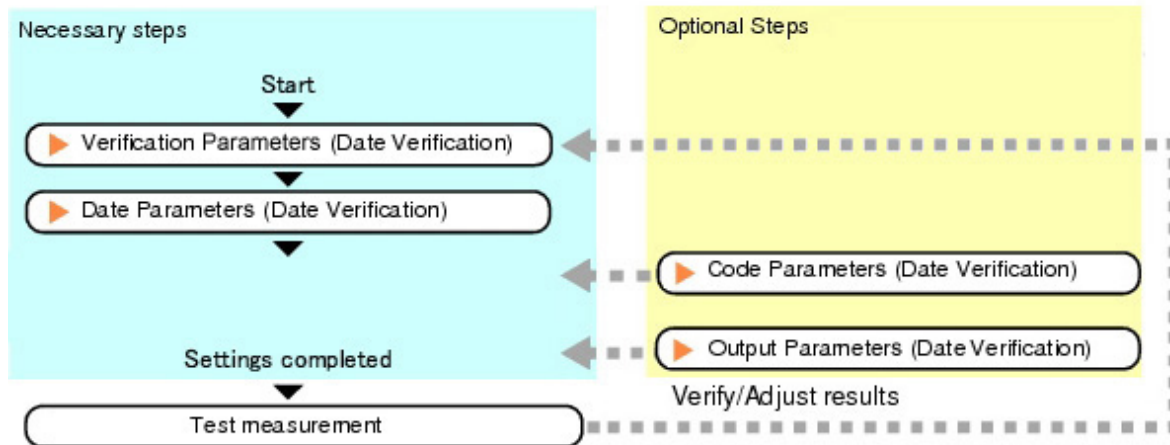

List of Date Verification Items

Item name	Description
Verification	This item sets parameters of the verification string. Reference: ▶ Verification Parameters (Date Verification) (p.253)
Date parameter	This item sets the date/time format and update conditions. Reference: ▶ Date Parameters (Date Verification) (p.255)

Code parameter	Set this to print the date encrypted in such a way that it is difficult for the user to recognize. Setting what codes show also makes possible automatic updating. Reference: ▶ Code Parameters (Date Verification) (p.256)
Output parameter	This item can be changed if necessary. Normally, the factory default value will be used. Use the output parameter to specify how to handle the coordinates. Reference: ▶ Output Parameters (Date Verification) (p.259)

Verification Parameters (Date Verification)

This item sets the verification target and the verification source character string.
The character string read in Character Inspection is the target for verification.

1. In the Item Tab area, tap [Verification].
2. This item sets the general OCR unit for verification.

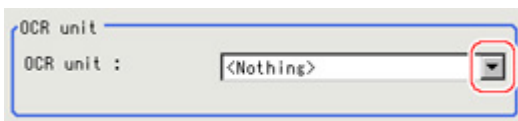

Note

- Always set Character Inspection in a unit before the Date Verification unit.

3. In the "Target string setting" area, tap [...] for "Target string expression".

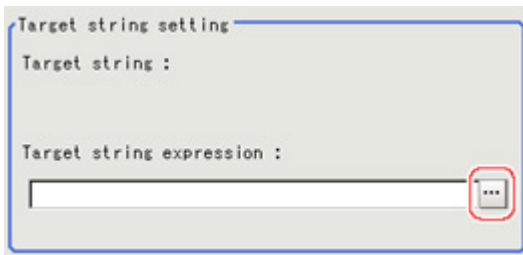

The String setting dialog is displayed.

4. This item sets the character string that is the source for verification.
Input the date format and the preceding and following character strings.

Target string expression

0 1 2 3 4 5 6 7 8 9 BS DEL CLR

A B C D E F G H I J ← →

K L M N O P Q R S T

U V W X Y Z ' - . : / * \$

mYY mYYYY mHH mMM mDD mRR mNN

vYY vYYYY vHH vMM vDD

eY1 eM1 eD1 eR1 eN1

eY2 eM2 eD2 eR2 eN2

OK Cancel

Label	Description
0 to 9	Normal numeric value input
A to Z	Normal alphabet input
' - . : /	Normal mark input
*	Character presence judgement
\$	Number judgement
mYY	The last two digits of the current year
mYYYY	Four digits of the current year
mHH	Two digits of the current year in the Japanese Heisei calendar
mMM	Current month
mDD	Current day
mRR	Current hour
mNN	Current minute
vYY	The last two digits of the year after a set period of time
vYYYY	Four digits of the year after a set period of time
vHH	Two digits of the year after a set period of time in the Japanese Heisei calendar
vMM	Month after a set period of time
vDD	Day after a set period of time
eY1	Encrypted year 1
eM1	Encrypted month 1
eD1	Encrypted day 1
eR1	Encrypted hour 1
eN1	Encrypted minute 1
eY2	Encrypted year 2
eM2	Encrypted month 2
eD2	Encrypted day 2
eR2	Encrypted hour 2
eN2	Encrypted minute 2

5. Tap [OK].

Date Parameters (Date Verification)

This item sets the date/time format and update conditions.

1. In the item tab area, tap [Date parameter].
2. When comparing with character strings with an expiration date limit, set each item in the "Period setting" area.

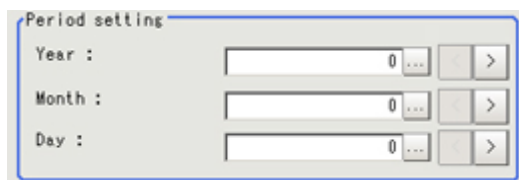

Setting item	Setting value [Factory default]	Description
Year	0 to 99 [0]	This item sets the usage period from the current date. Example) When the current date is Oct. 1, 2007 and the usage period is 10 days, the expiration date is Oct. 11, 2007.
Month	0 to 99 [0]	
Day	0 to 999 [0]	

3. In the "Date setting" area, specify a value for each item.

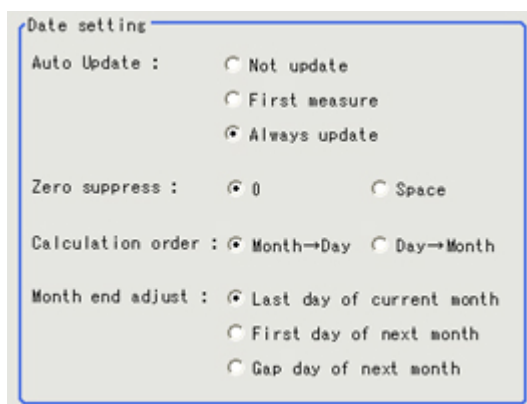

Setting item	Setting value [Factory default]	Description
Auto Update	<ul style="list-style-type: none"> • Not update • First measure • [Always update] 	Set the year, month and day updating conditions. The clock time is always updated. <ul style="list-style-type: none"> • Not update: The date is stored into memory when the processing unit is registered. The date is not updated until the next time date update is executed with the menu. • First measure: The date is updated during the first measurement after start up. • Always update: The date is updated every measurement.
Zero suppress	<ul style="list-style-type: none"> • [0] • Space 	Set how the tens digits of the month and day are displayed.

Calculation order	<ul style="list-style-type: none"> • [Month → Day] • Day → Month 	Set whether to calculate the month first or the day first when the usage period is set. (This affects calculation of end of month.)
Month end adjust	<ul style="list-style-type: none"> • [Last day of current month] • First day of next month • Gap day of next month 	Set the adjustment method that will be used if the result of the expiration date calculation is an invalid date. Example) When the current date is Jan. 31 and the usage period is 1 month "Last day of current month" = Feb. 28 "First day of next month" = Mar. 1 "Gap day of next month" = Mar. 3

4. Set the time margin.

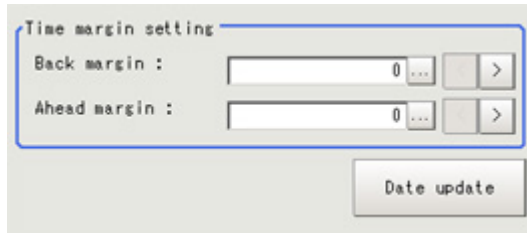

Setting item	Setting value [Factory default]	Description
Back margin	0 to 99 [0]	Set the time before the current time to be judged OK The unit is minutes. Example) If 10 is set, an OK judgement is rendered up to the character string 10 minutes before the verification string.
Ahead margin	0 to 99 [0]	Set the time after the current time to be judged OK The unit is minutes. Example) If 10 is set, an OK judgement is rendered up to the character string 10 minutes after the verification string.

Tapping [Date update] updates the date information of the verification string.

Code Parameters (Date Verification)

Preset what the codes show so that date verification is possible even when printing the date encrypted in such a way that it is difficult for the user to recognize.

The setting methods are to set on the screen or set with a PC.

Important

- If a usage period is set, encrypted characters cannot be used for character verification.

Setting on the Screen

This describes the setting method, using an example in which October is encrypted as X.

1. In the item tab area, tap [Code parameter].

- Place a check at "Code month 1 flag".

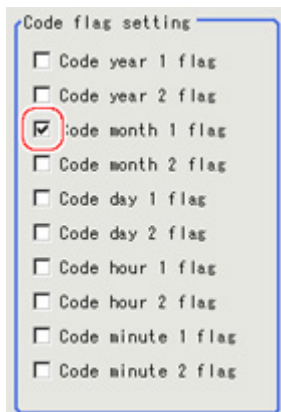

Note

Code month 1 and code month 2

- Set up code files for 2 patterns in order to be ready for setup changes. Select a checkbox at the one to use.

- Place a check at "Code month 1" in the "Code detail setting" area.

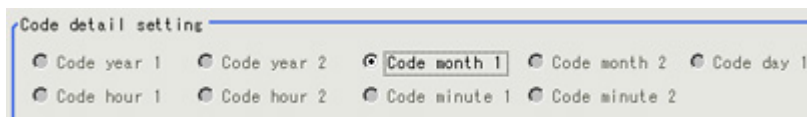

- Tap [...] for "10".
The software keyboard is displayed. Input "X".

Input a character string of up to 4 characters.



Setting with a PC

Code files are complex, so performing the settings with a PC makes file editing easier and minimizes mistakes.

Saving an empty CSV file first and then editing and reading it with a PC makes setting the values more efficient.

Saving code files

Make an empty file for editing on the PC.

If encryption parameters are already set on the screen, a file reflecting those settings is saved.

1. In the item tab area, tap [Code parameter].
2. Place a check at the flag used in the encrypted character strings to be edited.

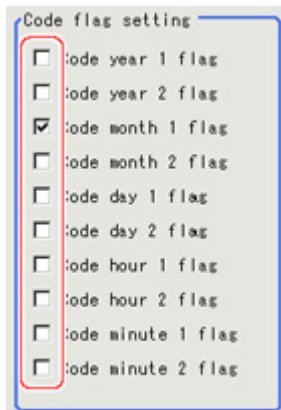

3. In the "Code file" area, tap [Save code file].

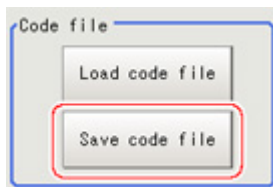

4. Set the save destination folder and file name, and tap [OK].
The code file is saved (in CSV format).

Code file format

- The first line shows the "Code".
- The second line shows the "Flag". Input "1" when used.
- The third line and subsequent lines contain codes for each number.

Months and days start from "1".

Code	Year1	Year2	Month1	Month2	Day1	Day2	Hour1	Hour2	Minute1	Minute2
Flag										
0										
1										
2										
3										
4										
5										
6										
7										
8										
9										
10										
11										
12										
13										
14										
15										
16										
17										
18										
19										
20										
21										
22										
23										
24										
25										
26										
27										
28										
29										
30										
31										
32										
.										
.										
.										
98										
99										

Reading code files

1. In the item tab area, tap [Code parameter].
2. In the "Code file" area, tap [Load code file].

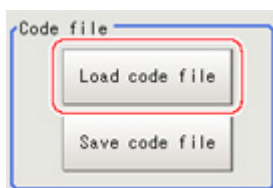

3. In the file selection window, select the code file (in CSV format) to read and tap [OK].
The code file is read and the content is displayed in the window.

Output Parameters (Date Verification)

Specifies whether or not the judgement results of this processing unit is reflected in the scene overall judgement.

1. Tap [Output parameter] in the Item Tab area.
2. Choose whether or not to reflect this in the scene overall judgement in "Reflect to overall"

judgement" area.



Setting item	Set value [Factory default]	Description
Reflect to overall judgement	<ul style="list-style-type: none"> • [ON] • OFF 	Enables choosing whether or not the judgement results of this processing unit is reflected in the scene overall judgement.

Test Measurement (Date Verification)

The following content is displayed in the "Detail result" area as text.

Displayed items	Description
Judge	Judgement result
Target string	Target string setting is displayed.
Read string	A character string read from the OCR unit is displayed.

Measurement Results for Which Output Is Possible (Date Verification)

The following values can be output using processing items related to results output. It is also possible to reference measurement values from expressions and other processing units.

Measurement items	Character string	Description
Judgement	JG	Judgement result

Model Dictionary

Register a model to use for [Character Inspection].
 Model data registered in the [Model Dictionary] can be referred to from multiple [Character Inspection] items in the same scene.

Used in the Following Case

- To create the dictionary to be used for Character Inspection and Date Verification

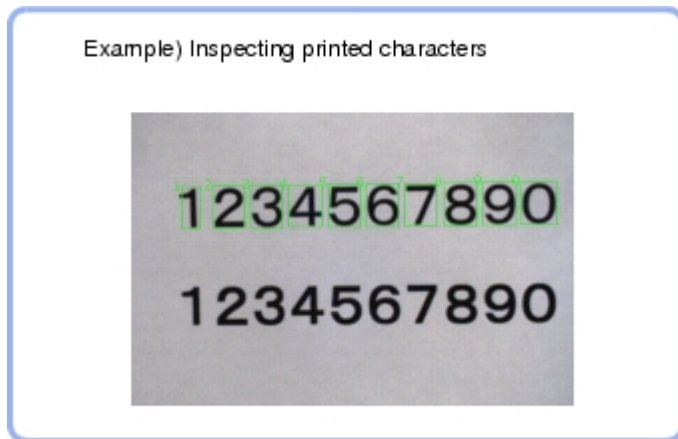

Settings Flow (Model Dictionary)

Follow the steps below to set up [Model Dictionary].

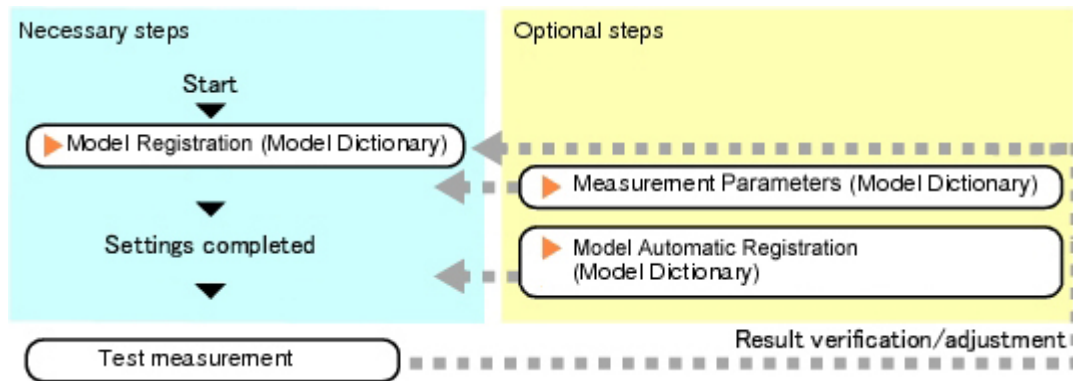

List of Model Dictionary Items

Model Dictionary items are explained below.

Item name	Description
Model register	Register the characters and marks as the model. Model parameter values can be changed as needed to address unstable measurement results or to increase the processing speed. Normally, the factory default value will be used. Reference: ▶ Model Registration (Model Dictionary) (p.262)
Measurement	This item can be changed if necessary. Reference: ▶ Measurement Parameters (Model Dictionary) (p.265)
Auto registration	When registering multiple characters as models, auto registration is handy. This method encloses a character string, cuts out one character at a time from it and registers them as models. Reference: ▶ Model Automatic Registration (Model Dictionary) (p.266)

Model Registration (Model Dictionary)

Register the characters and marks as the model.

Models can be registered with any of 36 indexes, from 0 to 35, and up to 5 models can be registered for each index.

Select the Character Type

By factory default, 0 to 9 and A to Z are assigned to indexes 0 to 35. These assignments can be changed as necessary with the "%" and "#" codes.

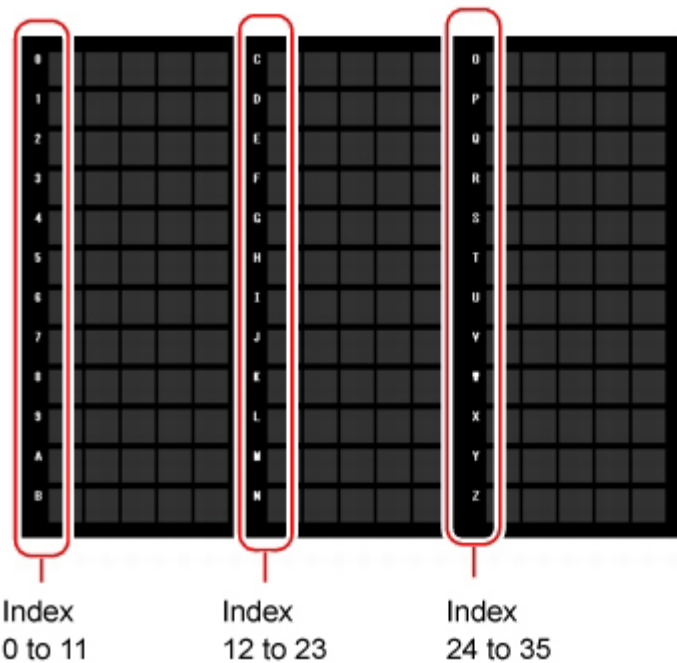

1. In the Item Tab area, tap [Model register].
When setting a new model, you do not have to tap [Model].
2. Set the character type.

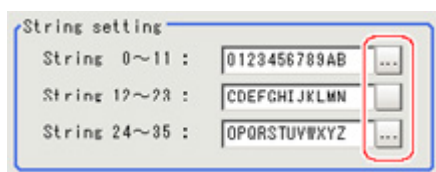

Registering a Model

This method is for registering models one character at a time.

Note

- When registering multiple characters as models, auto registration is handy.
Reference: ▶ Model Automatic Registration (Model Dictionary) (p.266)

1. In the Item Tab area, tap [Model register].
2. When the measurement object is rotating, set the Angle range for the "Model parameter" area.

Reference: ▶ Changing Model Parameters (p.264)

3. Select the index to register the model in, then tap [New].

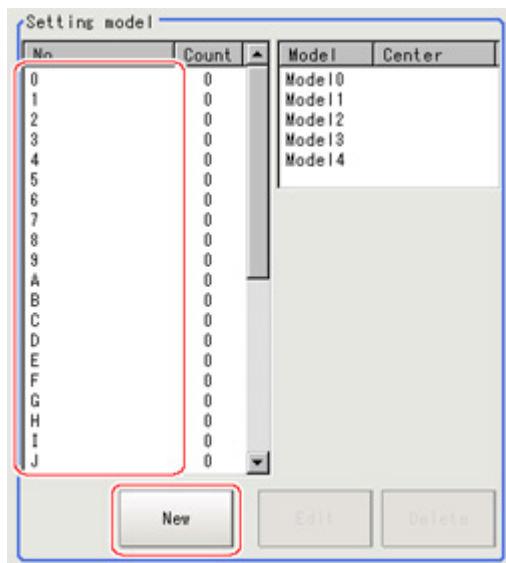

4. Use the drawing tools to specify the model registration range.

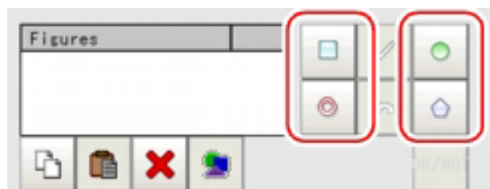

5. Tap [OK].

The model is registered and its central X and Y coordinate values are displayed in the "Setting model" area.

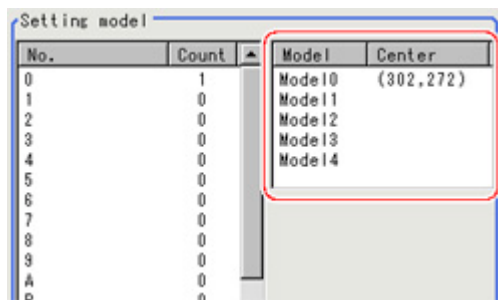

The image specified for the model is displayed in the Image Display area.

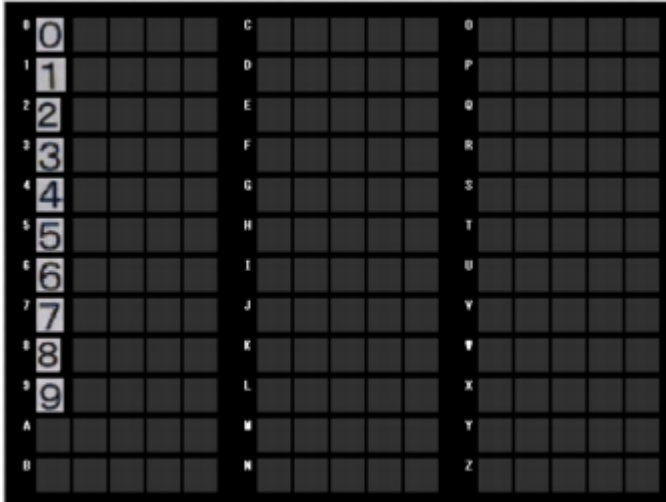

6. To register two or more models, repeat the Steps Reference: ▶ 3(p.263) to Reference: ▶ 5(p.263) .

Changing Model Parameters

Model parameter values can be changed as needed to address unstable measurement results or to increase the processing speed. Normally, the factory default value will be used. After changing a setting, check whether measurement can be done properly by performing an actual measurement.

Important

- After model parameters are modified, re-register all models.

1. In the "Model parameter" area, specify a value for each item.

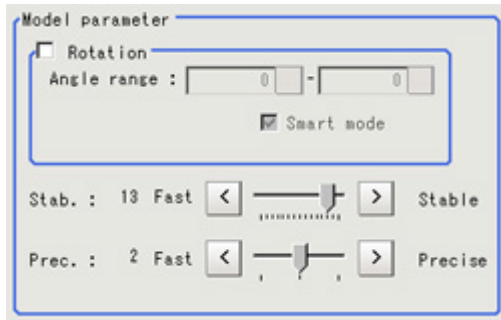

Setting item	Set value [Factory default]	Description
Rotation	<ul style="list-style-type: none"> • Checked • [Unchecked] 	When the measurement object rotates, place a check at "Rotation" and set the Angle range during a search. The normal direction is clockwise.
Angle range	-45 to 45 [0]	
Smart mode	<ul style="list-style-type: none"> • [Checked] • Unchecked 	Checking the "Smart mode" option enables a high-speed rotation search. The stability may be lowered when the model shape aspect ratio is large or when the NOT mask is used.

Stability	1 to 15 [13]	Specify which is to have priority, detection stability or speed. If lowering stability does not speed up processing, it is likely that many candidates have been detected. In this case, specify a larger value for "Candidate level" or "Stab."
Preciseness	1 to 3 [2]	Specify which is to have priority, measurement positional precision or speed.

Measurement Parameters (Model Dictionary)

This item can be changed if necessary. Normally, the factory default value will be used.

1. In the Item Tab area, tap [Measurement].
2. In the "Measurement condition" area, specify a value for each item.

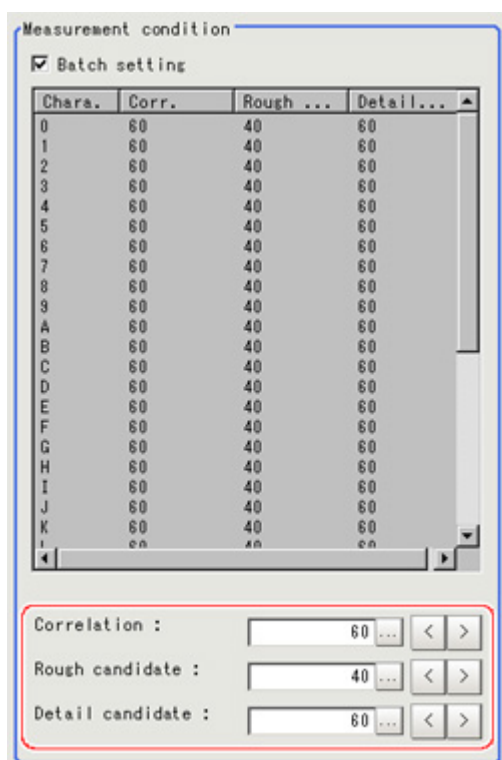

Setting item	Set value [Factory default]	Description
Batch setting	<ul style="list-style-type: none"> · [Checked] · Unchecked 	Specify whether to set all Measurement values at the same time. <ul style="list-style-type: none"> · Checked: The same contents are set for all indexes. · Unchecked: The contents are only set for the selected index.
Correlation	0 to 100 [60]	Specify the lower limit of correlation values that are judged to be OK. This is the threshold for whether or not the candidate can be read in as a character.
Rough candidate	0 to 100 [40]	Specify the threshold value with which to detect candidate points in a rough search. Specify a smaller value when model search results are unstable.

Detail candidate	0 to 100 [60]	Specify the threshold value with which to detect candidate points in a detail search. Only the candidate points higher than this level are extracted as characters.
------------------	------------------	---

Model Automatic Registration (Model Dictionary)

This method encloses a character string, cuts out one character at a time from it and registers them as models. When an auto extraction region is set enclosing the character string, the characters are automatically extracted one at a time. Register each character in the appropriate character index. If 5 models have already been registered for an index, auto registration cannot be set.

1. In the Item Tab area, tap [Auto registration].
2. In the Detail area, select "Auto extract region".



3. Tap [Edit].



4. Specify the range to register as the auto extract region using the drawing tools.

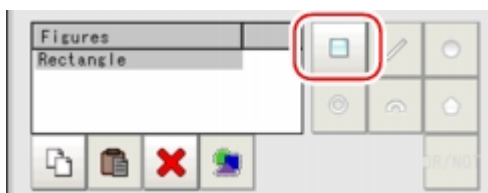

5. In the figure setting area, tap [OK].
The auto extract region is registered.
6. Tap [Extract model].



A model is extracted automatically and the extracted result (gray frame) is displayed in the Image Display area.

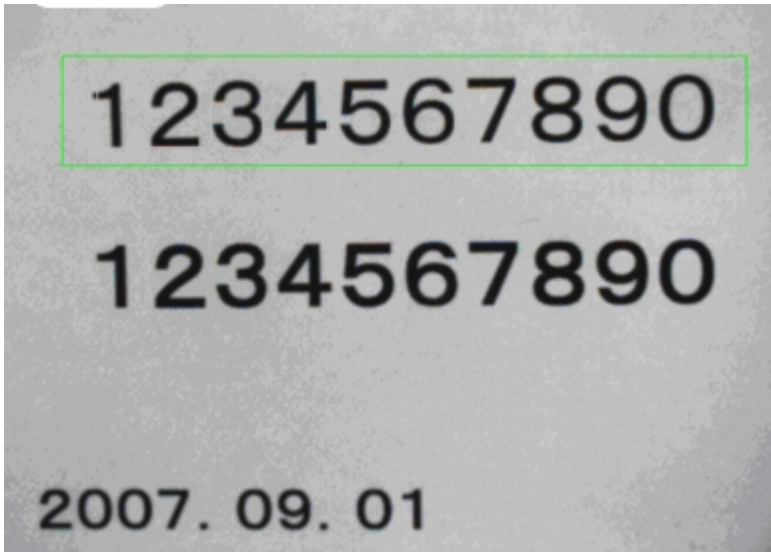

7. In the Detail area, select "Auto model region".

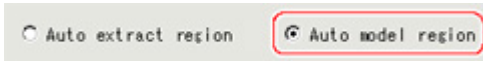

8. To adjust an extracted region, tap [Edit].



9. Tap the model region in the Image Display area.
In the context menu, an index list is displayed.

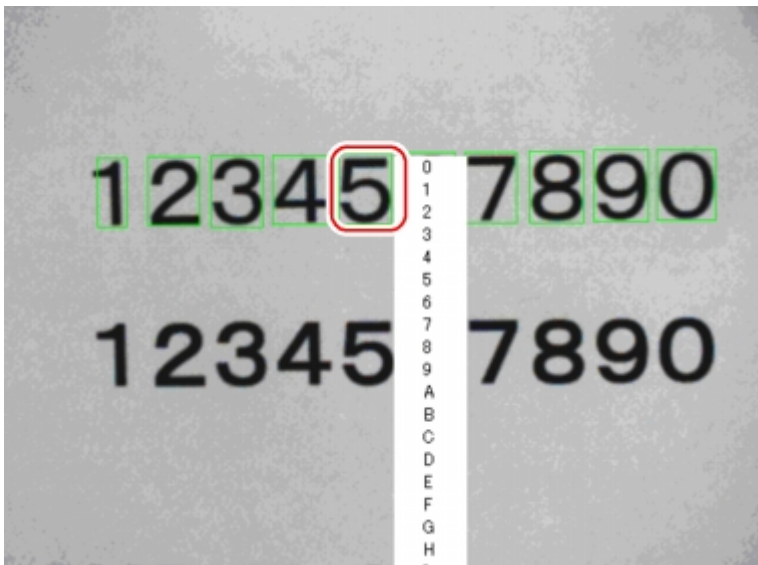

10. Select the index to register to.
11. Tap [Register model].



A message which indicates the number of registered models is displayed.

12. Tap [OK].

The model is registered.

With the same operation, register the models for the other extraction regions.

Key Points for Test Measurement and Adjustment (Model Dictionary)

The following content is displayed in the "Detail result" area as text.

Displayed items	Description
Judge	Judgement result

Key Points for Adjustment

Select the adjustment method referring to the following points.

When the measurement results are unstable

Parameter to be adjusted	Remedy
Model parameter	If the model image consists of detailed figures, specify a larger value for "Stab." When "Rotation" is selected, if the model shape is complex, uncheck the "Smart mode" option.
Measurement	If images that should be judged OK vary greatly, specify a smaller value for "Candidate level".

When the processing speed is slow

Parameter to be adjusted	Remedy
Model parameter	If the model image is a simple figure or a large figure, specify a smaller value for "Stab." If lowering stability does not speed up processing, it is likely that many candidates have been detected. Raise the "Candidate level" in [Measurement]. When "Rotation" is selected, if the model shape is simple, place a check at the "Smart mode" option.
Measurement	If images that should be judged OK vary little, specify a larger value for "Candidate level".

Measurement Results for Which Output Is Possible (Model Dictionary)

The following values can be output using processing items related to results output. It is also possible to reference measurement values from expressions and other processing units.

Measurement items	Character string	Description
Judgement	JG	Judgement result

Barcode+

This is a processing item for just FZ3-H □□□ series high grade controllers.
Read in barcodes.
Processing can also classify the read-in results.

Used in the Following Case

- To read in barcodes and output them to an external device

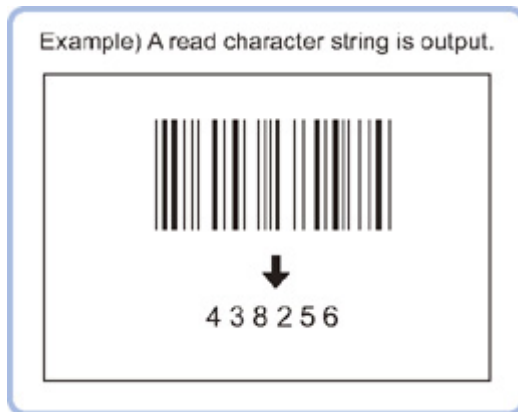

Important

- When FZ3-H□□□ series dedicated processing items are used, processing is carried out that reduces the processing time from the second time on. Therefore, when measuring the same image, the processing for the first time after the controller is started up may be longer than the processing time from the second time on.

Settings Flow (Barcode+)

Barcode+ can be set up as follows.

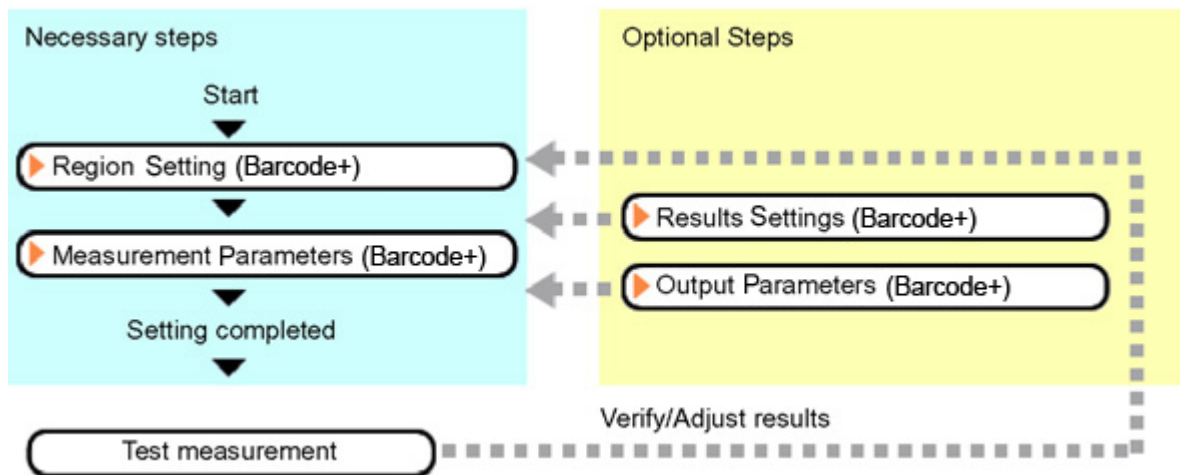

Important

- This processing item is for monochrome only. When using a color camera, insert a color gray filter before this processing item. If a color image is input, it is NG (incompatible image).

List of Barcode+ Items

Item name	Description
Region setting	This item is used to set up the measurement area. Restricting the measurement area can shorten the processing time. Reference: ▶ Region Setting (Barcode+) (p.270)
Measurement	This item specifies the judgement condition for measurement results. Set the code type and the number of characters to be judged as OK. Reference: ▶ Measurement Parameters (Barcode+) (p.271)
Results settings	Set the measurement results. Judgement results can be classified. Reference: ▶ Results Settings (Barcode+) (p.273)
Output parameter	This item can be changed if necessary. Normally, the factory default value will be used. Reference: ▶ Output Parameters (Barcode+) (p.273)

Important

- This processing item is for monochrome only. When using a color camera, insert a color gray filter before this processing item. If a color image is input, it is NG (incompatible image).

Region Setting (Barcode+)

Specify the rectangular area in which to search for the barcodes.
Restricting the measurement area can shorten the processing time.

1. In the Item Tab area, tap [Region setting].
2. Tap [Edit].

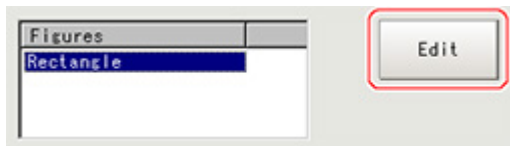

The figure setting area is displayed.

3. Specify the area in which to search for the barcodes.
The rectangle covering the entire screen is set. Adjust the size and position of the rectangle.
4. Tap [OK].
The area to measure is registered.

Important

- Set the region such that the number of pixels in the measurement region is 1920000 pixels or less.
- Set the measurement region such that it contains only 1 barcode.
If there is more than one bar code in the measurement region, measurement may not be performed correctly.
- Set the measurement region such that it includes a quiet zone.

Measurement Parameters (Barcodes+)

This item sets the judgement conditions for measurement conditions and measurement results. When the Teaching button is pressed, the code type and advanced settings are set automatically. If you then tap the Measure button, measurement is executed, the detected barcode region is displayed on the image and the measurement results are displayed as measurement value of the judgement condition.

If measurement cannot be carried out successfully with this procedure, adjust the parameters shown below.

1. In the item tab area, tap [Measurement].
2. In the standard setting area, set the Code Type.

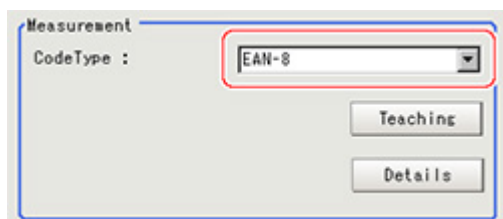

Setting item	Setting value [Factory default]	Description
Code Type	<ul style="list-style-type: none"> • [JAN/EAN-8] • JAN/EAN-8 Add-On 2 • JAN/EAN-8 Add-On 5 • JAN/EAN-13 • JAN/EAN-13 Add-On 2 • JAN/EAN-13 Add-On 5 • UPC-A • UPC-A Add-On 2 • UPC-A Add-On 5 • UPC-E • UPC-E Add-On 2 • UPC-E Add-On 5 • Code39 • Code93 • Code128 • IFT (Interleaved 2of5) • Codabar (NW-7) • GS1 DataBar (RSS-14) • GS1 DataBar (RSS Lim.) • GS1 DataBar (RSS Exp.) • PharmaCode 	Set the code type.

Note

- The designations of the following code types are standardized to those conforming to GS1Databar from 2010.

With FZ3, current designation "GS1Databar" and old designation "RSS" are both indicated.

Select each code type of a new designation conforming to GS1Databar.

GS1 Databar code type new/old comparison table

Code type name	Official name
GS1 DataBar (RSS-14)	GS1 DataBar Omni-directional
GS1 DataBar (RSS Lim.)	GS1 DataBar Limited
GS1 DataBar (RSS Exp.)	GS1 DataBar Expanded

- To teach, tap [Teaching].
The code type and detailed settings are set automatically.
- When making the detailed settings, tap "Details" and set each item.

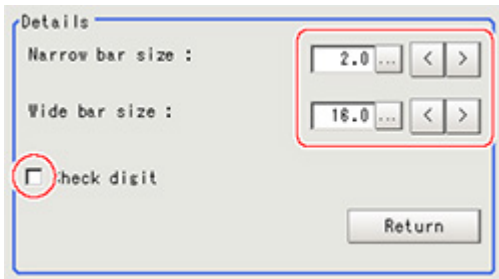

Setting item	Setting value [Factory default]	Description
Narrow bar size	1.5 to 10.0 [2.0]	Specify the minimum width for barcodes. Unit: Pixels
Wide bar size	4.0 to 60.0 [16.0]	Specify the maximum width for barcodes. Unit: Pixels
Check digit	<ul style="list-style-type: none"> • Checked • [Unchecked] 	Specify whether or not to use check digits.

- When changing the display settings, set each item in the "Display setting" area.

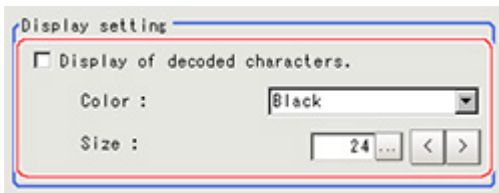

Setting item	Setting value [Factory default]	Description
Color of display	<ul style="list-style-type: none"> • [Black] • White • Red • Green • Blue 	Select the display color for character strings.
Size	10 to 200 [24]	Set the display size for character strings.

- When the setting has been changed, tap [Measurement] in the "Detail" area to verify whether measurements can be made correctly.

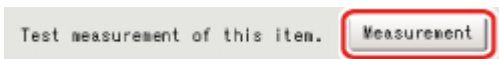

- Set up the judgement condition.

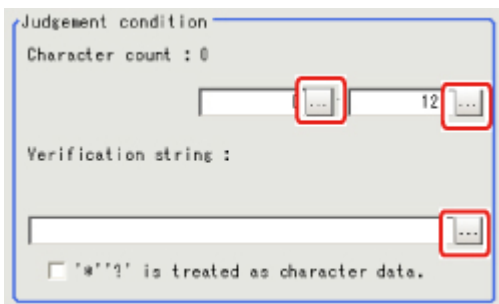

Setting item	Setting value	Description
Character count	0 to 128 [128]	Specify the character count to be judged as OK.
Verification string	Up to 32 characters can be set.	Specify the character strings to be judged as OK.
'*' and '?' are used as character information.	<ul style="list-style-type: none"> • Checked • [Unchecked] 	Checked: '*' and '?' are handled as normal characters. Unchecked: '*' and '?' are handled as special characters. '*': Substitution for character string (with 0 or more characters) '?': Substitution for 1 character

Results Settings (Barcode+)

Results can be classified according to the judgement results.

1. In the Item Tab area, tap [Result setting].
2. Register the character string that will be the reference for classification.

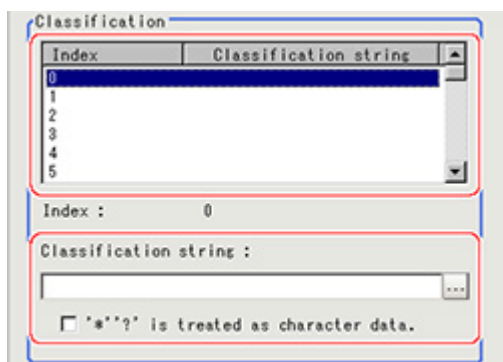

Setting item	Set value	Description
Classification string	-	Set the Verification string.Up to 32 characters can be set.
'*''?' is treated as character data	<ul style="list-style-type: none"> • Checked • [Unchecked] 	Checked: '*' and '?' are handled as normal characters. Unchecked: '*' and '?' are handled as special characters. '*': Substitution for character string (with 0 or more characters) '?': Substitution for 1character

Output Parameters (Barcode+)

Select how measurement results are output to an external device.This item can be changed if necessary.Normally, the factory default value will be used.

1. Tap [Output parameter] in the Item Tab area.

2. Specify each of the following items.

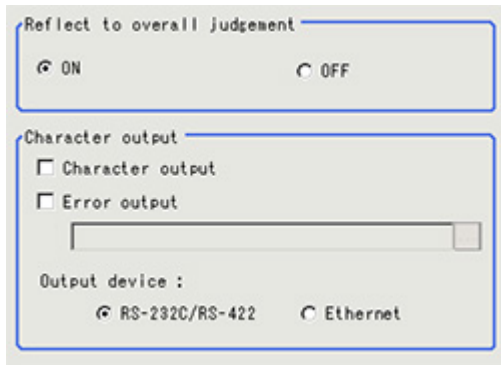

Setting item	Set value [Factory default]	Description
Reflect to overall judgement	<ul style="list-style-type: none"> • [ON] • OFF 	Enables choosing whether or not the judgement results of this processing unit is reflected in the scene overall judgement.
Character output	<ul style="list-style-type: none"> • Checked • [Unchecked] 	Set whether to output character strings.
Error output	<ul style="list-style-type: none"> • Checked • [Unchecked] 	Set whether to output errors.
Error output character string	-	Input the character string output when there is an error. Up to 20 characters can be input.
Output device	<ul style="list-style-type: none"> • [RS-232C/RS-422] • Ethernet 	Set the output destination.

Key Points for Test Measurement and Adjustment (Barcode+)

The following content is displayed in the "Detail result" area as text.

Displayed items	Description
Judge	Judgement result
Index	Index matched as the result of comparison with the classification comparison character strings
Character count	Number of characters detected
Read string	Character strings detected Up to 40 characters are displayed (with a new line after every 15th character). From the 41st character on is displayed as "...". Example) Detected character strings <ul style="list-style-type: none"> • 123456789012345 • 123456789012345 • 1234567890... (□ indicates a double-byte space.)

Key Points for Adjustment

Select the adjustment method referring to the following points.

When the measurement results are unstable

After teaching has been executed, the read-in character contents are different.

Parameter to be adjusted	Remedy
Measurement	<p>The code type may have been detected incorrectly.</p> <ul style="list-style-type: none"> - Select the code type manually, then measure again. - Set the Narrow bar size and Wide bar size in the Advanced setting to match the displayed barcode image, then execute teaching again. - If the bars are too narrow or there is not much difference in density between the background and the image, correct the image with filtering and execute teaching.

Measurement Results for Which Output Is Possible (Barcodes+)

The following values can be output using processing items related to results output. It is also possible to reference measurement values from expressions and other processing units.

Measurement items	Character string	Description
Judgement	JG	Judgement result
Number of decoded character	DN	Number of characters detected
Index	IDX	Index matched as the result of comparison with the classification comparison character strings

About Output at PLC Link

1. About output by barcodes+

If PLC link communication is performed, selecting the "Character output" check box among the Output parameter will cause character string data to be output to the PLC link output area. (FZ3 Ver. 2.10 or later)

If 32 characters are read (read character string: 0123456789...UV), a continuous ASCII code data string is output as shown below.

Output area

Top channel	Name	Output contents
+0ch	1st character, 2nd character	3031 (ASCII code corresponding to character "0," ASCII code corresponding to character "1")
+1ch	3rd character, 4th character	3233 (ASCII code corresponding to character "2," ASCII code corresponding to character "3")
.	.	.
+15ch	31st character, 32nd character	5556 (ASCII code corresponding to character "U," ASCII code corresponding to character "V")

2. How to receive character string data

As you do when serial data is output via PLC link, control the DSA data output request bit and GATE data completion request bit.

Since the entire character string comprises 1 data, DSA control is performed once if there is only 1 barcode+ unit.

2D Code+

This is a processing item for just FZ3-H □□□ series high grade controllers.
Read in 2D codes.
Processing can also classify the read-in results.

Used in the Following Case

- To classify with 2D codes

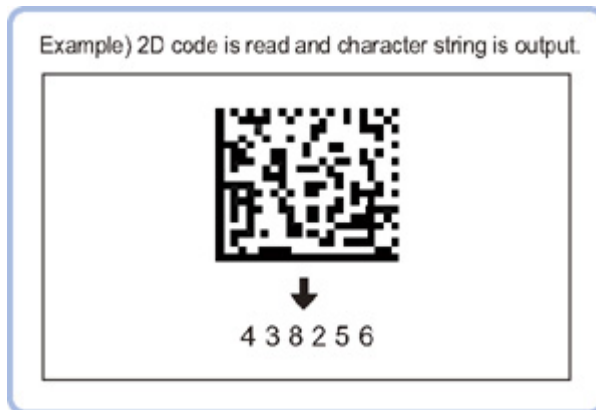

Important

- When FZ3-H□□□ series dedicated processing items are used, processing is carried out that reduces the processing time from the second time on. Therefore, when measuring the same image, the processing for the first time after the controller is started up may be longer than the processing time from the second time on.
- Does not support 2D codes with Japanese included. Supports 2D codes that are composed entirely of ASCII code.
- This processing item is for monochrome only. When using a color camera, insert a color gray filter before this processing item. If a color image is input, it is NG (incompatible image).

Settings Flow (2D Code+)

The setting procedure for 2D Code+ is as follows.

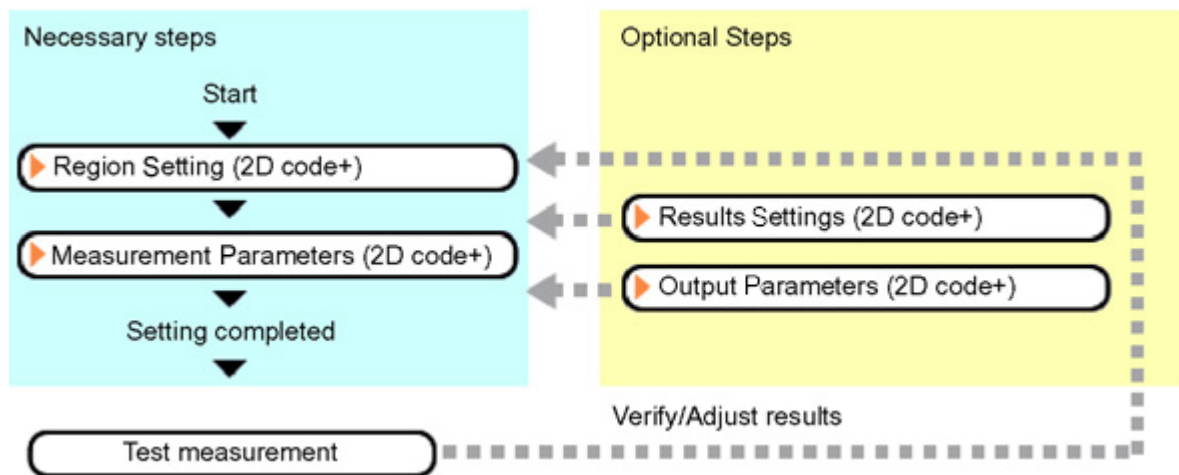

List of 2D Code+ Items

Item name	Description
Region setting	This item is used to set up the measurement area. Restricting the measurement area can shorten the processing time. Reference: ▶ Region Setting (2D Code+) (p.278)
Measurement	This item specifies the judgement condition for measurement results. Set the code type and the number of characters to be judged as OK. Reference: ▶ Measurement Parameters (2D Code+) (p.278)
Results settings	Set the measurement results. Judgement results can be classified. Reference: ▶ Results Settings (2D Code+) (p.280)
Output parameter	This item can be changed if necessary. Normally, the factory default value will be used. Reference: ▶ Output Parameters (2D Code+) (p.280)

Region Setting (2D Code+)

Specify the rectangular area in which to search for 2D codes.
Restricting the measurement area can shorten the processing time.

1. In the Item Tab area, tap [Region setting].
2. Tap [Edit].

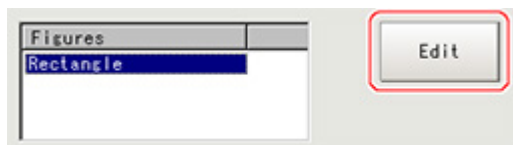

The figure setting area is displayed.

3. Specify the area in which to search for 2D codes.
The rectangle covering the entire screen is set. Adjust the size and position of the rectangle.
4. Tap [OK].
The area to measure is registered.

Important

- Set the region such that the number of pixels in the measurement region is 1920000 pixels or less.
- Set the measurement region such that it contains only 1 2D Codes.
If there is more than one 2D Codes in the measurement region, measurement may not be performed correctly.

Measurement Parameters (2D Code+)

1. In the Item Tab area, tap [Measurement].
2. In the standard setting area, set the Code type.



Setting item	Set value [Factory default]	Description
Code type	<ul style="list-style-type: none"> • [DataMatrix] • QRCode 	Set the code type. The symbol sizes that can be read in are as follows. DataMatrix: Symbol size 48 x 48 max. QRCode: Symbol size 41 x 41 max. (Version 6)
Color	<ul style="list-style-type: none"> • [Black] • White 	Set the color of 2D codes loaded. Black code: Select this for black 2D codes on a white background. White code: Select this for white 2D codes on a black background.

3. Make the display settings for read-in character strings.

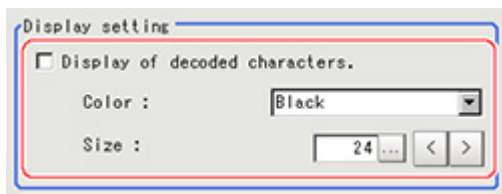

Setting item	Set value [Factory default]	Description
Color	<ul style="list-style-type: none"> • [Black] • White • Red • Green • Blue 	Specify the color of characters displayed on the screen.
Size	10 to 200 [24]	Set the display size for character strings.

4. When the setting has been changed, tap [Measurement] in the Detail area to verify whether measurements can be made correctly.



5. Set up the judgement condition.

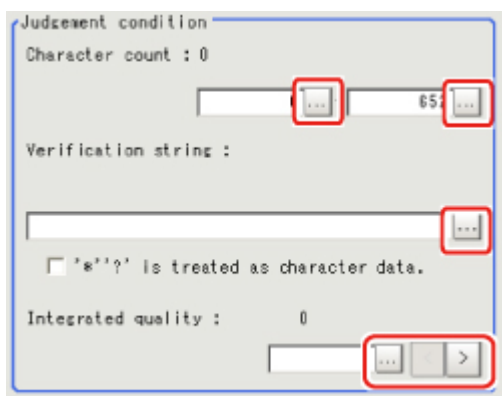

Setting item	Set value	Description
Character count	0 to 652	Specify the number of characters to be judged as OK.
Verification string	-	Specify the classification strings to be judged as OK. Up to 32 characters can be set.

** '?' is treated as character data	<ul style="list-style-type: none"> • Checked • [Unchecked] 	Checked: '*' and '?' are handled as normal characters. Unchecked: '*' and '?' are handled as special characters. '*': Substitution for character string (with 0 or more characters) '?': Substitution for 1 character
Integrated quality	0 to 4	Specify the integrated quality to be judged as OK.

Results Settings (2D Code+)

Results can be classified according to the judgement results.

1. In the Item Tab area, tap [Result setting].
2. Register the character string that will be the reference for classification.

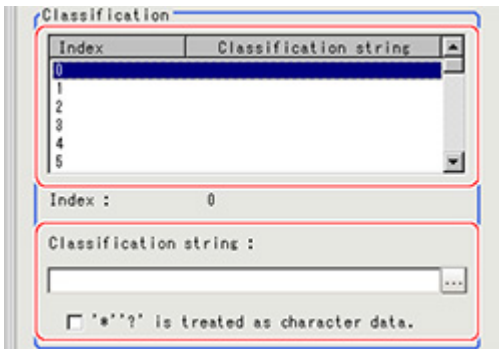

Setting item	Set value	Description
Classification string	-	Set the Verification string.Up to 32 characters can be set.
** '?' is treated as character data	<ul style="list-style-type: none"> • Checked • [Unchecked] 	Checked: '*' and '?' are handled as normal characters. Unchecked: '*' and '?' are handled as special characters. '*': Substitution for character string (with 0 or more characters) '?': Substitution for 1 character

3. If necessary, set the display information for the "Detail result" display area.
 In the grade display, the print quality parameters for 2D codes complying with ISO15415 are displayed.

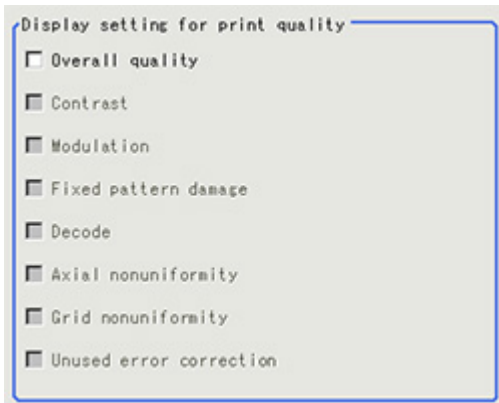

Output Parameters (2D Code+)

Select how measurement results are output to an external device.This item can be changed if necessary.Normally, the factory default value will be used.

1. Tap [Output parameter] in the Item Tab area.
2. Specify each of the following items.

Setting item	Set value [Factory default]	Description
Reflect to overall judgement	<ul style="list-style-type: none"> • [ON] • OFF 	Enables choosing whether or not the judgement results of this processing unit is reflected in the scene overall judgement.
Character output	<ul style="list-style-type: none"> • Checked • [Unchecked] 	Set whether to output character strings.
Error output	<ul style="list-style-type: none"> • Checked • [Unchecked] 	Set whether to output errors.
Error output character string	-	Input the character string output when there is an error. Up to 20 characters can be input.
Output device	<ul style="list-style-type: none"> • [RS-232C/RS-422] • Ethernet 	Set the output destination.

Key Points for Test Measurement and Adjustment (2D Code+)

The following content is displayed in the "Detail result" area as text.

Displayed items	Description
Judge	Judgement result
Index	Index matched as the result of comparison with the classification comparison character strings
Character count	Number of characters detected
Read string	Character strings detected

The display items checked in the result settings tab Grade display setting are displayed.

The grade code is displayed with a letter with numeric expression in parentheses, such as "A (4) to F (0)".

Key Points for Adjustment

Select the adjustment method referring to the following points.

When the measurement results are unstable

When codes cannot be read in correctly

Parameter to be adjusted	Remedy
Region setting	Check whether there are codes to read in the measurement region.
Measurement	Check whether "Code type" and "Color" has been set correctly.

Measurement Results for Which Output Is Possible (2D Codes+)

The following values can be output using processing items related to results output. It is also possible to reference measurement values from expressions and other processing units.

Measurement items	Character string	Description
Judgement	JG	Judgement result
Number of decoded characters	DN	Number of decoded characters
Index	IDX	Index matched as the result of comparison with the classification comparison character strings
Integrated quality	G0	Integrated quality
Contrast	GD1	Contrast
Modulation	GD2	Modulation
Fixed pattern damage	GD3	Fixed pattern damage
Decode	GD4	Decode
Axis non-uniformity	GD5	Axis non-uniformity
Grid non-uniformity	GD6	Grid non-uniformity
Correction of error not used	GD7	Correction of error not used

About Output at PLC Link

1. About output by 2D codes+

If PLC link communication is performed, selecting the "Character output" check box among the Output parameter will cause character string data to be output to the PLC link output area. (FZ3 Ver. 2.10 or later)

If 32 characters are read with ASCII code (read character string: 0123456789...UV), a continuous ASCII code data string is output as shown below.

Output area

Top channel	Name	Output contents
+0ch	1st character, 2nd character	3031 (ASCII code corresponding to character "0," ASCII code corresponding to character "1")
+1ch	3rd character, 4th character	3233 (ASCII code corresponding to character "2," ASCII code corresponding to character "3")
.		
.		
.		
+15ch	31st character, 32nd character	5556 (ASCII code corresponding to character "U," ASCII code corresponding to character "V")

Shift-JIS and other 2-byte characters can be output by a total of 16 characters, with 1 character output to each channel.

2. How to receive character string data

As you do when serial data is output via PLC link, control the DSA data output request bit and GATE data completion request bit.

Since the entire character string comprises 1 data, DSA control is performed once if there is only one 2D codes+ unit.

Circle Angle

Used in the Following Case

- To correct the tilting of circle measurement objects

Example) Appearance measurement while correcting the nut rotation

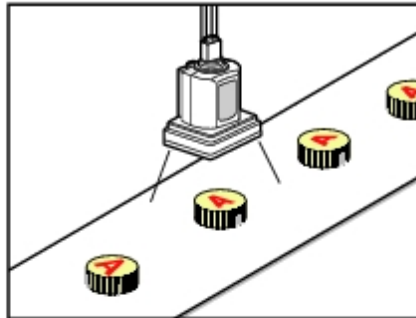

Draw a circle to encircle the part that has the basic features of the image in order to define the registering conditions for featured points/measured points.



Based on the conditions defined on the controller, inspect the featured points on the circumference with the pixel unit, which will be registered as the reference position.



x x (Featured points for the reference position)

Reference image



Input image

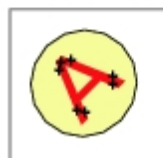

The degree of angle is calculated by comparing the featured points of the reference image with those of the input image.

Note

- The center position of the measured object should be always fixed in order to efficiently use the Circle Angle. Prior to Circle Angle, processing items related to position correction should be performed, making the central coordinates of the measurement object stay at a fixed position. Example)

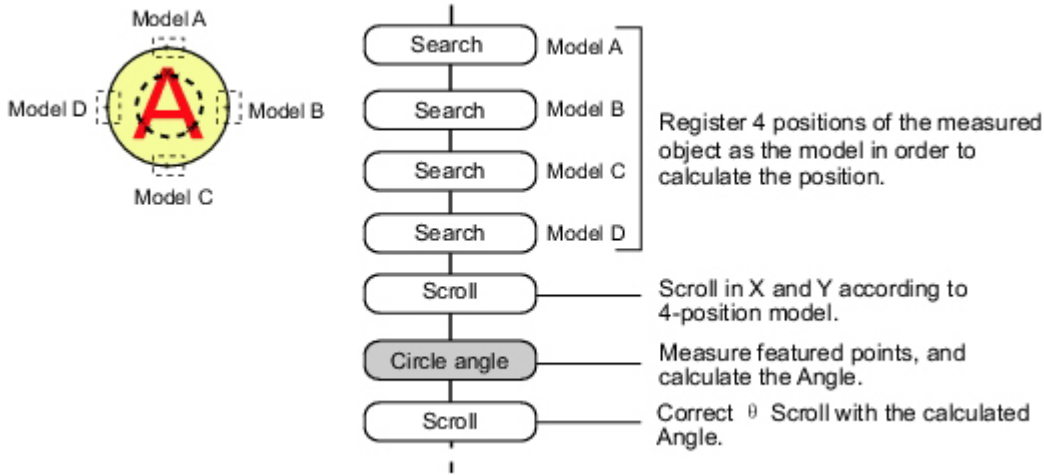

Settings Flow (Circle Angle)

The Circle Angle should be set up with the following procedure.

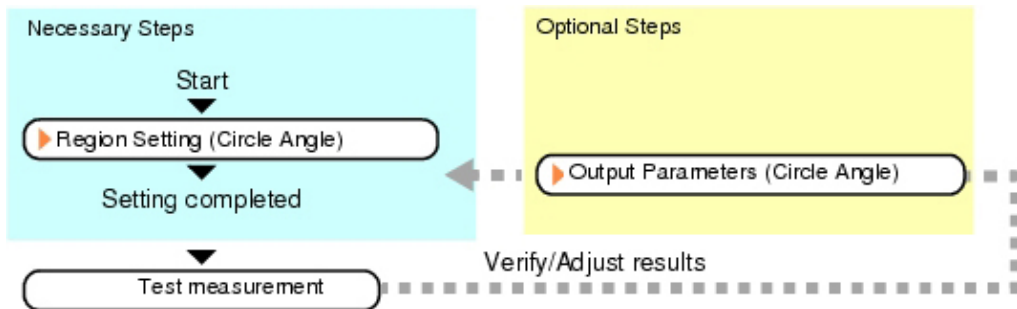

List of Circle Angle Items

Item name	Description
Region setting	This item is used to set up the measurement area. Instead of measuring the entire input image, narrowing the measurement area shortens the processing time. If measurement results are unstable, change detection conditions as needed. Normally, the factory default value will be used. Reference: ▶ Region Setting (Circle Angle) (p.286)
Output parameter	This item can be changed if necessary. Normally, the factory default value may be used. Select the measurement result coordinates and set how to handle the coordinates. Reference: ▶ Output Parameters (Circle Angle) (p.288)

Region Setting (Circle Angle)

This item is used to set up the measurement area. This item specifies the measurement region for [Circle Angle] with a circle. Ellipses cannot be set. If measurement results are unstable, change detection conditions as needed.

Note

- When drawing the measurement region, the featured part should lie on the circumference.



- In the Item Tab area, tap [Region setting].
- Use the Drawing tools to specify the measurement region.

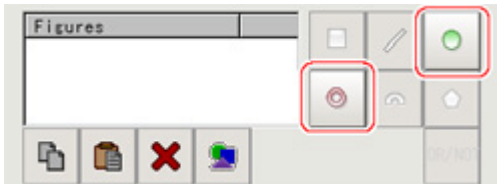

- In the figure setting area, tap [OK].
The measurement region is registered and displayed in the Image Display area.



- If necessary, set a value for each item in the "Measurement condition" area.
After changing a setting, check whether measurement can be done properly by performing an actual measurement.

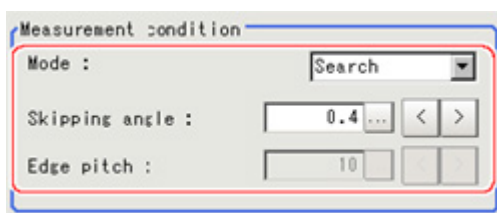

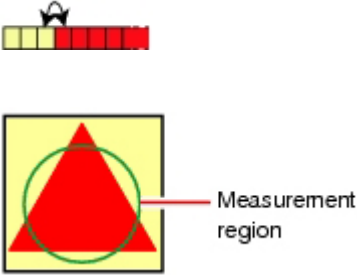
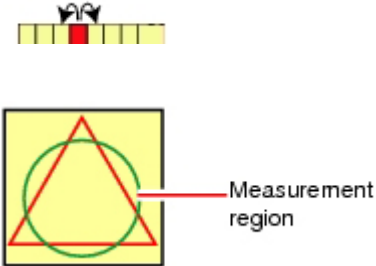
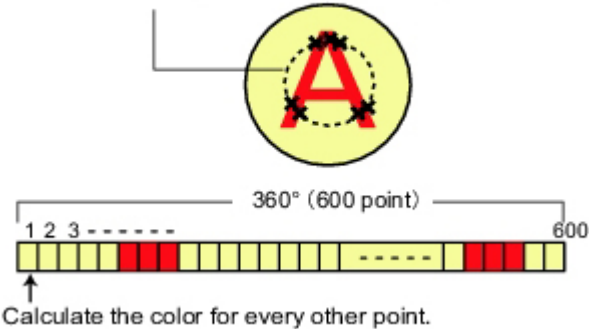
Setting item	Set value [Factory default]	Description
Mode	[Search]	This option compares the color difference with the surrounding pixels and determines the angle based on the color information.
	Edge	<p>The angle is determined based on the position of the points with a large color difference from the neighboring pixels [Note 1]. This mode is suitable for the following types of measurement objects.</p> 
	Defect	<p>The angle is determined based on the position of the points with a large color difference from the surrounding pixels [Note 1]. This mode is suitable for the following types of measurement objects.</p> 
Skipping angle	0.1 to 10 [0.4]	<p>Specify the interval degrees for extracting points. The color of all the points on the circumference (360° circumference/skipping angle) corresponding to the set skipping angle.</p> <p>Example) When the scale unit is 0.6° Measure 600 point on this line in the pixel unit.</p>  <p>For the initial setting, the optimal value will be automatically set up based on the radius of the drawn circle. The bigger the value set, the faster the processing, but the lower the detection angle and rotation precision.</p>
Edge pitch	1 to 99 [10]	<p>Specify the spacing for calculating the color difference. This item is enabled only when "Mode" is set to "Edge" or "Defect".</p>

[Note 1]: Comparison is with the pixel separated by exactly the comparison interval (the value set in "Edge Pitch").

Output Parameters (Circle Angle)

Specify how to treat the coordinates to be output to the external device as measurement results. This item can be changed if necessary. Normally, the factory default value will be used.

Important

- After setting up the measurement parameters, changing the output parameters will cause measurement results to vary accordingly. If the output parameters have been changed, re-specify the measurement, too.

- Tap [Output parameter] in the Item Tab area.
- Set up each item.

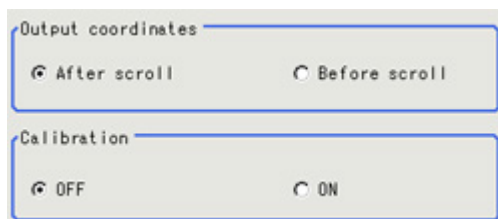

Setting item	Set value [Factory default]	Description
Output Coordinates	<ul style="list-style-type: none"> [After scroll] Before scroll 	As measurement results, select whether to output coordinate values to external devices before or after the position deflection correction is applied.
Calibration	<ul style="list-style-type: none"> [OFF] ON 	Select whether to reflect the calibration in the values output to the external device as measurement results. ON: Output the coordinates converted into actual dimensions. OFF: Output the camera coordinate values.

Key Points for Test Measurement and Adjustment (Circle Angle)

The following content is displayed in the "Detail result" area as text.

Displayed items	Description
Judgement	Judgement result
Rotation angle	Measured Angle
Center position X	Center position X of circle in measurement results
Center position Y	Center position Y of circle in measurement results
Reference angle	Angle of the circle drawn as the measurement region
Reference X	Reference position X of the circle drawn as the measurement region
Reference Y	Reference position Y of the circle drawn as the measurement region

Key Points for Adjustment

Select the adjustment method referring to the following points.

When the measurement results are unstable

Parameter to be adjusted	Remedy
Region setting	Specify a smaller value for the "Skipping angle".
Measurement flow	When the center position of measurement objects is not fixed, add position compensation to the flow so that the central coordinates of the measurement objects give a fixed position.

When the processing speed is slow

Parameter to be adjusted	Remedy
Region setting	Specify a larger value for the "Skipping angle".
	Set the "Mode" to "Edge" or "Defect".

Measurement Results for Which Output Is Possible (Circle Angle)

The following values can be output using processing items related to results output. It is also possible to reference measurement values from expressions and other processing units.

Measurement items	Character string	Description
Judgement	JG	Judgement result
Center position X	X	Center position X of circle in measurement results
Center position Y	Y	Center position Y of circle in measurement results
Rotation angle	TH	Angle of measurement results Output range -180 ° to 180 °
Reference position X	SX	Reference position X of the circle drawn as the measurement region [Note 1]
Reference position Y	SY	Reference Y of the circle drawn as the measurement region [Note 1]
Reference angle	ST	Angle drawn as the measurement region

[Note 1]: Since measuring is performed at the same position every time for Circle Angle, "Center X = Reference SX, Center Y = Reference SY".

Compensate image

This chapter describes how to apply positional compensation for measurement objects in the input image in order to measure accurately.

- ▶ Reference: Position Compensation (p.292)
- ▶ Reference: Trapezoidal Correction+ (p.296)
- ▶ Reference: Filtering (p.304)
- ▶ Reference: Background Suppression (p.309)
- ▶ Reference: Color Gray Filter (p.312)
- ▶ Reference: Extract Color Filter (p.316)
- ▶ Reference: Anti Color Shading (p.321)
- ▶ Reference: Stripes Removal Filter+ (p.324)
- ▶ Reference: Halation Cut+ (p.327)
- ▶ Reference: Panorama+ (p.330)
- ▶ Reference: Polar Transformation (p.336)

Position Compensation

The positional deviation of measurement objects can be corrected using measured values saved by other processing units. Compare the measured coordinates with the reference coordinates of the applicable processing unit, and move the image by the amount of the difference.

Used in the Following Case

- Even with different positions for the same measurement object, correct measurement can still be performed by correcting the position of the input image. There is no need to reposition the measurement object itself.

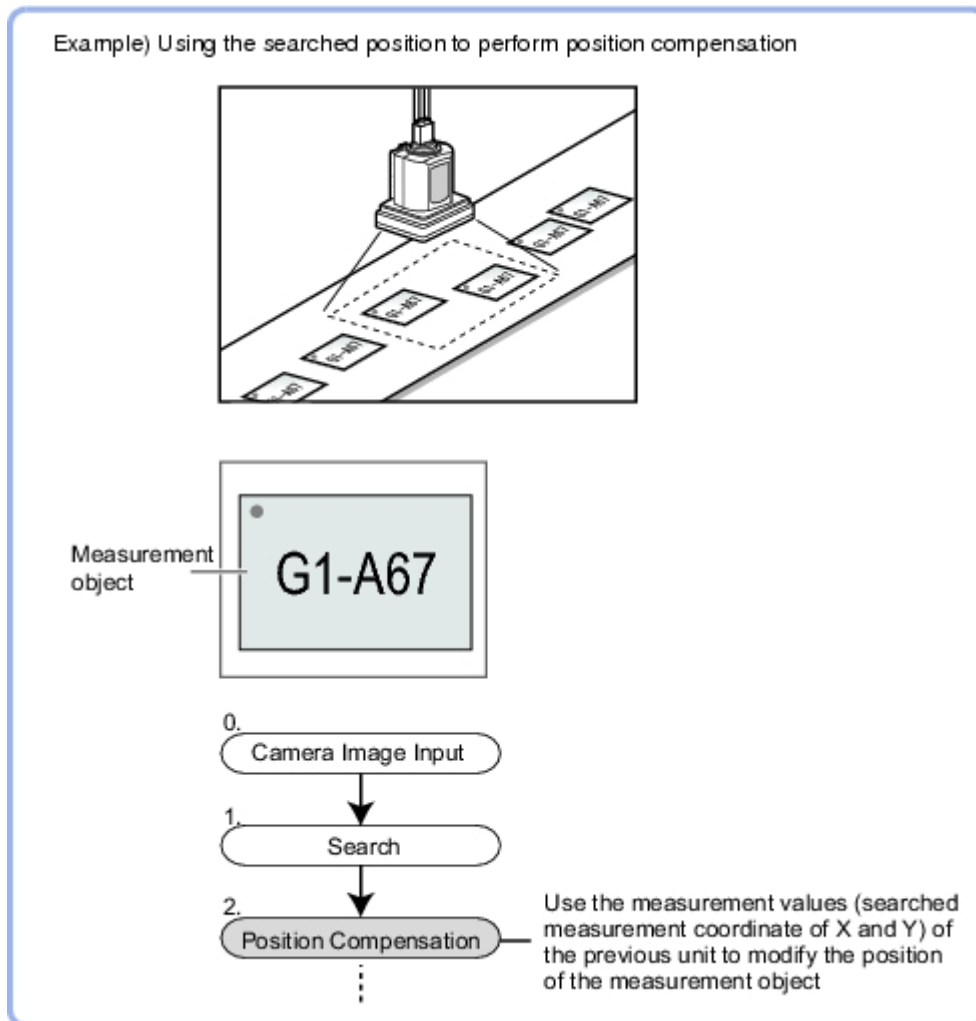

Processing Units That Can Be Combined with Position Compensation

Position compensation corrects positions according to measured values (coordinates) from the immediately preceding processing unit. Combining the following processing units with position compensation is effective.

Processing unit type	Processing item name
Processing unit that performs search or matching (called "Search processing unit" hereafter.)	Reference: ▶ Search (p.48) Reference: ▶ Flexible Search (p.59) Reference: ▶ ECM Search (p.79) Reference: ▶ Circle Angle (p.284)
Processing unit that detects edge positions (called "Edge position processing unit" hereafter.)	Reference: ▶ Edge Position (p.120) Reference: ▶ Scan Edge Position (p.138)
Processing unit to detect the center of gravity (called "processing unit for gravity center detection".)	Reference: ▶ Gravity and Area (p.168) Reference: ▶ Labeling (p.180)

Important

- When the position compensation method ([Method]) is set to [1 unit scroll] or [2 unit scroll], position compensation will not be performed correctly if units other than the above unit(s) are present immediately before the [Position Compensation] unit within the scene.
- For processing units that are used in combination with position compensation, set [Calibration] to "OFF" in [Output parameter].
- The position compensation method causes some processing items to be NG when areas outside the image are included within the region. (Edge position/number of edge pins/fine matching/defects and contamination/high-precision defects and contamination detection/area gravity center/labeling/sophisticated labeling+/color average and deviation/scan edge position/scan edge width/circular shape angle acquisition)

Region Compensation (Position Compensation)

When position compensation is set, the position is shifted by exactly the amount of the compensation, then measurement is performed. Restricting the region in which the image is moved can shorten the processing time.

1. In the Item Tab area, tap [Region setting].
2. Use the Drawing tools to specify the measurement region.

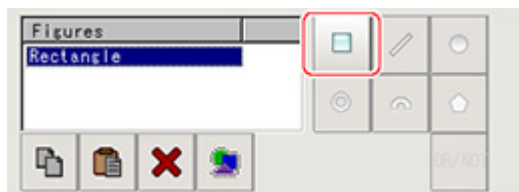

3. In the figure setting area, tap [OK].
The range in which to perform position compensation is registered.

Scroll Method (Position Compensation)

Set the compensation method for position compensation.

1. In the Item Tab area, tap [Scroll method].

2. Set the parameters.

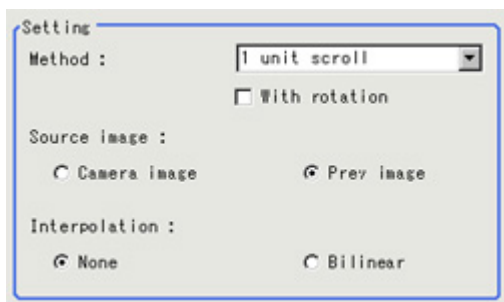

Setting item	Set value [Factory default]	Description
Method	[1 unit scroll]	This performs a position compensation by referring to the coordinates measured with the search processing unit or edge position processing unit [Note 1] immediately before the [Position Compensation] (automatic processing unit). This moves the image by the difference between the measured coordinates and the reference coordinates of the referring search processing unit or edge position processing unit.
	2 unit scroll	This performs a position compensation by referring to the coordinates measured with the search processing unit or edge position processing unit [Note 1] immediately before or two units before the [Position Compensation] (automatic processing unit).
	Calculation	Set whichever position compensation you prefer. Set the reference coordinates and measurement coordinates.
	Reset scroll	The image for the immediately preceding image input (Camera image input/Camera switching) is displayed. When position compensation has been performed, the status returns to that from before position compensation. If Filtering or Color Gray Filter had been performed, the original image with Filtering or Color Gray Filter released is displayed.
With rotation	<ul style="list-style-type: none"> • Checked • [Unchecked] 	When "1 unit scroll" or "2 unit scroll" is selected as the setting method, place a check for executing position compensation in the rotation direction in addition to the XY directions.
Source image	Camera image	The camera input image that has not been subject to filtering is subject to compensation as is.
	[Prev image]	Images to which filtering and position compensation processing are applied in units even before the "Position Compensation" being set are the targets.
Interpolation	[None]	Position compensation is performed in units of pixels.
	Bilinear	This option joins more than one point with a line in order to find a desired approximate value. The image will become smoother.

[Note 1] Reference: ▶ Processing Units That Can Be Combined with Position Compensation (p.292)

[When you choose the "Calculation" option](#)

3. Using expressions, specify the "Reference" and "Position" which are used to determine the

position compensation.

Differences between the respective values in the "Reference" and "Position" areas give the amount of position compensation to be performed.

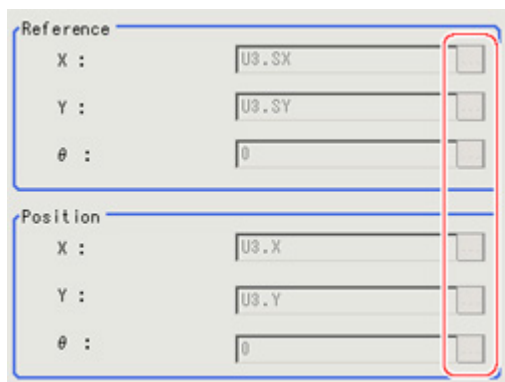

Reference: ▶ Layout of Setting Expression Window (p.343)

Measurement Results for Which Output Is Possible (Position Compensation)

The following values can be output using processing items related to results output. It is also possible to reference measurement values from expressions and other processing units.

Measurement items	Character string	Description
Judgement	JG	Judgement result
Scroll X	DX	Scroll X
Scroll Y	DY	Scroll Y
Scroll θ	DT	Scroll θ
Measurement coordinate X	X	Measured value X coordinate
Measurement coordinate Y	Y	Measured value Y coordinate
Measurement angle	TH	Measure angle
Reference position X	SX	Reference X coordinate
Reference position Y	SY	Reference Y coordinate
Reference angle	ST	Reference angle

Trapezoidal Correction+

This is a processing item for just FZ3-H □□□ series high grade controllers.

If measurement is performed with the measurement object tilted or the camera tilted, the input image is converted to orthogonal coordinates.

Used in the Following Case

- Processing a trapezoidal image shot tilted to make it easier to inspect

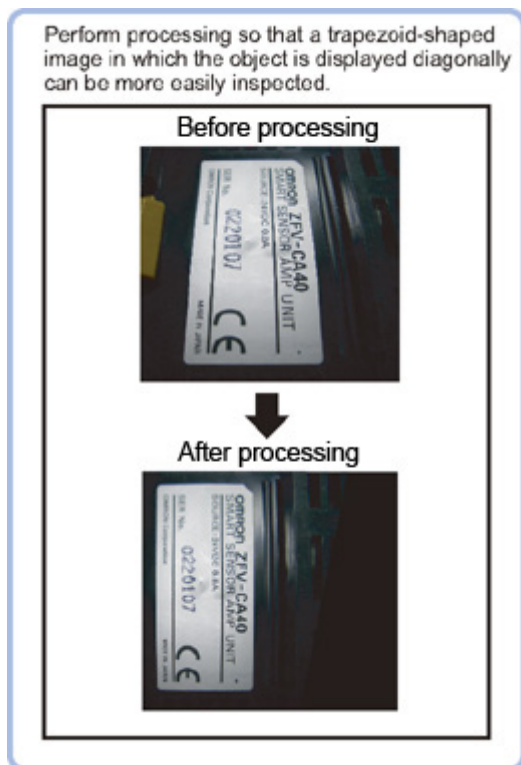

Important

- When FZ3-H □□□ series dedicated processing items are used, processing is carried out that reduces the processing time from the second time on. Therefore, when measuring the same image, the processing for the first time after the controller is started up may be longer than the processing time from the second time on.

Conversion Method (Trapezoidal Correction+)

Set the input image conversion method.

- In the Item Tab area, tap [Conv. method].
When making a new setting, you do not need to tap [Conv. method].
- As necessary, set the parameters.

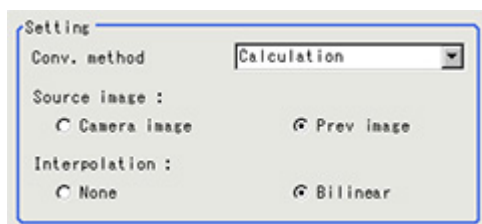

Setting item	Set value [Factory default]	Description
Conv. method	<ul style="list-style-type: none"> 4 unit reference [Calculation] 	<p>Set the expression used for image conversion</p> <p>4-unit reference: The parameters are set referencing the reference coordinates and measurement coordinates for the immediately preceding 4 units.</p> <p>To set the reference position and measurement position with 4-unit reference, it is necessary to set the measurement position setting method to expression. To modify the expression for the reference position and measurement position set with 4-unit reference, select the Expression.</p>
Source image	<ul style="list-style-type: none"> Camera image [Prev image] 	Set the image to be compensated.
Interpolation	<ul style="list-style-type: none"> None [Bilinear] 	<p>Set the interpolation between pixels for image conversion.</p> <p>To reduce conversion time more than raise compensation precision, set "None".</p>

3. Set the reference position.

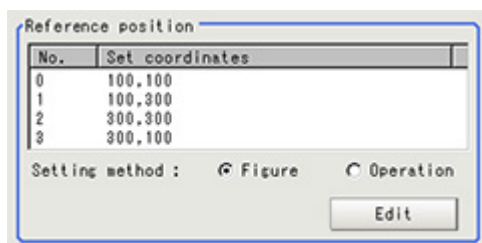

Setting item	Set value [Factory default]	Description
Setting method	<ul style="list-style-type: none"> [Figure] Operation 	<p>Set the method for setting the reference position.</p> <p>When fixed value is selected, specify the vertex position on the image.</p> <p>After setting with an expression, if the setting is changed to a fixed value, the result of the expression is reflected as a fixed value.</p>

When Expression is chosen

Tap [Edit].

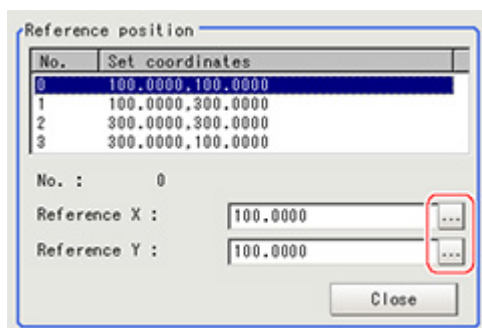

Tap [...] and set the expression.

Reference: ▶ Layout of Setting Expression Window (p.343)

4. Set the measurement position.

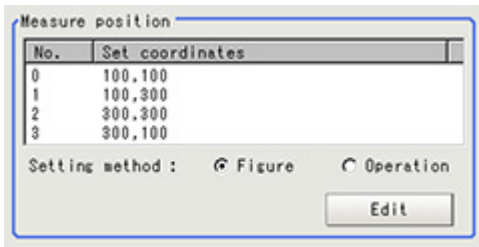

Setting item	Set value [Factory default]	Description
Setting method	<ul style="list-style-type: none"> · [Figure] · Operation 	<p>Set the method for setting the measurement position.</p> <p>When fixed value is selected, specify the vertex position on the image.</p> <p>After setting with an expression, if the setting is changed to a fixed value, the result of the expression is reflected as a fixed value.</p>

When Expression is chosen

Tap [Edit].

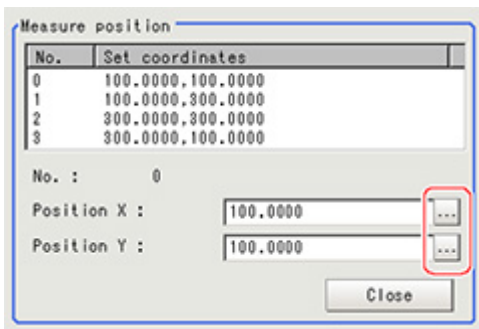

Tap [...] and set the expression.

Reference: ▶ Layout of Setting Expression Window (p.343)

5. Set the display settings as necessary.



Example of Setting

Here, the following two patterns for setting the reference position and measurement position are described.

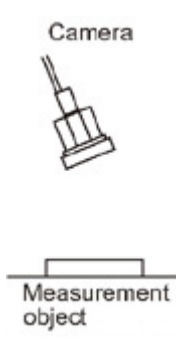
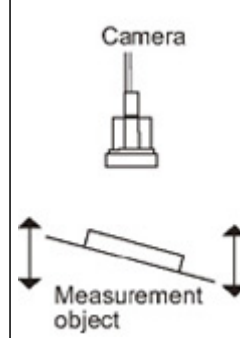
	Pattern 1	Pattern 2
Setting item	Camera: Fixed tilt Work: No chatter 	Camera: Fixed vertical Work: Chatter 
Reference position	Figure	Figure
Measurement position	Figure	Expression

Pattern 1:

When the camera is installed tilted and there is no chatter in the work

- Reference: ▶ See the setting example (p.299) for when there is no chatter in the work

Pattern 2:

When the camera is installed vertical and there is chatter in the work

- Reference: ▶ See the setting example (p.301) for when there is chatter in the work.

Setting Example for when There Is No Chatter in the Work

Even when there is a mechanical structure and the camera cannot be installed from the front, 4-point position information can be used to compensate for distortion in the image. When you specify the four points used for distortion compensation and specify the positions where those four points should be as reference positions, the parameters for distortion compensation are set automatically. Each time a measurement is made, the distortion is automatically compensated for using these parameters.

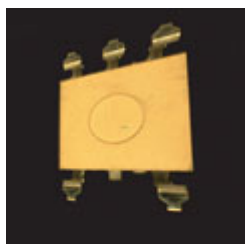

Crooked image



After revision

1. Select "Figure" for the measurement position and tap Edit.

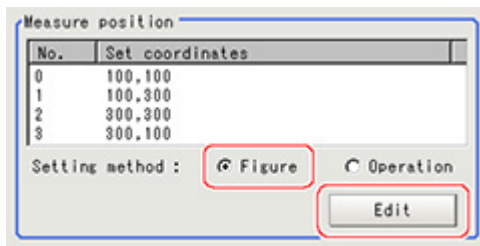

2. Specify on the image which four points whose information to use for distortion compensation.

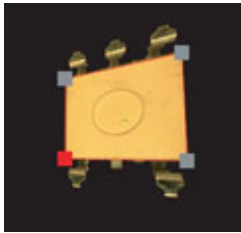

3. Select "Figure" for the reference position and tap Edit.

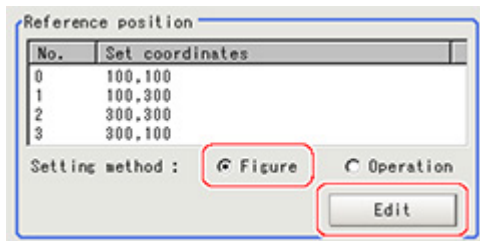

4. On the image, specify which information for the positions where the four specified points should be to use for distortion compensation.

When concrete coordinate positions are known or to measure them and find accurate positions, it is possible to set "Expression" and substitute measurement values from other processing units.



5. Place a check at "Filtered image" in the display settings and check the image in which the distortion has been compensated for.



Setting Example for when There Is Chatter in the Work

Even when there is chatter in the work during transport and error is generated in the distance to the camera, 4-point position information can be used to compensate for distortion in the image. Preset in other units so that when you specify the positions where the four points used for distortion compensation should be as reference positions, the 4-point position information can be acquired. Compensate for the distortion in the image so that the position information for the four points aligns with the reference positions when measurements are made. With this setting, 3D position deviation can be compensated for.

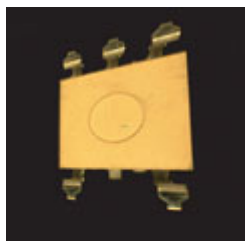

Crooked image



After revision

1. Select "Operation" for the measurement position and tap Edit.

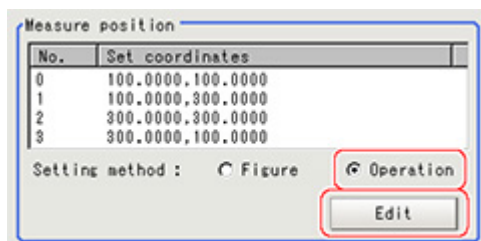

2. Specify with the expression which four points to use the information of for compensation. Set the processing unit for acquiring the positions before the processing unit for trapezoidal distortion compensation.

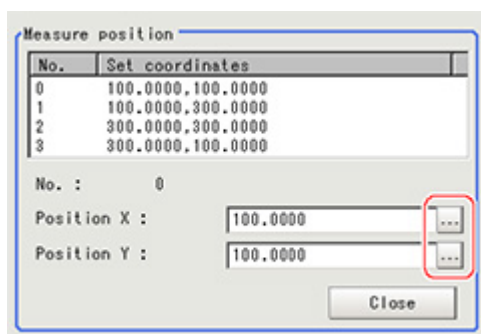

3. Select "Figure" for the reference position and tap Edit.

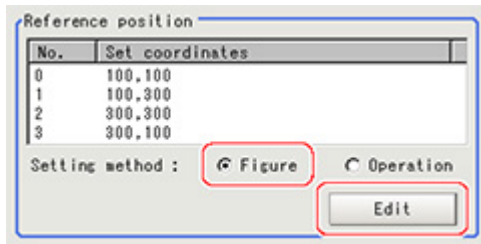

4. On the image, specify which information for the positions where the four specified points should be to use for distortion compensation.
When concrete coordinate positions are known or to measure them and find accurate positions, it is possible to set "Operation" and substitute measurement values from other processing units.

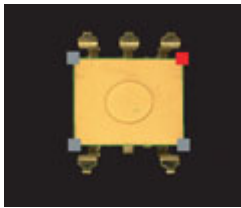

5. Place a check at "Conversion image" in the display settings and check the image in which the distortion has been compensated for.



Region Setting (Trapezoidal Correction+)

Specify as a rectangle the range for compensating in the image.

Narrowing the compensation range instead of measuring the entire input image shortens the processing time.

1. In the Item Tab area, tap [Region setting].
2. Tap [Edit].

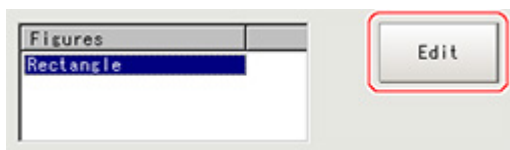

The figure setting area is displayed.

3. Specify the area in which to search for the model.
The rectangle covering the entire screen is set. Adjust the size and position of the rectangle.
4. Tap [OK].
The area to measure is registered.

Key Points for Test Measurement and Adjustment (Trapezoidal Correction+)

The following content is displayed in the "Detail result" area as text.

Displayed items	Description
Judge	Judgement result

Measurement Results for Which Output Is Possible (Trapezoidal Correction+)

The following values can be output using processing items related to results output. It is also possible to reference measurement values from expressions and other processing units.

Measurement items	Character string	Description
Judgement	JG	Judgement result

Filtering

Process the images acquired from cameras in order to make them easier to measure.

Used in the Following Case

- Cutting out unnecessary background images to exclude them from the measurement region

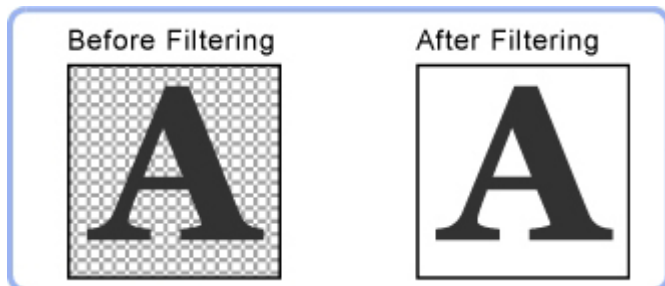

- When noise is to be removed

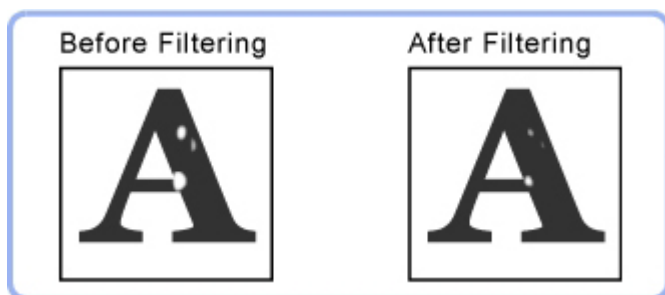

- When the edges of marks you want to find cannot be found even though other edges have been extracted.

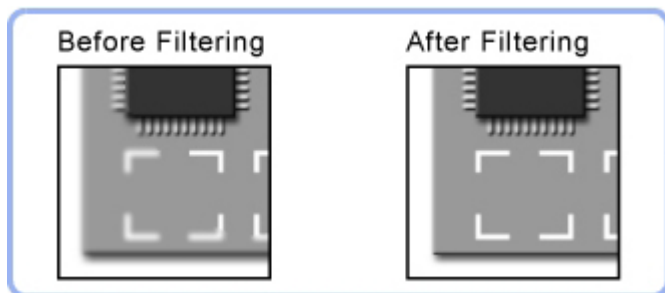

Filtering Parameters (Filtering)

Treat the images loaded from the camera in order to make them easier to measure. You can select from 10 filtering methods to match the image state.

1. In the Item Tab area, tap [Filter parameter].

2. Set each item while checking the image.

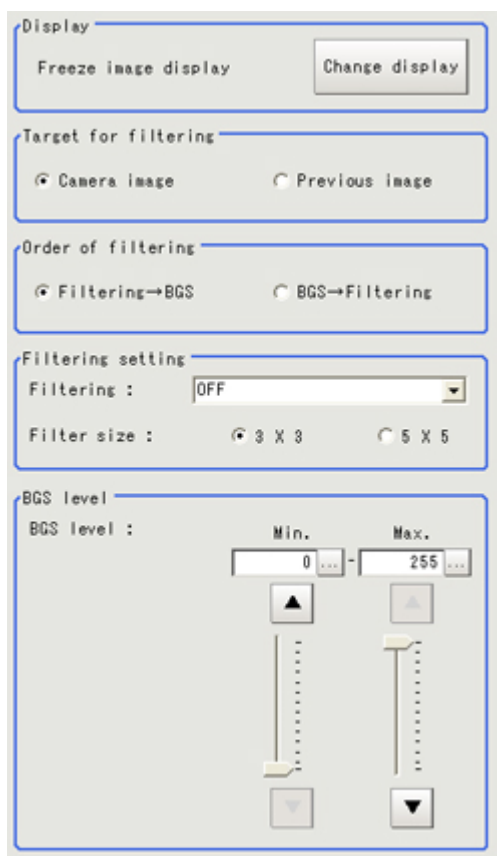

Setting item	Set value [Factory default]	Description
Display	Through image display	The latest image is always input from the camera and displayed.
	[Freeze image display]	The image that was scanned in the immediately preceding measurement is displayed. Images can be updated at any time during measurement.
Target for filtering	[Camera image]	Filtering is applied to the images input from the camera that is set before this unit ([Filtering]) in the scene. Filtering is not performed.
	Previous image	Filtering is applied to the images which have been processed by the [Position Compensation] and [Filtering] units that are set before this unit ([Filtering]) in the scene.
Order of filtering	<ul style="list-style-type: none"> · [Filtering → BGS] · BGS → Filtering 	Select the sequence of background suppression/filtering.

Filtering	<ul style="list-style-type: none"> • [OFF] • Weak smoothing • Strong smoothing • Dilate • Erosion • Median • Extract edges • Extract vertical edges • Extract horizontal edges • Enhance edges 	Select the type of filtering. Reference: ▶ Filtering options and examples (p.306)
Filter size	<ul style="list-style-type: none"> • [3 × 3] • 5 × 5 	Select whether to use information from several surrounding pixels. With mask size, the larger the setting value, the more of the surrounding pixel variation that can be assimilated.
BGS level	[0] to [255]	While looking at your image, specify the upper and lower limits for RGB to suppress as the background. Reference: ▶ Background suppression level (p.307)

Filtering Options and Examples

Treat the images loaded from the camera in order to make them easier to measure.

Types of filtering	The problems to be treated	Filtering description	Example
Weak smoothing Strong smoothing	Small flecks on the measurement object	Makes flecks less visible.	Makes stable searching possible and stable area measurement possible.
Dilate	Dark noise exists	This filtering removes dark noise by enlarging brighter areas.	Measurement object noise removal
Erosion	Brighter noise exists	This filtering removes brighter noise by shrinking brighter areas.	
Median	Small flecks on the measurement object	This filtering keep the profile and weaken flecks.	Edge positioning (Accuracy is not reduced)
Extract edges	Due to a comparatively lower image contrast, defects are difficult to extract	Extracts the boundary lines of the image (light and shade).	Defect inspection
Extract vertical edges	Due to a comparatively lower image contrast, defects are difficult to extract	Extracts the boundary lines vertical to the image (light and shade).	
Extract horizontal edges	Due to a comparatively lower image contrast, defects are difficult to extract	Extracts the boundary lines horizontal to the image (light and shade).	

Enhance edges	The measurement object is blurry (due to changes such as lighting fluctuation).	Clearly delineates the boundary lines between the light and dark in the image.	Edge positioning
---------------	---	--	------------------

Notes on Filtering Setting

If filtering is applied to the image, the area around the image frame will become unstable. When a [Filtering] processing item has been set in the scene, ensure that measurement ranges, etc. set for other processing items are not included in the area around the image frame.

The width not included in the measurement range will vary depending on the mask size settings.

- Filter size: 5 x 5

Make settings so that a width around the image frame equal to 2 pixels is not included in the measurement range.

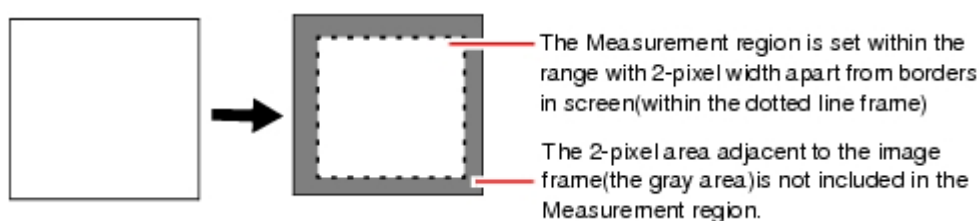

- Filter size: 3 x 3

Make settings so that a width around the image frame equal to 1 pixels is not included in the measurement range.

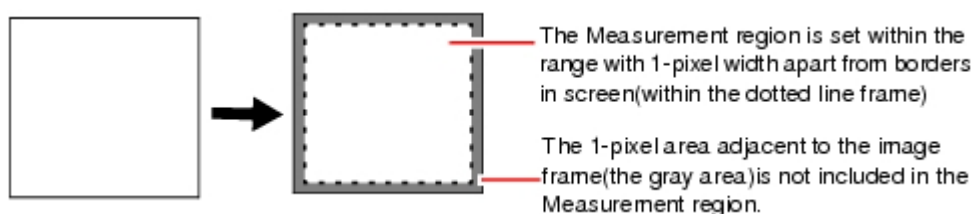

When a partial scan is used to limit the load range

Set so as to not include the image loading range surroundings.

The width that will not be included in the measurement range is the same as the above. (In the following figure, filter size: 5 x 5).

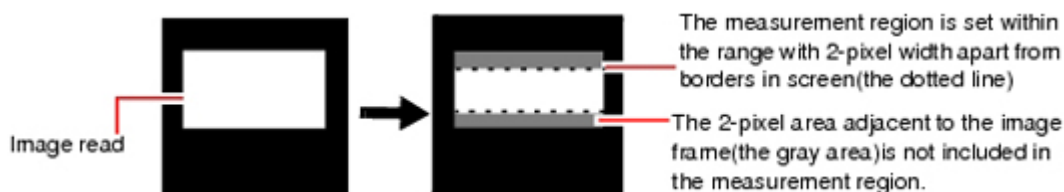

Background Suppression Level

The images below the lower limit and above the upper limit will be set to the lower and upper limits of brightness, respectively.

Example) lower limit: 100 upper limit: 220

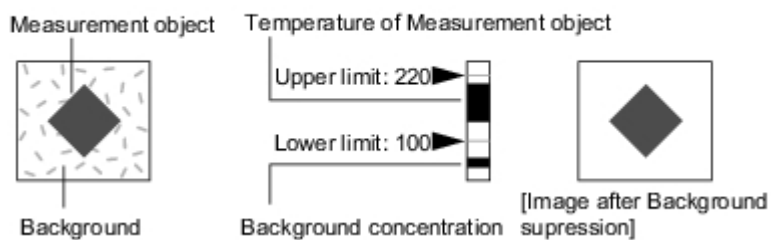

Only images with a density of 100 to 220 can be measurement objects.

Region Setting (Filtering)

It is possible to target the entire screen, but restricting the range can shorten the processing time.

1. In the Item Tab area, tap [Region setting].
2. Use the Drawing tools to specify the measurement region.

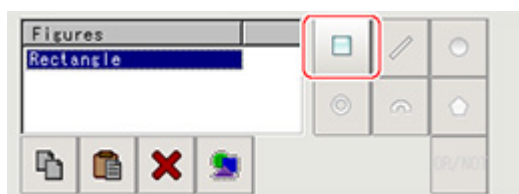

3. In the figure setting area, tap [OK].
The area in which to perform filtering is registered.

Background Suppression

Specifying a brightness range to use for measurement eliminates the section outside that range as background.

In addition, the extracted range is converted into values of 0 to 255, so the contrast can be emphasized.

Used in the Following Case

- By extracting a specific brightness range, the contrast on the image can be improved, unnecessary background eliminated, etc.

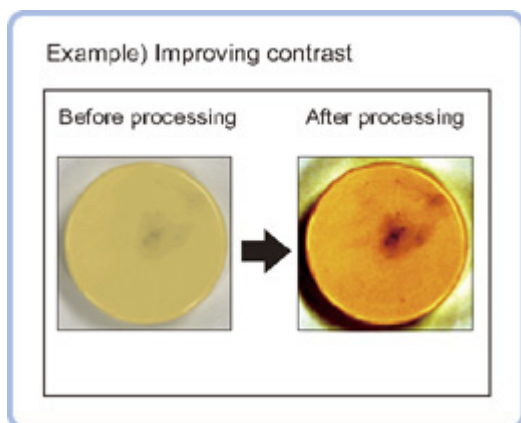

Basic concept of background suppression

Because input values from 0 to [Lower] are converted to level 0 and values from [Upper] to 255 are converted to level 255, the background in this range is eliminated.

Together with this, only [Lower] to [Upper] from the input values 0 to 255 are taken and those are converted to output values of 0 to 255, so the contrast within this range is emphasized.

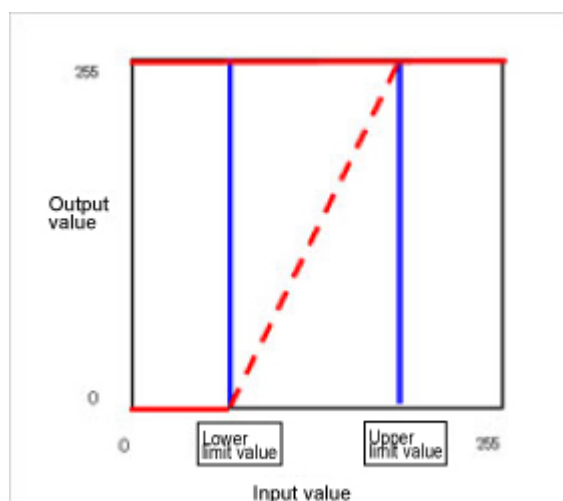

Filter Setting (Background Suppression)

This item sets the filter.

1. In the Item Tab area, tap [Filter Setting].

- In the "Display" area, tap [Change display] to switch between camera image types.

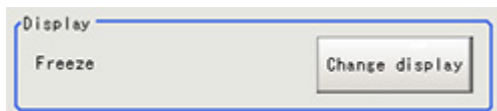

The displayed contents of the Image Display area will be switched.

Setting item	Set value [Factory default]	Description
Display	Through	The latest image is always input from the camera and displayed.
	[Freeze]	The image that was scanned in the immediately preceding measurement is displayed.

- Set the background suppression level.
There are two setting methods: specifying the section in the image whose contrast is to be emphasized or specifying the extraction range with numeric values.

For color cameras:

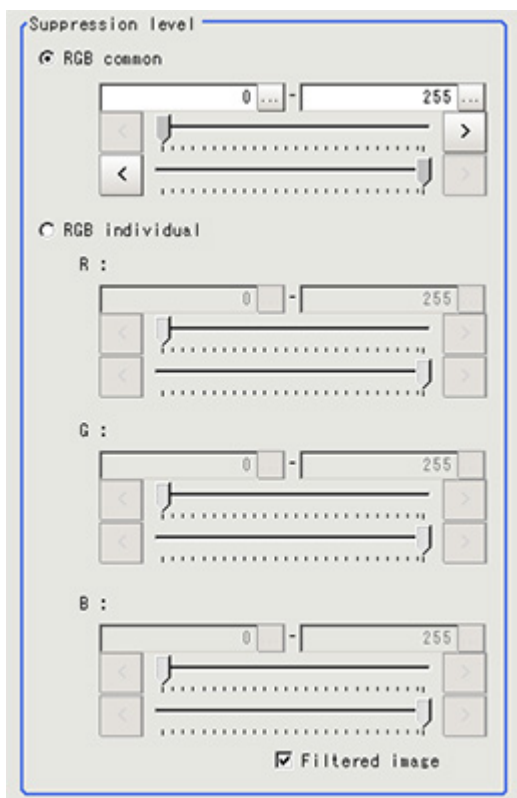

Item	Set value [Factory default]	Description
Suppression level	RGB common 0 to 255	The upper and lower limits for the background suppression level are set in common for RGB. The range from the set minimum to the set maximum is converted to 0 to 255.
	RGB individual 0 to 255	The maximum and minimum for the background suppression level are independently for RGB. The range from the set minimum to the set maximum is converted to 0 to 255.

For monochrome cameras:

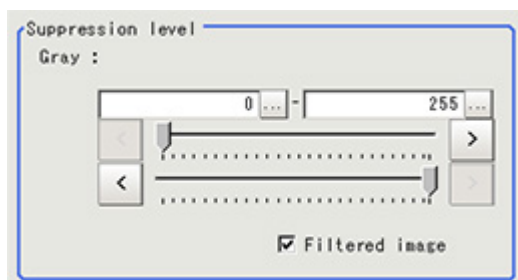

Setting item	Set value [Factory default]	Description
Gray	0 to 255	The set range is converted to 0 to 255.

4. As necessary, set the display image.



Region Setting (Background Suppression)

It is possible to target the entire screen, but restricting the range can shorten the processing time.

1. In the Item Tab area, tap [Region setting].
2. Use the Drawing tools to specify the measurement region.

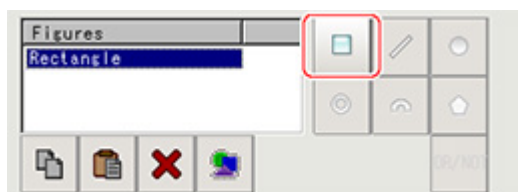

3. In the figure setting area, tap [OK].
The area in which to perform filtering is registered.

Measurement Results for Which Output Is Possible (Background Suppression)

The following values can be output using processing items related to results output. It is also possible to reference measurement values from expressions and other processing units.

Measurement items	Character string	Description
Judgement	JG	Judgement result

Color Gray Filter

This processing item converts a color image input from a color camera into a monochrome image. The available filters are "Primary color filter (RGB)", "Complementary color filter (CMY)", "Brightness filter", and "HSV filter."

This processing item cannot be used with monochrome images. Such use causes a judgement of NG (incompatible image).

Note

- The processing items after [Color Gray Filter] are the same as when a monochrome camera is connected.

Used in the Following Case

- To convert a color image to a monochrome image with a specific color enhanced

Example) To obtain a monochrome image with the dark red area enhanced

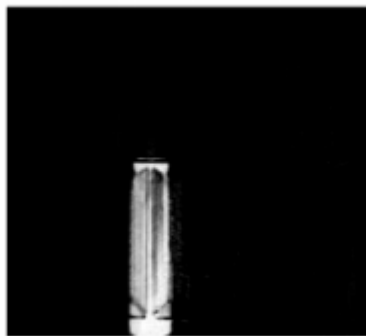

Filter Setting (Color Gray Filter)

This item sets the filter.

1. In the Item Tab area, tap [Filter Setting].
2. In the "Display mode" area, tap [Change display] to switch between camera image types.



The displayed contents of the Image Display area will be switched.

Setting item	Set value [Factory default]	Description
Display mode	Through image display	The latest image is always input from the camera and displayed.
	[Freeze image display]	The image that was scanned in the immediately preceding measurement is displayed.

3. Select the type of filter in the "Filter type" area.

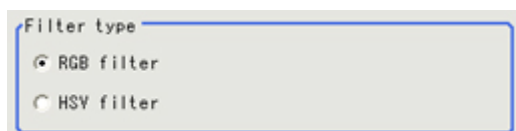

Setting item	Set value [Factory default]	Description
Filter kind	[RGB filter]	Specify the color extraction range with R, G, and B.
	HSV filter	Specify the color extraction range with hue and color chroma.

When RGB is selected

4. Select the type of color filter in the "RGB filter" area.
If "Custom filter" is selected, set the "Gain (Red)", "Gain (Green)", and "Gain (Blue)" as necessary.

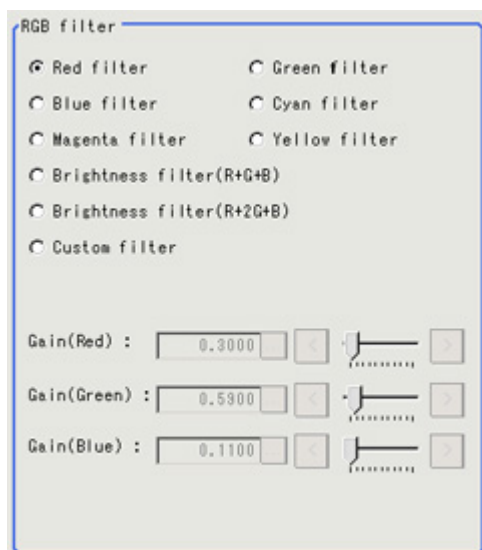

Setting item	Set value [Factory default]	Description
RGB Filter	<ul style="list-style-type: none"> • [Red filter] • Green filter • Blue filter • Cyan filter • Magenta filter • Yellow filter • Brightness filter(R+G+B) • Brightness filter(R+2G+B) • Custom filter • Minimum filter 	This item produces the same effects as using the selected optical filters.
Gain (Red)	0.0001 to 9.9999 [0.3]	RGB gain values when processing with a custom filter. The density of the color component increases as the value increases. This can be set only when "Custom filter" is selected for RGB filter.
Gain (Green)	0.0001 to 9.9999 [0.59]	
Gain (Blue)	0.0001 to 9.9999 [0.11]	

When you choose the HSV option

5. Select the type of filter in the "HSV filter" area.

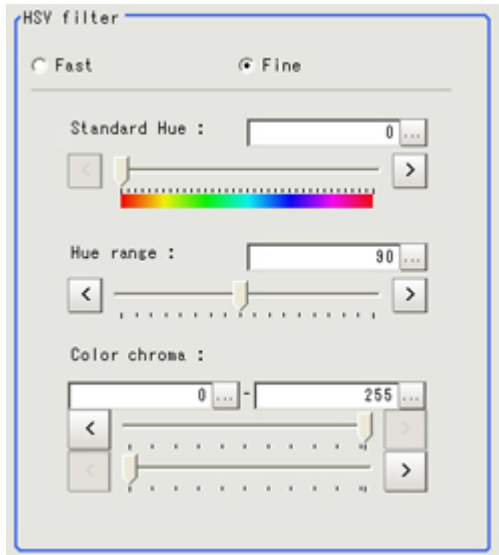

Setting item	Set value [Factory default]	Description
HSV filter	<ul style="list-style-type: none"> • Fast • [Fine] 	"Fast": The color extraction range is set only by hue. "Fine": Extraction is set by standard hue, hue range, and color chroma.
Standard Hue	[0] to 359	Specify the standard hue (tone) for the HSV filter. The density decreases as the difference in hue from the standard hue (difference in tone) increases.
Hue range	10 to 180 [90]	Specify the hue range (difference in tone) of the HSV filter. The hue difference is obtained by dividing the specified hue range into 255 subranges with the standard hue as the center subrange. The density of the hue outside the hue range is 0. This can only be set when "Fine" is selected.

Color chroma	[0] to [255]	Specify the upper and lower limits for saturation (vividness). This can only be set when "Fine" is selected.
-----------------	--------------	--

Extract Color Filter

The color image is extracted by color. Up to 8 ranges can be set. However, this processing item cannot be used with monochrome images.

Used in the Following Case

- To extract an object of different color.

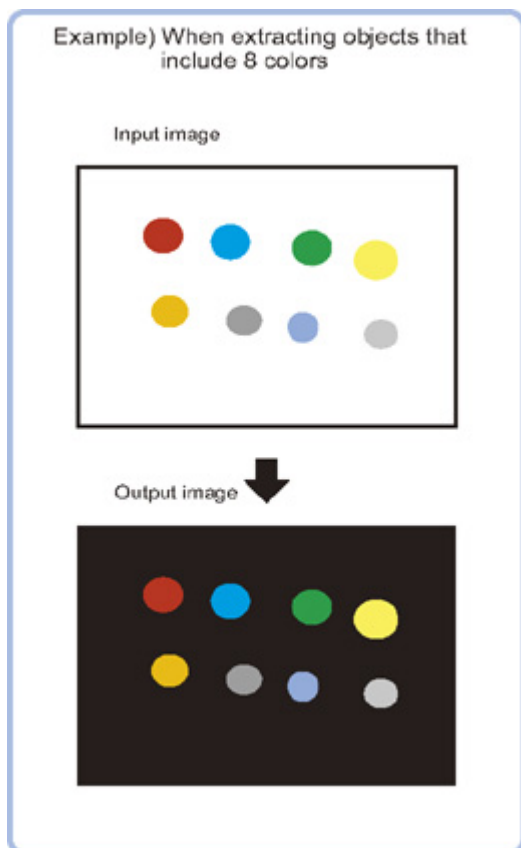

Color Specification (Extract Color Filter)

When connecting a color camera, specify the color to be measured. There are two specification methods: specifying the color to be extracted in the image or specifying the color with the hue, saturation, and brightness values.

This section describes how to specify colors in an image and gives an example of the procedure for finely adjusting with numeric input afterwards.

1. In the Item Tab area, tap [Color setting].
2. Place a check at [Auto setting].
3. In the Image Display area, specify the color range you want to detect by dragging the cursor from the upper left corner to the lower right corner of that area.
The color of the specified area is automatically set.

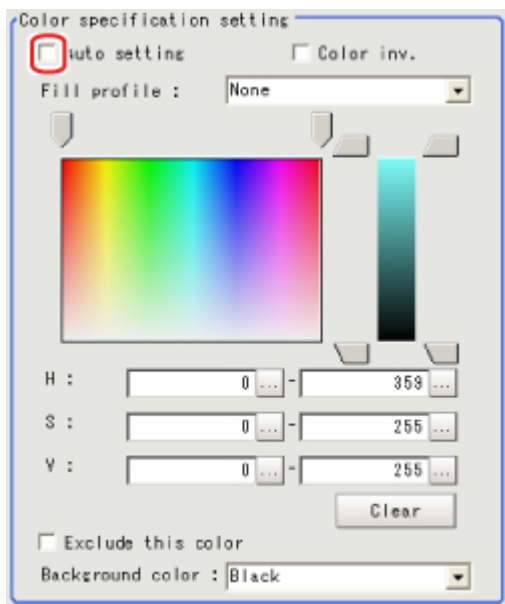

4. As necessary, select Fill profile.

Item	Set value [Factory default]	Description
	[None]	The empty section in the center is not filled in.
Fill profile	Fill profile	<p>In the measurement region, the part between the extracted-color start point and end point in the X-axis direction is measured as having the extracted color. Since filling is applied only to the X-axis direction, the processing is faster than filling up holes.</p> <p style="text-align: center;">Input image Fill profile image</p>
	Filling up holes	<p>The part surrounded by the extracted color, like a doughnut hole, is filled with the extracted color.</p> <p style="text-align: center;">Input image Image after filling up hole</p>

5. Finely adjust the hue, saturation, and brightness if necessary.
Adjust either by adjusting on the color chart or by inputting numbers.

Item	Set value [Factory default]	Description
H	0 to 359	Specify the color phase (difference of color hues).
S	0 to 255	Specify color saturation (difference of color saturation).

V	0 to 255	Specify the brightness (difference of brightness).
Auto setting	<ul style="list-style-type: none"> • Checked • [Unchecked] 	Specifying the color to be measured on the image automatically sets the hue, saturation, and brightness.
Color inv.	<ul style="list-style-type: none"> • Checked • [Unchecked] 	Everything other than the specified color becomes the measurement target.

About color charts

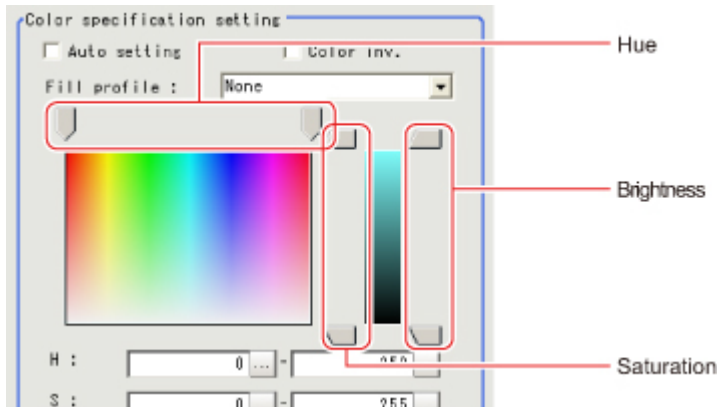

6. To specify multiple colors, place a check at "More ranges of color extraction".

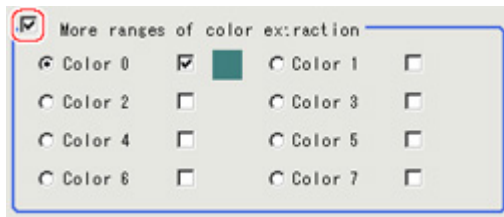

Setting item	Set value [Factory default]	Description
More ranges of color extraction	<ul style="list-style-type: none"> • Checked • [Unchecked] 	If you place a check at this option, you can set up to 8 colors.

7. If necessary, set the display conditions for displayed images.

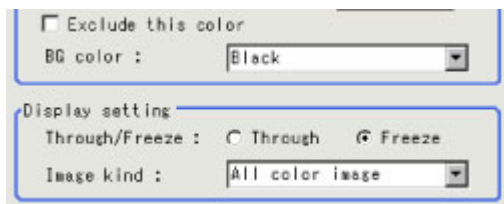

Setting item	Set value [Factory default]	Description
Exclude this color	<ul style="list-style-type: none"> • Checked • [Unchecked] 	If you place a check at this option, pixels within the HSV range are excluded from color extraction. The priority order for exclusion is that the higher color extraction range numbers are given priority. This setting is disabled if "More ranges of color extraction" is unchecked.

Background color	<ul style="list-style-type: none"> • [Black] • White • Red • Green • Blue 	<p>The background section outside the extracted image is filled with the specified colors.</p> <p>The background colors that can be set depend on the display settings.</p> <p>When "Color selected image" is selected, the background color can be set for each selected color. When All color image is selected, the background color for color extraction range 0 is used.</p>
Through/ Freeze	<ul style="list-style-type: none"> • Through • [Freeze] 	<p>For Through, the latest image from the camera is always displayed; for Freeze, the image that was scanned in the immediately preceding measurement is displayed.</p>
Type of image	<ul style="list-style-type: none"> • Measurement image • [All color image] • Color selected image • Binary image 	<p>This sets the state of the image to display.</p>

Region Setting (Extract Color Filter)

Use a rectangle to specify the area where the model is searched. Instead of measuring the entire input image, narrowing the measurement area shortens the processing time.

1. In the Item Tab area, tap [Region setting].
2. Tap [Edit].

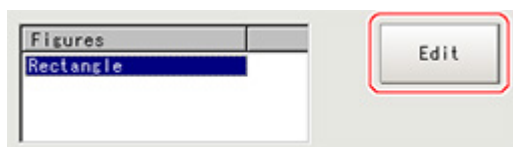

The figure setting area is displayed.

3. Specify the area in which to search for the model.
The rectangle covering the entire screen is set. Adjust the size and position of the rectangle.
4. Tap [OK].
The area to measure is registered.

Output Image (Extract Color Filter)

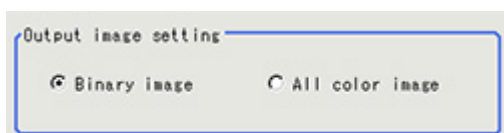

Setting item	Set value [Factory default]	Description
Output image setting	<ul style="list-style-type: none"> • [Binary image] • All color image 	This sets the state of the image output.

Measurement Results for Which Output Is Possible (Extract Color Filter)

The following values can be output using processing items related to results output. It is also possible to reference measurement values from expressions and other processing units.

Measurement items	Character string	Description
Judgement	JG	Judgement result



Anti Color Shading

This filter eliminates color unevenness in the image. Unevenness is eliminated either by converting the two specified colors toward the color midway between them or by converting one of the two specified colors to approach the other. However, this processing item cannot be used with monochrome images.

Used in the Following Case

- This is used when a work that would be expected to have uniform color has a non-uniform image due to the effect of tilting, uneven paint, or the like.

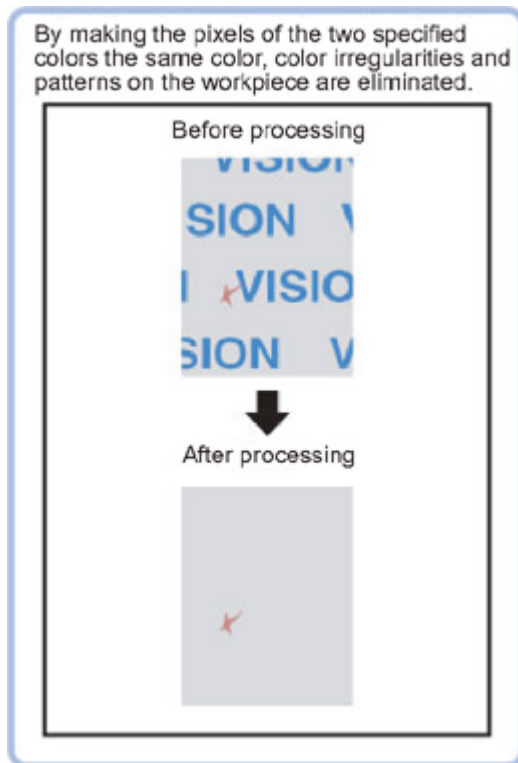

Filter Setting (Anti Color Shading)

This item sets the filter.

- In the Item Tab area, tap [Filter setting].
- In the "Display" area, tap [Change display] to switch between camera image types.



The displayed contents of the Image Display area will be switched.

Setting item	Set value [Factory default]	Description
Display	Through image display	The latest image is always input from the camera and displayed.
	[Freeze image display]	The image that was scanned in the immediately preceding measurement is displayed.

- The section with color contrast on the image is enclosed.
The image with the contrast suppressed is displayed.



- Adjust the color, conversion direction, and Anti Color Shading level as necessary.
The picked up 2 colors are displayed at Color 1 and Color 2.
Fine adjustments can also be made to the R, G, and B values and on the color chart.

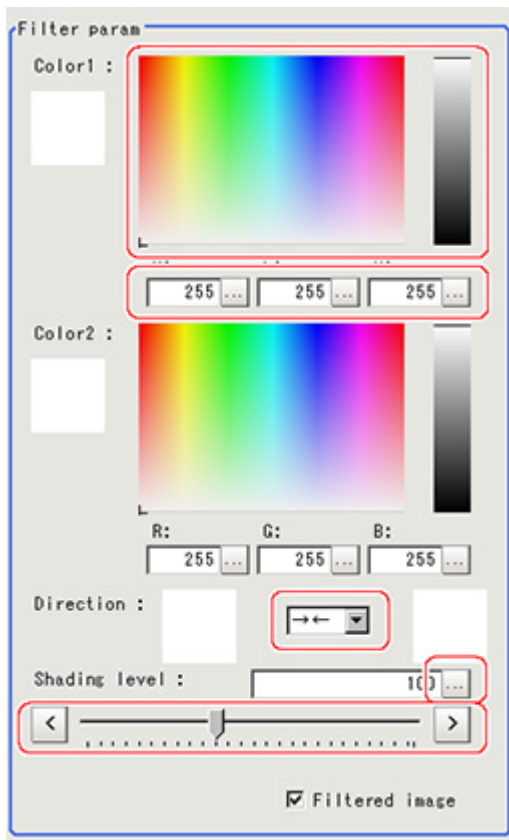

Setting item	Set value [Factory default]	Description
Color 1	<ul style="list-style-type: none"> • R 0 to [255] • G 0 to [255] • B 0 to [255] 	The most separate two colors are picked up from the specified region. The sections corresponding to these colors in the region are converted to the color midway between the two.
Color 2	<ul style="list-style-type: none"> • R 0 to [255] • G 0 to [255] • B 0 to [255] 	

Direction	<ul style="list-style-type: none"> · [→ ←] · → · ← 	Select the conversion method for the set Color 1 and Color 2. →← :Color 1 and Color 2 are converted to the color midway between the two. → :Color 1 is converted to Color 2. ← :Color 2 is converted to Color 1.
Shading level	0 to 255 [100]	Set the level for suppressing color contrast. The larger this value, the less the color contrast.

5. As necessary, set the display image.

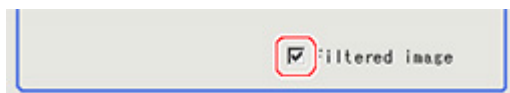

Setting item	Set value [Factory default]	Description
Filtered image	<ul style="list-style-type: none"> · [Checked] · Unchecked 	To display the original image, uncheck here.

Region Setting (Anti Color Shading)

It is possible to target the entire screen, but restricting the range can shorten the processing time.

1. In the Item Tab area, tap [Region setting].
2. Use the Drawing tools to specify the measurement region.

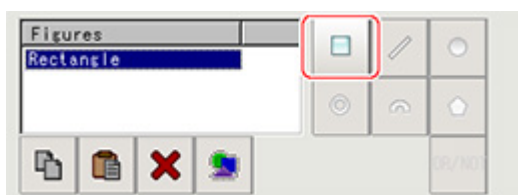

3. In the figure setting area, tap [OK].
The area in which to perform filtering is registered.

Key Points for Test Measurement and Adjustment (Anti Color Shading)

The following content is displayed in the "Detail result" area as text.

Displayed items	Description
Judge	Judgement result

Measurement Results for Which Output Is Possible (Anti Color Shading)

The following values can be output using processing items related to results output. It is also possible to reference measurement values from expressions and other processing units.

Measurement items	Character string	Description
Judgement	JG	Judgement result

Stripes Removal Filter+

This is a processing item for just FZ3-H □□□ series high grade controllers. Eliminating a striped pattern or other background makes it possible to stably extract just the defect without it being affected by the background.

Used in the Following Case

- To eliminate vertical stripes, horizontal stripes, or a grid of stripes from the target.

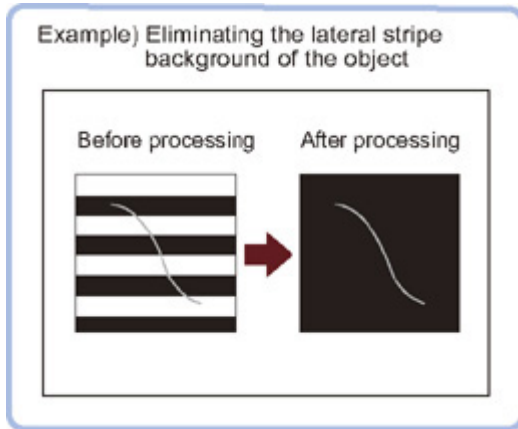

Important

- When FZ3-H□□□ series dedicated processing items are used, processing is carried out that reduces the processing time from the second time on. Therefore, when measuring the same image, the processing for the first time after the controller is started up may be longer than the processing time from the second time on.
- This processing item is for monochrome only. When using a color camera, insert a color gray filter before this processing item. If a color image is input, it is NG (incompatible image).

Filter Setting (Stripes Removal Filter+)

This item sets the filter.

- In the Item Tab area, tap [Filter Setting].
- In the "Display mode" area, tap [Change display] to switch between camera image types.

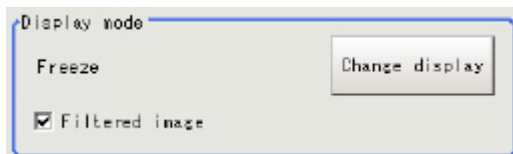

The displayed contents of the Image Display area will be switched.

Setting item	Set value [Factory default]	Description
Display mode	Through	The latest image is always input from the camera and displayed.
	[Freeze]	The image that was scanned in the immediately preceding measurement is displayed.

3. Set the target image.

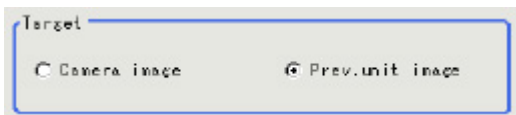

Setting item	Set value [Factory default]	Description
Target	Camera image	The camera input image that has not been subject to filtering is subject to compensation as is.
	[Prev. unit image]	Images to which processing is applied in units even before the "Stripes Removal Filter+" being set are the targets.

4. This sets the filter settings.

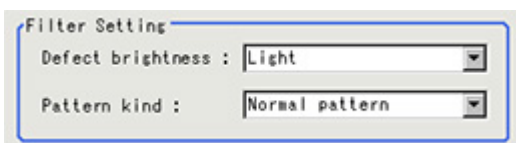

Setting item	Set value [Factory default]	Description
Defect brightness	<ul style="list-style-type: none"> [Light] Darkness Light and darkness 	Set the brightness of defects to be extracted from the background. To detect both white defects and black defects, select "Light and darkness".
Pattern kind	<ul style="list-style-type: none"> [Normal pattern] Vertical stripes Horizontal stripes Cross stripes 	Select the pattern design to be eliminated as background. Normal: Used to eliminate patterns without the specified pattern. The pattern eliminated must be adequately larger than the defect to be extracted. Vertical stripe: Vertical stripe patterns are eliminated. Horizontal stripe: Horizontal stripe patterns are eliminated. Grid: Grid patterns are eliminated

5. Set the details.

Pattern kind: "Normal pattern", "Vertical stripes", or "Horizontal stripes"

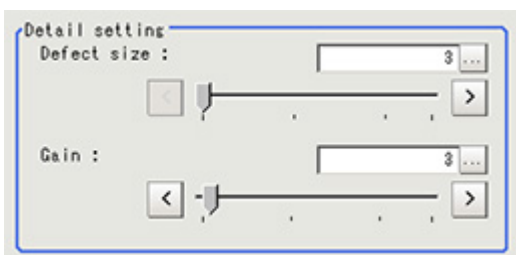

Setting item	Set value [Factory default]	Description
Defect size	3 to 63 [3]	Specify a larger value to match the size of the defects to be extracted.
Gain	1 to 63 [3]	Adjust the contrast of an image after the pattern suppression. Specifying a larger value emphasizes the density differences within the image.

Pattern kind: "Cross stripes"

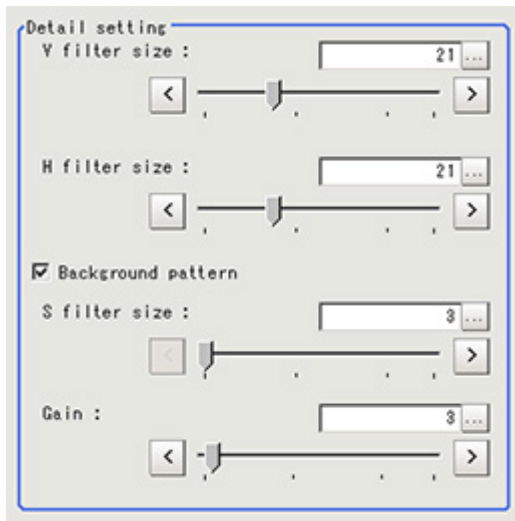

Setting item	Set value [Factory default]	Description
V filter size	3 to 63 [21]	Set the grid pattern vertical direction width. Only for "Pattern kind" of grid
H filter size	3 to 63 [21]	Set the grid pattern horizontal direction width. Only for "Pattern kind" of grid
Background pattern	<ul style="list-style-type: none"> · [Checked] · Unchecked 	Place a check here if there is yet another pattern to eliminate within the grid pattern. Only for "Pattern kind" of grid
S filter size	3 to 63 [3]	Match this size to the size of the pattern you want to eliminate from within the grid pattern.
Gain	1 to 63 [3]	Adjust the contrast of an image after the pattern suppression. Specifying a larger value emphasizes the density differences within the image.

Region Setting (Stripes Removal Filter+)

It is possible to target the entire screen, but restricting the range can shorten the processing time.

1. In the Item Tab area, tap [Region setting].
2. Use the Drawing tools to specify the measurement region.

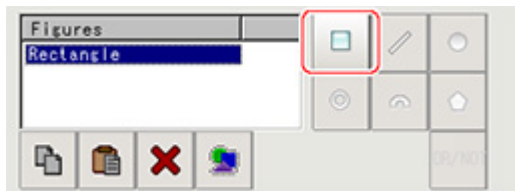

3. In the figure setting area, tap [OK].
The area in which to perform filtering is registered.

Halation Cut+

This is a processing item for just FZ3-H □□□ series high grade controllers.

Using the characteristic that halation occurs if the lighting causes reflection within the camera, just the wavelength of mirror reflected light is suppressed to eliminate halation

When a color image is shot with red and blue lighting used together, this converts the image into a monochrome image with the red or blue mirror reflected light removed.

Used in the Following Case

- To create a monochrome image with halation removed

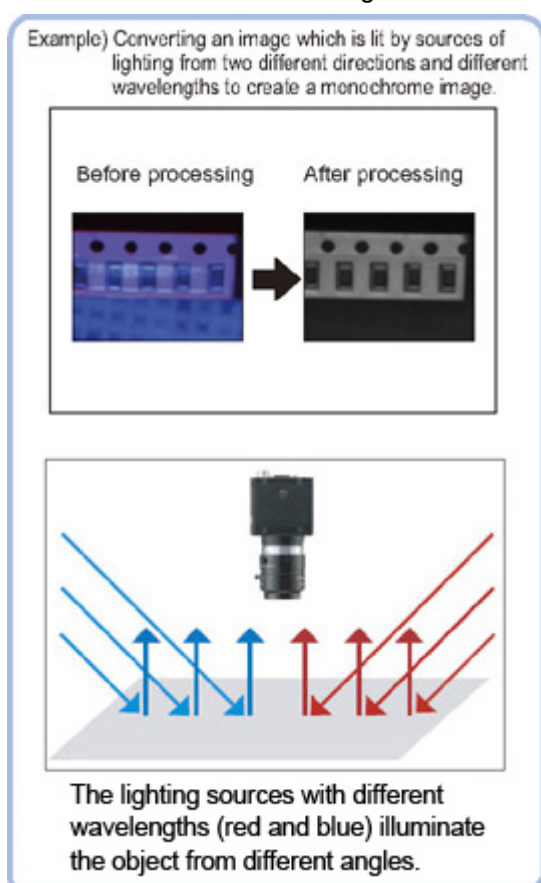

Important

- When FZ3-H□□□ series dedicated processing items are used, processing is carried out that reduces the processing time from the second time on. Therefore, when measuring the same image, the processing for the first time after the controller is started up may be longer than the processing time from the second time on.
- Install the red and blue lighting separated by at least 90 degrees (as seen from the workpiece). If the red and blue lighting are positioned too close to each other, the halation suppression effect cannot be obtained.

Filter Setting (Halation Cut+)

This item sets the filter.

1. In the Item Tab area, tap [Filter Setting].

2. In the "Display" area, tap [Change display] to switch between camera image types.



The displayed contents of the Image Display area will be switched.

Setting item	Set value [Factory default]	Description
Display	Through image display	The latest image is always input from the camera and displayed.
	[Freeze image display]	The image that was scanned in the immediately preceding measurement is displayed.

3. Set each item in the "Filter parameter" area.

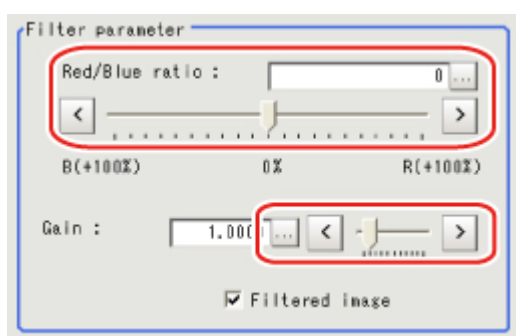

Setting item	Set value [Factory default]	Description
RGB ratio	-100 to 100 [0]	Adjust the balance of the red brightness and blue brightness for the shot image. Specifying a larger value in the positive direction (R direction) makes the R component easier to suppress. Specifying a larger value in the negative direction (B direction) makes the B component easier to suppress.
Gain	0.0001 to 9.9999 [1.0000]	Adjust the gain for compensating the brightness of the output image.

4. As necessary, check the image after conversion.



Setting item	Set value [Factory default]	Description
Filtered image	<ul style="list-style-type: none"> • [Checked] • Unchecked 	To display the original image, uncheck here.

Measurement Results for Which Output Is Possible (Halation Cut+)

The following values can be output using processing items related to results output. It is also possible to reference measurement values from expressions and other processing units.

Measurement items	Character string	Description
Judgement	JG	Judgement result

Panorama+

This is a processing item for just FZ3-H □□□ series advanced-function controllers. Images from multiple cameras are combined into one image. 5 megapixel camera or intelligent compact camera, FZ-SQ □ □ □ □ cannot be used. With panorama+, only camera images of the same type can be input.

Used in the following case

- To combine the input images from multiple cameras

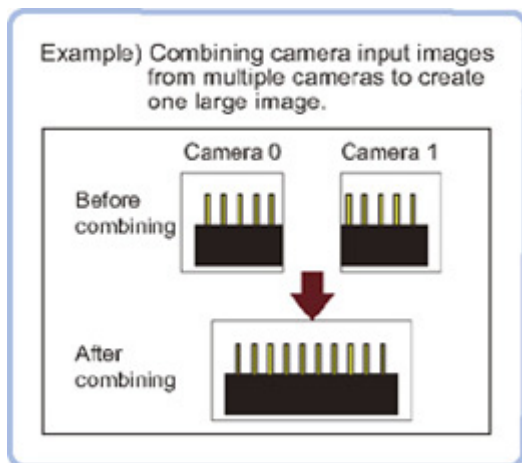

Important

- If dedicated processing items for the FZ3-H □□□ series are used, a process to reduce the processing time for the second and subsequent processing is implemented. Accordingly, the first processing after the controller is started may take longer than the second and subsequent processing even though the same image is measured.
- An image after panorama conversion cannot be saved. Re-measure the image saved with image logging, and then check on the controller.

Camera Placement and Image Combination Method

Place the cameras so that the field of vision of each camera overlaps at least 1/4. To place cameras and combine the images, we recommend using the following setting images.

• Two line Arrangement Image

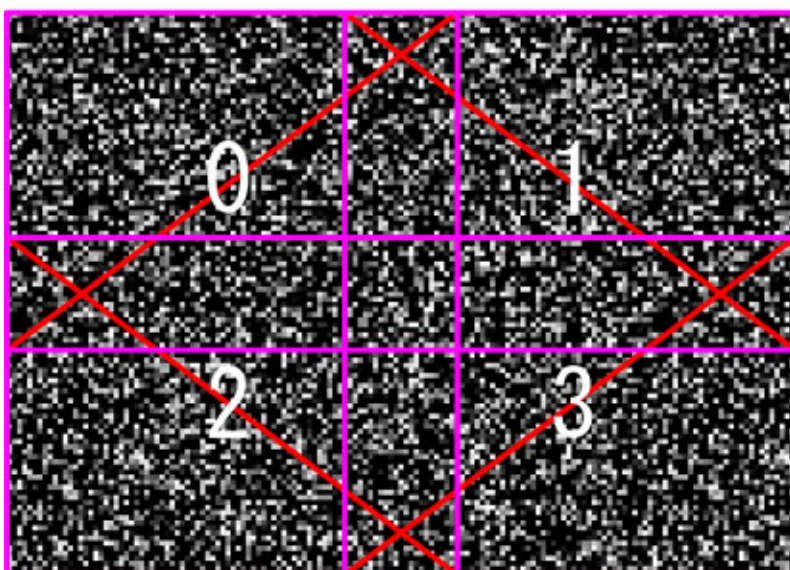

• One line Arrangement Image

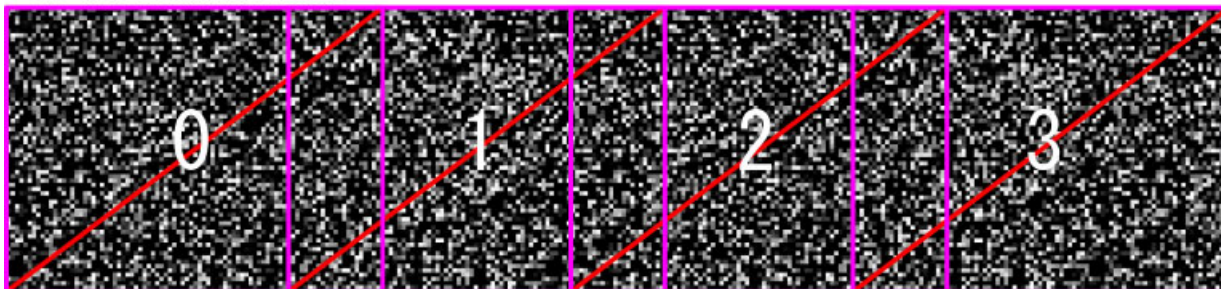

For 2 x 2 camera placement

1. Set the camera placement.

Adjust the camera placement so that the fields of vision overlap at least 1/4 for cameras 0 and 1, 1 and 2, and 2 and 3.

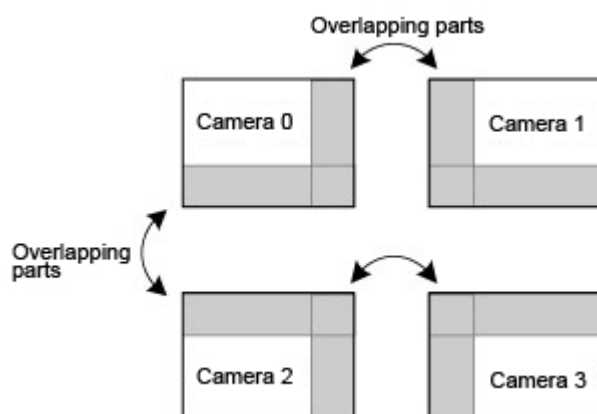

2. Set the image combination method.

Use the Offset X, Y buttons in the software to adjust so that the overlapping sections of neighboring images match.

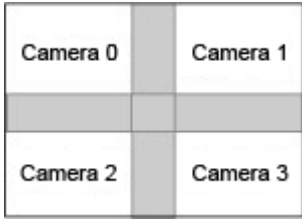

3. Combine the image.
Tap the Combine button in the software.

For 1 x 4 camera placement

1. Set the camera placement.
Adjust the camera placement so that the fields of vision overlap at least 1/4 for cameras 0 and 1, 1 and 2, and 2 and 3.

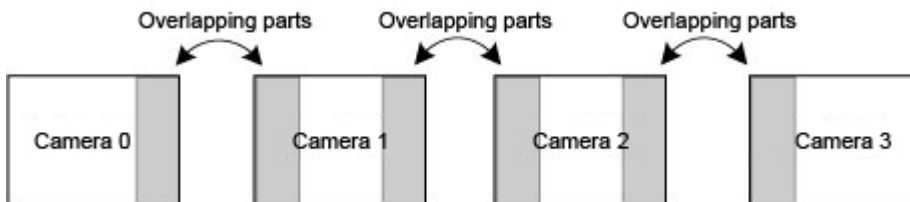

2. Set the image combination method.
Use the Offset X, Y buttons in the software to adjust so that the overlapping sections of neighboring images match.

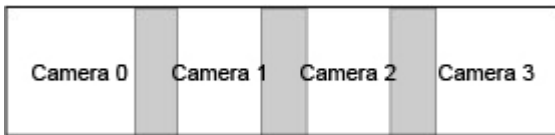

3. Combine the image.
Tap the Combine button in the software.

Camera Placement (Panorama+)

Set the camera placement.

1. In the Item Tab area, tap [Arrangement].
2. In the "Display" area, tap [Change display] to switch between camera image types.

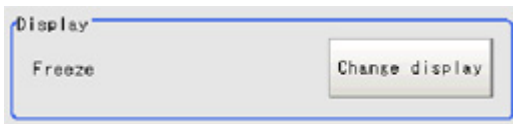

The displayed contents of the Image Display area will be switched.

Setting item	Set value [Factory default]	Description
Display	Through	The latest image is always input from the camera and displayed.
	[Freeze]	The image that was scanned in the immediately preceding measurement is displayed.

3. Set the camera settings.



Setting item	Set value [Factory default]	Description
Camera select	<ul style="list-style-type: none"> • [0+1] • 0+1+2 • 0+1+2+3 	Select the combination of cameras to combine the images from. 0+1: Combine the images from Camera0 and Camera1. 0+1+2: Combine the images from Camera0, Camera1, and Camera2. 0+1+2+3: Combine the images from Camera0, Camera1, Camera2, and Camera3.

4. Set the camera placement.

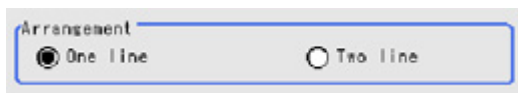

Setting item	Set value [Factory default]	Description
Arrangement	<ul style="list-style-type: none"> • [One line] • Two line 	Set the camera image placement. <div style="display: flex; flex-direction: column; align-items: center;"> <div style="text-align: center;"> <p>(1 x 4) Camera placement</p> </div> <div style="text-align: center; margin-top: 20px;"> <p>(2 x 2) Camera placement</p> </div> </div>

Important

- If the configuration of the connected camera is changed, the measurement result is NG (incompatible image). Press the initialize button and re-do the settings.
- Do not set [Camera Image Input] or [Camera Image Input HDR] after [Panorama+].

Image Combination (Panorama+)

Set the image combination method.

1. In the Item Tab area, tap [Combine].
2. Set each item in the "Position" area.

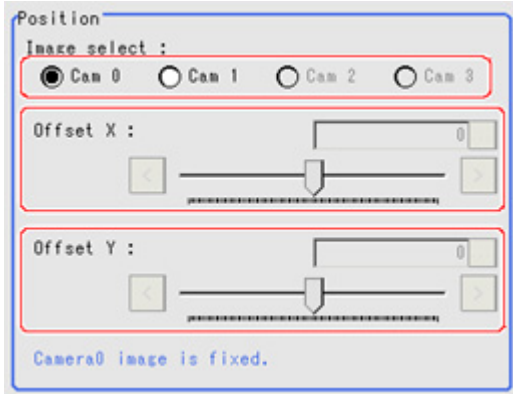

Setting item	Set value [Factory default]	Description
Image select	<ul style="list-style-type: none"> • [Cam 0] • Cam 1 • Cam 2 • Cam 3 	Select the camera image for adjusting the combination position. Camera 0 is fixed. Adjust the combination position to the position where you want to add in Camera1 and higher.
Offset X	For 0.3 megapixel cameras: -640 to 640 [0] For 2 megapixel cameras: -1600 to 1600 [0]	Adjust the selected camera image in the X direction.
Offset Y	For 0.3 megapixel cameras: -480 to 480 [0] For 2 megapixel cameras: -1200 to 1200 [0]	Adjust the selected camera image in the Y direction.

3. In the "Combine setting" area, set the combination method.



Setting item	Description
Combine	This option combines images panoramically so that the detected feature points (same location on the object as positioned differently on the different images) line up with each other in the combined image.

4. Set details as necessary.

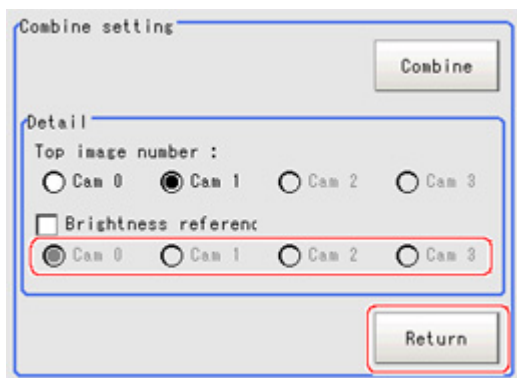

Setting item	Set value [Factory default]	Description
Top image number	<ul style="list-style-type: none"> • [Cam 0] • Cam 1 • Cam 2 • Cam 3 	Select the number of the camera image to be displayed on top. The selected number order changes the order of the images.
Brightness reference	<ul style="list-style-type: none"> • Checked • [Unchecked] 	Place a check here where there is brightness variation among the camera images.
	<ul style="list-style-type: none"> • [Cam 0] • Cam 1 • Cam 2 • Cam 3 	Set the number of the camera to be used as reference for brightness compensation. The brightness of the selected camera image is used as reference to adjust the brightness of the other cameras.

Restoring settings to their initial states

Tapping [Initialize] restores settings to their initial states.

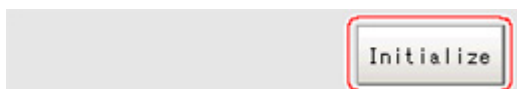

5. Make the drawing settings as necessary.

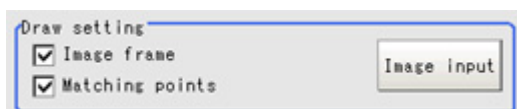

Setting item	Set value [Factory default]	Description
Image frame	<ul style="list-style-type: none"> • [Checked] • Unchecked 	Set whether to display the image frame.
Matching points	<ul style="list-style-type: none"> • [Checked] • Unchecked 	Set whether to display feature points.

Measurement Results for Which Output Is Possible (Panorama+)

The following values can be output using processing items related to results output. It is also possible to reference measurement values from expressions and other processing units.

Measurement items	Character string	Description
Judgement	JG	Judgement result

Polar Transformation

Wide circle and fan shape images are transformed in polar coordinates and converted into orthogonal coordinate images. The converted image is a measurement object for processing units in later stages.

Used in the Following Case

- This is used for judging characters printed around the circumference of caps and the like.

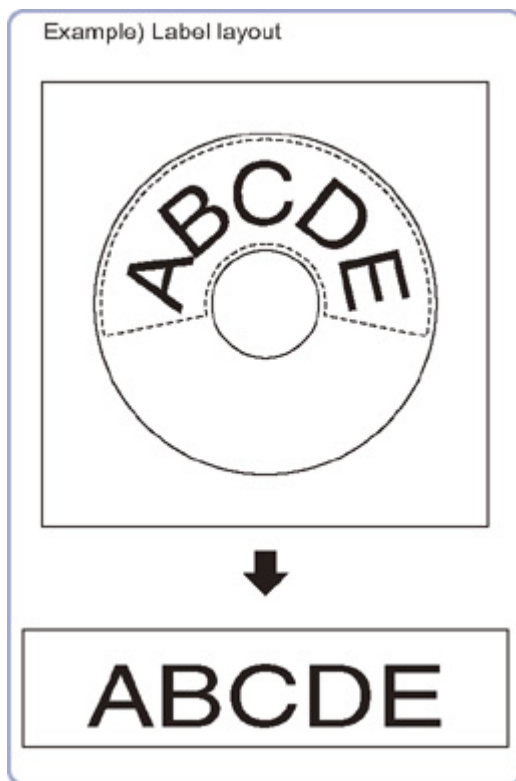

Important

- When using polar transformation and a position list, display with [Polar Transformation].
If the image is displayed with [Camera Image Input] or the like before the [Polar Transformation], the graphic is not displayed correctly.

Region Setting (Polar Transformation)

Set a region enclosing the character string that is lined up along a circle.

1. Use the Drawing tools to specify the measurement region.

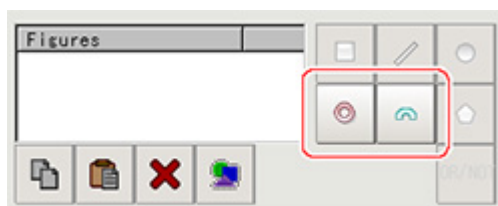

- Enclose the characters in the image.



- In the figure setting area, tap [OK].
The measurement region is registered and displayed in the Image Display area.
- As necessary, set the items in the "Circle setting" area.

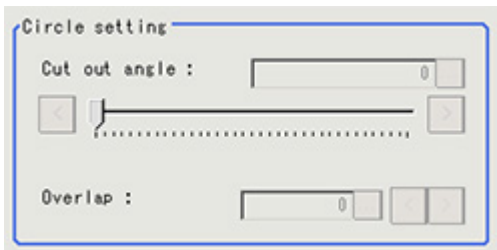

Setting item	Set value [Factory default]	Description
Cut out angle	[0] to 359	Set the angle for starting extraction when the figure is a wide circle.
Overlap	[0] to 180	Set the angle for overlap when the figure is a wide circle. The overlap angle indicates the end angle of the measurement range. This is set to measure extra overlapping from the start angle. Basically, set this larger than the extraction angle.

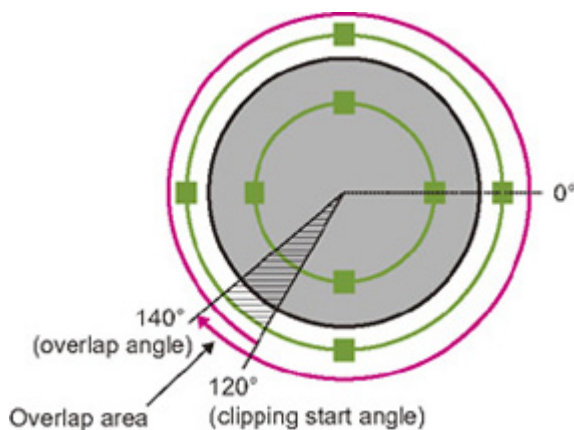

- Place a check at [Disp transferred image].
Displays the polar transformed image in the image window.
The vertical and horizontal image sizes (in pixels) are displayed overlapped.

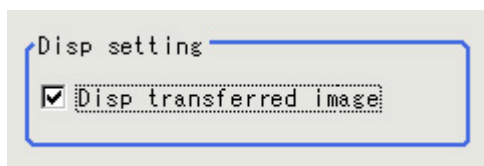



Measurement Results for Which Output Is Possible (Polar Transformation)

The following values can be output using processing items related to results output. It is also possible to reference measurement values from expressions and other processing units.

Measurement items	Character string	Description
Judgement	JG	Judgement result



Support Inspection and Measurement

This chapter explains how to set calculations and how to get or view data.

- ▶ Reference: Calculation (p.340)
- ▶ Reference: Line Regression (p.351)
- ▶ Reference: Circle Regression (p.356)
- ▶ Reference: Calibration+ (p.359)
- ▶ Reference: Set Unit Data (p.364)
- ▶ Reference: Get Unit Data (p.366)
- ▶ Reference: Set Unit Figure (p.368)
- ▶ Reference: Get Unit Figure (p.373)
- ▶ Reference: Trend Monitor (p.376)
- ▶ Reference: Image Logging (p.388)
- ▶ Reference: Data Logging (p.391)
- ▶ Reference: Elapsed Time (p.396)
- ▶ Reference: Wait (p.398)
- ▶ Reference: Focus (p.399)
- ▶ Reference: Iris (p.402)

Calculation

Used in the Following Case

- When changing the inspection details through use of calculation results

Example) Calculating the width of the measurement object
Width calculation can be performed by first calculating two edge positions and setting up the arithmetic expression which is used to calculate the edge position difference.

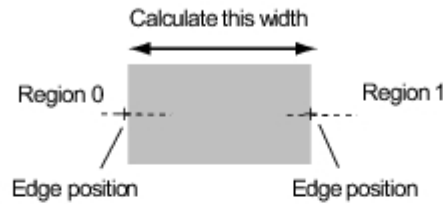

Width = the edge position of Area 0 - the edge position of Area 1

By combining Calculation and Conditional Branch, the following measurement contents can be changed based on the operational result.

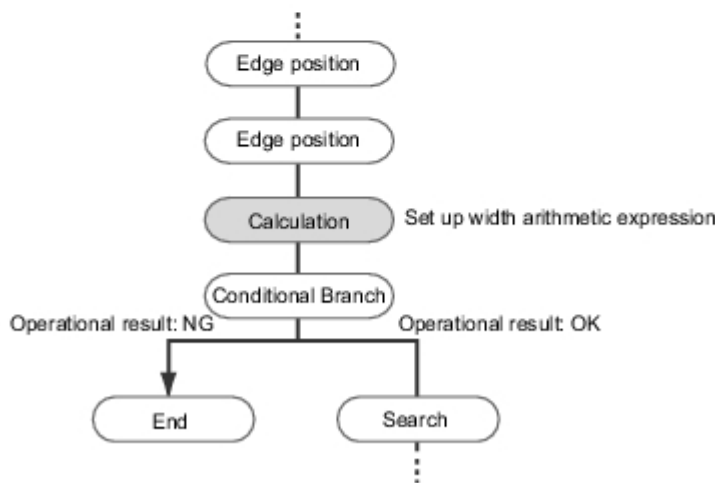

- When performing calculation by using the calculation results of other processing units.

Settings (Calculation)

Up to 8 expressions "Calculation 0" to "Calculation 7" can be set up in one single unit.

Note

- Calculation results cannot be output to external devices when you only set up expressions. When calculation results are output to external devices, set processing items related to results output in units after "Expression" with flow editing. Reference: ▶ Output result (p.419)

- In the Item Tab area, tap [Setting].
- Tap the "No." for setting up the expression from the list in the "Expression setting" area

The number selected will be displayed below the list.

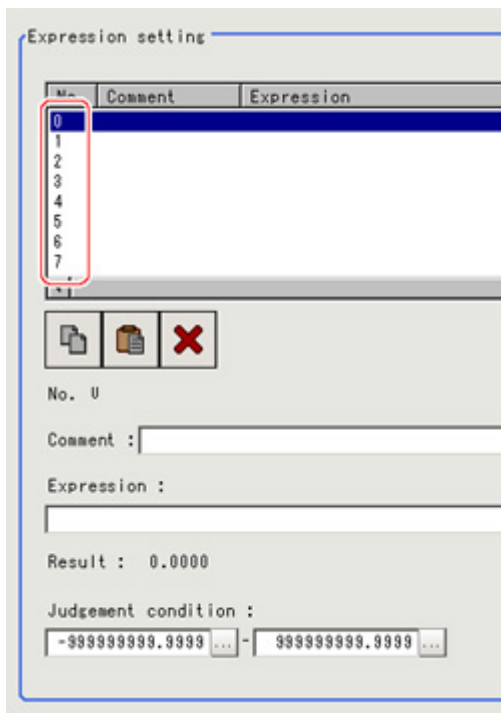

3. Tap [...] for the Expression.

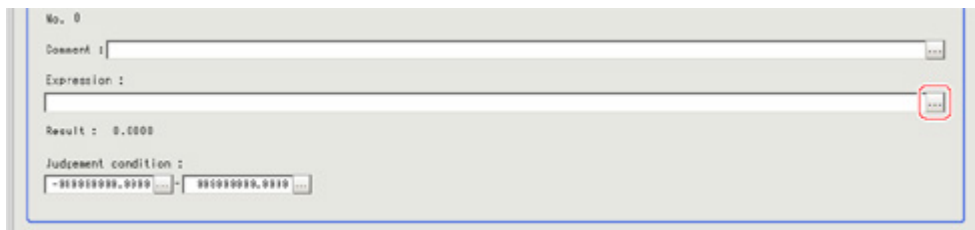

The Setting Expression window is displayed.

4. Set up the expression.
Sub-menus that can be set in expressions depending on the processing unit are displayed. When the sub-menu is tapped, it is added to the Expression.

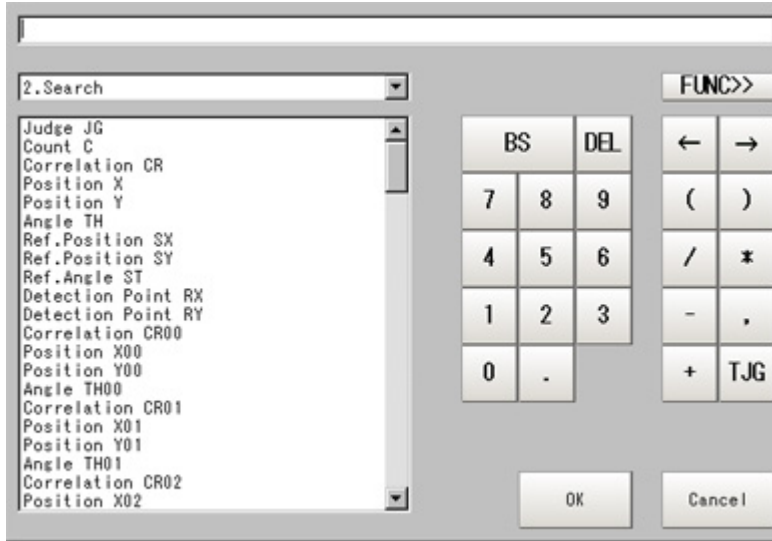

Reference: ▶ Layout of Setting Expression Window (p.343)

5. After setting up the expression, tap [OK].

The expression is confirmed.

Note

If an error message is displayed, please check the following points.

- Unit value, numbers, function or TJK settings should be just before or just behind operator.
- Operators and commas "," should not be placed at the start or end of an expression.
- Operators cannot be input continuously.
- TJK/Unit value/Functions cannot be input continuously.
- The left and right parentheses "(") should be used together.
- Please ensure that the function argument is set.

6. Tap [...] for "Comment" and input an explanation of the expression as necessary.
7. Set up the judgement upper limit and the judgement lower limit for "Judgement condition".

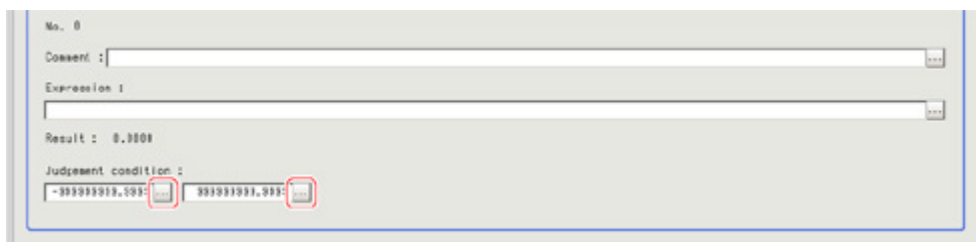

Setting item	Set value	Description
Judgement condition	-99999999.9999 to 99999999.9999	This is a judgement condition for the expression. Set upper and lower limits for judging as OK.

8. Repeat the Steps Reference: ▶ 2 (p.340) to Reference: ▶ 7 (p.342) and set up the expression.

Output Parameters (Calculation)

Specifies whether or not the judgement results of this processing unit is reflected in the scene overall judgement.

1. Tap [Output parameter] in the Item Tab area.
2. Choose whether or not to reflect this in the scene overall judgement in "Reflect to overall judgement" area.



Setting item	Set value [Factory default]	Description
Reflect to overall judgement	<ul style="list-style-type: none"> • [ON] • OFF 	Enables choosing whether or not the judgement results of this processing unit is reflected in the scene overall judgement.

Layout of Setting Expression Window

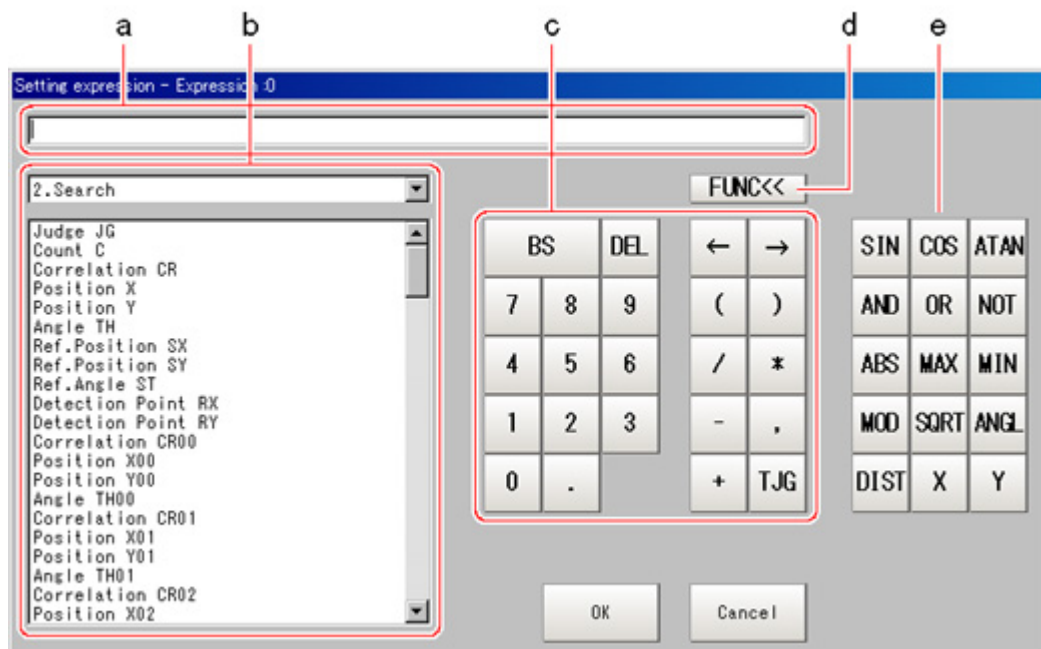

a. Expression Display Area

This area is for setting expressions. The expressions are displayed in the following manner.

[Function] [Unit No] [Submenu of Arithmetic Expression]
DIST (U1.X, U1.Y, U2.X, U2.Y)

[Unit No] [Operator] [Numeric value]
U2.D00 - 120.25

[Unit No] [Operator] [Submenu of Expression]
U0.JG + U1.JG

b. Unit Area

This area is where processing item values set in unit are selected. Tapping [▼] displays the unit number and unit name that have been set up in the currently displayed scene. Select the unit and then select items from sub-menus displayed for use in calculation.

Reference: Each processing item "Measurement Results for Which Output Is Possible"

c. General Button Area

These common buttons are required for editing expressions. Numbers and operators can be input here.

Button	Type	Description
BS	-	Deletes the item directly in the front of the cursor in the expression display area.
DEL	-	Deletes the item directly behind the cursor in the expression display area.
0 to 9	Numerical number	Numbers will be displayed at the cursor position in the expression display area. The number range that can be set up is from -999999999.9999 to 999999999.9999.
.	Symbol	A dot "." will be displayed at the cursor position in the expression display area.
←	Movement	The cursor in the expression display area moves one space to the left.
→	Movement	The cursor in the expression display area moves one space to the right.
(Symbol	Used to set off the numerical expression. Used in pairs with ")".
)	Symbol	Used to set off the numerical expression. Used in pairs with "(".
/	Operator	Indicates division for real numbers.
*	Operator	Indicates multiplication.
-	Operator	Indicates subtraction.
,	Symbol	A comma "," will be displayed at the cursor position in the expression display area.
+	Operator	Indicates addition.
TJG	-	Acquires the overall judgement result for all units ahead of the unit number in which an expression has been set. Reference: ▶ Conditional Branching Settings Examples (p.410)

d. [FUNC]

Display/Hide the function button area.

e. Function Button Area

Buttons for inputting functions.

Function	Description
SIN (equation)	Calculates the sine. The result will be returned within the range of -1 to 1. Indicates the angle designated in the numerical expression in degrees.
COS (equation)	Calculates the cosine. The result will be returned within the range of -1 to 1. Indicates the angle designated in the numerical expression in degrees.
ATAN (Y-axis component, X-axis component)	Calculates the arc tangent of the Y-axis component/X-axis component. The result will be returned in radians within the range of $-\pi$ and π . (Example) For calculation of the angle between the straight line that connects the centers of gravity of area 0 and area 1 and a horizontal line ATAN (R1.Y-R0.Y, R1.X-R0.X) When both operands equal 0, calculation will return a result of 0 and OK will display.

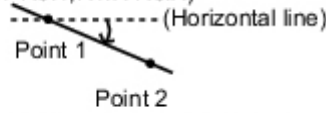
AND (operand 1, operand 2)	Calculates the logical product. When one of two operands is 0, calculation will return a result of 0, and for all other cases, will return a result of -1.
OR (operand 1, operand 2)	Calculates the logical sum. When both operands are 0, calculation will return a result of 0 and for all other cases, will return a result of -1.
NOT (operand)	Calculates the logical NOT. When the operands equal 0, calculation will return a result of -1 and for all other cases, will return a result of 0 be returned.
ABS (operand)	Calculates the absolute value.
MAX (operand 1, operand 2)	The larger of 2 operands will be returned.
MIN (operand 1, operand 2)	The smaller of 2 operands will be returned.
MOD (dividend, divisor)	Calculates the remainder when dividing the dividend with the divisor. To calculate the remainder, if the number being used is a real number, round off the portion after the decimal point of the real number and then execute the calculation. The result is the remainder after division of the integer. (Example) MOD (13.4) Result: 1 (the remainder when dividing 13 by 4) MOD (25.68,6.99) Result: 5 (the remainder when dividing 26 by 7)
SQRT (operand)	Calculates the square root. When the operand is a negative number, calculation will return a result of 0. Judgement will be NG.
ANGL (Y-axis component, X-axis component)	Calculates the angle made by straight line that connects 2 points (center of gravity/center of model). Calculates the angle relative to the horizontal line. The result will be returned within the range of -180 to 180. (Example) When calculating the angle produced by the straight lines that join the gravity of Area 0 and that of Area 1 ANGL(R1.Y-R0.Y,R1.X-R0.X)  When both the two operands are equal to 0, "0" will be returned, and the judge will become NG.
ANGL (first linear coefficient A, first linear coefficient B, first linear coefficient C, second linear coefficient A, second linear coefficient B, second linear coefficient C)	Data of 2 lines is used to obtain the angle formed by the 2 lines. (Example) Use line data at scan edge position 1 and scan edge position 2 to obtain the angle formed by the two lines ANGL (U1.A, U1.B, U1.C, U2.A, U2.B,U2.C)
DIST (X-coordinate of first point, Y-coordinate of first point, X-coordinate of second point, Y-coordinate of second point)	Calculates the distance between 2 points (center of gravity/center of model). (Example) When calculating the distance between the gravity of Area 0 and that of Area 1 DIST(R0.X,R0.Y,R1.X,R1.Y) The following calculation will be performed internally. $\sqrt{(R1.X-R0.X)^2+(R1.Y-R0.Y)^2}$

DIST (Linear coefficient A, linear coefficient B, linear coefficient C, X coordinate, Y coordinate)	A line and a point are specified to obtain the vertical distance between the line and point. (Example) Obtain the distance between the linear regression at scan edge position 1 and edge position 2 DIST (U1.A, U1.B, U1.C, U2.X, U2.Y)
X (first linear coefficient A, first linear coefficient B, first linear coefficient C, second linear coefficient A, second linear coefficient B, second linear coefficient C)	Calculates intersection (X coordinate) of data for 2 lines (Example) Obtain the X coordinate of the intersection between the lines at scan edge position 1 and scan edge position 2 X (U1.A, U1.B, U1.C, U2.A, U2.B, U2.C)
Y (first linear coefficient A, first linear coefficient B, first linear coefficient C, second linear coefficient A, second linear coefficient B, second linear coefficient C)	Calculates intersection (Y coordinate) of data for 2 lines (Example) Obtain the Y coordinate of the intersection between the lines at scan edge position 1 and scan edge position 2 Y (U1.A, U1.B, U1.C, U2.A, U2.B, U2.C)

Expression Usage Examples

Perform Judgement by Combining Unit Judgement Results

Example 2: Perform judgement by combining the judgement results of unit 0 and unit 1

If a judgement of OK for both unit 0 and unit 1 is achieved, a judgement of OK for the calculation will be achieved.

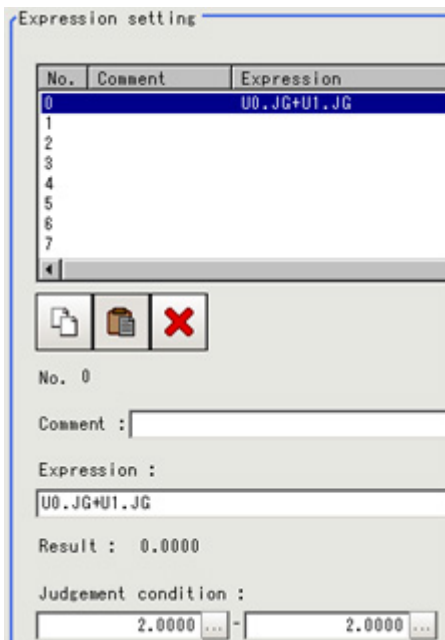

Step 1: The sum of the judgement results (U0.JG, U1.JG) for unit 0 and unit 1 is set in the expression.

The sum of adding the judgement value (1: OK/-1: NG) based on the unit 0 judgement conditions and the judgement value (1: OK/-1: NG) based on the unit 1 judgement conditions is displayed in "Result".

Step 2: The expression result of step 1 is judged based on judgement upper and lower limits.

When "2" is set for both the judgement upper and lower limits, the calculation judgement of OK is

achieved when both units 0 and 1 are judged as OK.

Judgement results of unit 0 (Judgement value)	Judgement results of unit 1 (Judgement value)	Expression result (Summation results of judgement values for units 0 and 1)	Judgement result of expression
OK (1)	OK (1)	2	OK
NG (-1)	OK (1)	0	NG
OK (1)	NG (-1)	0	NG
NG (-1)	NG (-1)	-2	NG

Using Values of Other Expressions

Up to 8 expressions can be set in 1 expression unit.

The value of other expressions set within the same unit can also be used.

Since expression results obtained by the expression are displayed as D00 to D07 and judgement results of expression are displayed as J00 to J07, this is set to "U3.D00" (results of expression 0 set for processing item [Calculation] of unit number "3") using "unit number calculation results".

For the following scene settings:

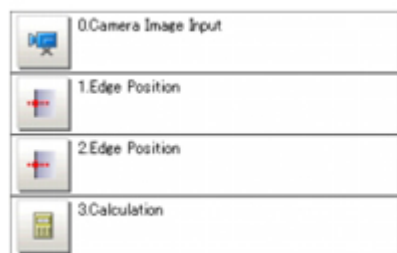

Example 1: Calculate the reference position distance and measurement results distance for the edge position and output the difference between the two.

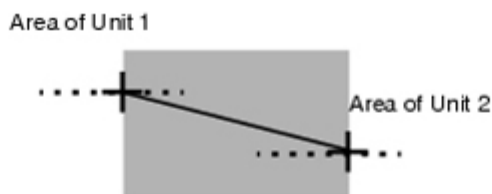

<p>No. 0</p> <p>Comment <input type="text"/></p> <p>Expression <code>DIST(U1.SX,U1.SY,U2.SX,U2.SY)</code></p> <p>Result 147.7576</p> <p>Judgment condition <input type="text" value="100.0000"/> - <input type="text" value="200.0000"/></p>	<p>No. 1</p> <p>Comment <input type="text"/></p> <p>Expression <code>DIST(U1.X,U1.Y,U2.X,U2.Y)</code></p> <p>Result 150.7031</p> <p>Judgment condition <input type="text" value="100.0000"/> - <input type="text" value="200.0000"/></p>
<p>No. 2</p> <p>Comment <input type="text"/></p> <p>Expression <code>U3.D00-U3.D01</code></p>	

Substitute the operational results of Expression 0(DO0) and Expression 1(DO1)

Set expressions in the following manner.

- Calculation 0: `DIST (U1.SX, U1.SY, U2.SX, U2.SY)`
This expression is used to calculate the distance between the reference positions of unit 1 and unit 2.
The function "DIST" calculates the distance between 2 points.
- Calculation 1: `DIST (U1.X,U1.Y,U2.X,U2.Y)`
This expression is used to calculate the distance between the measurement positions of unit 1 and unit 2.
The function "DIST" calculates the distance between 2 points.
- Calculation 2: `U3.D01 - U3.D00`
(Unit 3: Calculation [Calculation 1] - Unit 3: Calculation [Calculation 0])
This equation is used to calculate the difference between results of Calculation 1 and Calculation 0 in unit 3 (in this example, Operation).

Note**Calculating order of expressions**

- Expressions that use the expression results of other expressions must be set with an expression number that is higher than that of the substituted expression. If it is set with a number smaller than the number of the substituted expression, previous expression results of the substituted expression will be inserted.

Calculating order

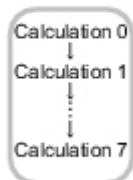

Calculate the distance between the two points in the inspection region in

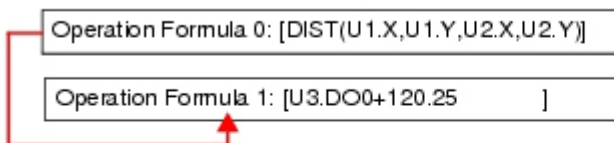

When you substitute these equations with each other

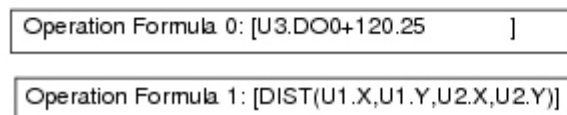

Since the calculation of operation formula 0 is earlier than operation formula 1, the last operation result of operation formula 1 will be substituted into U3 D01

Counting Number of Measurements

No.	0
Comment :	
Expression :	U0.JG+U1.JG

The measurement count is counted by adding "1" to each calculation number 0.

Note

- When expression results are cleared or the power is turned off, U3.D00 will return to "0" and the measurement counts will also be reset.

Key Points for Test Measurement and Adjustment (Calculation)

The following content is displayed in the "Detail result" area as text.

Displayed items	Description
Judge	Judgement result
Expression0	Expression result of Expression 0
Expression1	Expression result of Expression 1
Expression2	Expression result of Expression 2
Expression3	Expression result of Expression 3
Expression4	Expression result of Expression 4

Expression5	Expression result of Expression 5
Expression6	Expression result of Expression 6
Expression7	Expression result of Expression 7

Measurement Results for Which Output Is Possible (Calculation)

The following values can be output using processing items related to results output. It is also possible to reference measurement values from expressions and other processing units.

Measurement items	Character string	Description
Judgement	JG	Judgement result
Data 0	D00	Expression result of expression 0
Data 1	D01	Expression result of expression 1
Data 2	D02	Expression result of expression 2
Data 3	D03	Expression result of expression 3
Data 4	D04	Expression result of expression 4
Data 5	D05	Expression result of expression 5
Data 6	D06	Expression result of expression 6
Data 7	D07	Expression result of expression 7
Judge 0	J00	Judgement result of expression 0
Judge 1	J01	Judgement result of expression 1
Judge 2	J02	Judgement result of expression 2
Judge 3	J03	Judgement result of expression 3
Judge 4	J04	Judgement result of expression 4
Judge 5	J05	Judgement result of expression 5
Judge 6	J06	Judgement result of expression 6
Judge 7	J07	Judgement result of expression 7

Line Regression

Calculates the line that generates the shortest total distance from multiple measurement coordinates (Line Regression).
It can also calculate the intersection and angle between two lines and the distance between a line and a point.

Used in the Following Case

- For computing a line and for calculating the intersection and distance of lines

· Approximate multiple measurement coordinates with a straight line

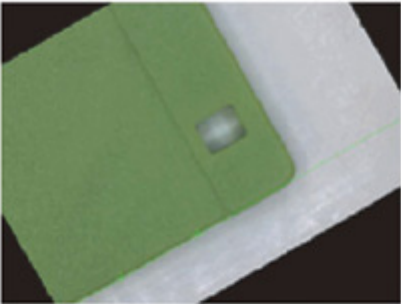

· Calculate the intersection and angles of two lines.

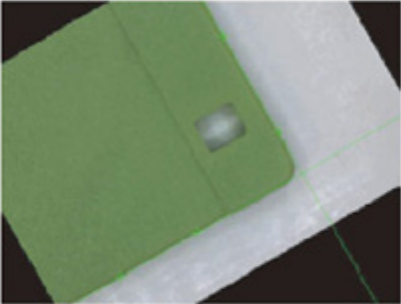

· Calculate the distance from the line to the point

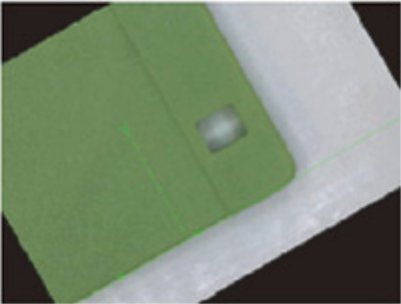

Important

- Do not set processing units that perform affine transformations such as position compensation between Line Regression and a unit that inputs for Line Regression.

Function Selection (Line Regression)

Functions are selected depending on application.

1. In the Item Tab area, tap [Select function].
2. Select a function.

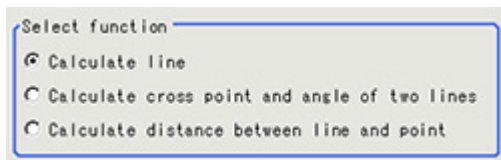

Setting item	Set value [Factory default]	Description
Select function	· [Calculate line]	Calculates a straight line providing the shortest distance from multiple points (Line Regression). Set the Line 0 tab.
	· Calculate cross point and angle of two lines	Calculates the intersection and angle between 2 Line Regressions. Set the Line 0 tab and Line 1 tab.
	· Calculate distance between line and point	Calculates the distance between a Line Regression and a point. Set the Line 0 and Point tab.

Line 0 (Line Regression)

1. In the Item Tab area, tap [Line 0].
2. Set each item in the "Parameter" area.

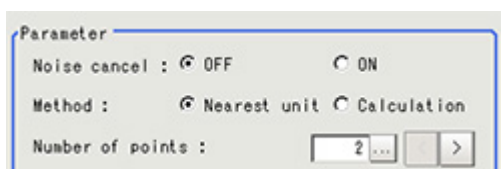

Setting item	Set value [Factory default]	Description
Noise cancel	· [OFF] · ON	When a check is placed at [ON], an approximate line is found by excluding the points with large deviation among the measured points.
Method	· [Nearest unit] · Calculation	Nearest unit: Calculated from data of several continuous coordinate measurement units that were just performed. The number of units referenced is indicated by the Number of points. If a unit where coordinate measurement is not performed is included in Nearest unit, calculation will not be performed properly and measurement will be NG. Calculation: Calculated from expression set up. Reference: ▶ When Calculation is Selected (p.353)
Number of points	[2] to 8	Set up the number of coordinate points used for calculation.

3. Tap [OK].

When Calculation is Selected

1. Tap [...].

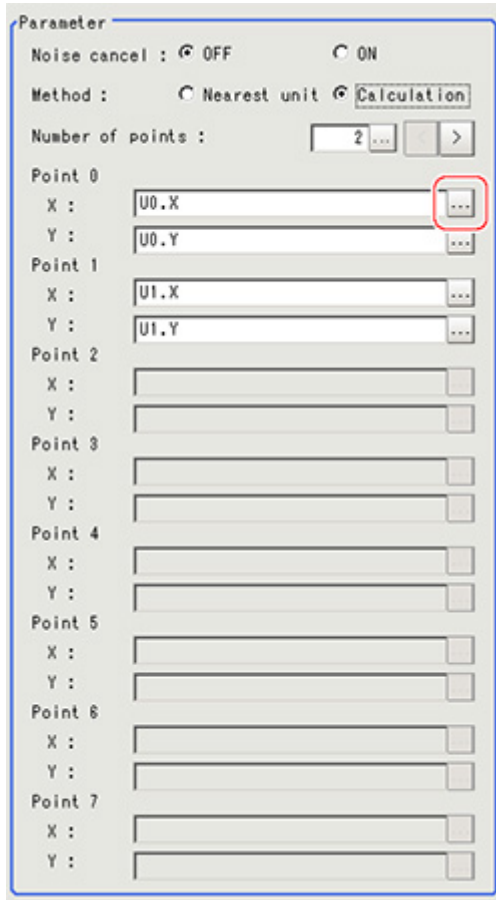

The Setting Expression window is displayed.

2. Set up the expression.

Sub-menus that can be set in expressions depending on the processing unit are displayed. When the sub-menu is tapped, it is added to the Exp.

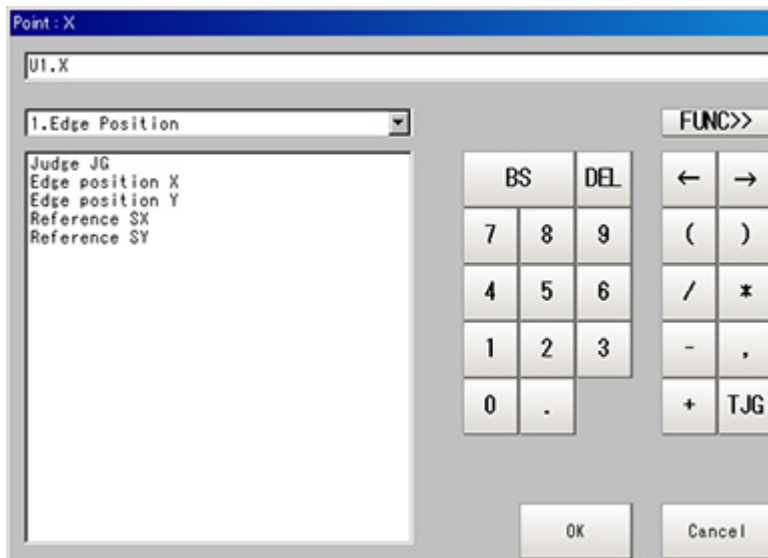

Reference: ▶ Layout of Setting Expression Window (p.343)

3. After setting up the expression, tap [OK].
The expression is confirmed.

Line 1 (Line Regression)

"Line 1" is only valid if "Calculate cross point and angle of two lines" is selected in Select function.

- The set up method is the same as for [Line 0].
Reference: ▶ Line 0 (Line Regression) (p.352)

Point (Line Regression)

"Point" is only valid if "Calculate distance between line and point" is selected in "Select function".

1. Tap [Point] in the Item Tab area.
2. Tap [...].

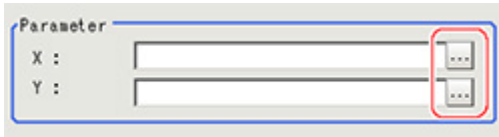

The Setting Expression window is displayed.

3. Set up the expression.
Sub-menus that can be set in expressions depending on the processing unit are displayed. When the sub-menu is tapped, it is added to the Exp.

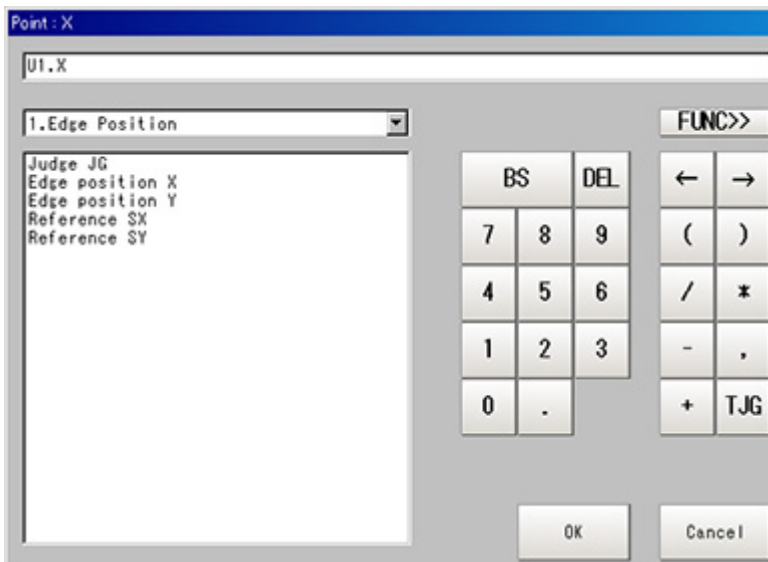

Reference: ▶ Layout of Setting Expression Window (p.343)

4. After setting up the expression, tap [OK].
The expression is confirmed.

Key Points for Test Measurement and Adjustment (Line Regression)

The following content can be confirmed in the "Detail result" area using text.

Displayed items	Description
Judge	Judgement result
Line parameter 0 A	Parameter A of line 0
Line parameter 0 B	Parameter B of line 0
Line parameter 0 C	Parameter C of line 0
Line parameter 1 A	Parameter A of line 1 (only displayed when calculating the intersection of 2 lines)
Line parameter 1 B	Parameter B of line 1 (only displayed when calculating the intersection of 2 lines)
Line parameter 1 C	Parameter C of line 1 (only displayed when calculating the intersection of two lines)
Cross point X	X coordinate of intersection (only displayed when calculating the intersection of two lines or calculating the distance between a line and a point)
Cross point Y	Y coordinate of intersection (only displayed when calculating the intersection of two lines or calculating the distance between a line and a point)
Angle	Angle between two lines (only displayed when calculating the intersection of two lines)
Point X	X coordinate of input point (only displayed when calculating the distance between a line and a point)
Point Y	Y coordinate of input point (only displayed when calculating the distance between a line and a point)
Distance	Distance between line 0 and an input point (only displayed when calculating the distance between a line and a point)

Measurement Results for Which Output Is Possible (Line Regression)

The following values can be output using processing items related to results output. It is also possible to reference measurement values from expressions and other processing units.

Measurement items	Character string	Description
Judgement	JG	Judge
Line Param. 0	A	Parameter A of line 0
Line Param. 0	B	Parameter B of line 0
Line Param. 0	C	Parameter C of line 0
Line Param. 1	A1	Parameter A of line 1
Line Param. 1	B1	Parameter B of line 1
Line Param. 1	C1	Parameter C of line 1
Cross point X	CX	X coordinate of intersection
Cross point Y	CY	Y coordinate of intersection
Angle	TH	Angle between two lines
Point X	PX	X coordinate of input point
Point Y	PY	Y coordinate of input point
Distance	DS	Distance between line 0 and input point

Circle Regression

Calculates the circle that generates the shortest total distance from multiple measurement coordinates (Circle Regression).

Used in the Following Case

- This is used when calculating the center and radius of a circle.

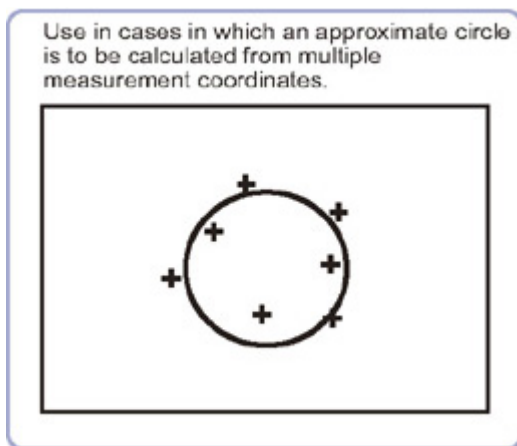

Important

- Do not set processing units that perform affine transformations such as position compensation between Circle Regression and a unit that inputs for Circle Regression.

Parameter Settings (Circle Regression)

- Select a setting method.



Setting item	Set value [Factory default]	Description
Method	<ul style="list-style-type: none"> [Nearest unit] Calculation 	<p>Nearest unit: calculated from the unit data of several continuous coordinates that were just measured. The number of units referenced is indicated by the Number of points. If a unit where coordinate measurement is not performed is included in Nearest unit, calculation will not be performed properly and measurement will be NG.</p> <p>Calculation: Calculated from expression set up.</p> <p>Reference: ▶ When Calculation is Selected (p.357)</p>
Number of points	[3] to 8	Set up the number of coordinate points used for calculation.

- Tap [OK].

When Calculation is Selected

1. Tap [...].

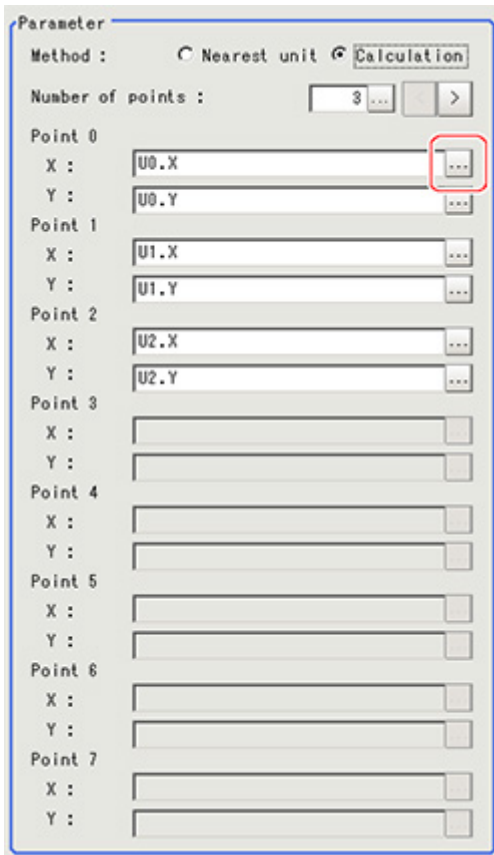

The Setting Expression window is displayed.

2. Set up the expression.

Sub-menus that can be set in expressions depending on the processing unit are displayed. When the sub-menu is tapped, it is added to the Exp.

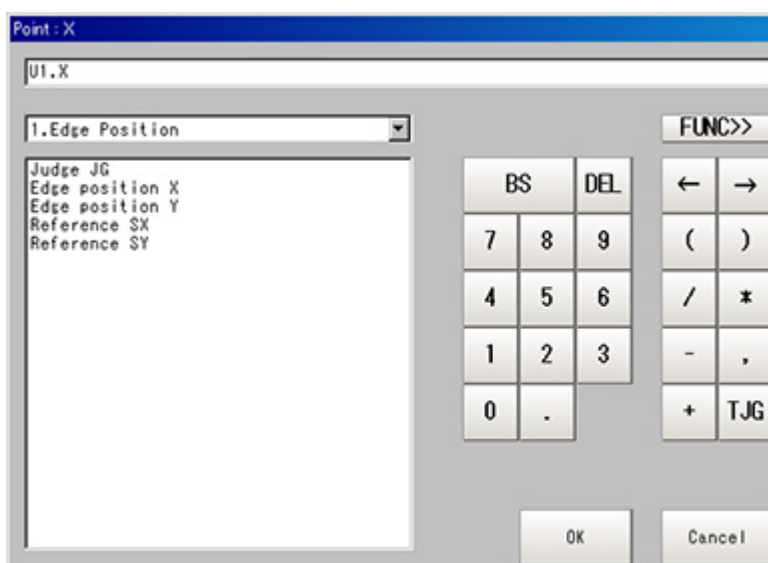

Reference: ▶ Layout of Setting Expression Window (p.343)

- After setting up the expression, tap [OK].
The expression is confirmed.

Key Points for Test Measurement and Adjustment (Circle Regression)

The following content can be confirmed in the "Detail result" area using text.

Displayed items	Description
Judge	Judgement result
Central X	Central X
Central Y	Central Y
Radius R	Radius

Measurement Results for Which Output Is Possible (Circle Regression)

The following values can be output using processing items related to results output. It is also possible to reference measurement values from expressions and other processing units.

Measurement items	Character string	Description
Judgement	JG	Judge
Center Axis	X	Center Axis X
Center Axis	Y	Center Axis Y
Radius	R	Radius

Calibration+

This is a processing item for just FZ3-H □□□ series high grade controllers.

Execute calibration.

A calibration parameter that corrects coordinate values is generated in this processing item. There is no correction for area and other feature quantities.

Four actual coordinates must be indicated in order to perform a calibration.

Calibration is also available for camera image input and the calibration data from just prior to the unit referencing calibration data becomes effective.

Used in the Following Case

- When you want to set up calibration for a distorted image while performing image processing

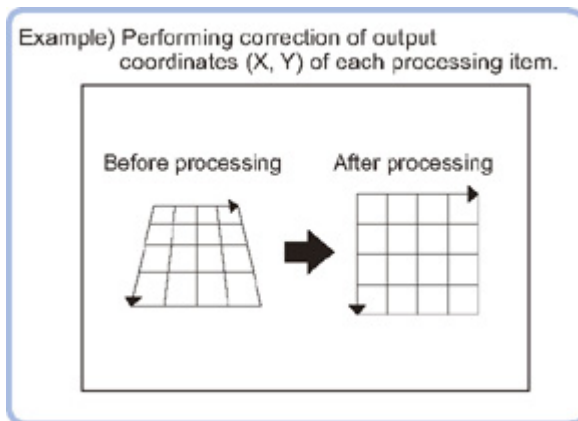

Important

- When FZ3-H □□□ series dedicated processing items are used, processing is carried out that reduces the processing time from the second time on. Therefore, when measuring the same image, the processing for the first time after the controller is started up may be longer than the processing time from the second time on.
- Please make sure the points used for calibration are not unevenly distributed in the field of view. If they are unevenly distributed, correct calibration parameters will not be obtained. Ideally, please indicate points such that the four vertices of a rectangle are included in the points used for calibration.

Calibration (Calibration+)

Sets the calibration method.

Specifying Points and Setting (Point Specification)

This is a method for performing calibration by specifying arbitrary points (in pixels).

Input the actual coordinates for the specified position. Up to 9 points can be indicated.

1. In the "Calibration setting" area, select "Point coordinate".



2. Tap the first point on the screen.
3. Input the actual coordinates for the specified point.
The actual coordinate input window is displayed.

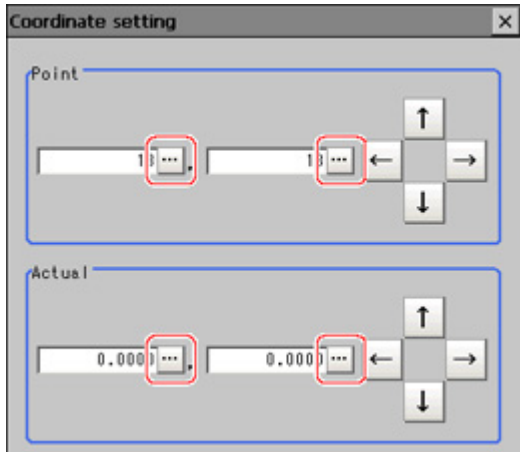

Actual coordinate	Set value [Factory default]
Point coordinate X, Y	0.0000 to 9999.9999 [Point you tapped in the window]
Actual coordinate X, Y	-99999.9999 to 99999.9999 [0]

4. Subsequently set up in the same manner.
5. Tap [Generate calibration parameters].

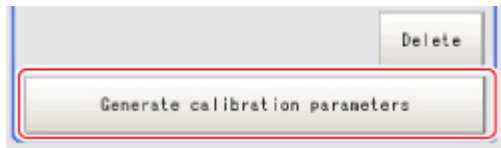

The calibration parameters will be generated.

- If this succeeds,
the Calibration parameter status changes from "The parameter is not generated" to "The parameter is the latest".
- If this fails,
"Failed to generate parameters" is displayed.

Setting Calibration through Sampling Measurement (Sampling)

This is a method for setting calibration based on measurement results. Calibration parameters are calculated automatically when a registered model is searched and the actual coordinates for that position entered.

1. In the "Calibration setting" area, select "Sampling".



2. In the "Sampling" area, tap [Regist model].

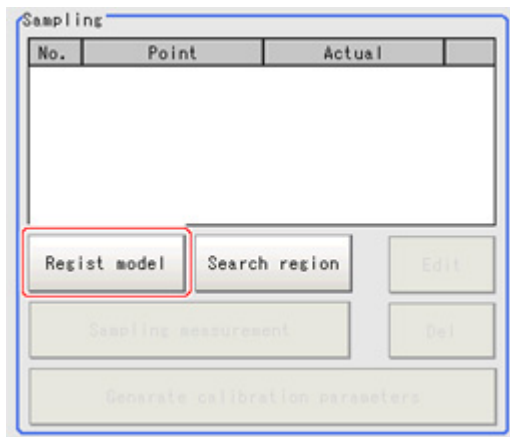

3. Use the Drawing tools to register the model.

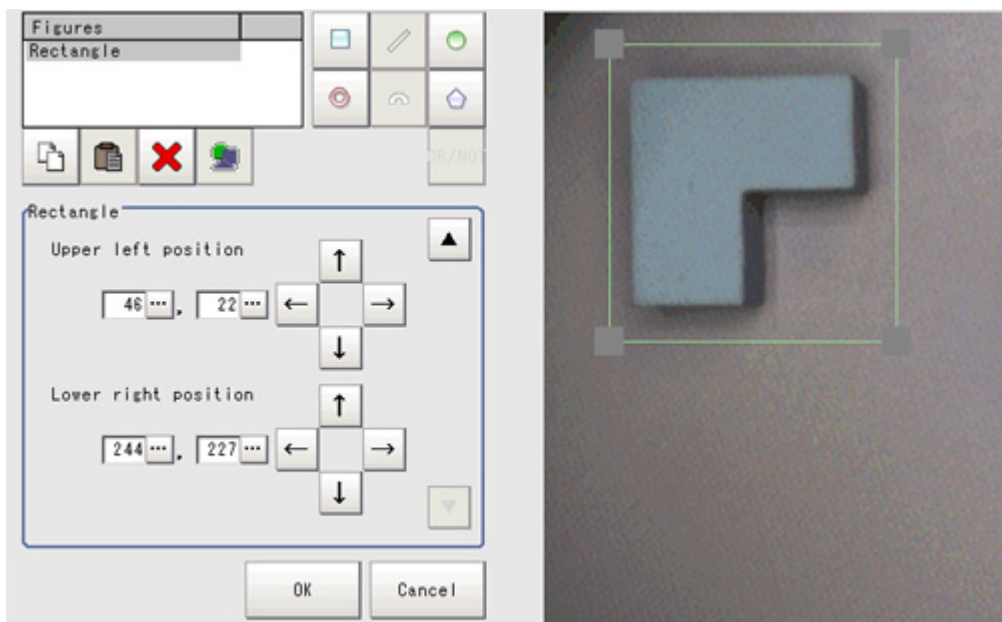

4. Adjust the search region as necessary.

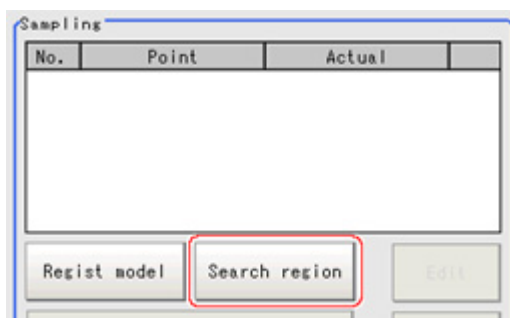

5. Tap [Sampling measurement].

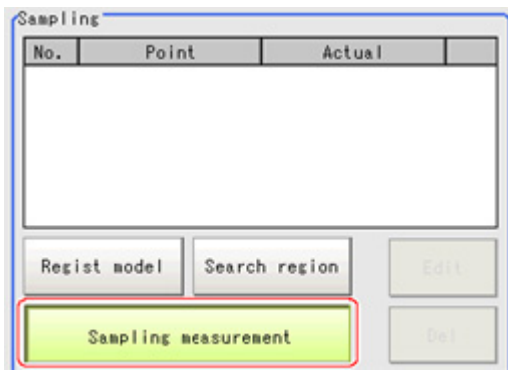

Measurement is performed.

The search result (cross-shaped cursor) is displayed in the Image Display area, and the Sampling coordinate input window is displayed.

6. In the Sampling Coordinate window, enter the X and Y values.

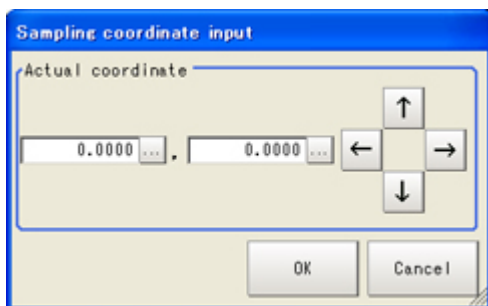

7. Tap [OK].

Point coordinates and actual coordinates are registered in the "Sampling" area.

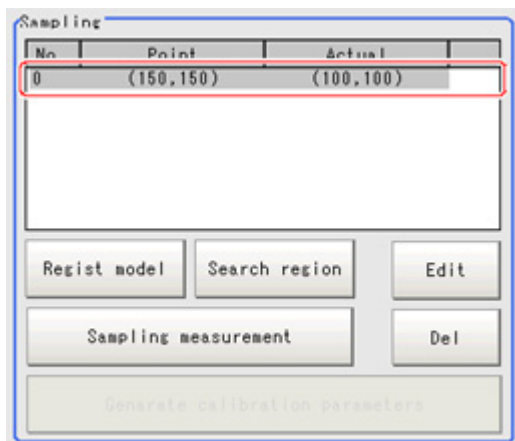

8. Move the object to be measured and repeat the Steps Reference: ▶ 2(p.361) to Reference: ▶ 7(p.362) .
9. Tap [Generate calibration parameters].



The calibration parameters will be generated.

Calibration parameter status
The parameter is the latest.

Measurement Results for Which Output Is Possible (Calibration+)

The following values can be output using processing items related to results output. It is also possible to reference measurement values from expressions and other processing units.

Measurement items	Character string	Description
Judgement	JG	Judgement result

Set Unit Data

Used in the Following Case

- When you want to overwrite processing unit data while measuring

Example) Adjust the search range based on the size of measurement object.

- 0. Camera image
- 1. Edge position
- 2. Edge position
- 3. Set unit data
- 4. Set unit data
- 5. Classification

- Measurement the width of the measurement object by "1 Edge position" and "2 Edge position"
- Adjust the search range of "5 Classification" based on this result.

Change the measured X coordinate to the upper left X coordinate of measurement area in the "5 Classification"

Change the measured X coordinate to the upper left X coordinate of measurement area in the "5 Classification"

Parameter Settings (Set Unit Data)

- Select the target unit to overwrite.

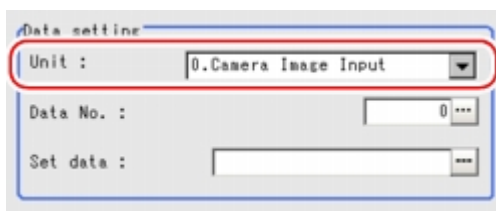

- Tap [...] for "Data No." and set the target data number.
The selected image is displayed in the image area.

Data setting
Unit : 0.Camera Image Input
Data No. : 0
Set data :

The designated data No. will be different depending on the processing item.
Reference: ▶ "External Reference Tables" of the "User's Manual" (p.255)

3. Overwrite details are set up using an expression.

Data setting
Unit : 0.Camera Image Input
Data No. : 0
Set data :

Reference: ▶ Layout of Setting Expression Window (p.343)

4. Tap [OK].
The settings are finalized.

Measurement Results for Which Output Is Possible (Set Unit Data)

The following values can be output using processing items related to results output. It is also possible to reference measurement values from expressions and other processing units.

Measurement items	Character string	Description
Judgement	JG	Latest processing unit judgement result
Setting data	DT	Calculation result of setup data (formula)

Get Unit Data

Used in the Following Case

- When you want to acquire processing unit data while measuring

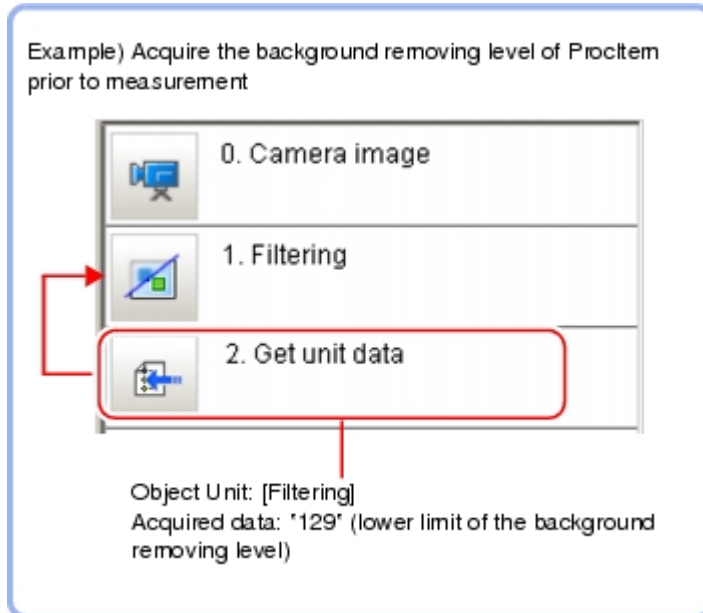

Parameter Settings (Get Unit Data)

1. In the "Data setting" area, tap [▼] for [Unit] and specify a target unit.

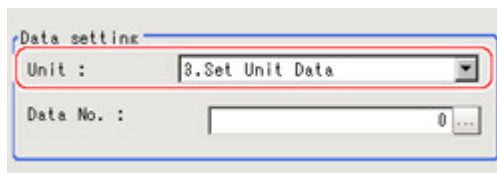

2. Tap [...] for "Data No." and specify the desired data No.

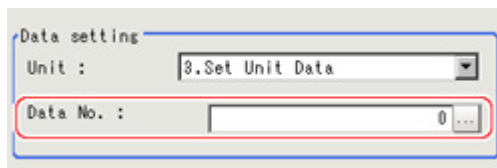

The designated data No. will be different depending on the processing item.

Reference: ▶ "External Reference Tables" of the "User's Manual" (p.255)

3. Tap [OK].
The settings are finalized.

Measurement Results for Which Output Is Possible (Get Unit Data)

The following values can be output using processing items related to results output. It is also possible to reference measurement values from expressions and other processing units.

Measurement items	Character string	Description
Judgement	JG	The latest processing unit judgement result
Data	DT	Processing unit data acquired

Set Unit Figure

Used in the Following Case

- When changing the measurement area based on the measurement results

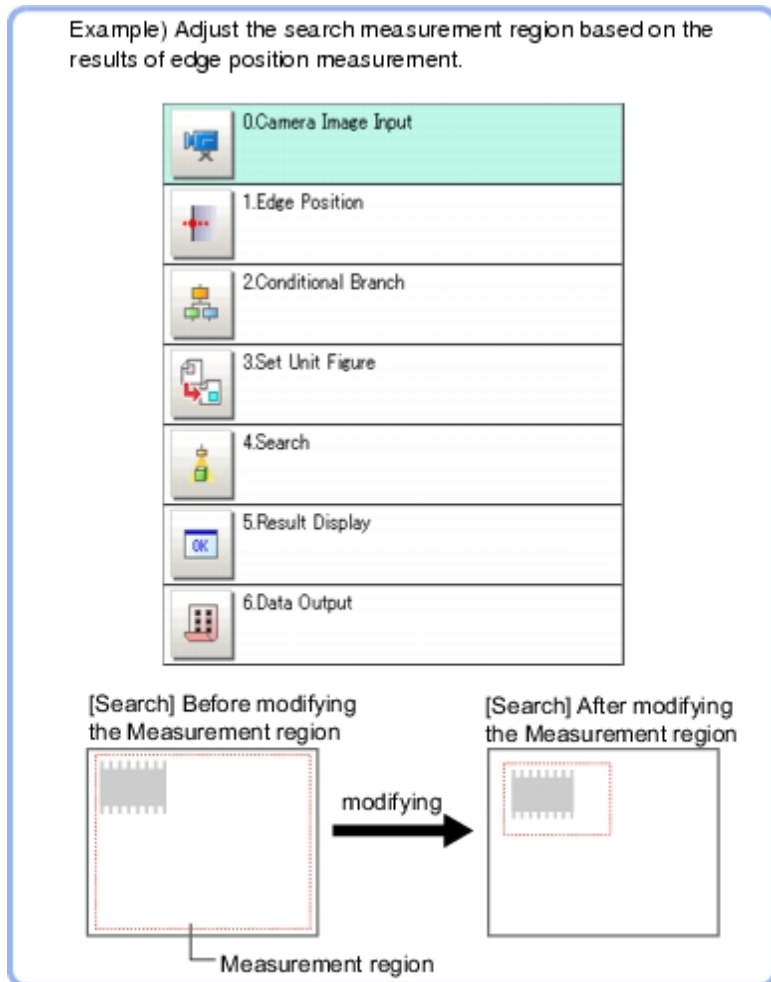

Important

- Do not insert "Input image" processing items or "Compensate image" processing items between the "Set Unit Figure" and the target processing unit. The processing unit figure may go out.
Reference: ▶ [Input image \(p.11\)](#)
Reference: ▶ [Compensate image \(p.291\)](#)

Parameter Settings (Set Unit Figure)

- Select the target unit to overwrite.

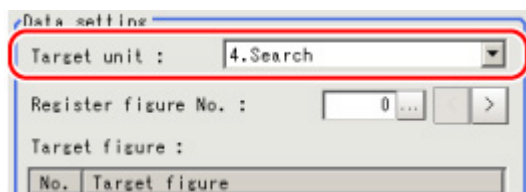

- Tap [...] for "Register figure No." and specify a figure number for modification.

The selected image is displayed in the image area.

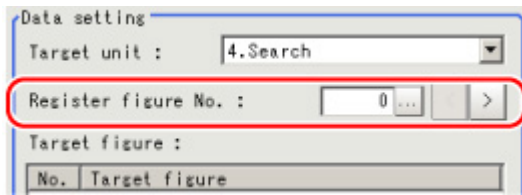

The assignment of figure numbers varies depending on processing items. The following table shows the register figure numbers assigned to each processing item.

Processing item	Figure No.	Item
Search	0	Model Registration
	1	Region Setting (Measurement Region Range)
Flexible Search	0	Model (Model 0)
	1	Model (Model 1)
	2	Model (Model 2)
	3	Model (Model 3)
	4	Model (Model 4)
	5	Region Setting (Measurement Region Range)
Sensitive Search	0	Model Registration
	1	Region Setting (Measurement Region Range)
ECM Search	0	Model - Edit
	1	Region Setting (Measurement Region Range)
	2	Model - Mask
	3	Error model - Edit
	4	Error model - Mask
EC Circle Search	0	Model Registration
	1	Region Setting (Measurement Region Range)
Shape Search+	0	Model Registration
	1	Region Setting (Measurement Region Range)
Classification	0	Model (Index 0: Model 0)
	1	Model (Index 0: Model 1)
	2	Model (Index 0: Model 2)
	3	Model (Index 0: Model 3)
	4	Model (Index 0: Model 4)
	5	Model (Index 1: Model 0)
	6	Model (Index 1: Model 1)
	.	.
	.	.
	.	.
179	Model (Index 35: Model 4)	
180	Auto registration region setting	
Edge Position	0	Region setting
Edge Pitch	0	Region setting
Scan Edge Position	0	Region setting
Scan Edge Width	0	Region setting

Color Data	0	Region setting
Gravity and Area	0	Region setting
Labeling	0	Region setting
Labeling+	0	Region setting
Defect	0	Region setting
Precise Defect	0	Region setting
Fine Matching	0	Model Registration
Character Inspection	0	Region setting
Model Dictionary	0	Model (Index 0: Model 0)
	1	Model (Index 0: Model 1)
	2	Model (Index 0: Model 2)
	3	Model (Index 0: Model 3)
	4	Model (Index 0: Model 4)
	5	Model (Index 1: Model 0)
	6	Model (Index 1: Model 1)
	.	.
	.	.
.	.	
179	Model (Index 35: Model 4)	
180	Auto registration region setting	
Barcode+	0	Region setting
2D Code+	0	Region setting
Circle Angle	0	Region setting
Position Compensation	0	Region setting
Trapezoidal Correction+	0	Region setting
Filtering	0	Region setting
Background Suppression	0	Region setting
Color Gray Filter	0	Region setting
Extract Color Filter	0	Region setting
Anti Color Shading	0	Region setting
Stripes Removal Filter+	0	Region setting
Halation Cut+	0	Region setting
Polar Transformation	0	Region setting

3. Tap the target figure number for overwriting.

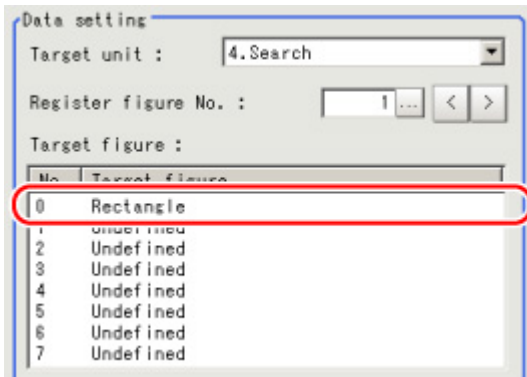

4. Tap the data name you would like to overwrite.

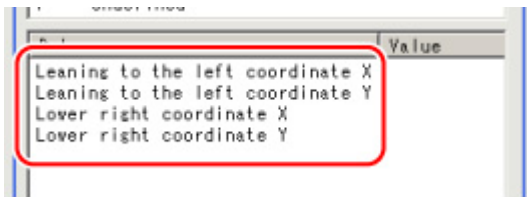

5. Tap [Edit] to set up the overwrite details using an expression.

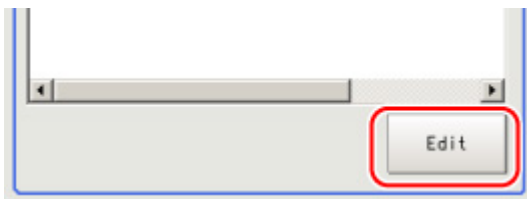

Reference: ▶ Layout of Setting Expression Window (p.343)

6. Tap [OK].

An area is displayed on the image based on settings.



Key Points for Test Measurement and Adjustment (Set Unit Figure)

The following content is displayed in the "Detail result" area as text.

Displayed items	Description
Judge	Judgement result
Target unit	Unit for setting up figures
Register figure No.	Registered figure number
Target figure No.	Target figure number

Measurement Results for Which Output Is Possible (Set Unit Figure)

The following values can be output using processing items related to results output. It is also possible to reference measurement values from expressions and other processing units.

Measurement items	Character string	Description
Judgement	JG	The latest processing unit judgement result
Number of data items	DNO	Number of data items setup
Data 0	DT0	Calculation result of setup data 0
Data 1	DT1	Calculation result of setup data 1
Data 2	DT2	Calculation result of setup data 2
Data 3	DT3	Calculation result of setup data 3
Data 4	DT4	Calculation result of setup data 4
Data 5	DT5	Calculation result of setup data 5
Data 6	DT6	Calculation result of setup data 6
Data 7	DT7	Calculation result of setup data 7
Data 8	DT8	Calculation result of setup data 8
Data 9	DT9	Calculation result of setup data 9
Data 10	DT10	Calculation result of setup data 10
Data 11	DT11	Calculation result of setup data 11
Data 12	DT12	Calculation result of setup data 12
Data 13	DT13	Calculation result of setup data 13
Data 14	DT14	Calculation result of setup data 14
Data 15	DT15	Calculation result of setup data 15
Data 16	DT16	Calculation result of setup data 16
Data 17	DT17	Calculation result of setup data 17
Data 18	DT18	Calculation result of setup data 18
Data 19	DT19	Calculation result of setup data 19

Get Unit Figure

Acquires and displays figures drawn by other processing units.

Used in the Following Case

- When you want to acquire data such as coordinates from figure information

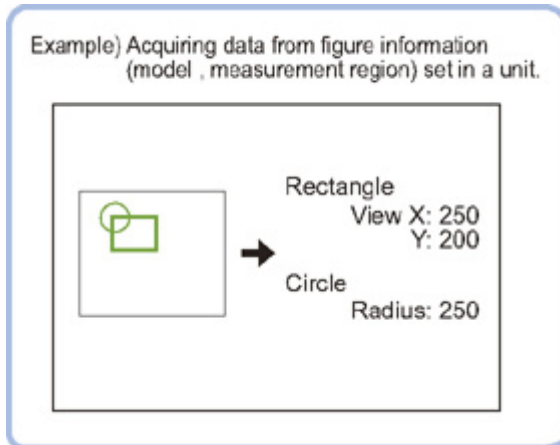

Parameter Settings (Get Unit Figure)

- In the "Data setting" area, tap [▼] for [Unit] and specify a target unit.

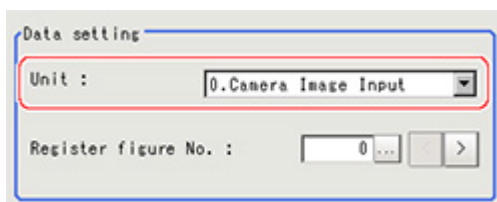

- Tap [...] for [Resister figure No.] and specify Register figure No. you would like to acquire.

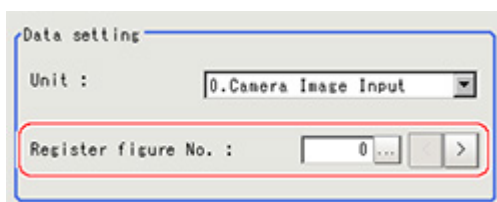

The allocation of registered figures varies depending on processing items.

Reference: ▶ Parameter Settings (Set Unit Figure) (p.368)

- Tap [OK].
The settings are finalized.

Key Points for Test Measurement and Adjustment (Get Unit Figure)

The following content can be confirmed in the "Detail result" area using text.

Displayed items	Description
Judge	Judgement result

Target unit	Target unit which acquired figure
Register figure No.	Acquired figure number

Measurement Results for Which Output Is Possible (Get Unit Figure)

The following values can be output using processing items related to results output. It is also possible to reference measurement values from expressions and other processing units.

Measurement items	Character string	Description
Judgement	JG	The latest processing unit judgement result
Number of figures	NUM	Number of figures acquired
Size of figures	SIZ	Size of figures acquired (number of bytes)
Figure N type (N = 0 to 9)	FNT	Type of figure N 0x0000 → Undefined 0x0001 → Point 0x0002 → Line 0x0004 → Wide line 0x0008 → Rectangle 0x0010 → Ellipse 0x0020 → Circle 0x0040 → Wide circle 0x0080 → Arc 0x0100 → Wide arc 0x0200 → Polygon Set to 0 if no figures are acquired.
Figure N mode (N = 0 to 9)	FNM	Figure N drawing mode 0: OR 1: NOT Set to 0 if no figures are acquired.
Figure N data 00 to 20 (N = 0 to 9)	FND 00 to FND 20	Data 0 to 20 of figure N <ul style="list-style-type: none"> • For points <ul style="list-style-type: none"> 0: X coordinate 1: Y coordinate • For lines <ul style="list-style-type: none"> 0: X coordinate for first point 1: Y coordinate for first point 2: X coordinate for second point 3: Y coordinate for second point • For wide lines <ul style="list-style-type: none"> 0: X coordinate for first point 1: Y coordinate for first point 2: X coordinate for second point 3: Y coordinate for second point 4: Width • For rectangles <ul style="list-style-type: none"> 0: X coordinate for upper left point 1: Y coordinate for upper left point 2: X coordinate for lower right point 3: Y coordinate for lower right point

<p>Figure N data 00 to 20 (N = 0 to 9)</p>	<p>FND 00 to FND 20</p>	<ul style="list-style-type: none"> • For ellipses <ul style="list-style-type: none"> 0: X coordinate for center point 1: Y coordinate for center point 2: Radius in X direction 3: Radius in Y direction • For circles <ul style="list-style-type: none"> 0: X coordinate for center point 1: Y coordinate for center point 2: Radius • For wide circles <ul style="list-style-type: none"> 0: X coordinate for center point 1: Y coordinate for center point 2: Radius 3: Width • For arcs <ul style="list-style-type: none"> 0: X coordinate for center point 1: Y coordinate for center point 2: Radius 3: Start angle of arc 4: End angle of arc • For wide arcs <ul style="list-style-type: none"> 0: X coordinate for center point 1: Y coordinate for center point 2: Radius 3: Start angle of arc 4: End angle of arc 5: Width • For polygons <ul style="list-style-type: none"> 0: Number of vertexes 1: X coordinate for vertex 0 2: Y coordinate for vertex 0 3: X coordinate for vertex 1 4: Y coordinate for vertex 1 5: X coordinate for vertex 2 6: Y coordinate for vertex 2 : : 19: X coordinate for vertex 9 20: Y coordinate for vertex 9 <p>Set to 0 if disabled or no figures are acquired.</p>
--	-----------------------------	---

Trend Monitor

Enables the history of the measurement results to be displayed on the monitor.

Used in the Following Case

- When you want to prevent repeated occurrences of failed product

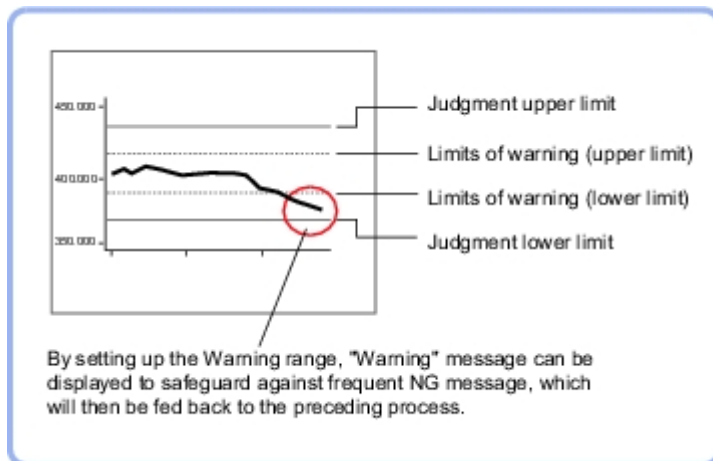

- When you want to analyze the cause of NG

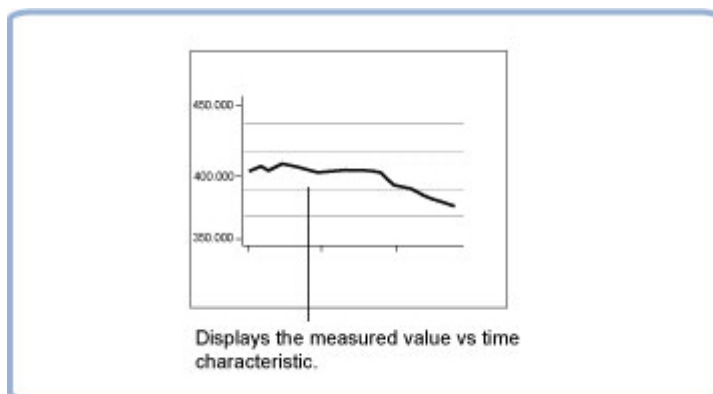

List of Trend Monitor Items

Item name	Description
Measurement	Select the measurement value to be displayed on the trend monitor. Reference: ▶ Measurement Value (Trend Monitor) (p.377)
Display range	Specify the display range. You can scroll the display range of a graph up and down or zoom in/out. Reference: ▶ Display Range (Trend Monitor) (p.377)
Judgement	Set the conditions for deciding when measurement results are judged as OK, and set the warning range for issuing a caution before there are many NG occurrences. Reference: ▶ Judgement Conditions (Trend Monitor) (p.380)
History display	Display measurement history. Reference: ▶ Measurement History Display (Trend Monitor) (p.381)
Data save	Save the measurement results recorded in the trend monitor to USB memory. Reference: ▶ Data Save (Trend Monitor) (p.384)
Output parameter	This item can be changed if necessary. Normally, the factory default value will be used. Specify whether to reflect the judgement result to the overall judgement of the scene. Reference: ▶ Output Parameters (Trend Monitor) (p.385)

Measurement Value (Trend Monitor)

Select the measurement value to be viewed on the trend monitor.
One item can be displayed for each trend monitor unit.

1. Tap [Measurement] in the Item Tab area.
2. In the "Expression" area, tap [...] in "Measurement data".



The Setting Expression window is displayed.

3. Measurement values to be monitored are set up using an expression.
Select a unit number processed before [Trend Monitor]. Even if the unit number after [Trend Monitor] is selected, the graph will not display.

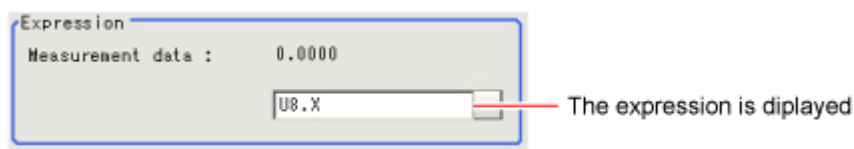

Reference: ▶ Layout of Setting Expression Window (p.343)

4. Set up number of items to save as necessary.



Setting item	Set value	Description
Number of saving	<ul style="list-style-type: none"> • [1000] • 5000 • 10000 • 50000 • 100000 	Set the number of measurement values to save. A maximum of 5000 items can be displayed on the main screen. Measurements that exceed 5000 items are displayed using toggling of pages.

Important

- Trade offs between number of items saved and the controller performance include the following.
 - Increasing the number of items saved delays display processing and affects measurement interval. Please confirm measurement interval prior to performing set up.
 - There is a difference in amount of memory used of approximately 2 MB between 1000 items and 100000 items. Please confirm the amount of memory remaining prior to performing set up.

Display Range (Trend Monitor)

If what you want to see is not on the screen, scroll the graph up and down or zoom in/out.
Also, items displayed horizontally can be toggled.

1. In the Item Tab area, tap [Display range].
A graph is displayed in the Image Display area.

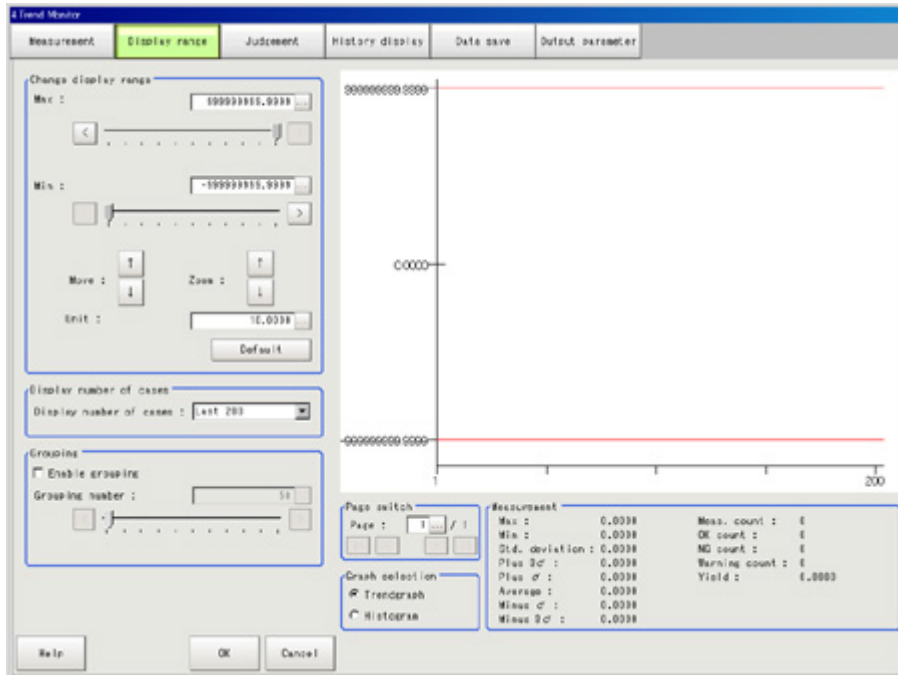

Note

- If the window is entered after measurement is performed a few times and [Default] is tapped on, a display range suitable for these measurement values is automatically set.

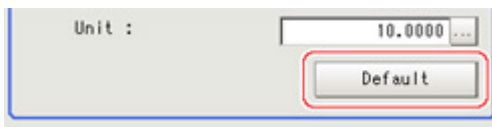

Setting item		Set value [Factory default]	Description
Change display range	Max	-999999999.9999	Sets the upper (highest value) and lower (lowest value) sections of the graph.
	Min	999999999.9999	
	Move	<ul style="list-style-type: none"> • ↑ • ↓ 	Moves up and down the graph itself.
	Zoom	<ul style="list-style-type: none"> • ↑ • ↓ 	Zooms the graph itself in and out.
	Unit	1 to 1000000.0000	Sets the amount of variation generated when the up/down buttons for moving or zooming in/out are pushed.
	Default	-	If several measurements have already been made, an optimal display range is automatically set based on the measurement results.

Display number of cases	<ul style="list-style-type: none"> • [Last 200] • Last 1000 • Last 5000 • Last 10000 • Last 50000 • Last 100000 	Selects the number of items displayed in the horizontal direction on the graph.
Enable grouping	<ul style="list-style-type: none"> • [Checked] • Unchecked 	Draws a rectangle that shows the maximum and minimum of measurement data for every set number of items. This enables viewing the maximum and minimum in a section at a glance.
	0 to 5000 [50]	Sets the number of items that can be grouped.

Move

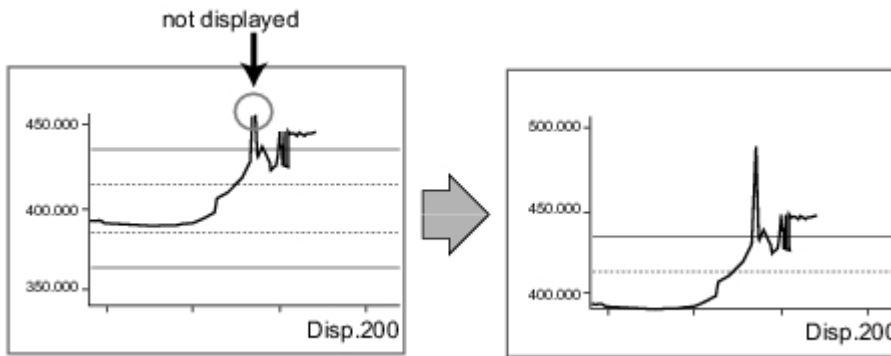

Zoom

Example: Enlarging a part where measurement results were unstable

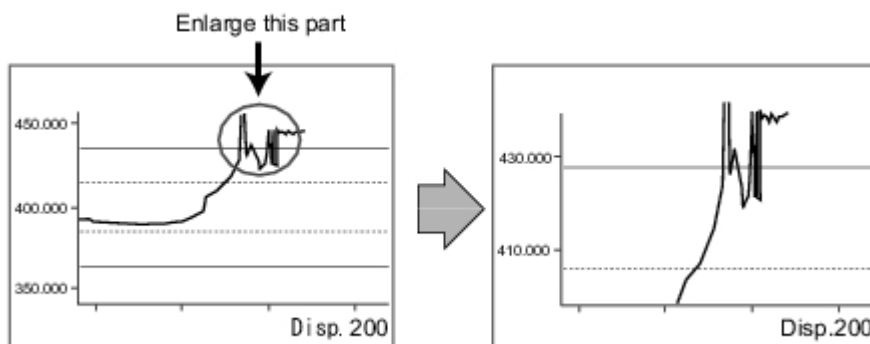

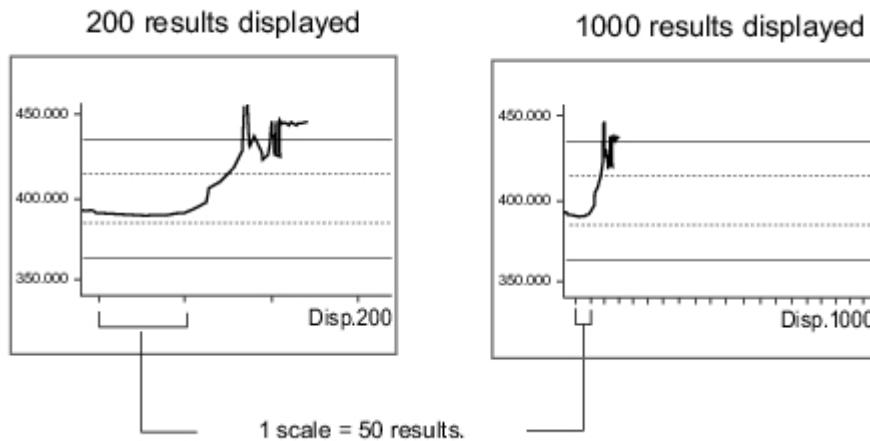

Judgement Conditions (Trend Monitor)

Sets the warning range for prompting caution before large numbers of NGs occur as well as OK/NG judgement conditions.

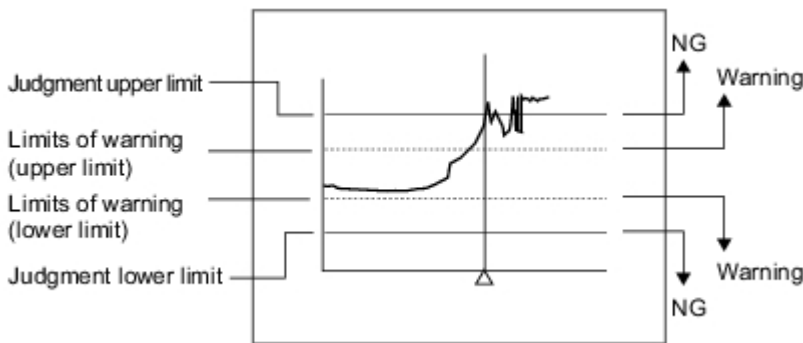

Note

- When a warning occurs, the message "Warning" is displayed on the screen. Notification that an alarm has occurred can also be output to external devices if output-related processing units such as "Parallel Judgement Output" are used to set an arithmetic expression to output measurement results (warnings) from the trend monitor.

- In the Item Tab area, tap [Judgement].
- Set up the judgement condition.

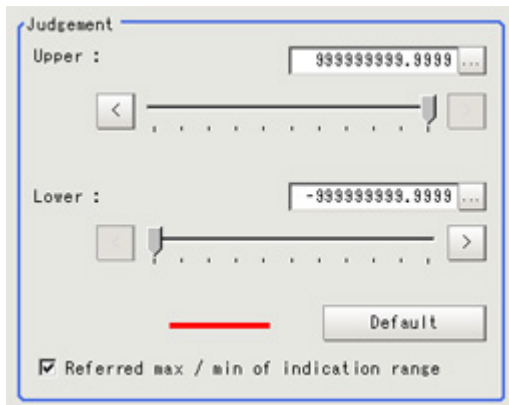

Setting item	Set value [Factory default]	Description
Upper	-999999999.9999 to 999999999.9999	Specify the range where the measurement result is judged to be OK.
Lower	-999999999.9999 to 999999999.9999	
Referred max / min of indication range	<ul style="list-style-type: none"> • [Checked] • Unchecked 	When checked, the judgement range that can be set with the upper and lower values becomes the same as the max. and min. values set in [Display range].

Note

- If the window is entered after measurement is performed a few times and [Default] is tapped on, optimal judgement conditions including maximum and minimum measurement values are automatically set.

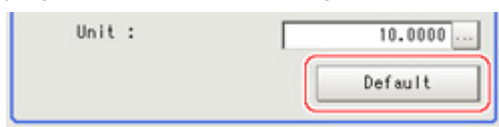

3. In the "Warning" area, specify values for "Upper" and "Lower".
The setup method is the same as the setup method for the "Judgement" area.

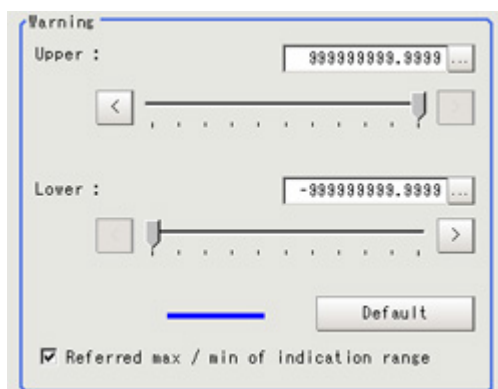

Setting item	Set value [Factory default]	Description
Upper	-999999999.9999 to [999999999.9999]	Specify the warning range for encouraging caution before frequent occurrence of NGs.
Lower	[-999999999.9999] to 999999999.9999	
Referred max / min of indication range	<ul style="list-style-type: none"> • [Checked] • Unchecked 	When checked, the judgement range that can be set with the upper and lower values becomes the same as the max. and min. values set in [Display range].

Measurement History Display (Trend Monitor)

Displays measurement history.

1. Tap [History display] in the Item Tab area.

2. Tap judgement displayed in the "Measurement history" area.

Measurement history

Judge	Count	Value	Time
NG	174	-1.0000	18:21:34
NG	173	-1.0000	18:21:34
NG	172	-1.0000	18:21:34
NG	171	-1.0000	18:21:34
NG	170	-1.0000	18:21:34
NG	169	-1.0000	18:21:34
NG	168	-1.0000	18:21:34
NG	167	-1.0000	18:21:34
NG	166	-1.0000	18:21:34
NG	165	-1.0000	18:21:34
NG	164	-1.0000	18:21:34
NG	163	-1.0000	18:21:34
NG	162	-1.0000	18:21:34
NG	161	-1.0000	18:21:34
NG	160	-1.0000	18:21:34
NG	159	-1.0000	18:21:34
NG	158	-1.0000	18:21:34
NG	157	-1.0000	18:21:34
NG	156	-1.0000	18:21:34
NG	155	-1.0000	18:21:33
NG	154	-1.0000	18:21:33
NG	153	-1.0000	18:21:33
NG	152	-1.0000	18:21:33
NG	151	-1.0000	18:21:33
NG	150	-1.0000	18:21:33
NG	149	-1.0000	18:21:33
NG	148	-1.0000	18:21:33
NG	147	-1.0000	18:21:33
NG	146	-1.0000	18:21:33
NG	145	-1.0000	18:21:33
NG	144	-1.0000	18:21:33
NG	143	-1.0000	18:21:33
NG	142	-1.0000	18:21:33

1 / 1

The measurement values and time are displayed.

In the Image Display area, longitudinal lines displayed at NG positions in the graph show where NG have occurred.

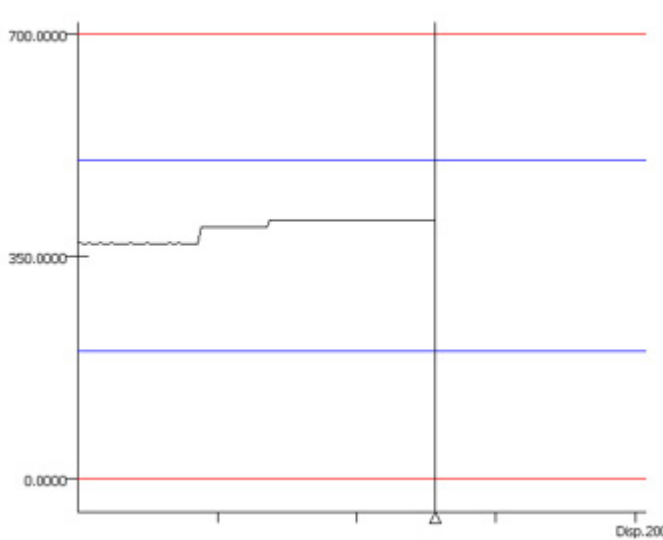

3. Set up a filter as necessary.

Filtering

Judge : All Only OK Only NG

Sort order : ▼

Setting item	Set value [Factory default]	Description
Judge	<ul style="list-style-type: none"> • All • Only OK • [Only NG] 	Sets the judgement results that are displayed.
Sort order	<ul style="list-style-type: none"> • Count ascending • [Count descending] • Value ascending • Value descending 	Sets the sort order for the judgement results to display.

4. Sets up a display graph as necessary.



Setting item	Set value [Factory default]	Description
Graph selection	• [Trend graph]	<p>The vertical direction shows measurement values and horizontal direction shows number of items. This is convenient for showing time elapse and changes in measurement.</p>
	• Histogram	<p>The vertical direction shows number of items and horizontal direction shows measurement values. This is convenient for showing distribution.</p>

Data Save (Trend Monitor)

The measurement results recorded in the trend monitor can be saved in the USB device. Since the data can be saved in CSV format, it can be edited on the PC.

The data to be saved includes all the statistical data, the value and time stamp when NG occurs (up to 36 items) and the measurement result on the graph (up to 1000 items). Up to 100000 items of measurement results can be saved in extended format. The format is as follows.

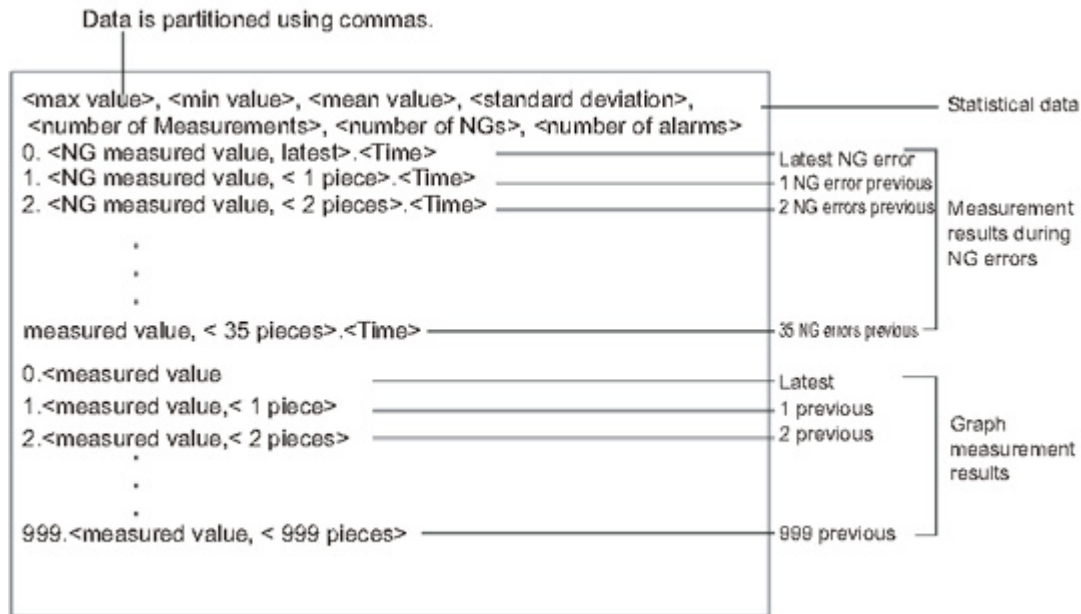

Important

- Please insert USB memory first before saving data. For the USB connection position, see the Instruction Manual.

- In the Item Tab area, tap [Data save].
- Specify format in the "Save setting" area.

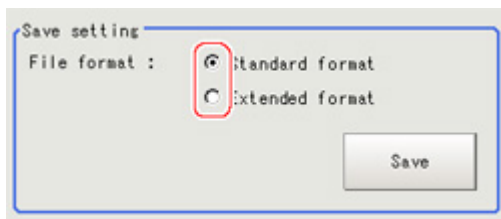

Standard format

Line	Text	Description
1	<Maximum>, <Minimum>, <Average>, <Deviation>, <Count>, <NG count>, <Warning count>	Statistical data
2		
3	0, <NG measured value,latest>, <Time>	Last NG
4	1, <NG measured value,<1 piece>>, <Time>	Last 1 NG
5	2, <NG measured value,<2 piece>>, <Time>	Last 2 NG
:	:	:
38	35, <NG measured value,<35 piece>>, <Time>	Last 35 NG
39		

Measurement results when NG occurs (Max: 36 items)

40	0, <measured value,latest>	Last	Measurement result (Max: 1000 items)
41	1, <measured value,<1 piece>>	Last 1	
42	2, <measured value,<2 piece>>	Last 2	
:	:	:	
1039	999, <measured value,<999 piece>>	Last 999	

Extended format

Line	Text	Description	
1	<Maximum>, <Minimum>, <Deviation>, <Plus 3 σ >, <Plus σ >, <Average>, <Minus σ >, <Minus 3 σ >, <Count>, <OK count>, <NG count>, <Warning count>, <Yield>	Statistical data	
2			
3	0, <judgment result,latest>, <measured value,latest>, <Time>	Last	Measurement result (Max: 100000 items)
4	1, <judgment result,<1 piece>>, <measured value,<1 piece>>, <Time>	Last 1	
5	2, <judgment result,<2 piece>>, <measured value,<2 piece>>, <Time>	Last 2	
:	:	:	
100002	99999, <judgment result,<99999 piece>>, <Last 99999 Measurement>, <Time>	Last 99999	

Note

- The default for the file name is the data save date (example: 0410.csv). If it is half-width alphanumeric characters, it can be changed arbitrarily.

- In the "Save setting" area, tap [Save].
The data is saved to USB memory.

Output Parameters (Trend Monitor)

Specifies whether or not the judgement results of this processing unit is reflected in the scene overall judgement.

- Tap [Output parameter] in the Item Tab area.
- Choose whether or not to reflect this in the scene overall judgement in "Reflect to overall judgement" area.

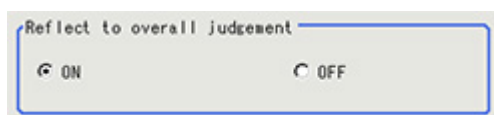

Setting item	Set value [Factory default]	Description
Reflect to overall judgement	<ul style="list-style-type: none"> [ON] OFF 	Enables choosing whether or not the judgement results of this processing unit is reflected in the scene overall judgement.

Key Points for Test Measurement and Adjustment (Trend Monitor)

The following content can be confirmed in the "Detail result" area using text.

Displayed items	Description
Judge	Judgement result
Measurement	Latest measured value
Max	Max. measurement value during recording period
Min	Min. measurement value during recording period
Standard deviation	Standard deviation for measurement values during recording period
Plus 3σ	Average of measurement values during period recorded + standard deviation of the measurement values x 3
Plus σ	Average of measurement values during period recorded + standard deviation of the measurement values
Average	Average value for measurement values during recording period
Minus σ	Average of measurement values during period recorded - standard deviation of the measurement values
Minus 3σ	Average of measurement values during period recorded - standard deviation of the measurement values x 3
Measurement count	Measure count since the beginning of measurement
OK count	Number of measurements since starting to make measurements - NG count in number of measurements
NG count	Number of NG occurrences within the measurement count
Warning count	Warning count within the measurement count
Yield	OK count in number of measurements / Number of measurements since starting to make measurements

Measurement Results for Which Output Is Possible (Trend Monitor)

The following values can be output using processing items related to results output. It is also possible to reference measurement values from expressions and other processing units.

Measurement items	Character string	Description
Judgement	JG	Judgement result
Measurement	DT	Latest measured value
Warning	WN	Existence of warning occurrence
Maximum	MX	Max. measurement value during recording period
Minimum	MN	Min. measurement value during recording period
Deviation	DV	Standard deviation for measurement values during recording period
Plus 3σ	AP3	Average of measurement values during period recorded + standard deviation of the measurement values x 3
Plus σ	AP1	Average of measurement values during period recorded + standard deviation of the measurement values
Average	AV	Average value for measurement values during recording period
Minus σ	AM1	Average of measurement values during period recorded - standard deviation of the measurement values

Minus 3 σ	AM3	Average of measurement values during period recorded - standard deviation of the measurement values x 3
Measurement count	MC	Measure count since the beginning of measurement
OK count	OC	Number of measurements since starting to make measurements - NG count in number of measurements
NG count	NC	Number of NG occurrences within the measurement count
Warning count	WC	Warning count within the measurement count
Yield	YD	OK count in number of measurements / Number of measurements since starting to make measurements

Important

- If the total measurement value data exceeds -1.0×10^{11} to 1.0×10^{11} , the measurement will be disabled (NG).
Regularly clear the measurement values so that the total measurement value data stays within the range.

Image Logging

This is used when saving measurement images to on-board memory, RAMDisk or USB memory. This enables preparation of logging conditions using an expression and is more flexible than the system image logging conditions settings.

However, the settings of this unit are enabled if "None" is set on the [Logging setting] of the main screen [Measure] menu.

If settings that perform image logging for multiple units during measurement are executed, the last settings executed are enabled.

4

Support measurement

Used in the Following Case

- This is used when saving logging images under specific conditions.

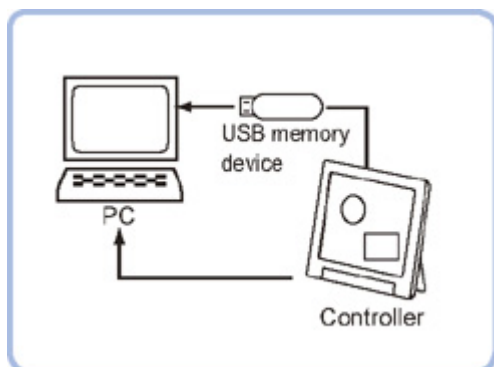

Important

- If several image logging units are set in the flow, saving is performed based on the last image logging conditions executed.

Logging Conditions (Image Logging)

Indicate the image to perform logging for. If 4 cameras are connected, image logging is performed for 4 cameras each time.

- Tap [Logging condition] in the Item Tab area.
- Set the logging conditions.

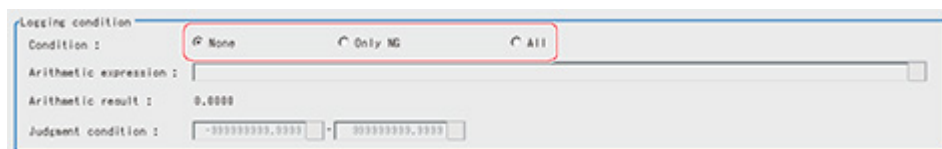

Setting item	Set value [Factory default]	Description
Logging condition	• [None]	No images are saved.
	• Only NG	Saves images only if an NG occurs. If an NG occurs downstream from the image logging processing unit, image logging is not performed. Insert image logging as close to the end of the scene as possible
	• All	All measured images are saved.

- When "Only NG" is selected, tap [...].

The Setting Expression window is displayed.

- Logging conditions are set using an expression.
Reference: ▶ Layout of Setting Expression Window (p.343)
- After setting up the expression, tap [OK].
The expression is confirmed.
- Set up the judgement upper limit and the judgement lower limit for "Judgement condition".

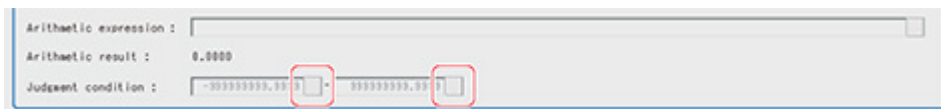

Setting item	Set value [Factory default]	Description
Judgment condition	-999999999.9999 to 999999999.9999	This is a judgement condition for the expression. Set upper and lower limits for judging as OK.

Save Destination (Image Logging)

- Set the logging images save destination.
Enabled when "Save to memory + file" is selected as the save destination in the system image logging settings.

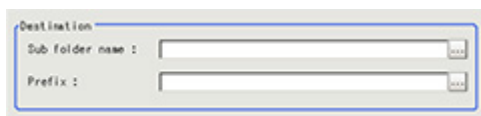

Setting item	Setting value [Factory default]	Description
Sub folder name	-	Designates sub folder names. Creates a sub folder in the save destination in system logging settings. The following characters cannot be used for designating a file name. \\ : * ? " < >
Prefix	-	Sets the prefix for the save file name. The set character string is added at the beginning of the name of the save file. If the system logging settings designate a prefix, the file name is set to [prefix designated by image logging] + [prefix designated by system logging settings] + image logging file name.

- Set the File count in folder, if necessary.

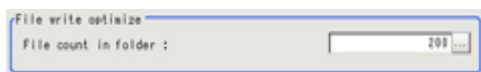

Setting item	Setting value [Factory default]	Description
File count in folder	0 to 1000[200]	Set the maximum number of files that can be saved in 1 folder. The name of the folder to be automatically generated will be the same as that of the first image logging file to be stored in that folder. Furthermore, if 0 is specified, folders are not automatically generated.

Reference

- If too many files are saved in 1 folder, performance may drop. Performance drop can be prevented by setting [File count in folder].

Important

- If conditional branching is used, the number of files saved may vary from the specified number.
- If the operation mode is [Single-line High-speed mode], images taken by odd-numbered measurements are stored in a file different from one containing images taken by even-numbered measurements.
- If the operation mode is [Non-stop adjustment mode], the number of files in the folder may vary from the specified number before and after non-stop adjustment.

Key Points for Test Measurement and Adjustment (Image Logging)

The following content can be confirmed in the "Detail result" area using text.

Displayed items	Description
Judge	Judgement result
Expression	Calculation result of conditional expression

Measurement Results for Which Output Is Possible (Image Logging)

The following values can be output using processing items related to results output. It is also possible to reference measurement values from expressions and other processing units.

Measurement items	Character string	Description
Judgement	JG	Judgement result
Data	D00	Conditional expression data
Judge	J00	Conditional expression judgement

Data Logging

This is used to save measurement data in storage or USB memory.

Used in the Following Case

- When performing analysis using measurement data

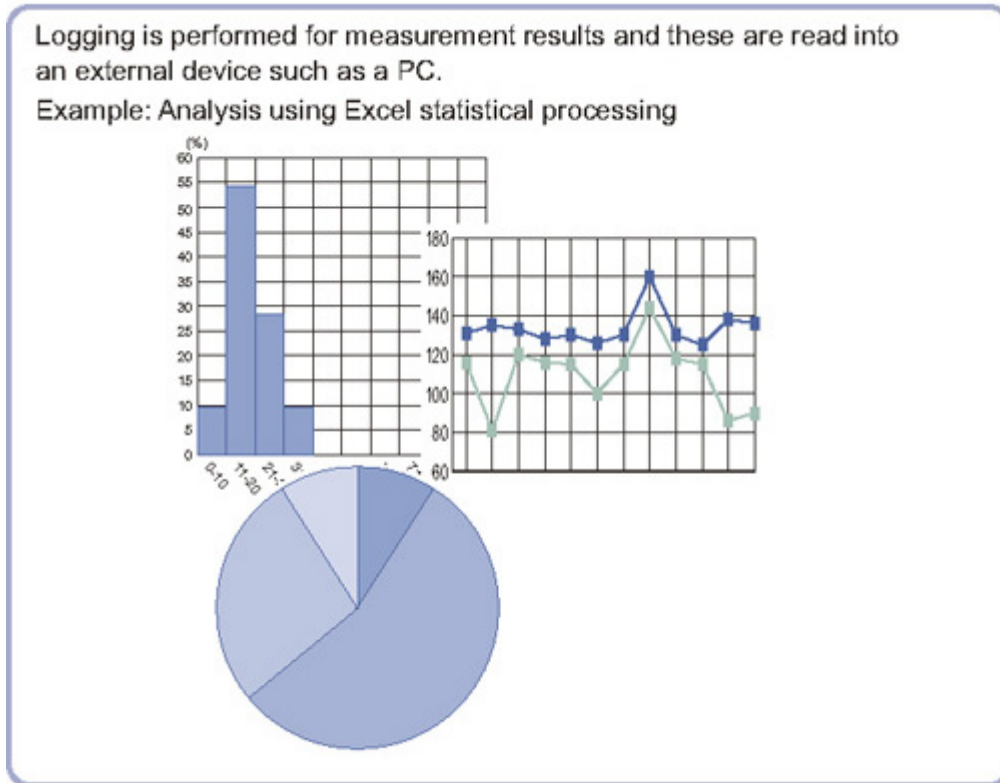

Important

- Insert data logging as close to the end of the flow as possible. If "Only NG" is selected in logging timing conditions and an NG occurs after the data logging processing unit, it will not be logged.
- Setting data logging settings to save [Image logging] makes simultaneous confirmation of measurement data and image data convenient.

Reference: ▶ "User's Manual", "Setting Logging Conditions [Logging setting]" (p.98)

Settings (Data Logging)

Indicate the data to perform logging for. Logging can be performed for up to 8 data using one "Data logging" processing item.

Note

- If you want to perform logging for 9 or more data using one record

Reference: ▶ Additional Explanation (Data Logging) (p.394)

1. In the Item Tab area, tap [Setting].

- In the list, tap the output No. for which the expression is to be set.

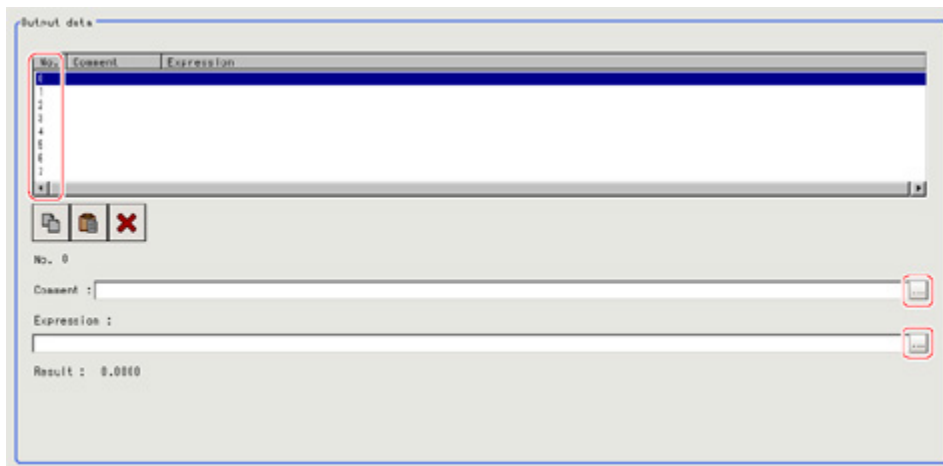

The selected output No. is displayed under the list.

- Tap [...] for the Exp.
The Setting Expression window is displayed.
- Logging target data is set up using an expression.
Reference: ▶ Layout of Setting Expression Window (p.343)
- Input "Comment" as necessary.
- Repeat steps Reference: ▶ 2(p.392) to Reference: ▶ 5(p.392) and set up the output contents for each output number.

Output Format (Data Logging)

Sets the output format for logging data.

- In the Item Tab area, tap [Output format].
- Set up each item as necessary.

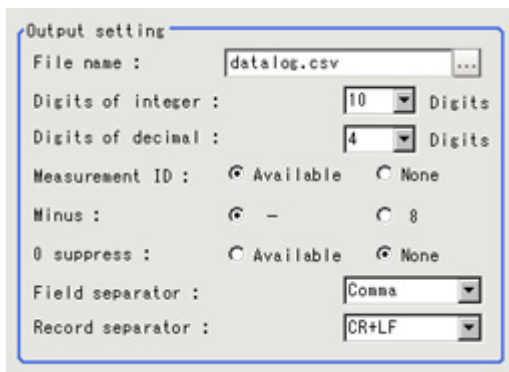

Setting item	Set value [Factory default]	Description
File name	datalog.csv	Half-width alphanumeric characters are used for File name. (Max: 128 characters) Set the folder name and file name such that they are no more than 255 characters combined.

Digits of Integer	1 to [10]	Specify the digits of the integer part including the sign. For positive numbers, the plus sign is not output. Example Setting: 4 digits, Data: -5619 -999 is output.
Digits of Decimal	0 to [4]	Specify the number of output digits in the decimal part. Decimals are rounded up and output. When 0 is selected, the decimal digits will be rounded off.
Measurement ID	<ul style="list-style-type: none"> • [Available] • None 	Select whether to output the measurement ID at the head of the output data. Measurement ID : measurement time YYYY-MM-DD_HH-MM-SS-MS (YYYY: Calendar, MM: Month, DD: Day, HH: Hour, MM: Minute, SS: Second, MS: millisecond) Example Measurement time: 11:10:25.500 AM, December 24, 2007, the measurement ID is "2007-12-24_11-10-25-500". Since the file name of the logging image also includes the same measurement ID, confirmation of the measurement data and image data can be performed with the measurement ID.
Minus	<ul style="list-style-type: none"> • [-] • 8 	Select what is displayed in the sign column for a negative number.
0 suppress	<ul style="list-style-type: none"> • Available • [None] 	Select the method for adjusting when there is a blank to the left of the output data. Available: Insert 0 into the blank digit space. None: Insert a space in the location with no character. Example When integer section setting: 5 digits, decimal section setting: 3 digits, data is 100.000 Available: 00100.000 None: _100.000 (_ represents a space)
Field separator	<ul style="list-style-type: none"> • OFF • [Comma] • Tab • Space • CR+LF 	Select the separator for output data.
Record separator	<ul style="list-style-type: none"> • OFF • Comma • Tab • Space • [CR+LF] 	Select the separator each time data is output.

Note

- The actual data output is in the ASCII format with the following type of header added.

Measurement ID,Data1 Data N + delimiter

Measurement time : YYYY-MM-DD_HH-MM-SS-

(YYYY: Calendar, MM: Month, DD: Day, HH: Hour, MM: Minute, SS: Second, MS: millisecond)

Example)

Measurement time: 11:10:25.500 AM, December 24, 2007

Measurement ID is "2007-12-24_11-10-25-500".

- Logging timing and saving destination
Reference: ▶ "User's Manual" "Logging Measurement Values and Measurement Images" (p.96)

Additional Explanation (Data Logging)

When 9 or More Data Items Are Output as One Record

Up to 8 Value can be output with one [Data Logging] Processing Item. When 9 or more data items are to be output as 1 record, perform settings in the following manner.

- Registers two or more [Data Logging] units in one scene.(*1)
- Set [File name] of [Data Logging] so that it is identical.(*2)
- This prepares set up to attach "Record separator (CR+LF)" to the end of all data output.(*3)

Example) When outputting the coordinate data for 12 points acquired in two "Search" of measurements performed on substrate arrangement in 1 record.

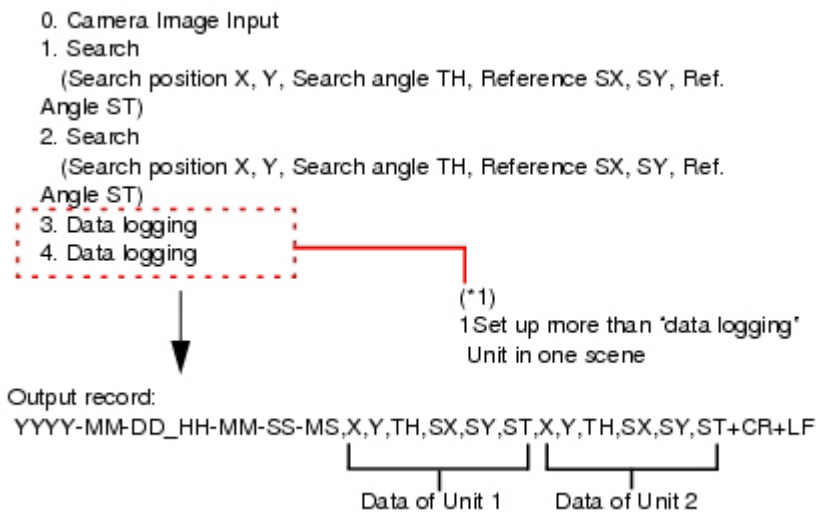

Unit 3 [Data logging] setting details		Unit 4 [Data logging] setting details		Remarks
<Condition setting>		<Condition setting>		
Output Destination (File name)	datalog.csv	Output Destination (File name)	datalog.csv	(*2) Make the path and file name the same.
Integer	8	Integer	8	
Decimal	3	Decimal	3	
Measurement ID	ON	Measurement ID	ON	
Minus	-	Minus	-	
0 suppress	OFF	0 suppress	OFF	
Field separator	Comma	Field separator	Comma	
Record separator	Comma	Record separator	CR+LF	(*3) Set "Record separator (CR+LF)" in unit 4 which contains the last data
<Output data>		<Output data>		

Calculation 0. U1.X (Search position X) Calculation 1. U1.Y (Search position Y) Calculation 2. U1.TH (Angle θ) Calculation 3. U1.SX (reference X) Calculation 4. U1.SX (reference Y) Calculation 5. U1.ST (Reference angle) Calculation 6. U2.X (Search position X) Calculation 7. U2.Y (Search position Y)	Calculation 0. U2.TH (Search angle θ) Calculation 1. U2.SX (reference X) Calculation 2. U2.SY (reference Y) Calculation 3. U2.ST (Reference angle θ)	The data not included in Unit 3 will be output as Calculation 0 to 3 in Unit 4
--	---	--

Measurement Results for Which Output Is Possible (Data Logging)

The following values can be output using processing items related to results output. It is also possible to reference measurement values from expressions and other processing units.

Measurement item	Character string	Description
Judgement	JG	Judgement result
Result of Expression 0 - Result of Expression 7	D00 to D07	Expression result of expression 0 to Expression result of expression 7

Elapsed Time

Calculate the elapsed time in milliseconds after the measurement starts. You can add this processing item to a scene and setup is not required.

Used in the Following Case

- When combining with the conditional branch for stopping measurement after the specified processing time has elapsed.

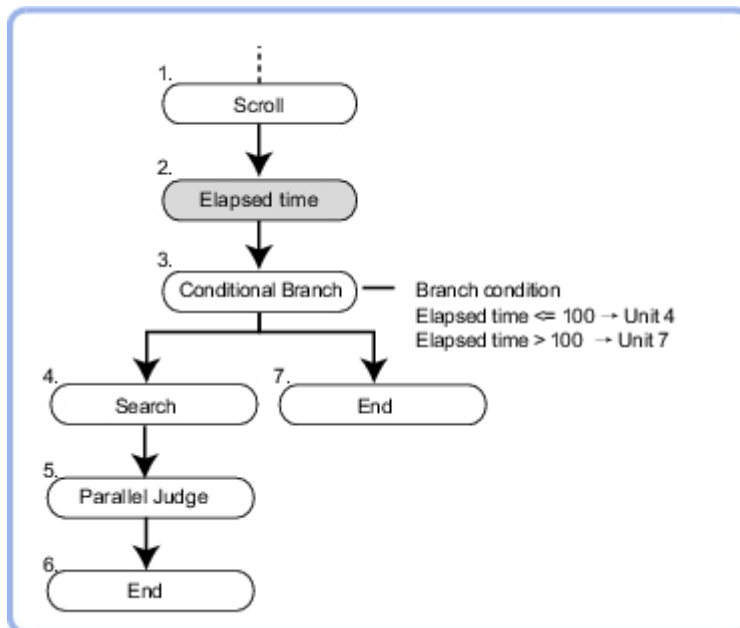

- When calculating the processing execution time of a unit

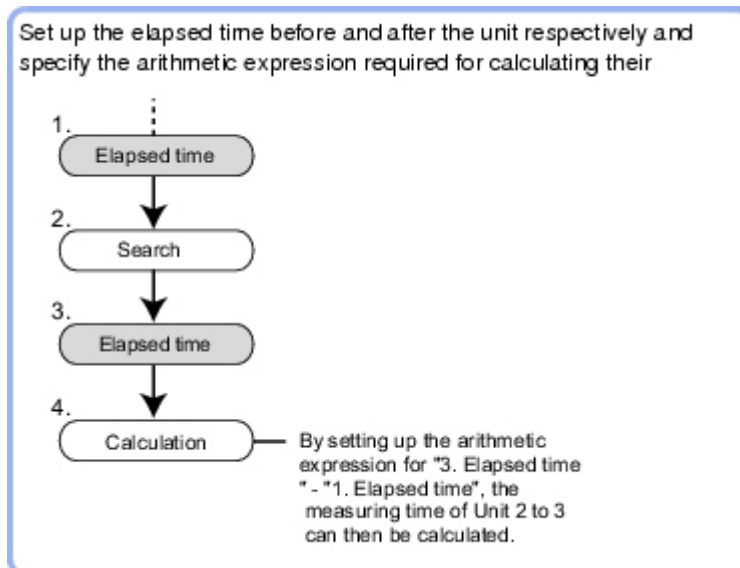

Note

- Time elapse can be confirmed on the main screen "Detail result" area.



Measurement Results for Which Output Is Possible (Elapsed Time)

The following values can be output using processing items related to results output. It is also possible to reference measurement values from expressions and other processing units.

Measurement items	Character string	Description
Judge	JG	Latest processing unit judgement result
Elapsed Time	TM	Elapsed time from start of measurement (ms)

Wait

Used in the Following Case

- When pausing the measurement flow and setting processing in standby for a specific period of time

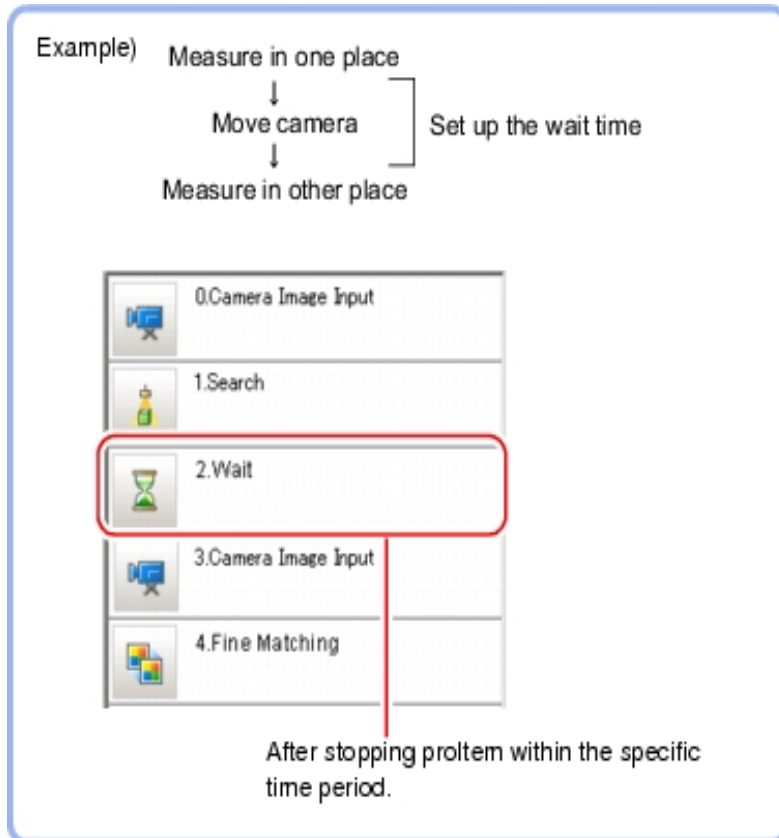

Settings (Wait)

- Set the temporary stop time for flow in the "Waiting time" area.

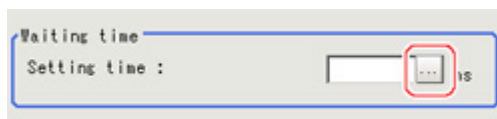

Please specify the time in ms.
This can be set to a range of 0 to 9999.

- Tap [OK].
The settings are finalized.

Focus

This function helps you to bring the camera into focus.

Used in the Following Case

- Use this function to make adjustments so as to facilitate inspection of input images that tend to become out of focus.

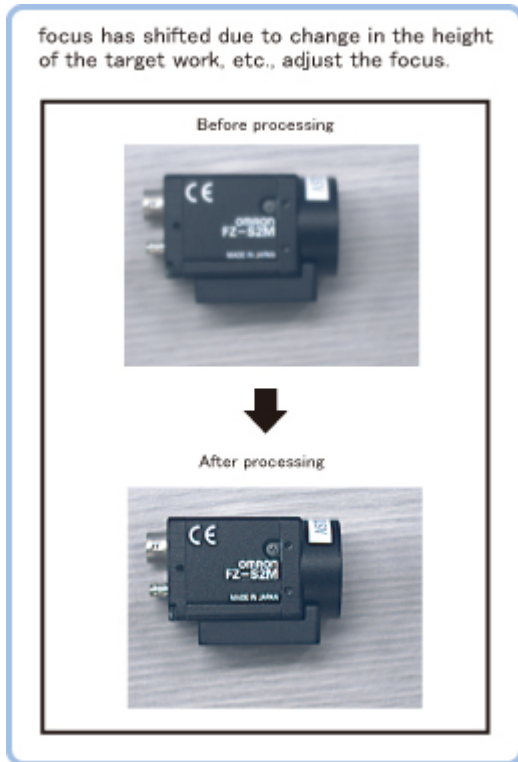

Measurement Parameters (Focus)

Measurement parameters can be changed as needed to address unstable focus values.

- In the item tab area, tap [Measurement].
- In the "Display" area, tap [Change display] to switch between camera image types. (Re-measurement images are not shown on the setting window.)

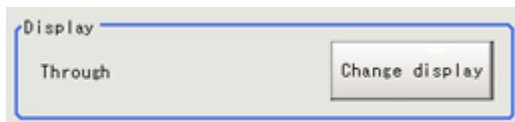

Setting item	Setting value	Description
ON	Through	The latest image is always input from the camera and displayed.
	Freeze	The image that was scanned in the immediately preceding measurement is displayed.

- Set the focus value.
The focus value is displayed chronologically in real time in the graph area.

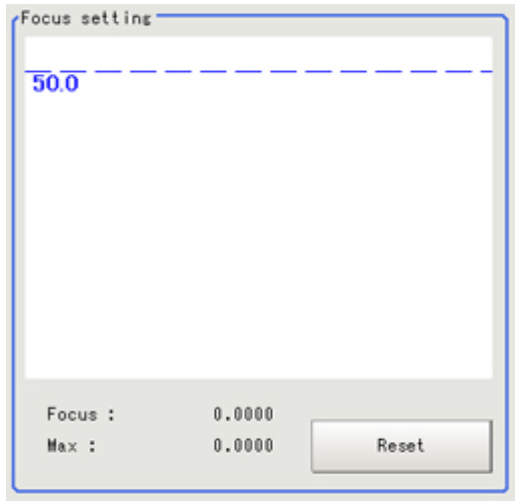

4. Set up the judgement condition.



Setting item	Setting value [Factory default]	Description
Focus	0.0000 to 255.0000 [50.0000]	This item specifies the judgement value for focus.

Region Setting (Focus)

Set the range of focus adjustment.

1. In the item tab area, tap [Region setting].
2. Tap [Edit].



The figure setting area is displayed.

3. Specify the range of focus adjustment.
The rectangle covering the entire screen is set. Adjust the size and position of the rectangle.
4. Tap [OK].
The range to adjust is registered.

Output Parameters (Focus)

Specifies whether or not the judgement results of this processing unit is reflected in the scene overall judgement.

1. Tap [Output parameter] in the item tab area.
2. Choose whether or not to reflect this in the scene overall judgement in "Reflect to overall judgement" area.



Setting item	Setting value [Factory default]	Description
Reflect to overall judgement	<ul style="list-style-type: none"> • [ON] • OFF 	Enables choosing whether or not the judgement results of this processing unit is reflected in the scene overall judgement.

Key Points for Test Measurement and Adjustment (Focus)

Displayed items	Description
Judge	Judgement result
Focus	Focus value

Iris

This function assists the aperture operation to adjust the amount of light taken in by the camera according to the change in illumination intensity.

Used in the Following Case

- When brightness at the measurement site changes:

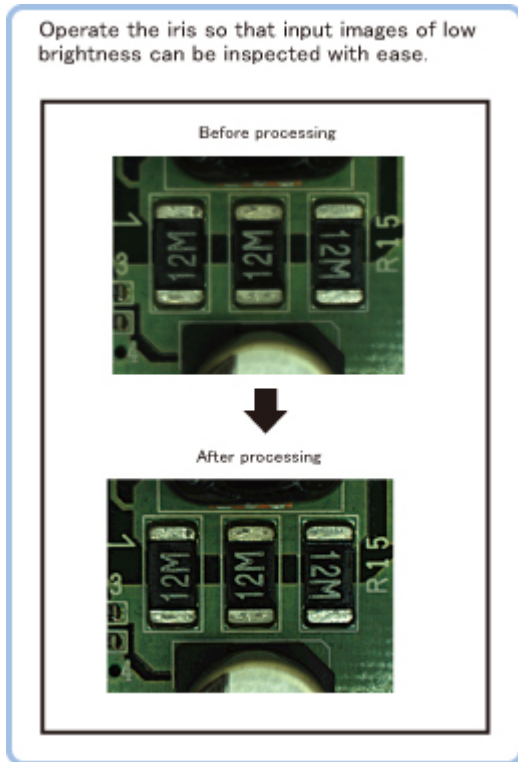

Measurement Parameters (Iris)

Adjust the amount of light taken in through the lens. Change the measurement parameter as necessary.

1. In the item tab area, tap [Measurement].
2. In the "Display" area, tap [Change display] to switch between camera image types.

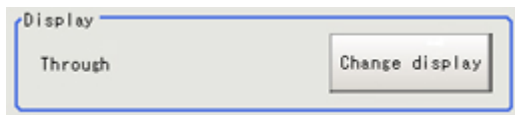

Setting item	Setting value	Description
ON	Through	The latest image is always input from the camera and displayed.
	Freeze	The image that was scanned in the immediately preceding measurement is displayed.

3. Set the valid brightness range.
The valid pixels are displayed chronologically in real time in the graph area.

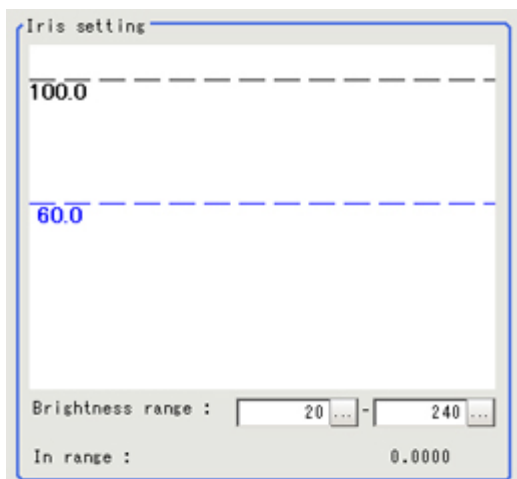

Setting item		Setting value [Factory default]	Description
Brightness range	Upper limit	0 to 255 [240]	Set the range used to determine whether or not the brightness of pixels is valid.
	Lower limit	0 to 255 [20]	

4. Set up the judgement condition.

For color cameras:

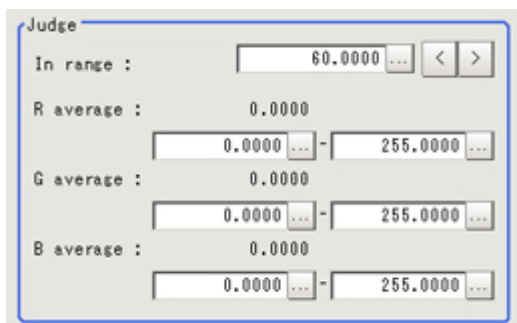

Setting item		Setting value [Factory default]	Description
In range		0.0000 to 100.0000 [60.0000]	Set the minimum number of pixels to be made valid. Valid pixels indicate the percentage (%) of pixels inside the valid brightness range in the region.
R average	Upper limit	0 to 255 [255.000]	Set the R, G and B ranges to be made valid.
	Lower limit	0 to 255 [0.000]	
G average	Upper limit	0 to 255 [255.000]	
	Lower limit	0 to 255 [0.000]	
B average	Upper limit	0 to 255 [255.000]	
	Lower limit	0 to 255 [0.000]	

For monochrome cameras:

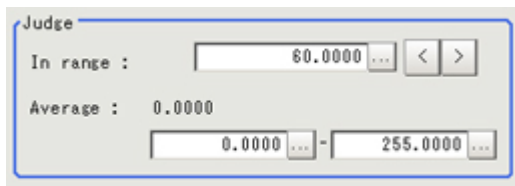

Setting item		Setting value [Factory default]	Description
In range		0.0000 to 100.0000 [60.0000]	Set the minimum number of pixels to be made valid. Valid pixels indicate the percentage (%) of pixels inside the valid brightness range in the region.
Average	Upper limit	0 to 255 [255.000]	Set the average brightness range to be made valid.
	Lower limit	0 to 255 [0.000]	

Region Setting (Iris)

Set the range of iris adjustment.

1. In the item tab area, tap [Region setting].
2. Tap [Edit].



The figure setting area is displayed.

3. Specify the range of iris adjustment.

- The rectangle covering the entire screen is set. Adjust the size and position of the rectangle.
4. Tap [OK].
The range to adjust is registered.

Output Parameter (Iris)

Specifies whether or not the judgement results of this processing unit is reflected in the scene overall judgement.

1. Tap [Output parameter] in the item tab area.
2. Choose whether or not to reflect this in the scene overall judgement in "Reflect to overall judgement" area.



Setting item	Setting value [Factory default]	Description
Reflect to overall judgement	<ul style="list-style-type: none"> • [ON] • OFF 	Enables choosing whether or not the judgement results of this processing unit is reflected in the scene overall judgement.

Key Points for Test Measurement and Adjustment (Iris)

Displayed items	Description
Judge	Judgement result
In range	Percentage inside the valid brightness range
R average	R average in the region
G average	G average in the region
B average	B average in the region

Branch

This chapter describes setting methods for when branch processing is performed.

- ▶ Reference: Conditional Branch (p.408)
- ▶ Reference: End (p.413)
- ▶ Reference: DI Branch (p.415)

Conditional Branch

Expressions and conditions are set, and processing after this processing item is divided into two according to the comparison calculation.

Used in the Following Case

- When two more types of products are on the production line and inspection is to be performed separately for each

Example) Detect the printing quality of candy boxes.

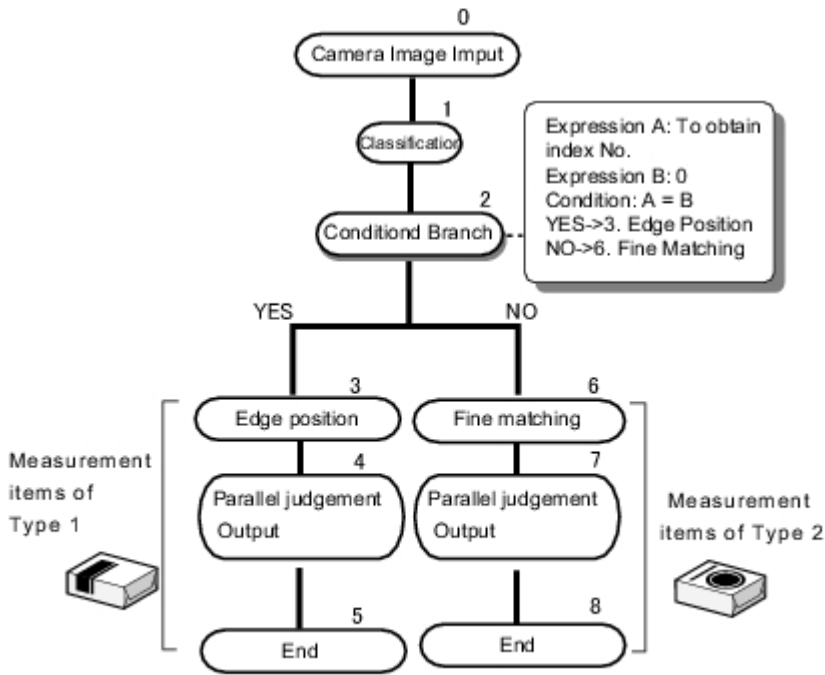
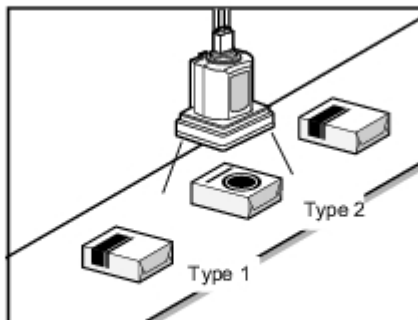

List of Conditional Branch Items

Set	Description	Set value [factory default]
Condition	Select the method to compare expression A and B. Compare two data items that are obtained through conditional expressions.	<ul style="list-style-type: none"> • [A=B] • A<=B • A<B • A>=B • A>B
Expression A	Set the evaluation expression that is to be the basis for branching. Set the expression through calculation. Reference: ▶ Settings (Calculation) (p.340)	Up to 256 characters
Expression B		
Destination unit	YES	Select the destination unit number for when the result of the comparison is true.
	NO	Select the destination unit number for when the result of the comparison is false.

Conditional Branch

Specify expression A and B for the branching conditions.

1. Set expression A and B separately.

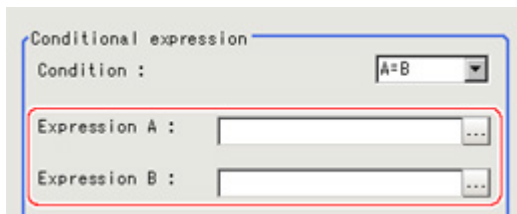

Reference: ▶ Layout of Setting Expression Window (p.343)

2. Tap [▼] in "Condition" to set conditions.

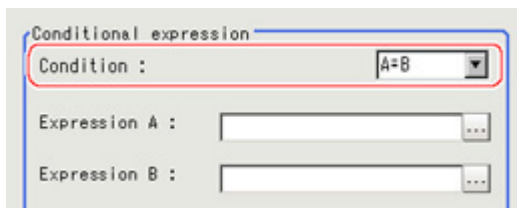

Condition	Description
A=B	If the value from expression A is equal to that from expression B, moves to the unit in which "Destination unit" is YES. If not, moves to the NO unit.
A<=B	If the value from expression A is equal to that of expression B, or if the value of A is lower than that of B, moves to the unit in which "Destination unit" is "YES". If A is larger, moves to the unit with "NO".

A<B	If the value from expression A is lower than the value from expression B, moves to the unit in which "Destination unit" is YES. If A is equal to or greater than B, moves to the NO unit.
A>=B	If the value from expression A is equal to that of expression B, or if the value of A is higher than that of B, moves to the unit in which "Destination unit" is "YES". If B is higher, moves to the unit with "NO".
A>B	If the value from expression A is higher than the value from expression B, moves to the unit in which "Destination unit" is YES. If A is equal to or less than B, moves to the NO unit.

3. Set the branch destination.

Important

- In order to avoid measurement processing looping, for the branch destination, set a processing unit number that is after the [Conditional Branch].
- Make sure to set "End" at the last branch destination to indicate the end of the branch.
Reference: ▶ End (p.413)

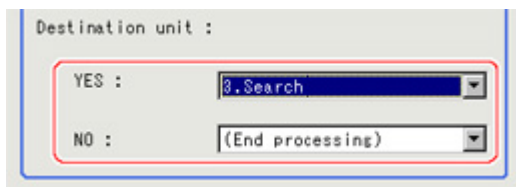

Note

- The judgement result for a processing unit is finalized when that processing unit is processed.
- The overall judgement is finalized when all processing unit measurement is complete.

Conditional Branch Settings Examples

The overall judgement result for processing up to the unit number in which the expression is set is acquired and subsequent measurement is branched according the result.

For example, condition branching is performed based on the overall judgement result of Units 0 to 4.

Sample Display

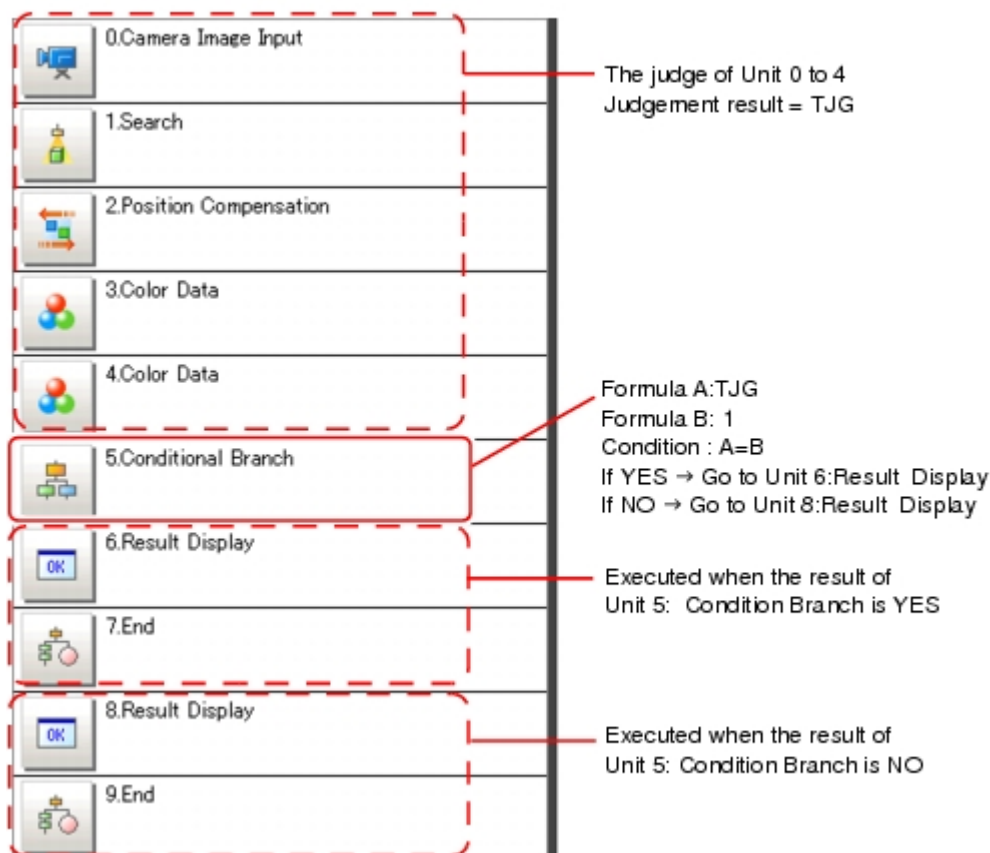

1. Set [Conditional Branch] in Unit 5. Set the following expressions in Expression A and B, respectively.

- Expression A: TJG

Acquire the overall judgement results from Unit 0 to Unit 4. The overall results based on the judgement results of Unit 0 to Unit 4 are output in the following manner.

Result of unit 0 to unit 4	TJG output
All the unit's judgement results are OK	1
The judgement results of one or more units are NG	-1

- Expression B: 1

Set the value that will be compared with the value of A (TJG value).

2. Set the condition of the conditional expression to "A = B".

A = B, which means that TJG = 1, is set as the condition. As a result, if all the unit judgement results from 0 to 4 are OK, then the condition judgement result will be "YES".

3. Set each of the Conditional Branch destinations.

If "Yes", branch to unit 6. If "No", branch to unit 8.

Important

- Parameters for units that do not pass through a conditional branchThe measurement results other than the unit judgement result (JG) retain the measurement results from the previous time the unit passed through the conditional branch. The JG for units that do not pass through the condition branch becomes unmeasured (0).

Note, however, that the unit JG becomes unmeasured at the point in time when all the measurement processing ends. During flow processing, the previous time judgement (JG) is retained.

Measurement Results for Which Output Is Possible (Conditional Branch)

The following values can be output using processing items related to results output. It is also possible to reference measurement values from expressions and other processing units.

Measurement items	Character string	Description
Judgement	JG	Judgement result
Expression A result	D0	Operational result of expression selected in expression A
Expression B result	D1	Operational result of expression selected in expression B
Comparison result	RS	Result from comparing the expressions (0: NO, 1: YES)
Destination unit No.	BU	Unit No. at destination based on the compares results of expressions

End

This processing item only needs to be added to the scene. Operations such as condition setting are unnecessary.
Please set at the last unit of each branch.

Used in the Following Case

- When finishing the last Processing Item of a branch

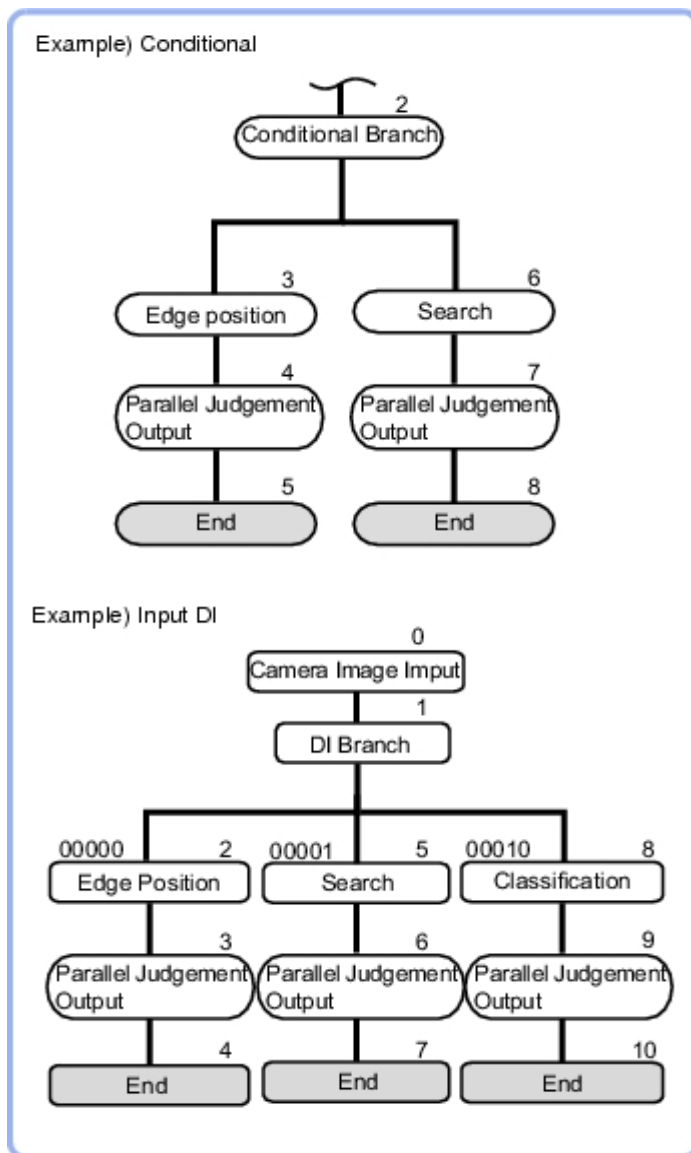

Note

- If [End] is not set at the end of a branch, the processing in the scene will continue to move to the next unit No. even if the branch has been completed.

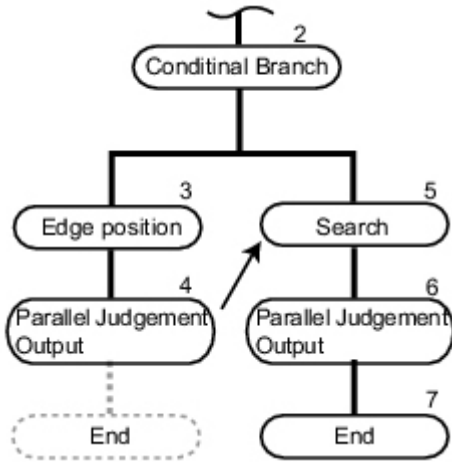

DI Branch

Starting from this processing item, processing is branched according to the information input to terminal blocks D10 to D14. Up to 32 branch destinations can be set.

Used in the Following Case

- When products on one production line are to be inspected according to a time interval

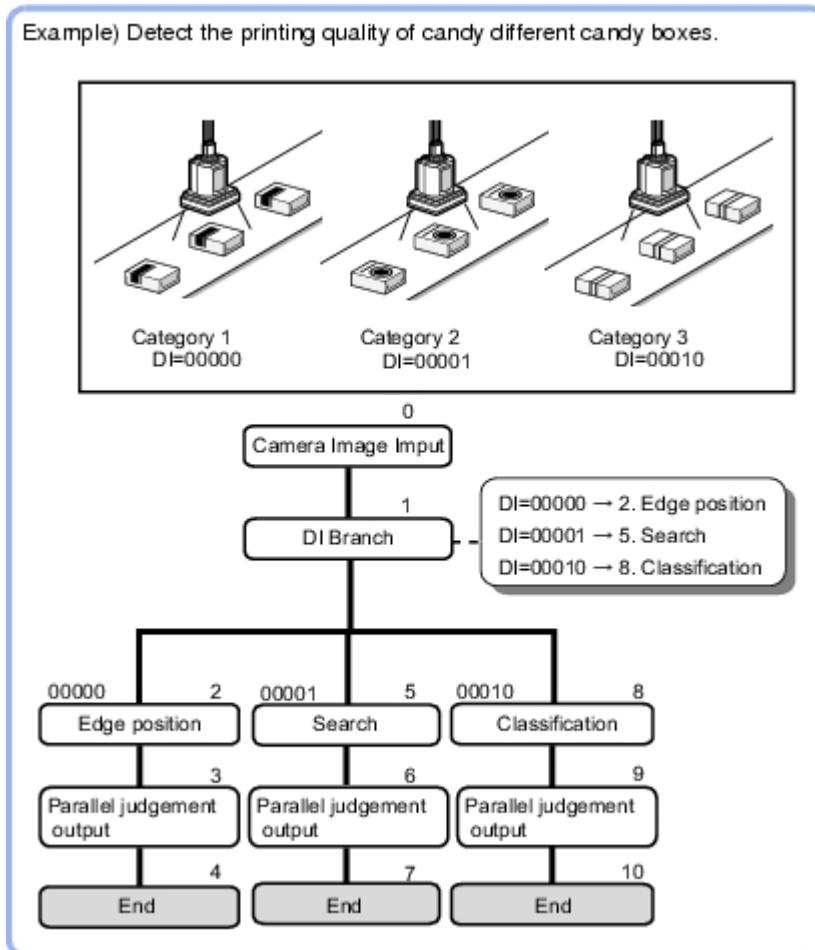

Settings (DI Branch)

Select the destination unit. Perform settings according to the information input in DI.

- In the item tab area, tap [Setting].

2. Tap the DI input from the input signal list for which the branch destination is to be set up.

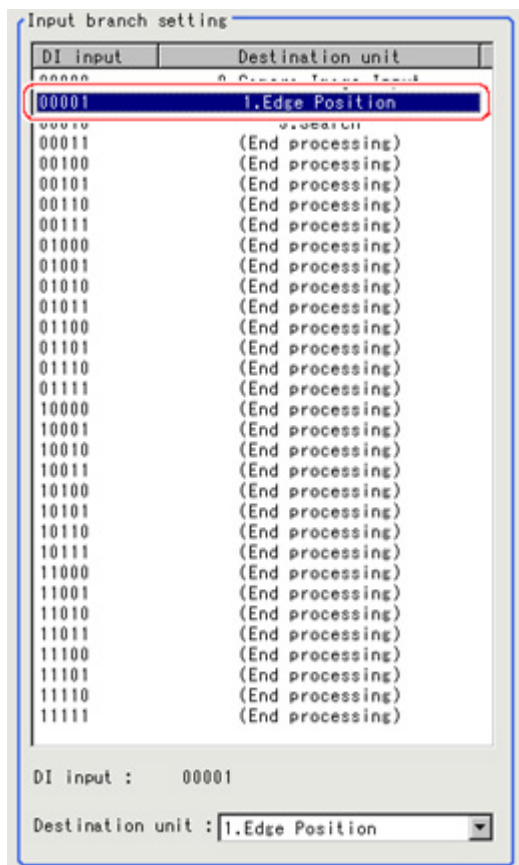

3. At "Destination unit", tap [▼] and set the destination unit.

Important

- In order to avoid measurement processing looping, for the branch destination, set a processing unit number that is after the [DI Branch].
- Make sure to set "End" at the last branch destination to indicate the end of the branch.
Reference: ▶ Measurement Completion (p.413)
- If the operation mode (FZ3-9 □□ /H9 □□ only) is set to [Multi-line random-trigger mode], DI inputs are handled differently as follows.
Line 0: Conform to the statuses of DI0 and 1 inputs.
Line 1: Conform to the statuses of DI2 and 3 inputs.

4. Repeat the steps Reference: ▶ 2(p.416) to Reference: ▶ 3(p.416) and set the destination units for other input signals.

Note

- Up to 32 (0 to 31) branch destinations can be set.
- The controller references the DI signal when the [DI Branch] measurement is executed.

5. Tap [OK].

The settings are finalized.

Measurement Results for Which Output Is Possible (DI Branch)

The following values can be output using processing items related to results output. It is also possible to reference measurement values from expressions and other processing units.

Measurement items	Character string	Description
Judgement	JG	Judgement result
DI input No.	DI	No. used to indicate DI input (00000 to 11111)
Unit No	BU	Unit number at destination corresponding to DI input

Output result

This chapter describes setting methods for when measurement results are output to the external devices.

- ▶ Reference: Data Output (p.420)
- ▶ Reference: Parallel Data Output (p.425)
- ▶ Reference: Parallel Judgement Output (p.428)
- ▶ Reference: Fieldbus Data Output (p.431)

Data Output

Used in the Following Case

- Output data to the external devices such as programmable controller and PC with the no-order mode via the serial interface. With serial data output, output starts immediately after the end of processing of serial data output in the flow.

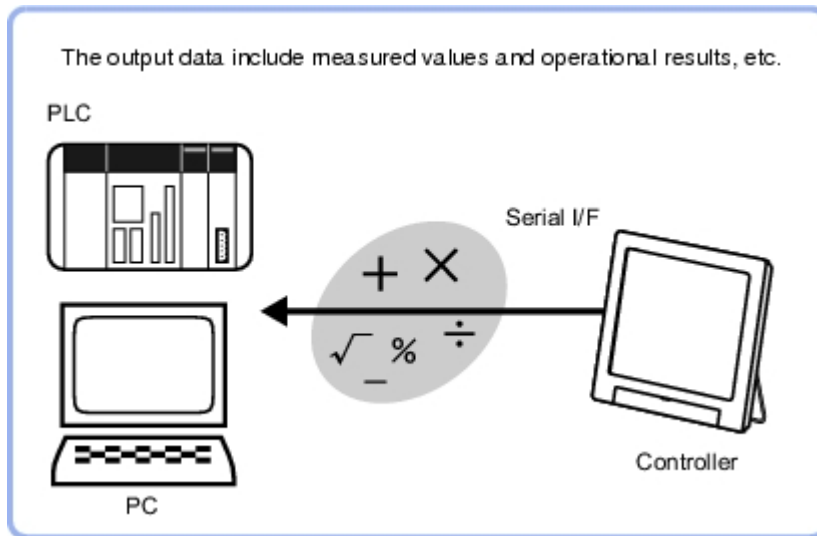

Important

- When performing measurements in the ADJUST window, the values are only output when external output is enabled by the following method.
 - In the Control area, check "Output" in [Test measurement].When the measurement is executed in the RUN window, output is executed regardless of the external output setting.

Settings (Data Output)

Set up the output contents with the expression.

Up to 8 expressions including 0 to 7 can be set in each unit.

1. In the Item Tab area, tap [Setting].
2. In the list, tap the output No. for which the expression is to be set.

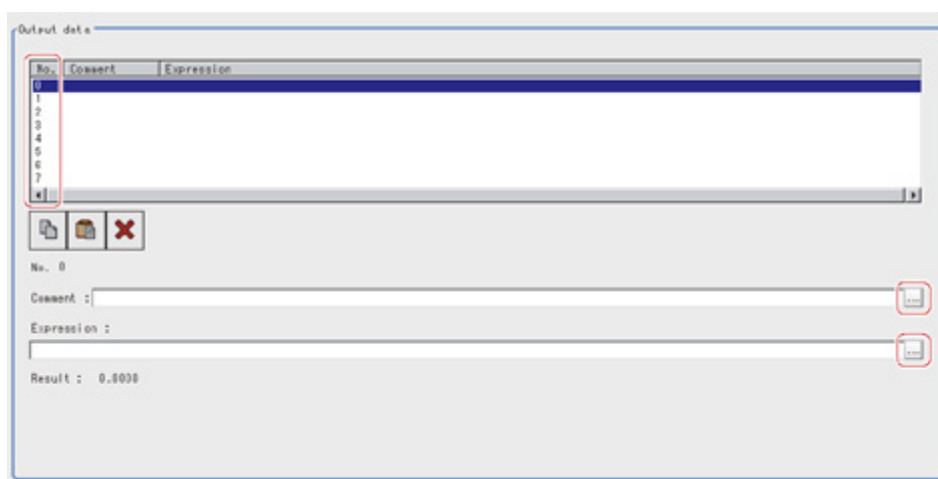

- The selected output No. is displayed under the list.
3. Tap [...] for the expression and set the expression.
 4. If necessary, input an explanation of the expression in "Comment".
 5. Repeat steps Reference: ▶ 2(p.420) to Reference: ▶ 5(p.421) and set up the output contents for each output number.

Output Format (Data Output)

1. In the item tab area, tap [Output format].
2. In the "Output setting" area, select the communication method.

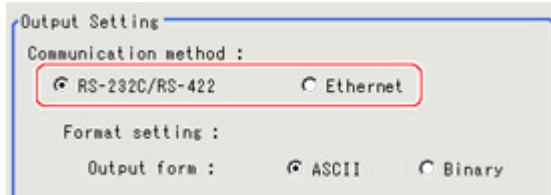

Setting value [Factory default]	Description
[RS-232C/RS-422]	Communication is performed via a RS-232C/RS-422 connection.
Ethernet	Communication is performed via the Ethernet.

3. In "Format setting", select the output format.

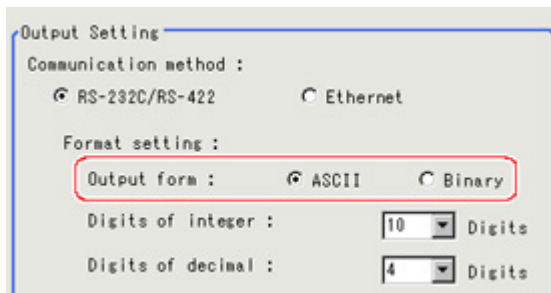

Setting value [Factory default]	Description
[ASCII]	Outputs in the ASCII format. Reference: ▶ "User's Manual", "Character Code Table" (p.364)
Binary	Outputs as binary data. Measurement values are multiplied by 1,000 and output is continuous with 4 bytes per each data item.

When the "ASCII" output format is selected:

When "ASCII" is set as the output format, set the following items among the format settings.
When "Binary" is set as the Decimal output form, no setting is needed.

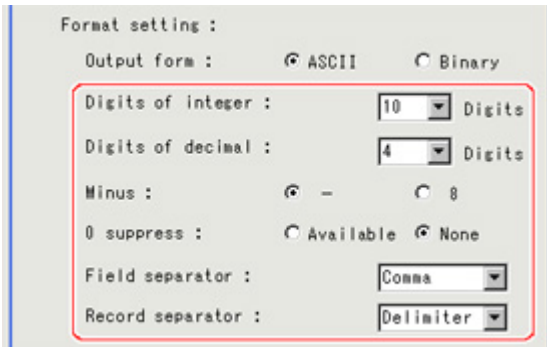

Setting item	Setting value [Factory default]	Description
Digits of integer	1 to [10]	Specify the digits of the integer part including the sign. For positive numbers, the plus sign is not output. Example Setting: 4 digits, Data: -5619 -999 is output.
Digits of decimal	0 to [4]	Specify the number of output digits in the decimal part. Decimals are rounded up and output. When 0 is selected, the decimal digits will be rounded off.
Minus	<ul style="list-style-type: none"> • [-] • 8 	Select what is displayed in the sign column for a negative number.
0 suppress	<ul style="list-style-type: none"> • ON • [OFF] 	Select the method for adjusting when there is a blank to the left of the output data. ON: Insert 0 into the blank digit space. OFF: Insert a space in the location with no character. Example Digits of integer: 5 places, Digits of decimal: 3 places. When data is 100.000 ON: 00100.000 OFF: _100.000 (_ represents a space)
Field separator	<ul style="list-style-type: none"> • OFF • [Comma] • Tab • Space • Delimiter 	Select the separator for output data. *The delimiter is obtained from the system.
Record separator	<ul style="list-style-type: none"> • OFF • Comma • Tab • Space • [Delimiter] 	Select the separator each time data is output. *The delimiter is obtained from the system.

4. If you have selected "Ethernet" for "Communication method", perform Ethernet settings.

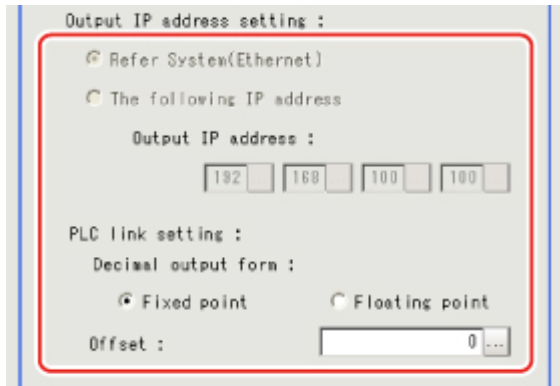

Setting value [Factory default]	Description	
[Refer System (system -comm -Ethernet)]	The settings of the Ethernet window are applied. Reference: ▶ "User's Manual", "Setting Communication Specifications (Ethernet - PLC Link)" (p.159) Reference: ▶ "User's Manual", "Setting Communication Specifications (Ethernet - Non-procedure)" (p.186)	
The following IP address		
	Output IP address	Enter the Output IP address.
PLC Link setting	Specify the Decimal output form for the PLC link. When precision to 4 digits after the decimal point is required, use a Floating point.	
Decimal output form		
	Fixed point	Data is output multiplied by 1,000. Example: For 123.456, 0x0001E240
	Floating point	Data is output in floating point format. Example: For -123.4567, 0xc2f6e979
Setting item	Setting value [Factory default]	Description
Offset	[0] to 99999	Set the number of offset channels in the output area.

Important

About output when Ethernet is set as the output destination

- Output format: ASCII
1 packet is output for each 1 unit of serial data output.
When multiple units of serial data are output, that many packets are output.
- Output format: binary
1 packet is output for each 1 data item of serial data output.

Set an appropriate offset value according to the maximum value of write address for the PLC. If a value exceeding the maximum value permitted by the PLC is set, an error occurs.

Key Points for Test Measurement and Adjustment (Data Output)

The following content can be confirmed in the "Detail result" area using text.

Displayed items	Description
Judge	Judgement result
Expression0-7	Results of expressions 0 - 7

Measurement Results for Which Output Is Possible (Data Output)

The following values can be output using processing items related to results output. It is also possible to reference measurement values from expressions and other processing units.

Measurement item	Character string	Description
Judgement	JG	Judgement result
Data 0 to 7	D00 to D07	Results of expressions set for output data 0 to 7

Parallel Data Output

Used in the Following Case

- Used when outputting data to external devices such as a programmable controller or a PC via the parallel interface.

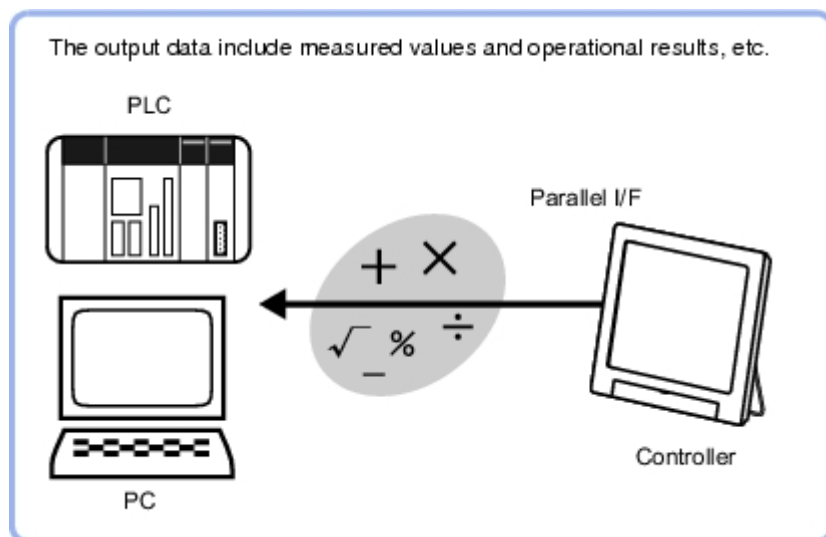

Important

- When performing measurements in the ADJUST window, the values are only output when external output is enabled by the following method during the measurement.
 - In the Control area, check "Output" in [Test measurement].When the measurement is executed in the RUN window, output is executed regardless of the external output setting.
- Even if this processing item is not set up in the scene, the overall judgement for the set processing items is still output via the OR signal from the parallel interface.

Settings (Parallel Data Output)

Set up the output contents with the expression.

Up to 8 expressions including 0 to 7 can be set in each unit.

- In the Item Tab area, tap [Setting].

- In the list, tap the output No. for which the expression is to be set.

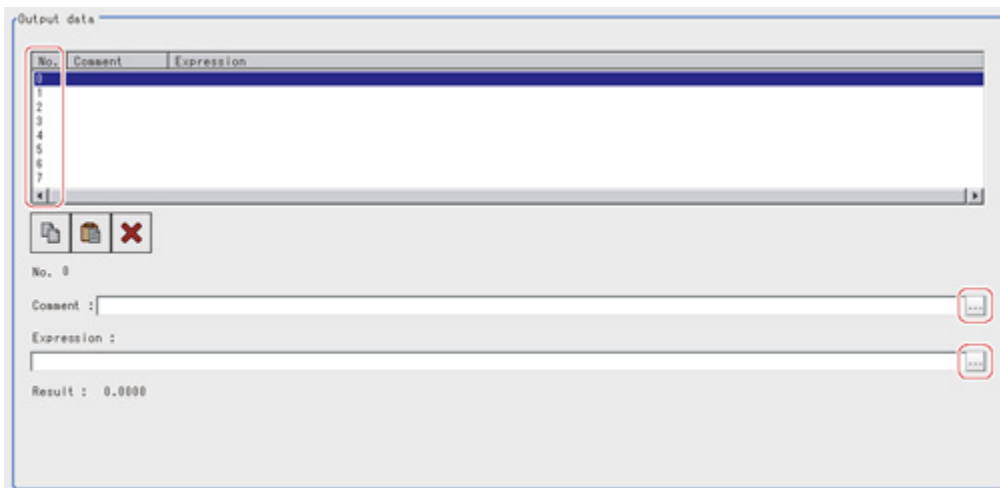

The selected output No. is displayed under the list.

- Tap [...] for the expression and set the expression.
Reference: ▶ Layout of Setting Expression Window (p.343)
- Input an explanation of the expression in "Comment" as necessary.
- Repeat steps Reference: ▶ 2(p.426) to Reference: ▶ 4(p.426) and set up the output contents for each output number.

Output Format (Parallel Data Output)

- In the Item Tab area, tap [Output format] and select [Format] in the output setting area.

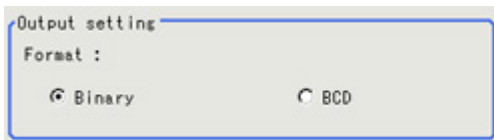

Set value [factory default]	Description
[Binary]	Data is output as 2's complement binary data. For 2's complement Reference: ▶ See "User's Manual", "Terminology Explanations" (p.339)
BCD	Data is output expressing 1 digit with 4 bits and expressing 3-digit integers and signs with 16 bits. <ul style="list-style-type: none"> 15 to 12 bits Sign. (positive: 0000, negative: 1111) 11 to 0 bits Data is expressed with 1 digit for every 4 bits and is expressed from the hundreds place (bits 11 - 8: 3rd digit) to the ones place (bits 3 - 0: 1st digit).

- Tap [OK].
The settings are finalized.

Measurement Results for Which Output Is Possible (Parallel Data Output)

The following values can be output using processing items related to results output. It is also possible to reference measurement values from expressions and other processing units.

Measurement item	Character string	Description
Judgement	JG	Judgement result
Data 0 to 7	D00 to D07	Results of expressions set for output data 0 to 7

Parallel Judgement Output

Used in the Following Case

- Used when outputting judgement results to external devices such as a programmable controller or PC via the parallel interface.

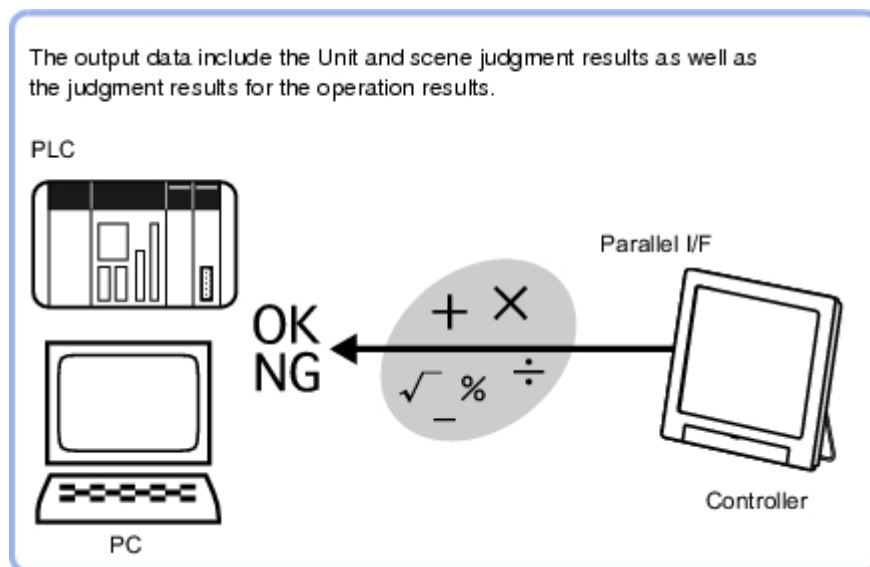

Important

- When performing measurements in the ADJUST window, the values are only output when external output is enabled by the following method during the measurement.
 - In the Control area, check "Output" in [Test measurement].When the measurement is executed in the RUN window, output is executed regardless of the external output setting.
- Even if this processing item is not set up in the scene, the overall judgement for the set processing items is still output via the OR signal from the parallel interface.

Settings (Parallel Judgement Output)

This sets the data for outputting judgement results in parallel.

Up to 16 target data items (0 - 15) can be set.

In the 2-LINE RANDOM mode, set the judgement result to be output to No. 0 to 7.

For line 0, the result is output to DO0 to 7.

For line 1, the result is output to DO8 to 15.

1. In the Item Tab area, tap [Setting].

- In the list, tap the output No. for which the expression is to be set.

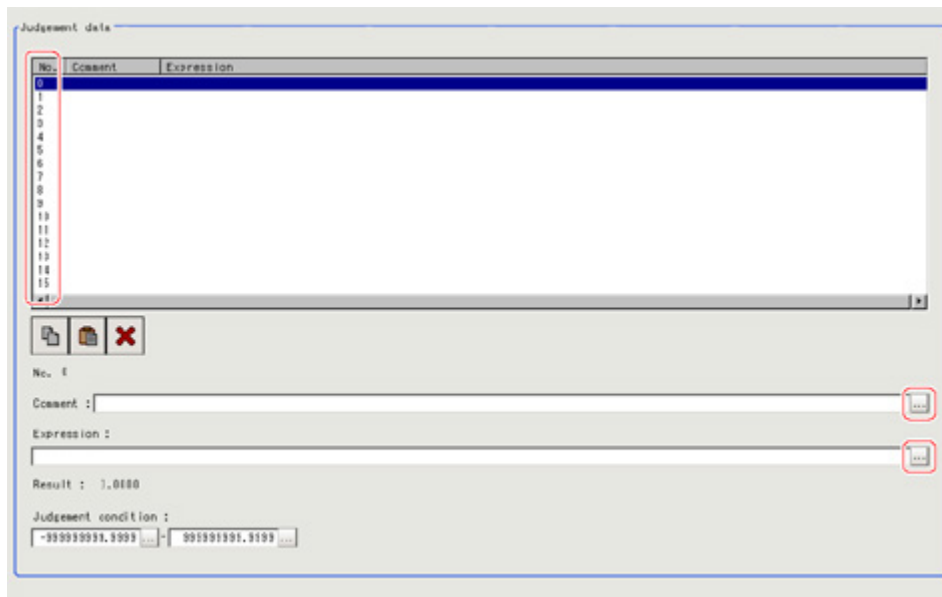

The selected output No. is displayed under the list.

- Tap [...] for the expression and set the expression.
Reference: ▶ Layout of Setting Expression Window (p.343)
- In "Judgement condition", set the judgement upper limit and lower limit.

Setting item	Set value	Description
Judgement condition	-99999999.9999 to 99999999.9999	This is a judgement condition for the expression. Specify the upper/lower limits to be judged as OK.

- Input an explanation of the expression in "Comment" as necessary.
- Repeat steps Reference: ▶ 2(p.429) to Reference: ▶ 4(p.429) and set up the output contents for each output number.

Output Parameters (Parallel Judgement Output)

Specifies whether or not the judgement result of this processing unit is reflected in the scene overall judgement.

- Tap [Output parameter] in the Item Tab area.
- Choose whether or not to reflect this in the scene overall judgement in "Reflect to overall judgement" area.

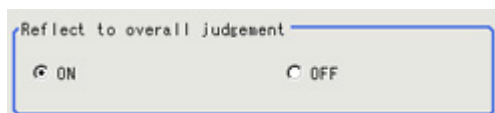

Setting item	Set value [factory default]	Description
Reflect to overall judgement	<ul style="list-style-type: none"> • [ON] • OFF 	Enables choosing whether or not the judgement result of this processing unit is reflected in the scene overall judgement.

Measurement Results for Which Output Is Possible (Parallel Judgement Output)

The following values can be output using processing items related to results output. It is also possible to reference measurement values from expressions and other processing units.

Measurement item	Character string	Description
Judgement	JG	Judgement result
Data 0 to 15	D00 to D15	Results of expressions set for output judgement data 0 to 15
Judge 0 to 15	J00 to J15	Results of judgement on expressions set for output judgement data 0 to 15

Fieldbus Data Output

Used in the Following Case

- Used when outputting data to an external device, such as a programmable controller, via the Fieldbus interface.

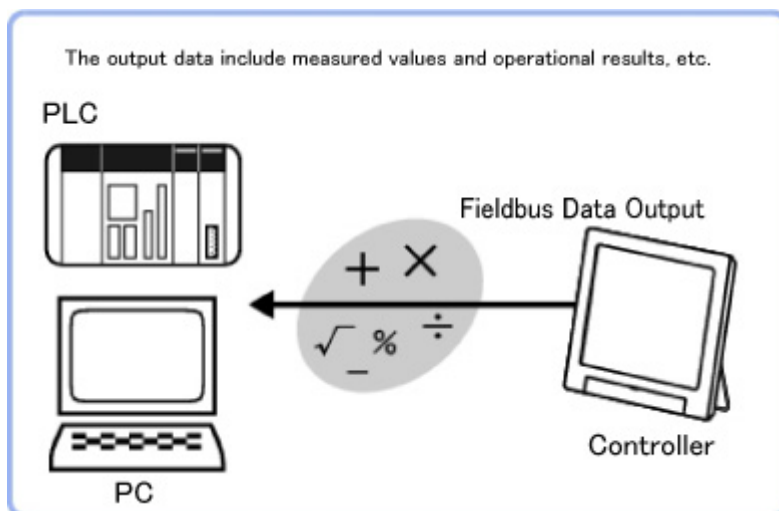

Important

- When performing measurements in the ADJUST window, the values are only output when external output is enabled by the following method.
 - In the Control area, check "Output" in [Test measurement].
- When the measurement is executed in the RUN window, output is executed regardless of the external output setting.

Settings (Fieldbus Data Output)

Set up the output contents with the expression.

Up to 8 expressions including 0 to 7 can be set in each unit.

1. In the Item Tab area, tap [Setting].

- In the list, tap the output number for which the expression is to be set.

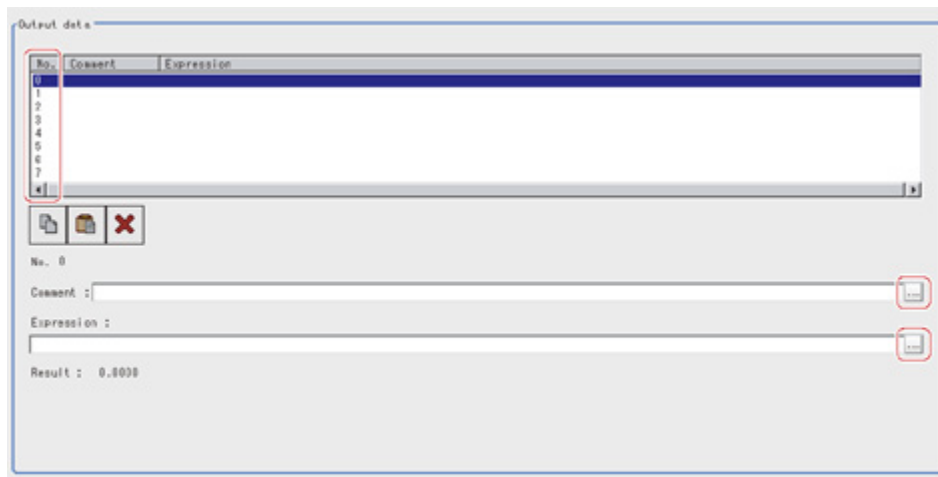

- The selected output number is displayed under the list.
- Tap [...] for the expression and set the expression.
 - Input an explanation of the expression at [Comment] as necessary.
 - Repeat steps Reference: ▶ 2(p.420) to Reference: ▶ 5(p.421) and set the output content of each output number.

Output Format (Fieldbus Data Output)

- In the Item Tab area, tap [Output format].
- Select the output format.

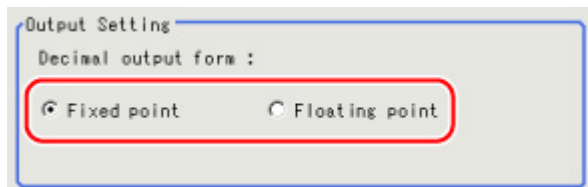

Set value [Factory default]	Description	
Decimal output form		
	Fixed point	Data is output multiplied by 1000. Example: For 123.456, 0x0001E240
	Floating point	Data is output in floating point format. Example: For -123.4567, 0xc2f6e979

Key Points for Test Measurement and Adjustment (Fieldbus Data Output)

The following content can be confirmed in the "Detail result" area using text.

Displayed items	Description
Judge	Judgement result
Expression0-7	Results of expressions 0 - 7

Measurement Results for Which Output Is Possible (Fieldbus Data Output)

The following values can be output using processing items related to results output. It is also possible to reference measurement values from expressions and other processing units.

Measurement item	Character string	Description
Judgement	JG	Judgement result
Data 0 to 7	D00 to D07	Results of expressions set for output data 0 to 7



Output result

Display result

This chapter describes how to display strings and figures in the window that displays the measurement results.

- ▶ Reference: Result Display (p.436)
- ▶ Reference: Display Image File (p.441)
- ▶ Reference: Display Last NG Image (p.443)

Result Display

Used in the Following Case

For your convenience in verifying measurement results, text and figures will be displayed in the Image Display area.

The following content can be displayed.

Example) Displaying options, such as Display string, Display value, Display judge, Display item name, Display date, on screen.

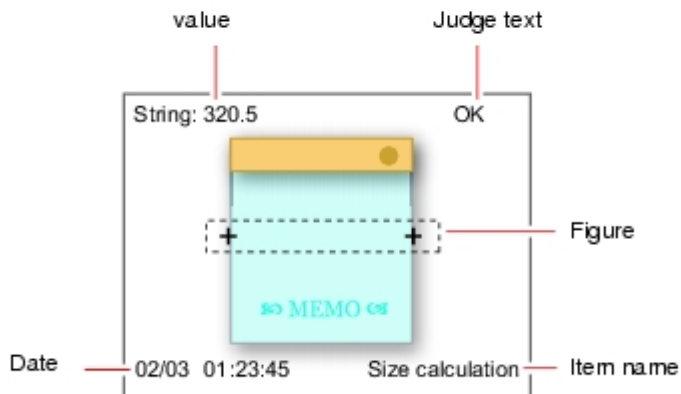

Example) Display the cross-shaped cursor at the measured position of the label.

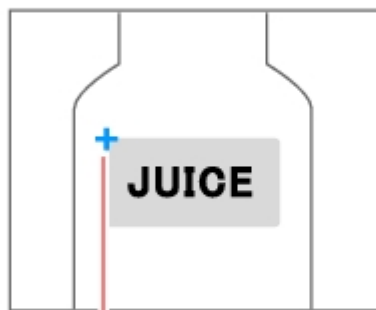

Display the cross-shaped cursor at the measured position.

Result Display

1. In the "List of result display" area, select the number with which to set the object and tap [Add].

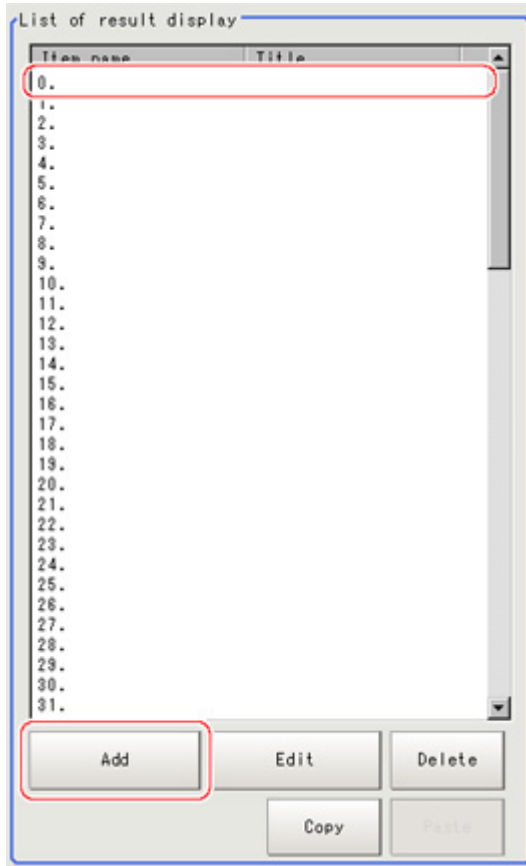

2. Select the object to be added in the Select Items to Display window and tap [OK].

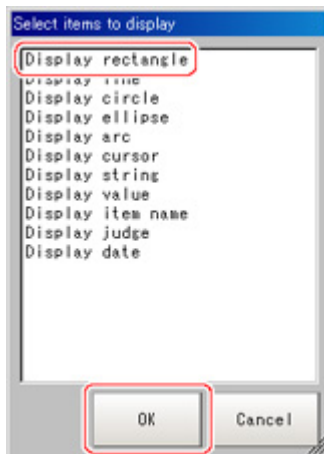

The selected object is added to the "List of result display" area and the Image Display area.

- In the "List of result display" area, select the object and tap [Edit].

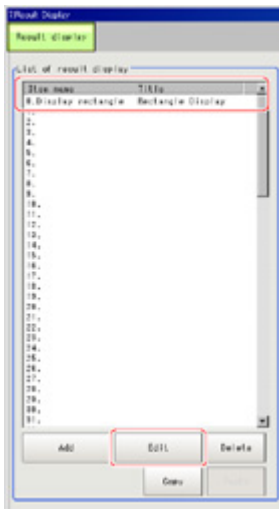

Setting options are displayed. The setting items are different depending on the object.

- Tap [Change title] as necessary to change titles displayed in the list of result display.

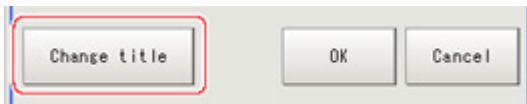

Up to 15 characters can be entered.

When Rectangle, Line, Wide Circle, Ellipse, Arc, or Crosshair Cursor is Selected

Specify display position, style, width, and color of figure.

Setting item	Setting item	Description
Display position Disp pos	Figure (or Numerical)	Select this if you would like the figure to always display in the same location. Methods for specifying display position include drawing the figure on the window and indicating coordinates numerically. If you would like to always display the figure in a reference position, set up an expression using "Operation".
	Operation	Select this when you would like to change display position for each measurement based on the measured value. Set up the expression to specify the display position.
Style	<ul style="list-style-type: none"> • Solid line • Dashed line 	Select the line type.
Width	1 to 10	Modify the line width.
Color	OK Color	Displayed in green.
	NG Color	Displayed in red.
	Judgement	Displayed using OK color or NG color based on the judgement results. Specify measurement values subject to judgement and set up respective judgement conditions.
	Arbitrary color	Displayed using specified color. Methods for specifying color include specifying by tapping on a color chart and specifying RGB values.

When String Display, Measurement, Processing Item Name, Judge Display, or Display Date is Selected

Sets display position, size, and color etc. of characters.

Common settings

Setting item	Setting item	Description
Display position	Figure (or Numerical)	Select this if you would like the figure to always display in the same location. Methods include specifying by tapping on the window and specifying coordinate values. However, if you would like to always display the figure in a reference position, set an expression using "Operation".
	Operation	Select this when you would like to change display position for each measurement based on the measured value. Set up the expression to specify the display position.

Detail

Setting item	Setting item	Description
Align	<ul style="list-style-type: none"> · Top · Bottom · Left · Center · Right 	Specify the alignment of the text.
	Size	10 to 200
Angle	0 to 359	Specify the display angle.
Style	<ul style="list-style-type: none"> · Bold · Italic · Under line · Mark out 	Specify the character decoration.
	Color	OK Color
NG Color		Displayed in red.
Judgement		Displayed using OK color or NG color based on the judgement results. Specify measurement values subject to judgement and set up respective judgement conditions.
Arbitrary color		Displayed using specified color. Methods for specifying color include specifying by tapping on a color chart and specifying RGB values.

String display

Setting item	Description
Set letter	Set characters within 64 characters.

Judge display

Setting item	Description
Judge type	Specify measurement values subject to judgement and set up respective judgement conditions. Displays using OK letter or NG letter based on the judgement results.
Judgement condition	
OK letter	Sets characters displayed for the case that judgement results are OK.

NG letter	Sets characters displayed for the case that judgement results are NG.
-----------	---

Display date

Setting item	Setting item	Description
Date kind	<ul style="list-style-type: none"> · Month/Day/Hour/Minute/Second · Month/Day/Hour/Minute · Hour/Minute/Second · Hour/Minute 	Select display format Please adjust the calendar time that comes with the controller in advance. Reference: ▶ "User's Manual", "Setting the Date and Time [Date-time Setting]" (p.139)

Measurement

Setting item	Setting item	Description
Measurement	–	Specify the measurement value you would like to display using expression.
Integer	1 to 10	Specify the digits of the integer part including the sign. For positive numbers, the plus sign is not output. Example Setting: 4 digits, data -5619 -999 is output.
Decimal	0 to 4	Set the number of decimal fraction digits. Decimals are rounded up and output. When 0 is selected, the decimal digits will be rounded off.

Processing item name

Setting item	Description
Processing Item	Choose processing item name from among the scenes being displayed.

Display Image File

Displays image files in USB memory or RAMDisk.

Used in the Following Case

- Use when you want to display camera input images to be used as reference or work images that are OK.

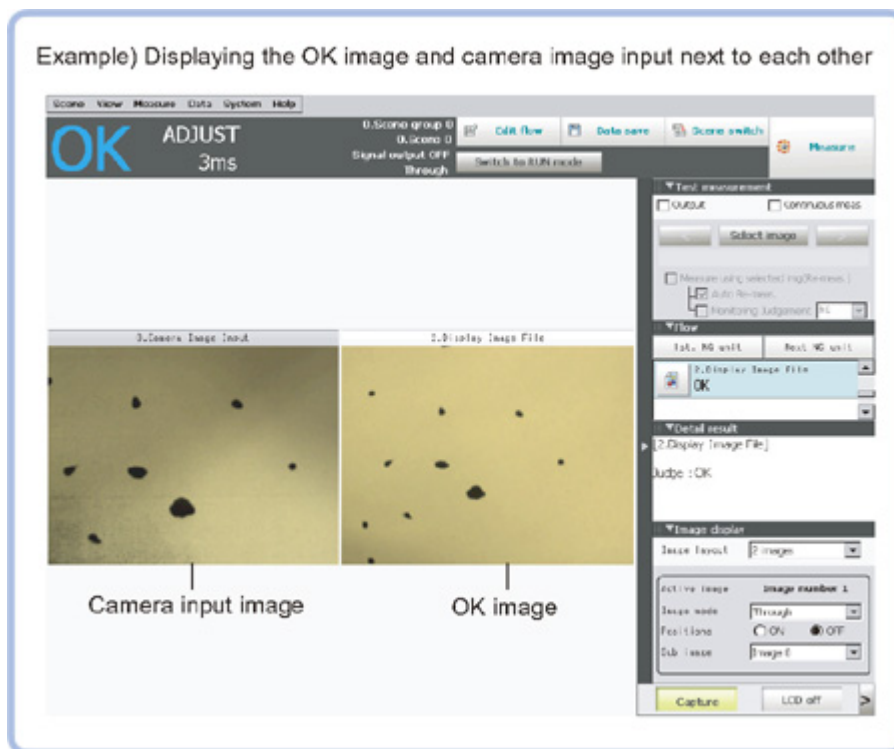

Select Image (Display Image File)

1. Set the number of image files to be registered.
Up to 4 can be specified.

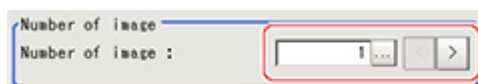

2. Specify the image to be displayed.
In the case that there are multiple images in an image file, specify the camera number.

Important

- Only image logging files (ifz format) and BMP format image files for which the region size is 1600 x 1200 or less can be specified.

3. Select image to be displayed using select display.

4. Tap [OK].

The settings are finalized.

Note

- The images in image file 0 to 3 can be displayed by specifying the sub image number on the RUN window/ADJUST window.
Reference: ▶ See "User's Manual", " Changing Display Contents " (p.83)

Key Points for Test Measurement and Adjustment (Display Image File)

The following content can be confirmed in the "Detail result" area using text.

Displayed items	Description
Judge	Judgement result

Display Last NG Image

Data, images and drawn data (up to 4 sets) for a NG based on NG conditions defined using an expression can be saved. As the saved image is stored in memory, it is maintained even if operations are performed in the window.

Used in the Following Case

- Image and data for NG case are saved.

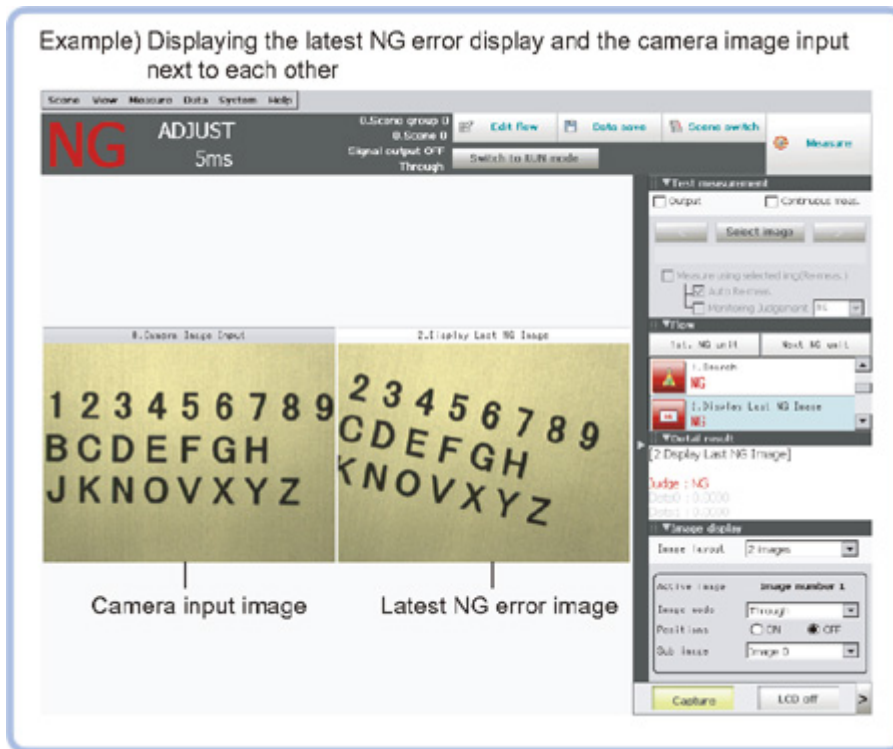

NG Error Judgement (Display Last NG Image)

Sets conditions for NG judgement.

1. Tap [NG judgement] in the Item Tab area.
2. Set the judgement mode in the "NG settings" area.

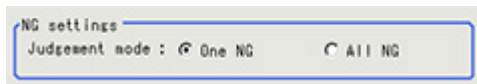

Setting item	Set value [factory default]	Description
Judgement mode	[One NG]	The image is saved even if only one of the judgement criteria set using "Judgement expression" has a judgement of NG.
	All NG	The image is saved if all of the judgement criteria set using "Judgement expression" have a judgement of NG.

Expression Settings

The measurement details used for NG judgement are set using an expressions.

1. Tap the "No." for setting the expression from the list in the "Expression setting" area
The No. selected will be displayed below the list.

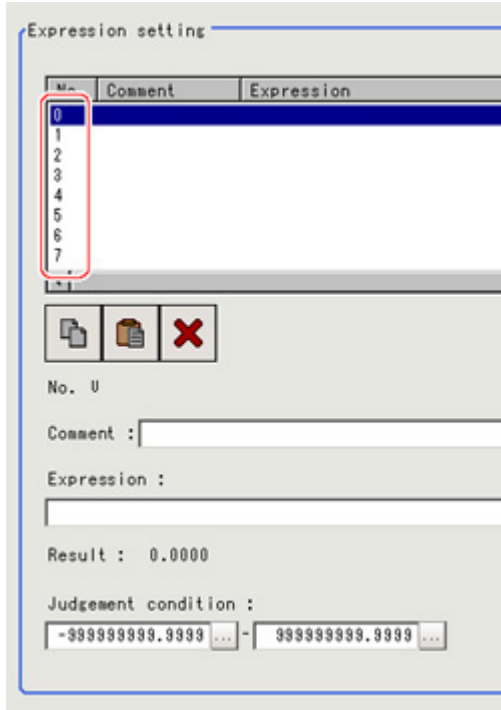

2. Tap [...].

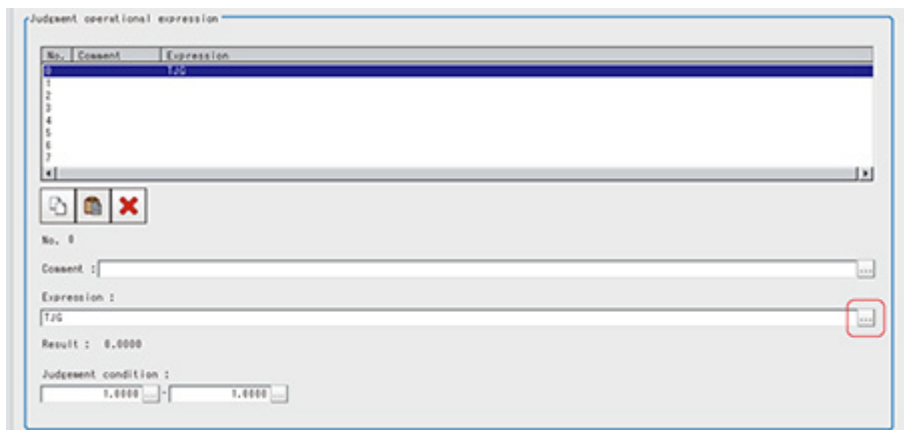

The Setting Expression window is displayed.

- Set the judgement operational expression.

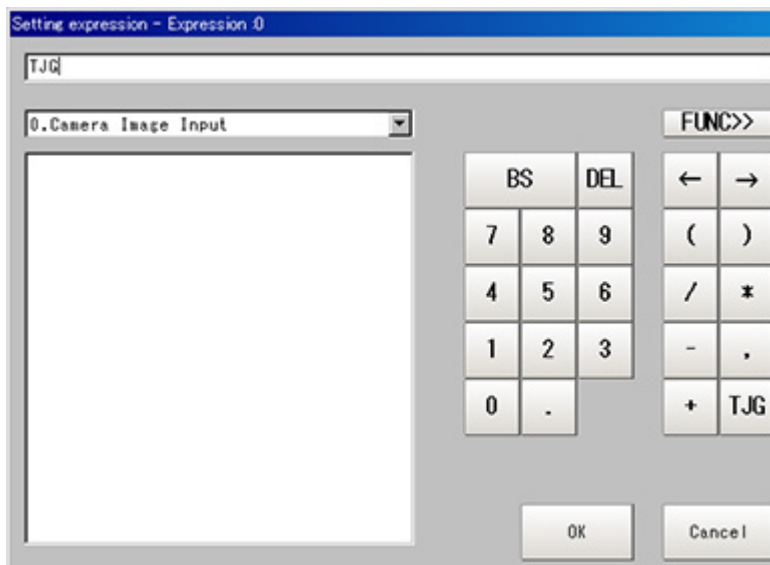

Reference: ▶ Layout of Setting Expression Window (p.343)

- After setting the expression, tap [OK].
The expression is confirmed.
- Tap [...] for "Comment" and input an explanation of the expression as necessary.
- Set up the judgement upper limit and the judgement lower limit for "Judgement condition".

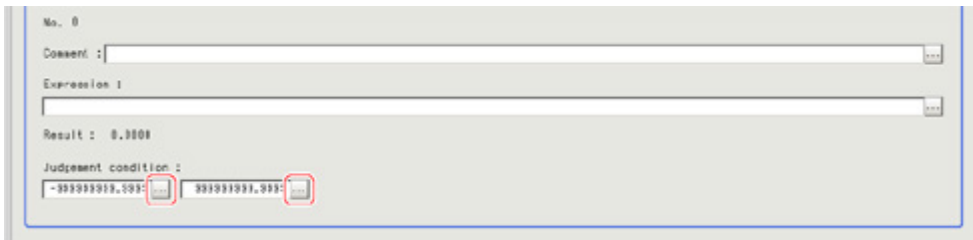

Setting item	Set value [Factory default]	Description
Judgement condition	-99999999.9999 to 99999999.9999	This is a judgement condition for the expression. Set upper and lower limits for judging as OK.

- Repeat the Steps Reference: ▶ 1 (p.444) to Reference: ▶ 6 (p.445) and set up the expression.

Image Saving (Display Last NG Image)

Specifies the target unit to be saved and number of times images are saved when an NG occurs.

- Tap [Image save] in the Item Tab area.
- Specify each of the following items.



Setting item	Set Value [Factory default]	Description
Number of logging	[1] to 4	Sets the number of NG images that are saved. A maximum of 4 NG images consisting of Last NG, Last 1 NG, Last 2 NG, Last 3 NG can be saved.
Unit	-	Specifies target processing unit for saving image. Select the unit (camera input image, image with pre-processing or position compensation) with the image you would like to save. Please select a unit before the unit being processed as the target unit.
Set an image for next unit	<ul style="list-style-type: none"> · Checked · [Unchecked] 	Check when using an image acquired by a processing unit after this unit.

3. Set up the expression.

Reference: ▶ Expression settings (p.444)

Note

- Saved images are stored in sub images 0 to 3.
To display sub images
Reference: ▶ See "User's Manual", "Changing Display Contents" (p.83)

Data Saving (Display Last NG Image)

Sets data to be saved when an NG occurs.

1. Tap [Saving data] in the Item Tab area.
2. Specify each of the following items.

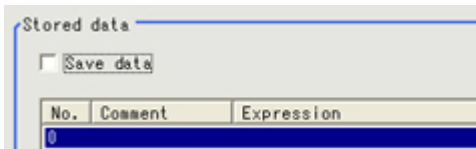

Setting item	Set Value [Factory default]	Description
Stored data	[Unchecked] Checked	Check when saving measurement data using an expression when NG occurs. In conjunction with the number of saves, a maximum of 4 items of measurement data from Last NG, Last 1 NG, Last 2 NG, Last 3 NG can be saved for one expression. Please set the expression to reference a unit prior to the unit currently being processed.

3. Set up the expression.

Reference: ▶ Expression settings (p.444)

4. Set up the judgement condition.

Output Parameters (Display Last NG Image)

Specifies whether or not the judgement result of this processing unit is reflected in the scene overall judgement.

1. Tap [Output parameter] in the Item Tab area.

- Choose whether or not to reflect the judgement result in the scene overall judgement in the "Reflect to overall judgement" area.



Setting item	Set Value [Factory default]	Description
Reflect to overall judgement	<ul style="list-style-type: none"> [ON] OFF 	Enables choosing whether or not the judgement result of this processing unit is reflected in the scene overall judgement.

Key Points for Test Measurement and Adjustment (Display Last NG Image)

The following content is displayed in the "Detail result" area as text.

Displayed items	Description
Data 0 comment	Expression result of Expression 0
Data 1 comment	Expression result of Expression 1
Data 2 comment	Expression result of Expression 2
Data 3 comment	Expression result of Expression 3
Data 4 comment	Expression result of Expression 4
Data 5 comment	Expression result of Expression 5
Data 6 comment	Expression result of Expression 6
Data 7 comment	Expression result of Expression 7
Data 8 comment	Expression result of Expression 8
Data 9 comment	Expression result of Expression 9
Data 10 comment	Expression result of Expression 10
Data 11 comment	Expression result of Expression 11
Data 12 comment	Expression result of Expression 12
Data 13 comment	Expression result of Expression 13
Data 14 comment	Expression result of Expression 14
Data 15 comment	Expression result of Expression 15

Measurement Results for Which Output Is Possible (Display Last NG Image)

The following values can be output using processing items related to results output. It is also possible to reference measurement values from expressions and other processing units.

Measurement items	Character string	Description
Judgement	JG	Judgement result
Judge data 00 to 07	JD 00 to 07	Calculation data 00 to 07 for inclusion 0
Judge judge 00 to 07	JJ 00 to 07	Calculation judgement 00 to 07 for inclusion 0
Last NG data 00 to 15	D000 to 15	NG data 00 to 15
Last NG judge 00 to 15	J000 to 15	Judge NG 00 to 15
Last 1 NG data 00 to 15	D100 to 15	Last N NG data 00 to 15

Last 1 NG judge 00 to 15	J100 to 15	Last N NG judge 00 to 15
Last 2 NG data 00 to 15	D200 to 15	Last N NG data 00 to 15
Last 2 NG judge 00 to 15	J200 to 15	Last N NG judge 00 to 15
Last 3 NG data 00 to 15	D300 to 15	Last N NG data 00 to 15
Last 3 NG judge 00 to 15	J300 to 15	Last N NG judge 00 to 15

Manual Revision History

The manual revision symbol is an alphabet appended at the end of the manual number found in the bottom left-hand corner of the front or back cover.

Cat. No. Z291-E1-05

↑
Revision No.

Rev. No.	Rev. Date	Revision Contents	Software Version
01	Dec. 2008	Software version upgrade from Ver.2.0 to Ver.2.1	Ver.2.1
02	Oct. 2009	Special function corresponding to FZ3-9 □ □ /H9 □ □ series	Ver.3.0
03	Feb. 2010	FZ3-3 □ □ /H3 □ □ /7 □ □ /H7 □ □ series supports the newly added functions	
04	Jan. 2011	Software version upgrade and new functions are added	Ver.3.4
04A	Jun. 2011	Minor corrections	
05	Dec. 2011	Software version upgrade and new functions are added	Ver.3.52

Index

Value	
1 unit scroll	294
2 unit scroll	294
2D Code+	277

A	
Angle range	51, 63, 102, 114
Anti Color Shading	321
Area defect level	221
Area meas. LV	230
ASCII	421

B	
Background Suppression	309
Background Suppression level	307
Barcode+	269
BCD	426
Binary (Parallel Data Output)	426
Binary (Data Output)	421
Binary level	171, 184, 203
Boundary inspection	236
Boundary level	236
Bright adjust setting	38

C	
Calculation	340
Calibration	26
Calibration+	359
Camera Image Input	12
Camera Image Input HDR	34
Camera Image Input HDR Lite	40
Camera switching	44
Candidate point level	86
Character count	248, 273, 279, 281
Character Inspection	244
Check digit	272
Circle Regression	356
Circle Angle	274
Classification	110
Code parameters	256
Code type	271, 279
Color	279
Color chroma	315
Color Data	162
Color deviation	165
Color difference	165
Color Gray Filter	312
Color OUT	124, 142, 156
Color to count	134
Comparison element display	231
Conditional Branch	408
Coordinate	31
Correlation (search mode)	56
Cut out angle	337

D	
Data logging	391
Data Output	420
Date Verification	252
Defect detection mechanism	220
Defects size	220
Defect	217
Density average	166
Density change (Edge Position)	127
Density change (Scan Edge Position)	145
Density deviation	167
Derivation	127, 145, 158
Detection mode	124, 142, 156
Detection point	49
DI Branch	415
Dictionary candidate	247
Dictionary parameters	245
Difference	238
Dilate	306
Direction	228, 247, 323
Display Image File	441
Display Last NG Image	443
Dynamic Range	42

E	
EC Circle Search	90
ECM Search	79
Edge color level	126, 134, 145, 158
Edge color specification	123, 141, 155
Edge Pitch	130
Edge No.	126, 127, 145
Edge Position	120
Elapsed time	396
Element	231
End	413
Erosion	306
Error model registration	84
Ethernet	249, 272, 281, 421
Extract Color Filter	316
Extract horizontal edges	306
Extract vertical edges	306

F	
Field	17
Fieldbus Data Output	431
Fill profile	317
Filling up holes	176, 187, 207, 317
Filtering	304
Fine Matching	233
Flexible Search	59
Focus	23, 399
Frame	17
Freeze image	305, 313, 321, 328

G	
Gain	16

Get Unit Data	366	Plain inspection	71
Get Unit Figure	373	Polar Transformation	336
Gravity and Area	168	Position Compensation	292
Grouping distance	96	Positive polarity	19
<hr/>			
H		Precise (Edge Pitch)	134
Halation Cut+	327	Precise Defect	225
HDR mode	36	Prev. unit image	325
High contrast mode	36	Profile	231
Histogram	383	Projection	127, 145, 158
Horizontal succession	247	<hr/>	
HSV filter	313, 314	R	
Hue range	314	Reduction (ECM Search)	86
<hr/>			
I		Reference position	124
Image logging	388	Region inspection mode	222
Intelligent camera	21	Reset scroll	294
IP address	423	Result Display	436
Iris	24, 402	RGB filter	313
<hr/>			
L		Righthand	31
Label Data	194	RS-232C/RS-422	421
Labeling	180	<hr/>	
Labeling+	198	S	
Lefthand	31	Scan Edge Position	138
Lighting	19	Scan Edge Width	152
Line Bright	22	Scan sub-region	140, 154
Line Regression	351	Search	48
<hr/>			
M		Search mode	51, 62, 114
Magnification (calibration)	32	Search skipping (ECM Search)	86
Mask size (ECM Search)	83	Sensitive Search	68
Mask size (Filter size: Scan Edge Position)	140	Set Unit Data	364
Mask size (Filter size: Scan Edge Width)	154	Set Unit Figure	368
Measurement history display	381	Shape Search+	100
Measurement Image Switching	46	Shutter speed	16
Median	306	Size change	82, 102
Model Dictionary	261	Skipping angle	51, 62, 82, 287
Model re-registration	46	Smart mode	51, 62, 70, 114, 264
Model skipping (ECM Search)	86	Source image	294, 297
Move axis	82, 102	Stability	51, 63, 70, 114, 265
Multi search	95	Standard hue	314
Multiple output	55	STEP-STGOUT delay	19
<hr/>			
N		STGOUT pulse polarity	19
Narrow bar size	272	STGOUT pulse width	19
NG sub-region	75	Stripes Removal Filter+	324
Noise cancel	146, 352	Sub-model parameter	77
Noise level	127	Sub-pixel	54, 64, 74, 116
Noise width	127	Sub-region margin	75
Normalization (Color Data)	164	Succession level	106
Normalization (Fine Matching)	237	<hr/>	
<hr/>			
O		T	
OCV	247	Through image display	305, 313, 321, 328
Outside trimming	188, 207	Trapezoidal Correction+	296
Overlap	337	Trend graph	383
<hr/>			
P		Trend Monitor	376
Panorama+	330	<hr/>	
Parallel Data Output	425	V	
Parallel Judgement Output	428	Vertical succession	247
Perturbation	237	<hr/>	
<hr/>			
W		Wait	398
White balance	26	White balance	26
Wide bar size	272	Wide bar size	272
<hr/>			
Z		Zoom (intelligent camera)	24

OMRON Corporation Industrial Automation Company

Tokyo, JAPAN

Contact: www.ia.omron.com

Regional Headquarters

OMRON EUROPE B.V.

Wegalaan 67-69-2132 JD Hoofddorp
The Netherlands

Tel: (31)2356-81-300/Fax: (31)2356-81-388

OMRON ELECTRONICS LLC

One Commerce Drive Schaumburg,
IL 60173-5302 U.S.A.

Tel: (1) 847-843-7900/Fax: (1) 847-843-7787

OMRON ASIA PACIFIC PTE. LTD.

No. 438A Alexandra Road # 05-05/08 (Lobby 2),
Alexandra Technopark,
Singapore 119967

Tel: (65) 6835-3011/Fax: (65) 6835-2711

OMRON (CHINA) CO., LTD.

Room 2211, Bank of China Tower,
200 Yin Cheng Zhong Road,
PuDong New Area, Shanghai, 200120, China

Tel: (86) 21-5037-2222/Fax: (86) 21-5037-2200

Authorized Distributor:

© OMRON Corporation 2011 All Rights Reserved.
In the interest of product improvement,
specifications are subject to change without notice.

Cat. No. Z291-E1-05

1112