

OMRON

Profile Measuring System

Z500

Operation Manual

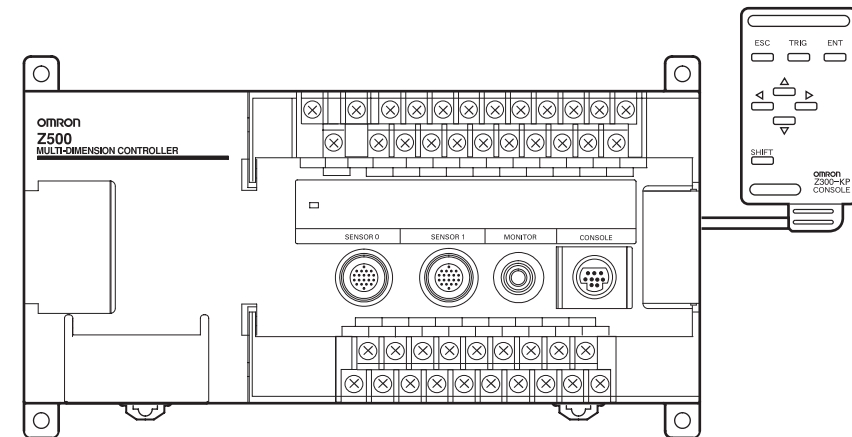

OMRON

Profile Measuring System Z500

Manual 2: Operation Manual

Cat. No. Z159-E1-2

OMRON

Authorized Distributor:

Cat. No. Z159-E1-2

Note: Specifications subject to change without notice.

Printed in Japan
0103-0.5C

Cat. No. Z159-E1-2



Manual

2



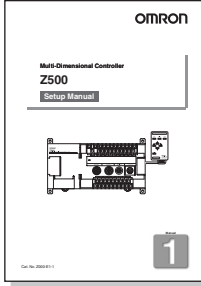

About this Manual

Please read the following manuals carefully and be sure you understand the information provided before attempting to install or operate the Z500.

Manual 1: Setup Manual

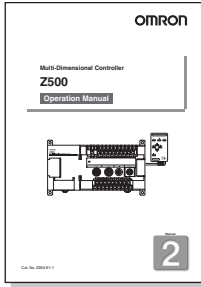
 <p>Cat. No. Z158-E1-2</p>	Installation 	<p>This manual describes the hardware for the Z500 (Multi-Dimensional Controller) and how to install the components.</p> <p>Be sure to read this manual first.</p>
	Wiring	

Manual 2: Operation Manual

 <p>Cat. No. Z159-E1-2</p>	Starting the Z500 and Positioning the Workpiece 	<p>SECTION 2 Basic Operations This section describes how to start the Z500 and how to display images on the monitor.</p>
	Adjusting Images 	<p>SECTION 3 Menus for Conversational Menu</p> <ul style="list-style-type: none"> • Basic settings required for measurement • Measurement of consistent workpieces <p>Menus for Conversational Menu Settings can be made easily by entering information as requested - just as though you are having a conversation with the Z500.</p>
	Setting Measurement Conditions and Executing 	<p>SECTION 4 Menus for Expert Menu</p> <ul style="list-style-type: none"> • Customized settings • Detailed settings • Measurement of workpieces placed at different positions <p>Menus for Expert Menu More detailed setting, such as position compensation for workpieces placed at different positions, can be made.</p>
	Outputting to External Devices	<p>SECTION 7 I/O Format This section provides details on the inputs and outputs used for communications with external devices via terminal blocks or RS-232C.</p> <ul style="list-style-type: none"> • Communications settings • I/O format • Timing for communications

OMRON Corporation
Industrial Automation Company

Application Sensors Division
Sensing Devices and Components Division H.Q.
Shiokoji Horikawa, Shimogyo-ku, Kyoto, 600-8530 Japan
Tel:(81)75-344-7068 / Fax:(81)75-344-7107

Regional Headquarters

OMRON EUROPE B.V.
Sensor Business Unit
Carl-Benz Str. 4, D-71154 Nufringen,
Germany
Tel:(49)7032-811-0 / Fax:(49)7032-811-199

OMRON ELECTRONICS LLC
1 East Commerce Drive, Schaumburg, IL 60173
U.S.A.
Tel:(1)847-843-7900 / Fax:(1)847-843-8568

OMRON ASIA PACIFIC PTE.LTD.
83 Clemenceau Avenue, #11-01, UE Square,
239920 Singapore
Tel:(65)835-3011 / Fax:(65)835-2711

OMRON CHINA CO.,LTD.
BEIJING OFFICE
Room 1028, Office Building,
Beijing Capital Times Square,
No.88 West Chang'an Road,
Beijing, 100031 China
Tel:(86)10-8391-3005 / Fax:(86)10-8391-3688

Multi-Dimensional Controller Z500

Z500-MC10E/MC15E

Operation Manual

INTRODUCTION	2
SECTION 1 Features	9
SECTION 2 Basic Operations	19
SECTION 3 Menus for Conversational Menu	39
SECTION 4 Menus for Expert Menu	53
SECTION 5 Other Functions	109
SECTION 6 System Settings	143
SECTION 7 I/O Format	153
SECTION 8 Troubleshooting	183

Manual



Special or Critical Applications

When the Z500 will be used in one of the conditions or applications listed below, allow extra safety margins in ratings and functions, add extra safety feature such as fail-safe systems, and consult your OMRON representative.

- Operating conditions or environments which are not described in the manual
- Nuclear power control systems, railroad systems, aviation systems, vehicles, combustion systems, medical equipment, amusement equipment, or safety equipment
- Other systems, machines, and equipment that may have a serious influence on lives and property and require extra safety features

Product Availability

Some of the products listed may not be available in some countries. Please contact your nearest OMRON sales office by referring to the addresses provided at the back of this manual.

Regulations and Standards

The Z500 complies with the international regulations and standards below:

- EC Regulations
EMC Directive: No.89/336/EEC
- EN Standards (European Standards)
EN61326:1997 + A1:1998 + A2:2001 (EMI:Class A)

© OMRON, 2003

All rights reserved. No part of this publication may be reproduced, stored in a retrieval system, or transmitted, in any form, or by any means, mechanical, electronic, photocopying, recording, or otherwise, without the prior written permission of OMRON.

No patent liability is assumed with respect to the use of the information contained herein. Moreover, because OMRON is constantly striving to improve its high-quality products, the information contained in this manual is subject to change without notice. Every precaution has been taken in the preparation of this manual. Nevertheless, OMRON assumes no responsibility for errors or omissions. Neither is any liability assumed for damages resulting from the use of the information contained in this publication.

Table of Contents

INTRODUCTION	3
Table of Contents.....	3
Precaution on Safety	5
Menus.....	6
Editor's Note.....	8
 SECTION 1	
Features	9
1-1 Features of the Z500.....	10
1-2 Operational Flow.....	14
 SECTION 2	
Basic Operations	19
2-1 Starting the Z500 and Displaying Images.....	20
2-2 Menu Operations	23
2-2-1 Input Device	23
2-2-2 Screen Displays.....	24
2-2-3 Menu Tree	25
2-2-4 Inputting Values	27
2-2-5 Adjustment Menu	28
2-3 Screen Types and Display Methods	29
2-3-1 Image Monitor.....	30
2-3-2 Profile Monitor	33
2-3-3 Digital Monitor	35
2-3-4 Trend Monitor	36
2-4 Saving Settings and Exiting the Z500.....	37
 SECTION 3	
Menus for Conversational Menu	39
3-1 Setting Measurement Conditions Using the Conversational Menus.....	40
Step 1 Starting Conversational Menus	40
Step 2 Setting Basic Measurement Conditions	41
Step 3 Setting Measurement Contents	48
Step 4 Setting Measurement Conditions	49
Step 5 Setting Output Contents.....	50
Step 6 Starting Measurements	51
3-2 Saving Settings and Exiting the Z500.....	52

SECTION 4

Menus for Expert Menu.....	53
4-1 Setting Measurement Conditions Using the Expert Menus.....	54
Step 1 Starting Up Expert Menu and Entering Set Mode	54
Step 2 Adjusting Images	56
Step 3 Position Compensation	64
Step 4 Measurement Settings.....	70
Step 5 Measurement Conditions	88
Step 6 Output Settings	100
Step 7 Performing Measurement.....	107
4-2 Saving Settings and Exiting the Z500.....	108

SECTION 5

Other Functions	109
5-1 Executing Force-zero	110
5-2 Entering Display Mode.....	112
5-3 Changing the Screen Display	113
5-4 Changing Scenes	125
5-5 Entering Tools Mode	128
5-6 Testing Measurement Performance (Test).....	129
5-7 Checking the Line Beam Position (Surrounding image)	135
5-8 Backing Up Data to a Computer.....	136

SECTION 6

System Settings	143
6-1 Entering System Mode.....	144
6-2 Setting RS-232C Communications Specifications (<i>Comm</i>)	145
6-3 Environment Settings.....	146
6-4 Downloading the Sensor Information to the Controller.....	148
6-5 Compensating Installation Error (<i>Slant correct</i>).....	149
6-6 Initializing the Z500 (<i>Initialize</i>).....	151
6-7 Checking the System Version (<i>Version</i>)	152

SECTION 7

I/O Format	153
7-1 Terminal Blocks.....	154
7-2 RS-232C.....	159
7-3 Analog Output.....	180

SECTION 8

Troubleshooting	183
8-1 Troubleshooting	184
Index.....	187

Precaution on Safety

OMRON products are manufactured for use according to proper procedures by a qualified operator and only for the purposes described in this manual.

The following conventions are used to indicate and classify precautions in this manual. Always heed the information provided with them. Failure to heed precautions can result in injury to people or damage to property.



DANGER

Indicates an imminently hazardous situation which, if not avoided, will result in death or serious injury.



WARNING

Indicates a potentially hazardous situation which, if not avoided, could result in death or serious injury.



CAUTION

Indicates a potentially hazardous situation which, if not avoided, may result in minor or moderate injury, or property damage.



WARNING

Failure to read and understand the information provided in this manual may result in personal injury or death, damage to the product, or product failure. Please read each section in its entirety and be sure you understand the information provided in the section and related sections before attempting any of the procedures or operations given.

Menus

Menus for Conversational Menu

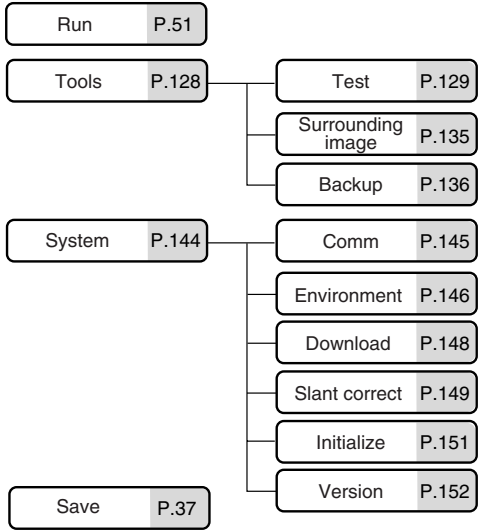
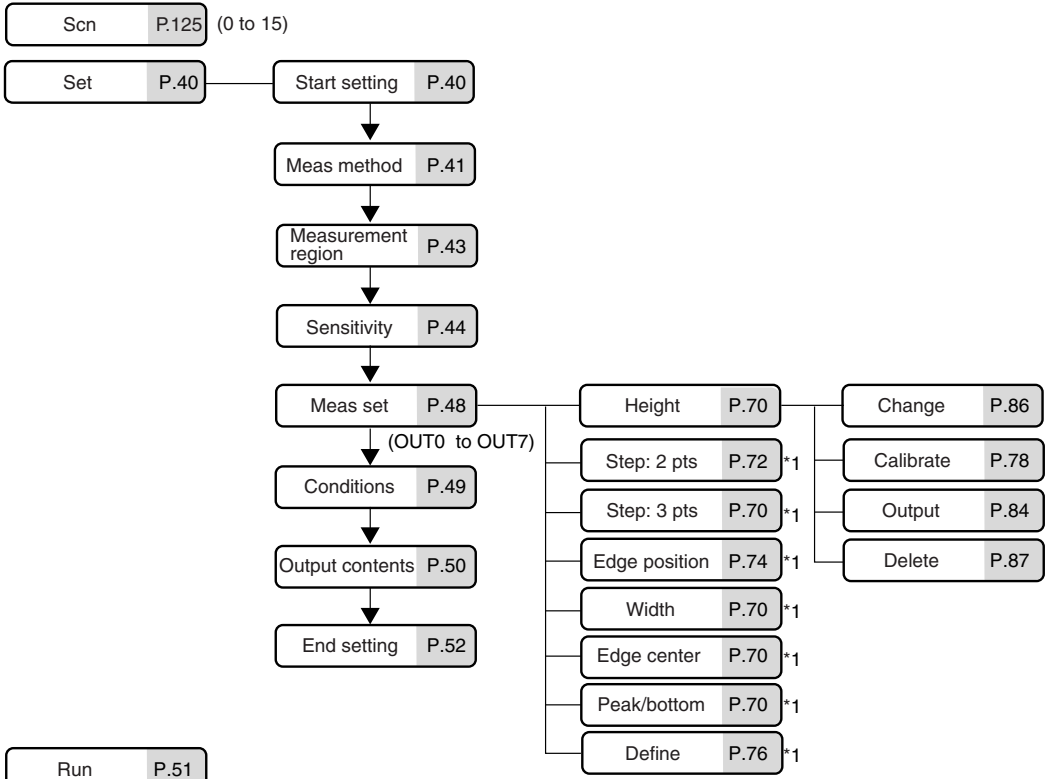

*1: The same construction as that for **Height**
When **Define** has been selected, however, setting of **Calibrate** is disabled.

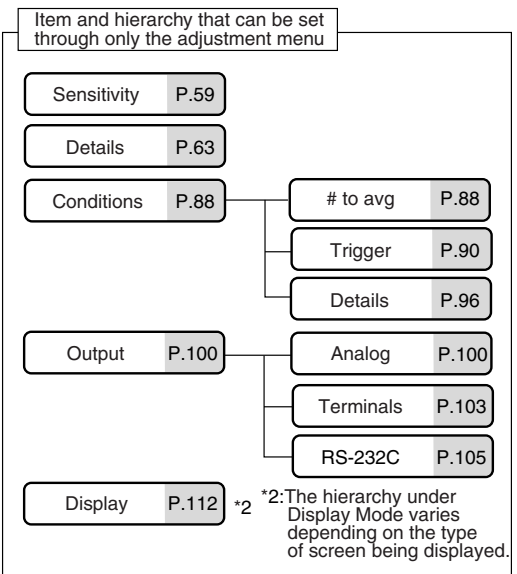

Menus for Expert Menu

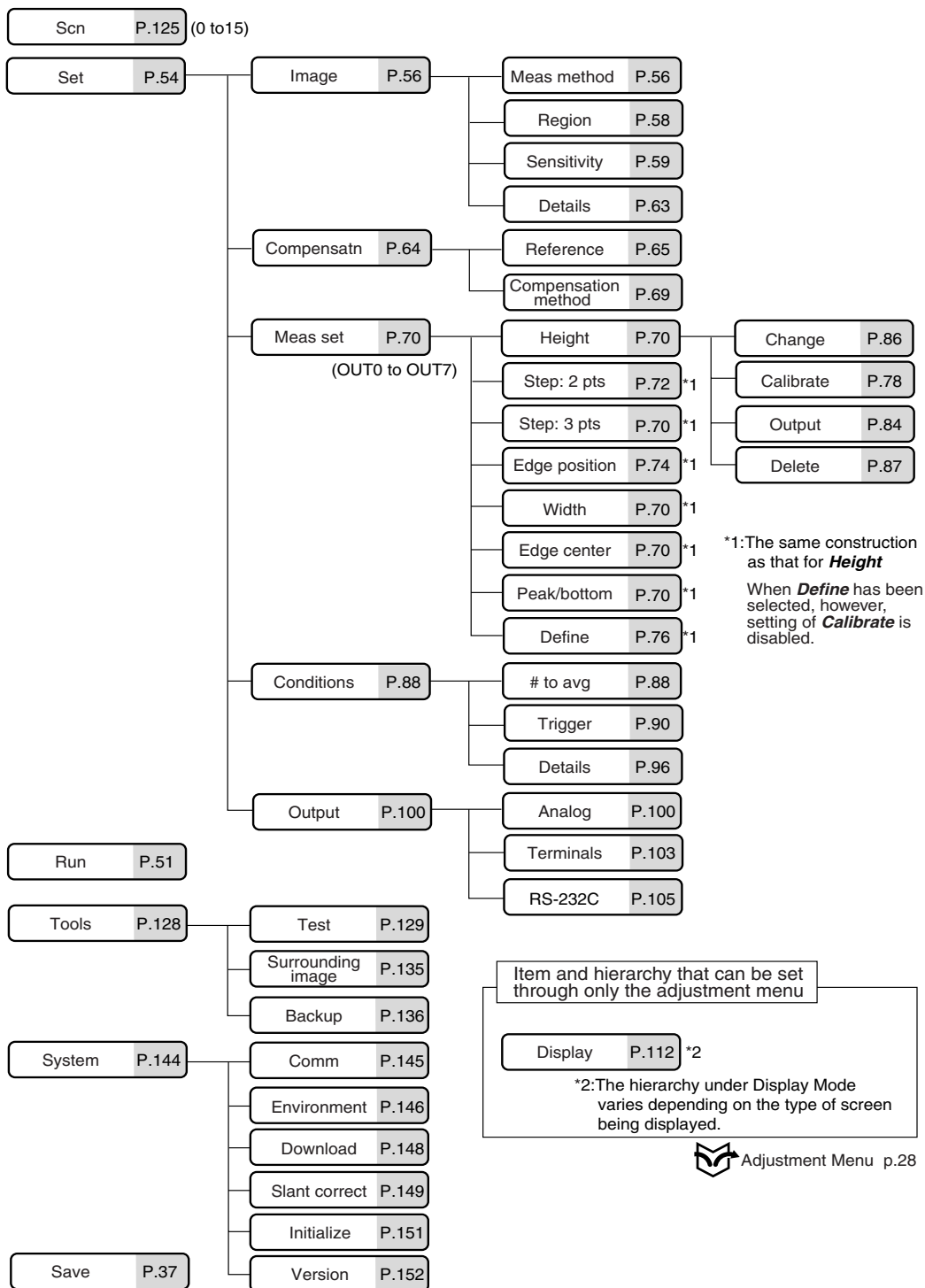

Editor's Note

Visual Aids



NOTICE

The following headings appear in the left column of the manual to help you locate different types of information.

Indicates information required to take full advantage of the functions and performance of the product. Incorrect application methods may result in the loss of damage or damage to the product. Read and follow all precautionary information.



CHECK

Indicates points that are important in using product functions or in application procedures.



REFERENCE

Indicates where to find related information.



TwoSensor

Indicates information required when using 2 sensors.



HELP

Indicates information helpful in operation.

Notation

Screen Messages

In this manual, screen message are given in bold/italic.

E.g.: **System**

System/Backup means the Menu is hierarchical.

OMRON Product References

All OMRON products are capitalized in this manual. The word "Unit" is also capitalized when it refers to an OMRON product, regardless of whether or not it appears in the proper name of the product.

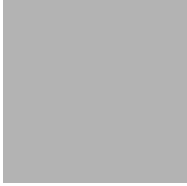

Z500
Operation Manual

SECTION 1

Features

SECTION 1 explains the features of the Z500 and the flow of operation using the Conversational and Expert Menus.

1-1 Features of the Z500	10
1-2 Operational Flow	14

1-1 Features of the Z500

1-1-1 Eight Measurement Items for Various Detection Needs

Select the measurement item according to application.

Complicated detection is also possible, by combining multiple measurement items and with detailed settings.

Simultaneous measurement can be performed at 8 points.

 **REFERENCE**

Refer to page 70.

- Height
- Edge position
- Peak/bottom
- Step : 2 pts
- Width
- Define
- Step : 3 pts
- Edge center

1-1-2 Simple Setup Using Menus

The Z500 has 2 types of menu. Set the measurement contents according to the menus displayed on the monitor screen.

Menus for Conversational Menu

Settings can be made easily by entering information as requested - just as though you are having a conversation with the Z500.

 **REFERENCE**

Refer to page 39.

Menus for Expert Menu

More detailed setting, such as position compensation for workpieces placed at different positions, can be made.

 **REFERENCE**

Refer to page 53.

1-1-3 A Variety of Output Formats

Not only is analog output available, but data output to external devices can also be performed via terminal blocks or RS-232C.

 **REFERENCE**

Refer to page 100.

1-1-4 Monitoring While Viewing the Measurement Status

The Z500 has 4 types of monitor. Monitoring suited to the application is possible at every stage from installation and measurement settings to operation and maintenance.

 **REFERENCE**

Refer to page 29.

Image Monitor

This is the main monitor of the Z500. Three pieces of information; measurement status, sensitivity, and measurement result, can be checked together with their target images.

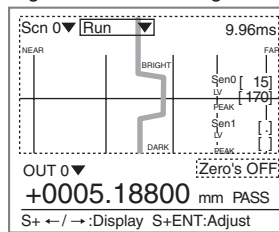

Digital Monitor

Two or more measurement results can be checked at the same time.

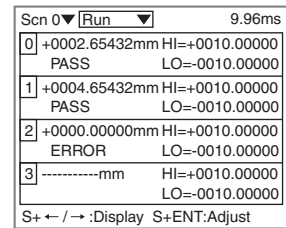

Profile Monitor

Chronological change of height distribution of 126 points (profile) can be checked on a shaded 3-D image.

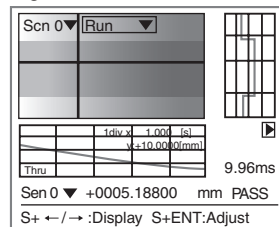

Trend Monitor

Chronological change of measured values can be checked.

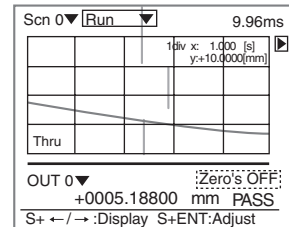

1-1-5 Flexible Settings for Data Output to External Devices

In addition to simply outputting measurement results, equations can be set to output to external devices using measurement and judgment results.

 REFERENCE

Refer to page 70.

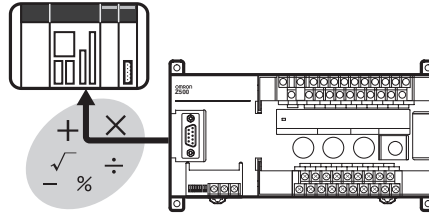

1-1-6 A Wide Variety of Useful Functions

Any Type of Workpiece can be Measured by Using the Image Adjustment Function

Higher measurement accuracy can be assured by using the sensitivity adjustment function, even if the workpieces to be measured have different brightness.

 REFERENCE

Refer to pages 44 and 59.

Adjustment Menu

Six types of adjustments are available on shortcut keys by displaying the adjustment menu.

 REFERENCE

Refer to page 28.

Checking Surrounding Images of the Area that the Line Beam Strikes

Displays images of the area surrounding the part that the line beam strikes. This function is useful when the Sensor is mounted inside an installation and the measurement area cannot be checked directly.

 REFERENCE

Refer to page 135.

Specifying Measurement Timing by Using the Trigger Function

Measurement timing can be specified arbitrarily by using the self-trigger and external trigger functions. Characteristic quantity can be held while the measurement is carried out.

(Measurement status at a set timing can be checked on the monitor screen.)



Refer to page 90.

Smooth Setup Changes

Scenes can be used to change between up to 16 types of measurement setups. Simply change the scene to change to a different measurement setup.



Refer to page 125.

1-2 Operational Flow

1-2-1 Menus for Conversational Menu

Turn ON the power.

Preparations for Detection

Displaying Images on the Monitor
Refer to page 20, 2-1
Starting the Z500 and Displaying Images.

Screen Types and Display Methods
Refer to page 29.

Refer to this section to learn about the basic operational flow from setting measurement conditions to executing measurements.
CHECK
 Refer to page 39 for information on settings using Conversational Menu.

Setting Detection Conditions and Executing

Starting Up Conversational Menu and Entering Set Mode
Refer to page 40, See
Step 1 : Starting Conversational Menus.

Setting Basic Measurement Conditions
Refer to page 41, See
Step 2 : Setting Basic Measurement Conditions.

Selecting and Setting Measurement Items
Refer to page 48, See
Step 3 : Setting Measurement Contents.
Refer to page 70 for details.

Setting Measurement Conditions (if necessary)
Refer to page 49, See
Step 4 : Setting Measurement Conditions.
Refer to page 88 for details.

Setting Output Contents
Refer to page 50, See
Step 5 : Setting Output Contents.
Refer to page 100 for details.

Starting Measurements
Refer to page 51, See
Step 6 : Starting Measurements.

Selecting Measurement Item Appropriate to the Measurement Goal
Refer to page 70.
Height
Step: 2 pts
Step: 3 pts
Edge position
Width
Edge center
Define

Confirming Settings

Performing Test
Refer to page 129, 5-6
Testing Measurement Performance (Test).

Checking the Line Beam Position
Refer to page 135, 5-7
Checking the Line Beam Position (Surrounding image).

SECTION 1
1-2 Operational Flow

Troubleshooting



When an error message has been displayed on the screen,
Refer to page 184, *8-1 Troubleshooting*.

Changing and Deleting Settings



Changing Measurement Contents
Refer to page 86.



Clearing Measurement Items
Refer to page 87.



Changing the Screen Display
Refer to page 113.

Saving Settings



Saving Detection Conditions
Refer to page 52, *3-2 Saving Settings and Exiting the Z500*.



Backing up Data
Refer to page 136, *5-8 Backing Up Data to a Computer (Backup)*.

Application Setting Operations



Executing Force-zero
Refer to page 110.



Communications with External Devices
Refer to page 145, *6-2 Setting RS-232C Communications Specifications (Comm)*.



I/O Format
Refer to page 153.



Setting Conditions by Model Type
Refer to page 125, *5-4 Changing Scenes*.



Setting System Environment Conditions
Refer to page 146, *6-3 Environment Settings*.



Initializing the Z500
Refer to page 151.

1-2-2 Menus for Expert Menu

Turn ON the power.

Preparations for Detection

Displaying Images on the Monitor
 Refer to page 20, 2-1
Starting the Z500 and Displaying Images.

Screen Types and Display Methods
 Refer to page 29.



Refer to this section to learn about the basic operational flow from setting measurement conditions to executing measurements.

Refer to page 54 for information on settings using Expert Menu.

Setting Detection Conditions and Executing

Starting Up Expert Menu and Entering Set Mode
 Refer to page 54, *Step 1 : Starting Up Expert Menu and Entering Set Mode.*

Adjusting Images
 Refer to page 56,
Step 2 : Adjusting Images.

Setting Position Compensation (if necessary)
 Refer to page 64,
Step 3 : Position Compensation.

Selecting and Setting Measurement Items
 Refer to page 70,
Step 4: Measurement Settings.

Selecting Measurement Item Appropriate to the Measurement Goal
 Refer to page 70.

- Height
- Step: 2 pts
- Step: 3 pts
- Edge position
- Width
- Edge center
- Define

Setting Measurement Conditions (if necessary)
 Refer to page 88,
Step 5 : Measurement Conditions.

Setting Output Contents
 Refer to page 100,
Step 6 : Output Settings.

Starting Measurements
 Refer to page 107,
Step 7 : Performing Measurement.



Troubleshooting

When an error message has been displayed on the screen,



Refer to page 184, 8-1 *Troubleshooting*.

Confirming Settings



Performing Test

Refer to page 129, 5-6
Testing Measurement Performance (Test).



Checking the Line Beam Position

Refer to page 135, 5-7
Checking the Line Beam Position (Surrounding image).

Changing and Deleting Settings



Changing Measurement Contents

Refer to page 86.



Clearing Measurement Items

Refer to page 87.



Changing the Screen Display

Refer to page 113.

Saving Settings



Saving Detection Conditions

Refer to page 108, 4-2
Saving Settings and Exiting the Z500.



Backing up Data

Refer to page 136, 5-8
Backing Up Data to a Computer (Backup).

Application Setting Operations



Executing Force-zero

Refer to page 110.



Communications with External Devices

Refer to page 145, 6-2
Setting RS-232C Communications Specifications (Comm).



I/O Format

Refer to page 153.



Setting Conditions by Model Type

Refer to page 125, 5-4
Changing Scenes.



Setting System Environment Conditions

Refer to page 146, 6-3
Environment Settings.



Initializing the Z500

Refer to page 151.

MEMO

SECTION 2

Basic Operations

SECTION 2 shows basic menu operations of the Z500.

2-1 Starting the Z500 and Displaying Images	20
2-2 Menu Operations	23
2-2-1 Input Device	23
2-2-2 Screen Displays	24
2-2-3 Menu Tree	25
2-2-4 Inputting Values	27
2-2-5 Adjustment Menu	28
2-3 Screen Types and Display Methods	29
2-3-1 Image Monitor	30
2-3-2 Profile Monitor	33
2-3-3 Digital Monitor	35
2-3-4 Trend Monitor	36
2-4 Saving Settings and Exiting the Z500	37

2-1 Starting the Z500 and Displaying Images

This section describes how to start the Z500 and how to display images on the monitor. Place the workpiece and adjust the Sensor position while monitoring the displayed image.

#1 Starting the Z500

1. Be sure that the basic Z500 components have been connected correctly.

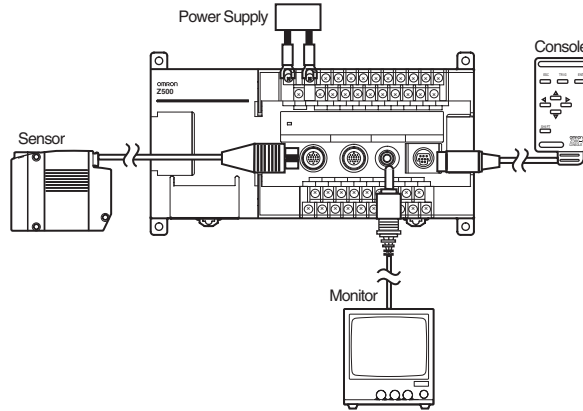

CHECK

Before connecting components or wiring power supply lines and grounding wires, be sure to refer to the relevant section in the *Setup Manual*.



REFERENCE

Refer to page 16 in the *Setup Manual*.

2. Turn ON the power supply to the monitor.
3. Turn ON the power supply to the Z500.

The Image Monitor will be displayed.

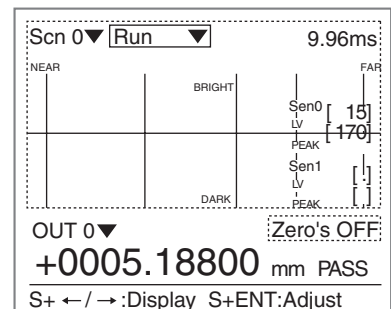

CHECK

If the Image Monitor is not displayed, use the **SHIFT + Right** Keys or **SHIFT + Left** Keys on the console to change the Monitors.



REFERENCE

Refer to page 29, *Screen Types and Display Methods*.

#2 Position the Workpiece and Adjust the Image

Position the workpiece to be measured and adjust the displayed image in the measurement range.

The measurement range varies depending on the Sensor models connected.

REFERENCE

Refer to page 26 in the *Setup Manual*.

Example: Z500-SW17

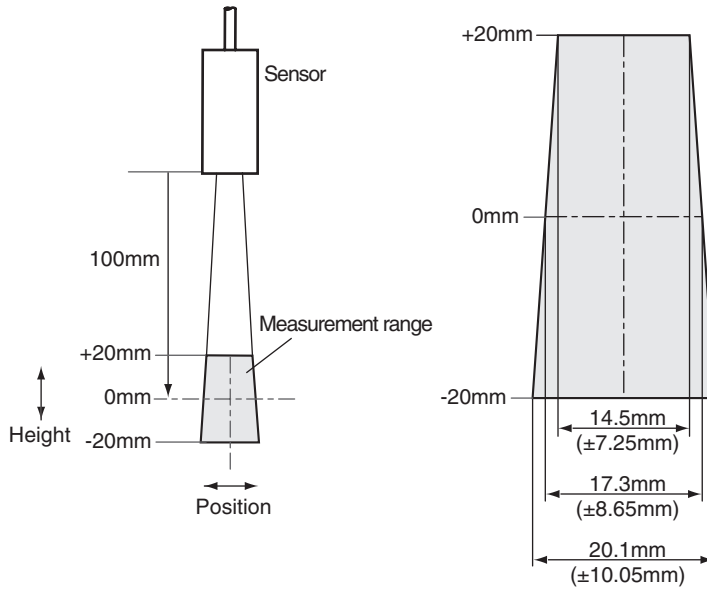

1. Position the workpiece.
In this example, the workpiece shown in the right figure will be described.

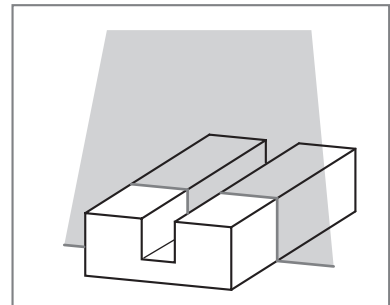

A profile graph showing the level differences in the workpiece will be displayed.

- Adjust the position of the workpiece if necessary.
Adjust the workpiece position if the Profile graph is not appeared in the center of the monitor.

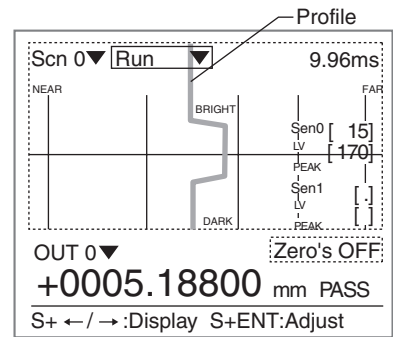
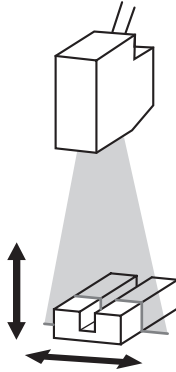

CHECK

If the lines representing level differences have swollen elliptically, the light density is excessive. If the lines are too thin to see, the light density is insufficient. In either case, adjust the sensitivity.



REFERENCE

Refer to page 59 for information on how to adjust sensitivity.

2-2 Menu Operations

2-2-1 Input Device

Menu operations are performed on the Console.

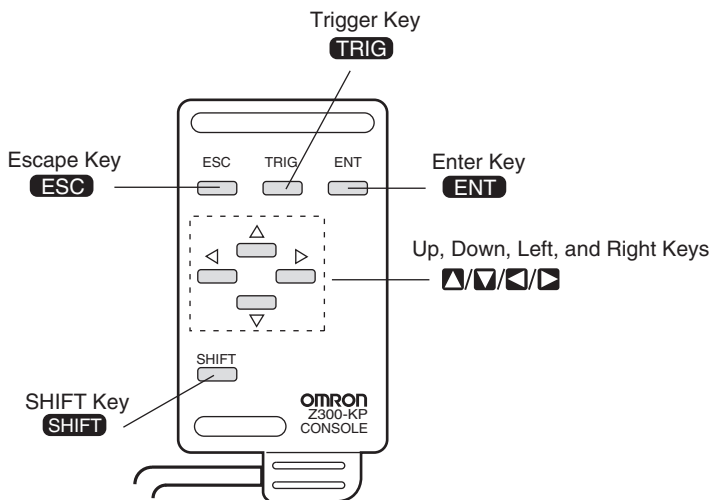

Key	Function
Escape Key	Returns the cursor to the previous menu display or operation.
Trigger Key	The effect of the Trigger Key varies with the function.
Enter Key	Executes a function or sets a value. Note: On the F160-KP, also functions as a Cursor Key.
SHIFT Key	Must be pressed in combination with another key to have any effect. Specific functions are assigned to combinations of the SHIFT Key and other keys for specific screens.
Up, Down, Left, and Right Keys	The Up and Down Keys are used to move the cursor up and down and also to set values. Use the Up Key to increase a value by 1. Use the Down Key to decrease a value by 1. Hold down the Up or Down Key to quickly increase or decrease a value. The Left and Right Keys are used to move the cursor left or right.

2-2-2 Screen Displays

The Z500 is operated by selecting functions displayed on the screen. Familiarize yourself with each function before operating the Z500.

Scene Number

There are 16 scenes. Setting different measurement conditions for each one allows easy switching between different setups.

Mode (See the table below)

The current operating mode is displayed.

Cursor Keys

The cursor is moved to the desired function by pressing the **Up**, **Down**, **Left**, and **Right** Keys.

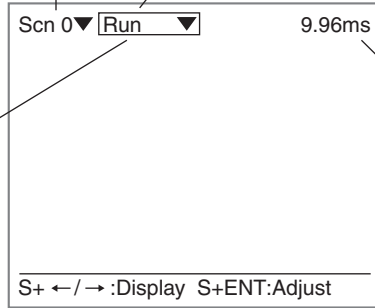

Measurement period (Sampling time)

It varies depending on the item to be measured.

Key Operations

Displays special key combinations at the bottom of the screen where available. S refers to the **SHIFT** Key. "S + ENT" indicates that the **ENT** Key should be pressed while the **SHIFT** Key is pressed.

Mode

Display	Description
Set	Mode to set the inspection conditions.
Run	Performs measurement. The measurement results are output to an external device via terminal block or RS-233C.
Tools	Used to save settings and images to a computer as backup.
System	Used to set system conditions for the Z500. Select this mode to switch menus and settings for communications with external devices.
Save	Used to save data to flash memory in the Z500. If new settings have been made, be sure to save the data before quitting.

2-2-3 Menu Tree

Z500 menus are hierarchical. The cursor is moved to the required functions to set measurement conditions. Use the following procedures to move around the menu tree.

1. Move the cursor to the item to be moved. (Move the cursor to the desired function in Set Mode using the **Up** and **Down** Keys.)
2. Press the **ENT** Key.

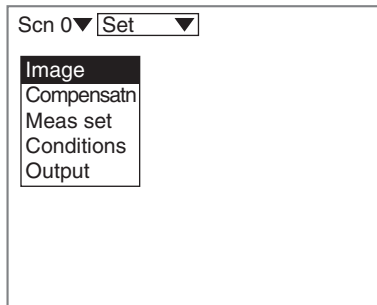

In this example, the cursor will move to the *Image* Menu.

3. Repeat (1.) and (2.) to move the cursor to lower levels.

Press the **ESC** Key once to move to the upper level.

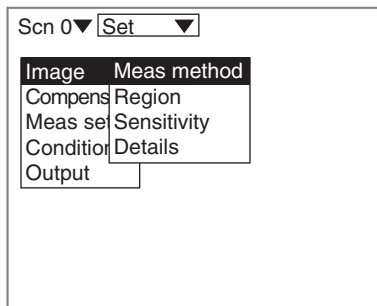

Triangle Mark

Items with an inverted triangle after them have a list of alternatives. The method for selecting the alternatives is given here.

1. Move the cursor to the item to be set.
In this example, move the cursor to **Baud rate**.
2. Press the **ENT** Key.

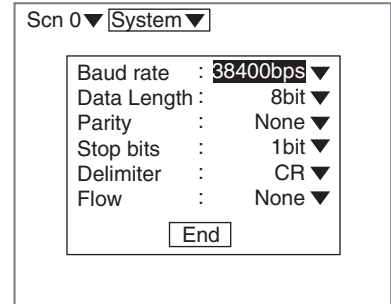

The selections will be displayed.

3. Move the cursor to the desired baud rate using the **Up** and **Down** Keys.
4. Press the **ENT** Key.

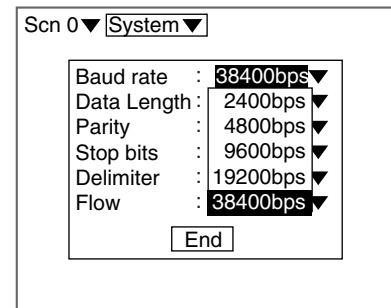

The selections will be registered.

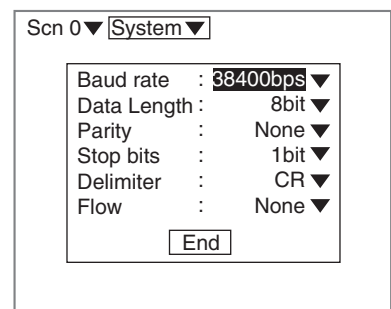

2-2-4 Inputting Values

The section explains how to input values when setting judgment or measurement conditions.

1. Move the cursor to the item for which a value is to be changed.
2. Press the **ENT** Key.

Scn 0 ▼ Set ▼

judgement width	:	[0.01000]
Edge width	:	[0.00000]
Smoothing	:	None ▼
Noise	:	2pixel ▼
Level	:	50.0% ▼
Error data	:	Clamp ▼
Profile	:	None ▼
Peak/btm width	:	5pixel ▼

End

The cursor will change to a cursor the size of a single digit.

3. Move the cursor to the digit to be changed using the **Left** and **Right** Keys.

Scn 0 ▼ Set ▼

judgement width	:	[0000.01000]
Edge width	:	[0.00000]
Smoothing	:	None ▼
Noise	:	2pixel ▼
Level	:	50.0% ▼
Error data	:	Clamp ▼
Profile	:	None ▼
Peak/btm width	:	5pixel ▼

End

4. Change the value.
Use the **Up** Key to increase the value.
Use the **Down** Key to decrease the value.
5. Repeat (4.) to change other values.
6. Press the **ENT** Key.

Scn 0 ▼ Set ▼

judgement width	:	[0000.02000]
Edge width	:	[0.00000]
Smoothing	:	None ▼
Noise	:	2pixel ▼
Level	:	50.0% ▼
Error data	:	Clamp ▼
Profile	:	None ▼
Peak/btm width	:	5pixel ▼

End

The values will be set.

Scn 0 ▼ Set ▼

judgement width	:	[0.02000]
Edge width	:	[0.00000]
Smoothing	:	None ▼
Noise	:	2pixel ▼
Level	:	50.0% ▼
Error data	:	Clamp ▼
Profile	:	None ▼
Peak/btm width	:	5pixel ▼

End

2-2-5 Adjustment Menu

Press the **SHIFT + ENT** Keys in Run Mode. The adjustment menu will be displayed.

The adjustment menu is useful to display the set screens of the following six items without passing through the menu hierarchies.

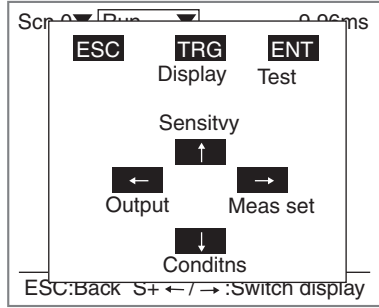

Key	Allocation	Reference
Trigger Key	Display	P.112
Enter Key	Test	P.129
Up Key	Sensitivity	P.59
Down Key	Conditions	P.88
Left Key	Output	P.100
Right Key	Meas set	P.70
Escape Key	None	-



The adjustment menu can be performed from the Image Monitor, the Digital Monitor, the Profile Monitor, or the Trend Monitor.

2-3 Screen Types and Display Methods

There are 4 Monitors to display images on the Z500; Image Monitor, Digital Monitor, Trend Monitor, and Profile Monitor. These monitors are useful to check measurement information as required from various viewpoints. Use the **SHIFT + Right Keys** or **SHIFT + Left Keys** on the console to change the Monitors. The first time the power supply is turned ON after delivery, the Image Monitor is displayed.

Image Monitor

This is the main monitor of the Z500. Three pieces of information; measurement status, sensitivity, and measurement result, can be checked together with their target images.

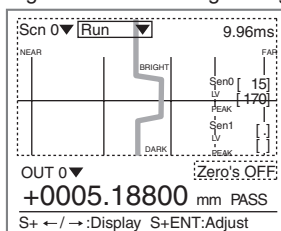

Digital Monitor

Two or more measurement results can be checked at the same time.

Scn	Run	9.96ms
0	+0002.65432mm HI=+0010.00000 PASS LO=-0010.00000	
1	+0004.65432mm HI=+0010.00000 PASS LO=-0010.00000	
2	+0000.00000mm HI=+0010.00000 ERROR LO=-0010.00000	
3	-----mm HI=+0010.00000 LO=-0010.00000	

S+ ← / → :Display S+ENT:Adjust



Profile Monitor

Chronological change of height distribution of 126 points (profile) can be checked on a shaded 3-D image.

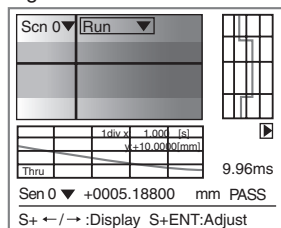

Trend Monitor

Chronological change of measured values can be checked.

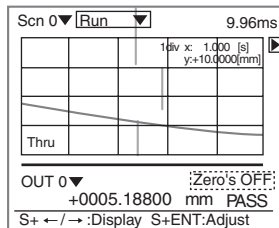

CHECK

Enable to select which Monitor will be displayed when the Z500 turns ON.



REFERENCE

Refer to page 146.



CHECK

Measurement continues even while the screen is switched.

2-3-1 Image Monitor

This is the main monitor of the Z500. The first time the power supply is turned ON after delivery, this screen is displayed. Mostly used to check the measurement status, sensitivity information, and measurement results.

Image Monitor consists of 2 displays; Measurement status display and Measurement sensitivity display. Use the **TRIG** Key to change the displays.

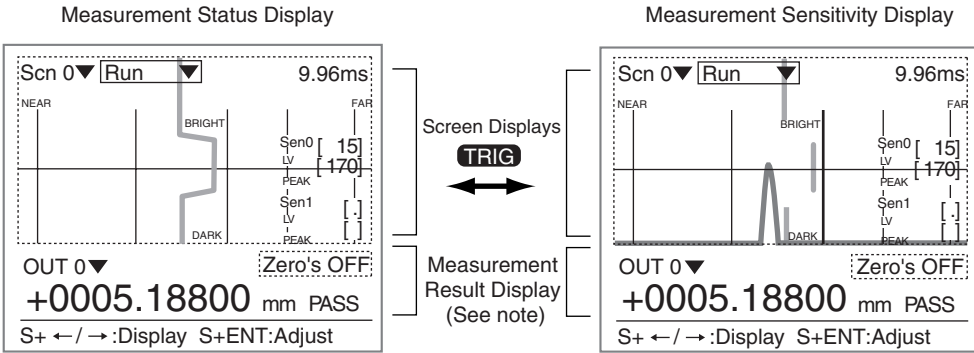

Note: Common to Measurement status display and Measurement sensitivity display.

Measurement Status Display

The height information within the measurement range can be checked. The height information between 0 and 125 lines is displayed with the Profile graph.

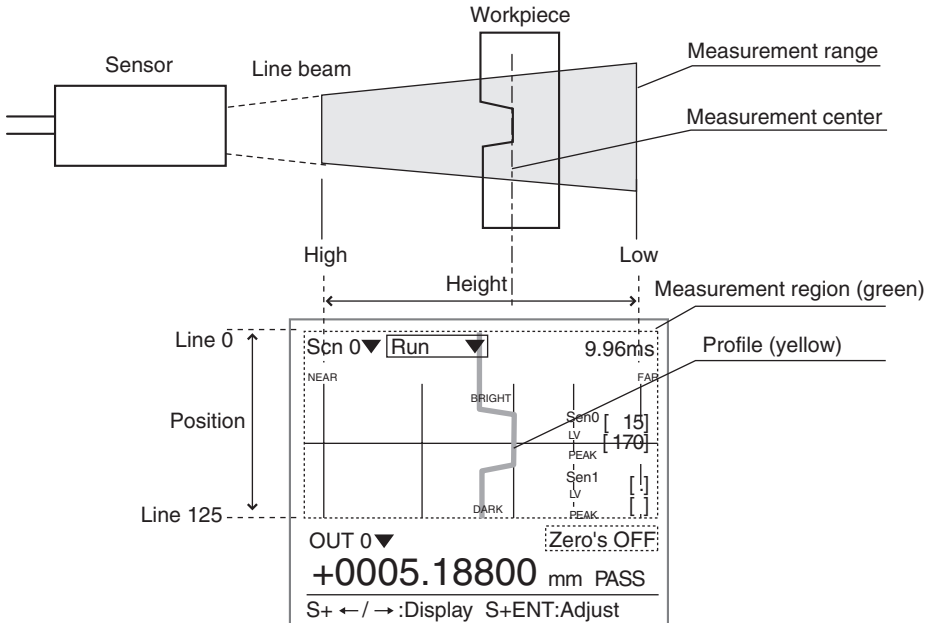



The Profile graph can be enlarged.



Refer to page 113.



The Profile graph can be output as a measurement value to an external device.



Refer to page 101.



Whether or not the lines interfering with the measurement should be interpolated can be determined.



Refer to page 99.



The measurement region can be changed.



Refer to page 58.

Measurement Sensitivity Display

The Measurement sensitivity level (LV) and received level (PEAK) can be checked. The light density and the status of the workpiece surface at a cursor position are displayed with the line brightness graph.

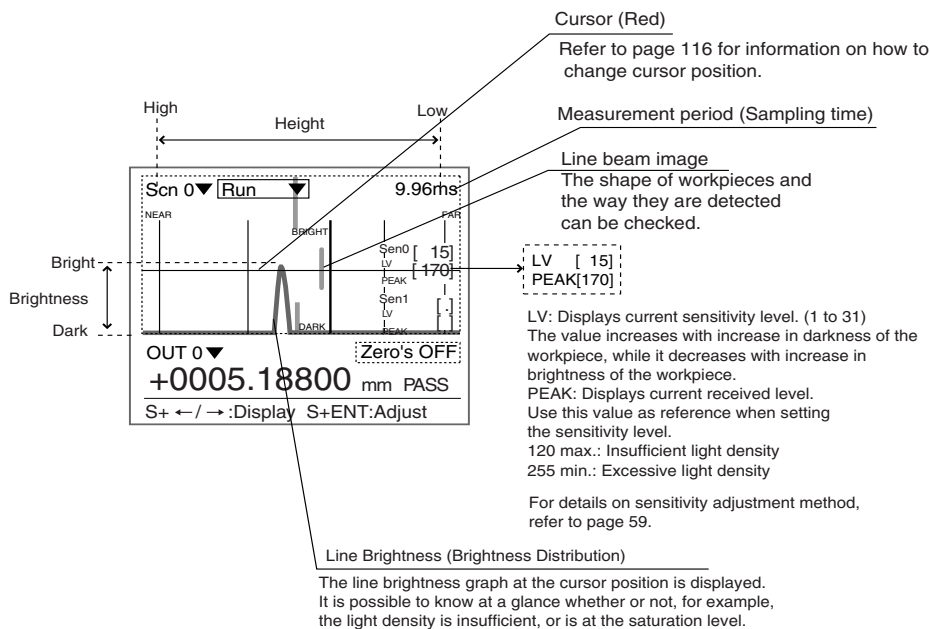

The line brightness graph for the specified range can be enlarged.



Refer to page 113.

Measurement Result Display

Check whether the measurements are correctly performed.
The measurement points and the measurement values are displayed.

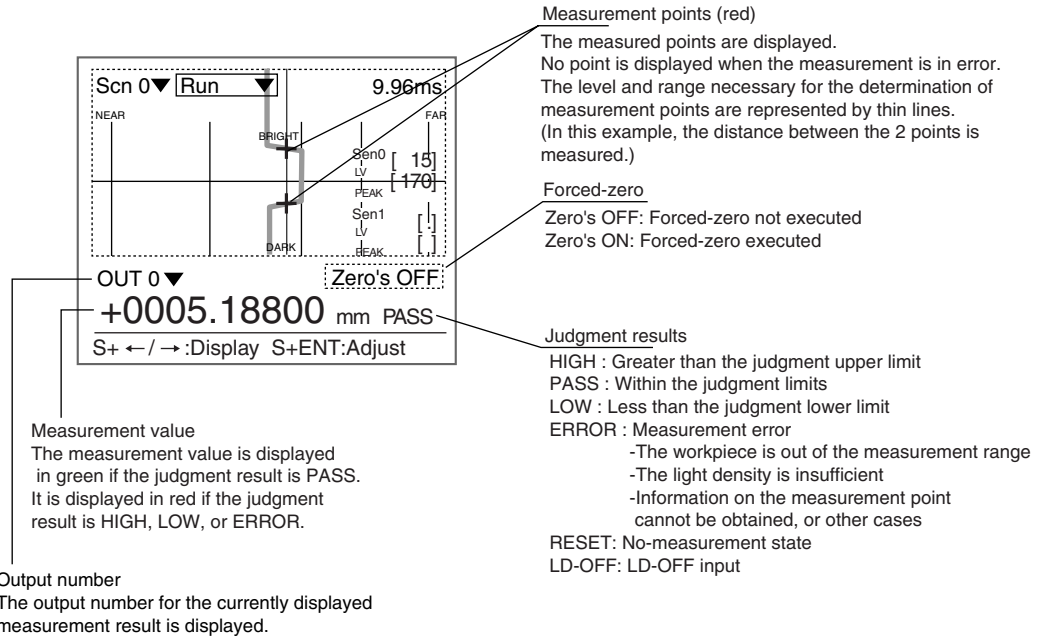

CHECK

Offset can be set for Force-zero.



REFERENCE

Refer to page 84.

2-3-2 Profile Monitor

Use to check the status of the workpiece surface.

Surface condition of a workpiece can be monitored on a shaded 3-D image screen. Height information and its chronological change can also be monitored.

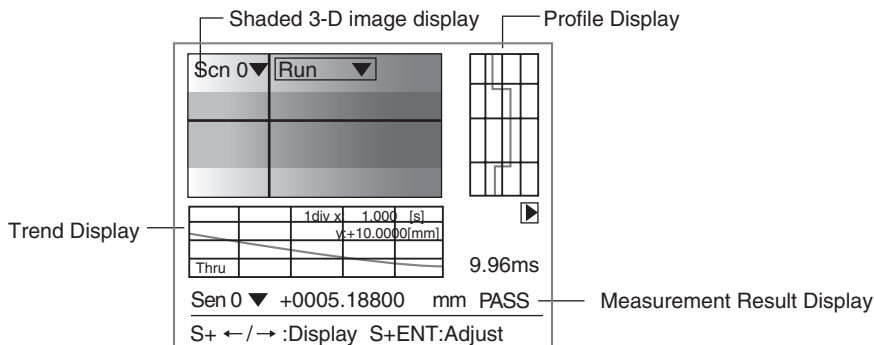

By moving the workpiece, the profile graph (height information for 126 points) can be monitored in chronological order for up to 10 seconds.

TRIG Key can be used for switching from waveform display to waveform display stop and vice versa. The trigger function enables shaded 3-D image to be displayed at specified timing.

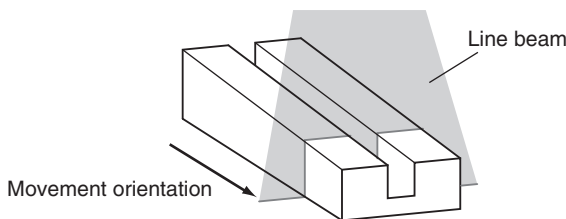

CHECK

Display range and display time can be changed.



REFERENCE

Refer to page 121.

Shaded 3-D Image Display and Profile Display

Surface condition of a workpiece is displayed by a shaded 3-D image with 0 to 255 gradations. A low section is displayed darkly, while a higher section is displayed brightly.

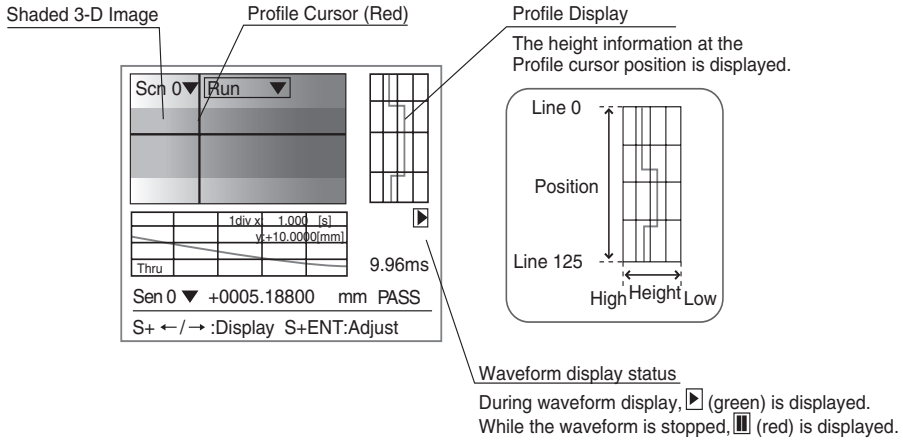

Trend Display and Measurement Result Display

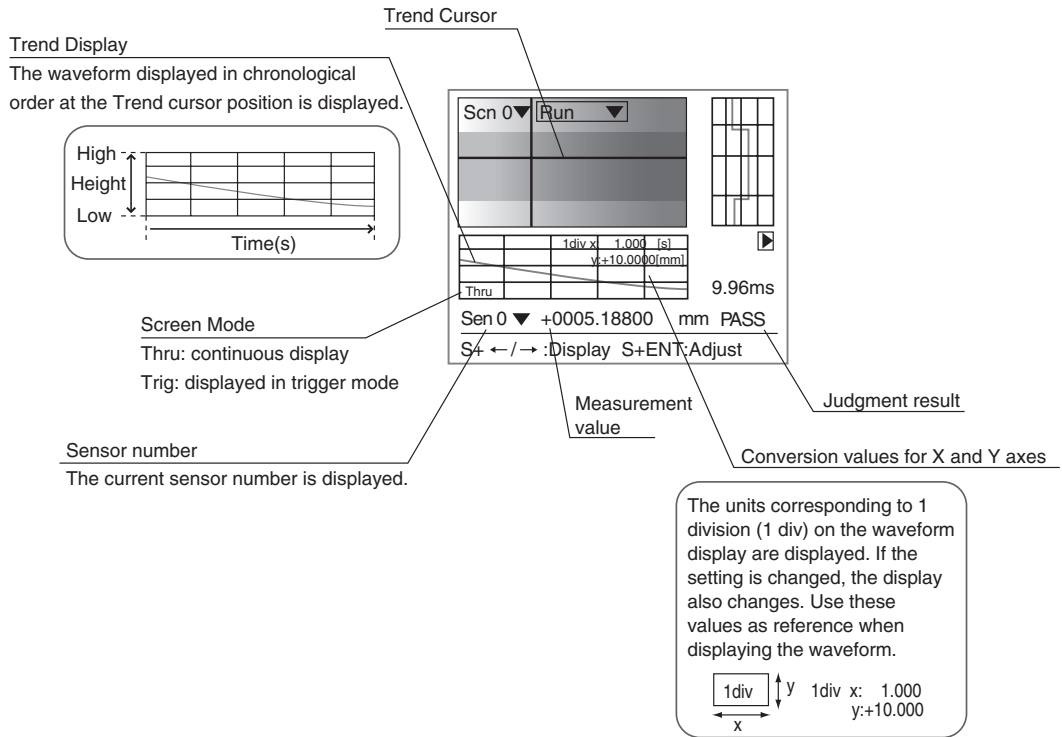

The cursor position can be changed.



Refer to page 121.

2-3-3 Digital Monitor

Mostly used during line operation.

Two or more measurement results that have been set for the output numbers of the displayed scenes will be displayed.

Output number
Press the **TRIG** Key to switch the number.

Scn 0	Run	9.96ms
0	+0002.65432mm PASS	HI=+0010.00000 LO=-0010.00000
1	+0004.65432mm PASS	HI=+0010.00000 LO=-0010.00000
2	+0000.00000mm ERROR	HI=+0010.00000 LO=-0010.00000
3	-----mm	HI=+0010.00000 LO=-0010.00000

S+ ← / → :Display S+ENT:Adjust

Judgment value
The judgment value for each output number will be displayed.
HI: Judgment upper limit
LO: Judgment lower limit

Measurement value

Judgment result

---- will be displayed for output numbers that have not been set.



Scn 0	Run	9.96ms
4	+0002.65432mm PASS	HI=+0010.00000 LO=-0010.00000
5	+0004.65432mm PASS	HI=+0010.00000 LO=-0010.00000
6	+0000.00000mm ERROR	HI=+0010.00000 LO=-0010.00000
7	-----mm	HI=+0010.00000 LO=-0010.00000

S+ ← / → :Display S+ENT:Adjust



CHECK

The measurement items can also be displayed instead of the judgment values.



REFERENCE

Refer to page 117.

Scn 0	Run	9.96ms
0	+0002.65432mm PASS	Step: 2 pts
1	+0004.65432mm PASS	Width
2	+0000.00000mm ERROR	Define
3	-----mm	

S+ ← / → :Display S+ENT:Adjust

Measurement items

2-3-4 Trend Monitor

Mostly used for setting and checking the Trigger function.

By using the Trend Monitor, the measurement results to be monitored can be checked in chronological order for up to 30 seconds. Press the **TRIG** Key to switch from waveform display to waveform display stop and vice versa. The trigger function enables waveform to be displayed at specified timing.

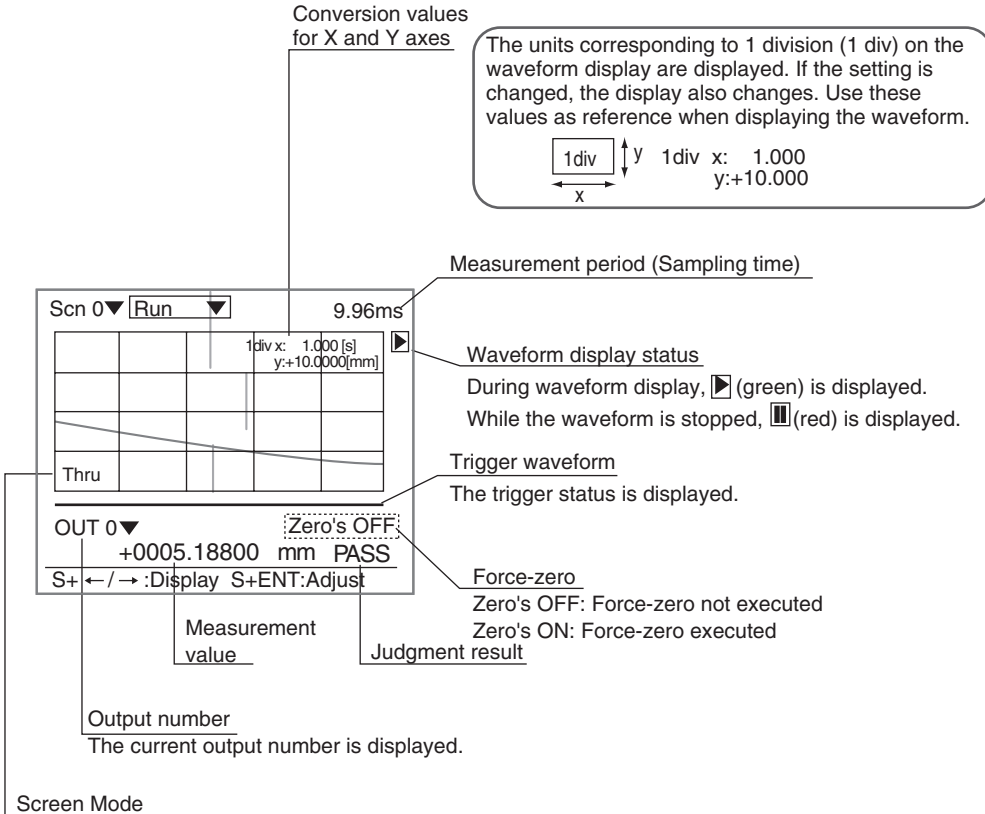

Thru: The waveform obtained by the Sensor is displayed continuously.
 Trig: A still image of the waveform based on the trigger settings is displayed.
 Thin lines are used to represent the measurement start and measurement end timings.



CHECK

Display range and display time can be changed. (Only the display range can be changed for each output number.)



REFERENCE

Refer to page 118.



CHECK

Characteristic quantities (such as average value and peak value being held) at specified timing can be output.



REFERENCE

Refer to page 84.

2-4 Saving Settings and Exiting the Z500

When settings have been changed, be sure to save to flash memory before turning the power OFF.



NOTICE

Flash memory data is loaded each time the Z500 is started up. Therefore, when settings have been changed, be sure to save to flash memory before turning the power OFF. If the power is turned OFF without saving, all of the setting changes will be lost.

1. Display the screen for Run Mode.

2. Move the cursor to **Run** and press the ENT Key.

A list of modes will be displayed.

3. Select **Save**.

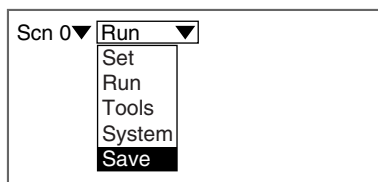

A confirmation message will be displayed.

4. Select **Execute**.



NOTICE

Do not turn OFF the power or input a RESET signal while a message is being displayed in any save or load operation. Data in memory will be destroyed, and the Z500 may not operate correctly the next time it is started.

When the saving has been completed, the screen in (3.) will return.

5. Turn OFF the power supply and exit the Z500.

MEMO

SECTION 3

Menus for Conversational Menu

SECTION 3 explains how to set measurement conditions using the Conversational Menu.

3-1	Setting Measurement Conditions Using the Conversational Menus	40
Step 1	Starting Conversational Menus	40
Step 2	Setting Basic Measurement Conditions	41
Step 3	Setting Measurement Contents	48
Step 4	Setting Measurement Conditions	49
Step 5	Setting Output Contents	50
Step 6	Starting Measurements	51
3-2	Saving Settings and Exiting the Z500	52

3-1 Setting Measurement Conditions Using the Conversational Menus

This section explains the procedures for using Conversational Menus, from setting measurement conditions through to starting measurement.

The operating guides displayed on the screen can be used just like a conversation to help perform procedures.

Step 1 Starting Conversational Menus

1. The screen shown right will be displayed when the Conversational Menus are started for the first time.
2. Move the cursor to **Run** and press the ENT Key.

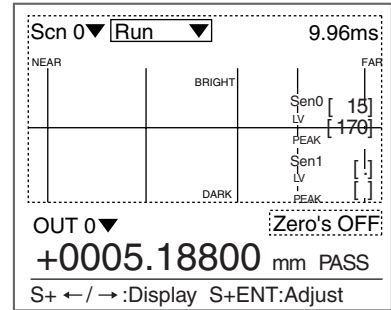

The mode selections will be displayed.

3. Use the **Up** and **Down** Keys to move the cursor and select **Set**.

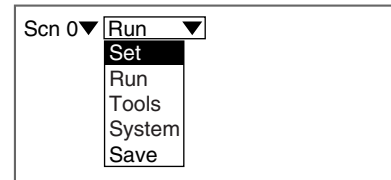

The Z500 will enter Set Mode.

4. Select **Next** to start making the settings.

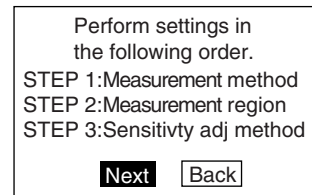

Follow the instructions given by the operation guide displayed on the screen for the rest of the procedure.



Two Sensor

The selections for the sensors to be used for measurement will be displayed. Select the Sensor number.

Step 2 Setting Basic Measurement Conditions

Basic settings required for measurement are described below.

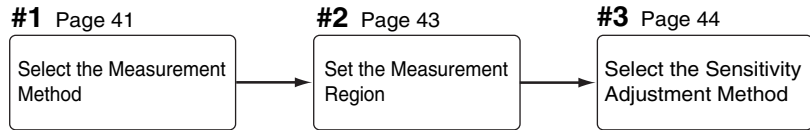

#1 Select the Measurement Method

Specify the region to be measured.

Select **Zoom** to assure higher position measurement accuracy.

Normally, use with the default setting (**Wide**).

Selection	Description
Wide*	Measures the whole measurement range of the connected sensor.
Zoom	Enlarges and measures a part of the measurement range of the connected sensor. Select this function to assure higher position measurement accuracy.

The asterisk (*) indicates the default setting.

Measurement range

Example: Z500-SW17

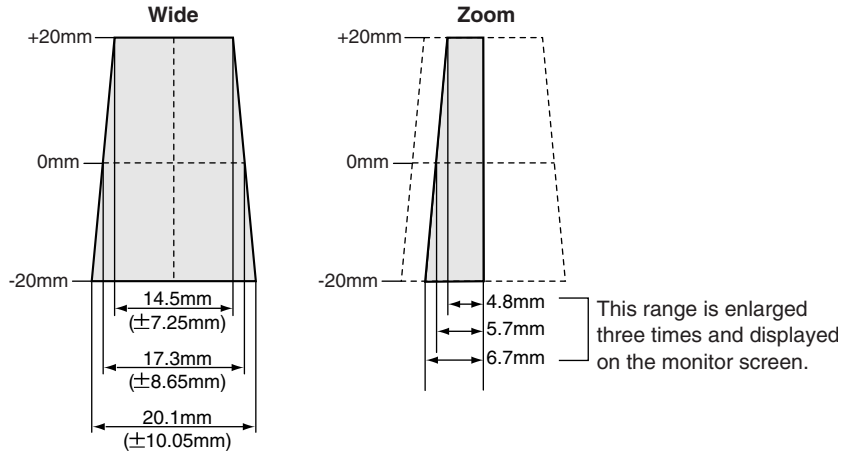

CHECK

The measurement range varies depending on the Sensor models connected.



REFERENCE

Refer to page 28 in the *Setup Manual*.

1. Select the measurement method while monitoring the image to be measured.
2. Press the **ENT** Key.

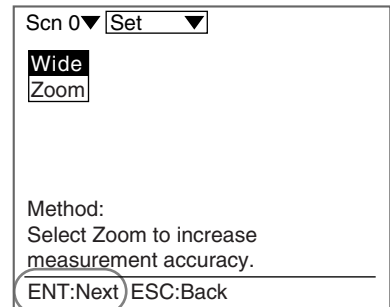

Go to #2.
Setting the Measurement Region.

Go to #2. *Setting the Measurement Region.*

#2 Setting the Measurement Region

Specify the region to be measured.

The Z500 adjusts sensitivity and performs measurements in a region that has been previously set. Though the whole image can be used for the measurement region, measurement accuracy can be raised by specifying a restricted measurement region.

Position the workpiece correctly and specify the measurement region.



Correct measurement may not be possible at the boundaries of the measurement regions. Leave space at the boundaries when setting the regions.

1. Position the workpiece correctly while monitoring the profile graph.
2. Press the **ENT** Key.

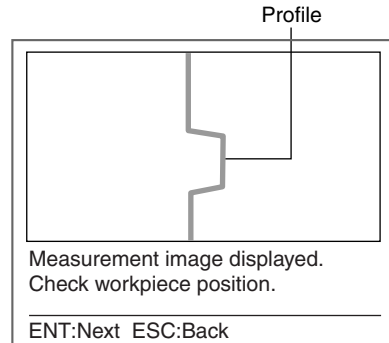

The screen for specifying the region will be displayed.

3. Specify the starting line of the measurement region.

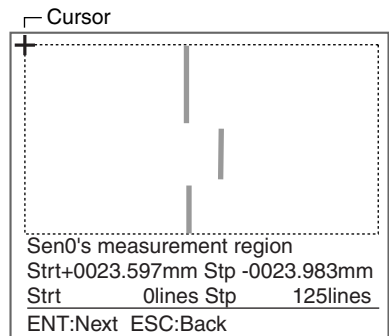

The cursor will be moved to the ending line.

4. Repeat the procedure described in (3.) to specify an ending line and press the **ENT** Key.

Go to #3. *Select the Sensitivity Adjustment Method.*

#3 Select the Sensitivity Adjustment Method

Select the sensitivity adjustment method for the measurement range.
If the measurement results fluctuate, change the adjustment method.
Normally, these conditions can be left at the default settings.

Sensitivity Adjustment

Selection	Description
Auto*	Adjust the sensitivity according to sensitivity information in the measurement region.
Fixed	The sensitivity can be set to one of 31 levels (Setting range: 0 to 31). Select when it is difficult to assure accurate measurement in Auto . Such cases may appear on a production line where workpieces of different colors are processed.
Multi	Adjust the sensitivity for each line in the measurement region. Select when it is difficult to assure accurate measurement in Auto due to a widely distributed brightness of the workpiece surfaces. However, sampling time will be longer. Position a reference workpiece and execute Multi . The Z500 will set automatically the upper and lower limits of sensitivity on the basis of the brightness of the reference workpiece.

The asterisk (*) indicates the default setting.



Once the sensitivity has been set in **Multi**, **Sensitivity** can be performed only through the adjustment menu.



Refer to page 28 for details on the adjustment menu, and page 63 for details on **Details**.

Sensitivity level (Displayed only when **Fixed** is selected from the Sensitivity Menu)

Setting range	Sensitivity	Color of workpiece
LV0 (See note)	—	—
LV1	Low	Bright
⋮	↓	↑
LV31	High	Dark

Note: The laser will turn OFF when selecting [LV0].

When selecting *Auto*

1. Select ***Auto***.

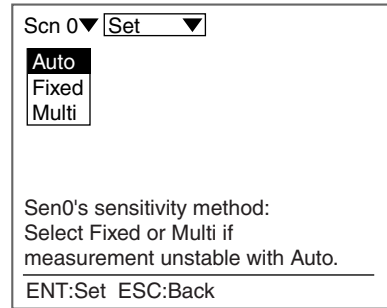

A confirmation message will be displayed.

2. Select ***Execute*** when the basic settings have completed.
Select ***Settings*** when continuing the measurement contents settings.

Go to **Step 3**.

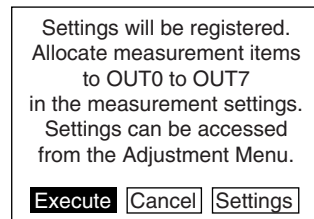

When selecting *Fixed*

1. Select **Fixed**.

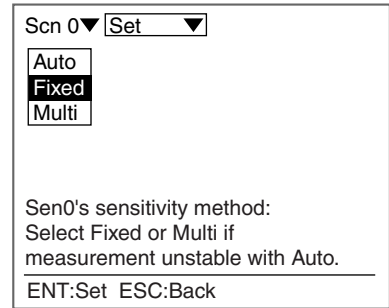

The screen for setting the sensitivity level will be displayed.

2. Select the level using the **Up** and **Down** Keys while monitoring the image on the monitor.
The level displayed first is the level selected by the Z500 for the workpiece being measured. Adjust the level while monitoring the line brightness graph and the received level on the monitor.
120 max.: Insufficient light density
255 min.: Excessive light density

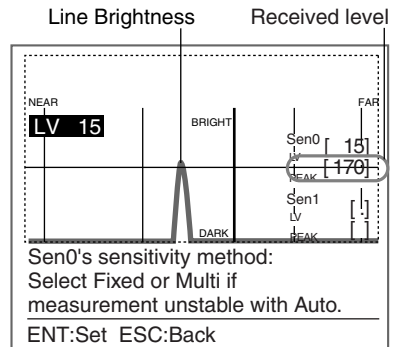

3. Press the **ENT** Key.

A confirmation message will be displayed.

4. Select **Execute** when the basic settings have completed.
Select **Settings** when continuing the measurement contents settings.

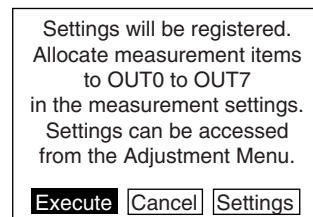

Go to **Step 3**.

When selecting *Multi*

1. Select **Multi**.

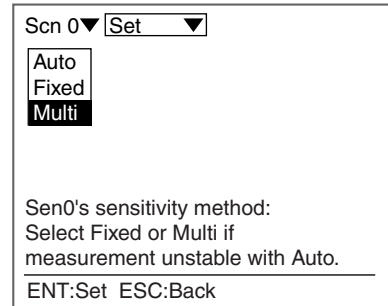

The sensitivity multiple setting screen will be displayed.

2. Check whether or not the workpiece is positioned inside the measurement range.
3. Press the **ENT** Key.

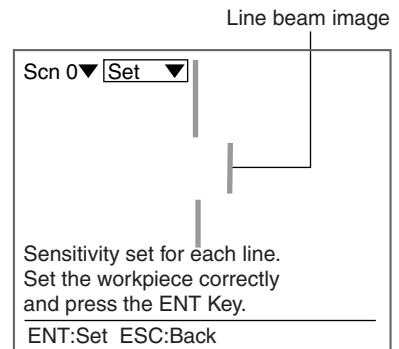

A confirmation message will be displayed.

4. Select **Execute** when the basic settings have completed.
Select **Settings** when continuing the measurement contents settings.

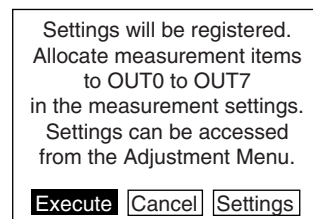

Go to **Step 3**.

Step 3 Setting Measurement Contents

The Z500 provides eight measurement items. Up to eight measurement items can be set for each scene. Select the measurement item according to application.

This section gives an outline only. Refer to SECTION 4 (page 70) for details on measurement contents.

 **REFERENCE**

Refer to page 70.

Step 4 Setting Measurement Conditions

Set the measurement conditions, such as average number of times and trigger setting.
Setting can be performed only through the adjustment menu.

 **REFERENCE**

Refer to page 28, *Adjustment Menu*.

This section gives an outline only. Refer to SECTION 4 (page 88) for details on measurement conditions.

 **REFERENCE**

Refer to page 88.

Step 5 Setting Output Contents

The Z500 can transmit data to an external device in three formats; analog, terminal, and RS-232C. The operation procedures for setting the output contents to the external device will be described in SECTION 4. Setting can be performed only through the adjustment menu.

 **REFERENCE**

Refer to page 28, *Adjustment Menu*.

This section gives an outline only. Refer to SECTION 4 (page 100) for details on output contents.

 **REFERENCE**

Refer to page 100.

Step 6 Starting Measurements

Perform the measurement under the conditions that have been previously set.
Use the following procedure to execute measurement according to the conditions set for the scene currently displayed.
The data will be output to external devices as well.

1. Confirm that **Run** is selected.
If **Run** is not selected, press the **ESC** Key several times to switch the selection.

Measurement will be executed and the measurement results will be displayed on the screen. Check that measurement has been performed correctly.

The output number for the currently displayed measurement result is displayed.

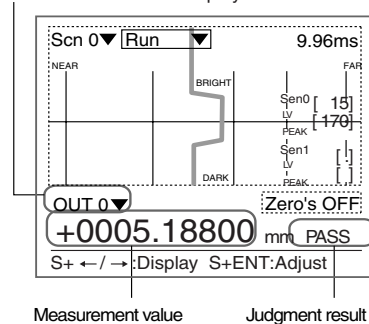

CHECK

Conditions can be changed simply without leaving Run Mode using the adjustment menu.
Measurement will be interrupted while adjustments are made.



REFERENCE

Refer to page 28.



CHECK

Change the Monitors using the **SHIFT + Right** Keys or **SHIFT + Left** Keys if necessary.



REFERENCE

Refer to page 29.



CHECK

For measurements through the execution of Force-zero



REFERENCE

Refer to page 110.

3-2 Saving Settings and Exiting the Z500

When settings have been completed, be sure to save to flash memory before turning the power OFF.

Refer to SECTION 2 (page 37) for details on saving settings.

 **REFERENCE**

Refer to page 37.

 **NOTICE**

Flash memory data is loaded each time the Z500 is started up. Therefore, when setting have been changed, be sure to save to flash memory before turning the power OFF. If the power is turned OFF without saving, all of the setting changes will be lost.

SECTION 4

Menus for Expert Menu

This section explains how to set measurement conditions using the Expert Menu.

4-1	Setting Measurement Conditions Using the Expert Menus	54
Step 1	Starting Up Expert Menu and Entering Set Mode	54
Step 2	Adjusting Images	56
Step 3	Position Compensation	64
Step 4	Measurement Settings	70
Step 5	Measurement Conditions	88
Step 6	Output Settings	100
Step 7	Performing Measurement	107
4-2	Saving Settings and Exiting the Z500	108

4-1 Setting Measurement Conditions Using the Expert Menu

This section explains how to set measurement conditions using the Expert Menu and the basic steps before starting measurements.

Step 1 Starting Up Expert Menu and Entering Set Mode

To set the measurement conditions, it is first necessary to enter Set Mode.

1. Move the cursor to **Run** ▼ and press the **ENT** Key.



Scn 0 ▼ Run ▼

A list of modes will be displayed.

2. Select **System**.

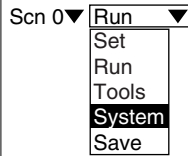

Scn 0 ▼ Run ▼
Set
Run
Tools
System
Save

The selections will be displayed.

3. Select **Environment**.

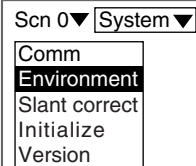

Scn 0 ▼ System ▼
Comm
Environment
Slant correct
Initialize
Version

The screen for setting environment will be displayed.

4. Move the cursor to **Conversatn** and press the **ENT** Key.

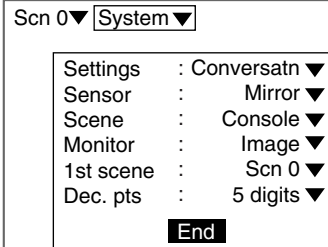

Scn 0 ▼ System ▼

Settings	:	Conversatn ▼
Sensor	:	Mirror ▼
Scene	:	Console ▼
Monitor	:	Image ▼
1st scene	:	Scn 0 ▼
Dec. pts	:	5 digits ▼

End

The selections will be displayed.

5. Move the cursor to **Expert** and press the **ENT** Key.
6. Select **End**.

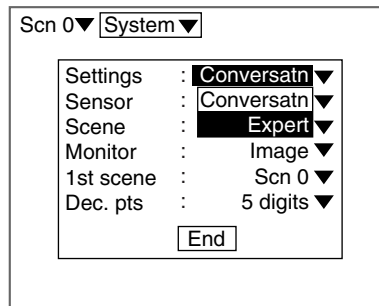

The setting will be registered and the screen in (3.) will return.

7. Press the **ESC** Key.

The screen in (2.) will return.

8. Select **Set**.

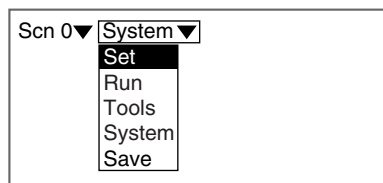

The selections available with the Expert Menu's Set Mode will be displayed.

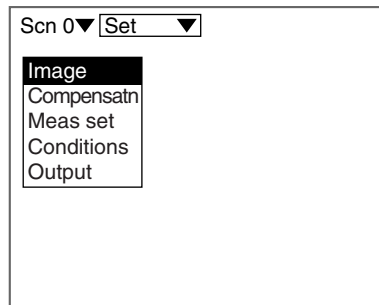

Step 2 Adjusting Images

To facilitate accurate measurements, images are adjusted for clearer display of the section to be measured.

Measurement Methods

Specify the region to be measured.

Select **Zoom** to assure higher position measurement accuracy.

Normally, use with the default setting (**Wide**).

Selection	Description
Wide*	Measures the whole measurement range of the connected sensor.
Zoom	Enlarges and measures a part of the measurement range of the connected sensor. Select this function to assure higher position measurement accuracy.

The asterisk (*) indicates the default setting.



CHECK

When the measurement method is changed, all settings for scene data will be cleared.

Measurement Range

Example: Z500-SW17

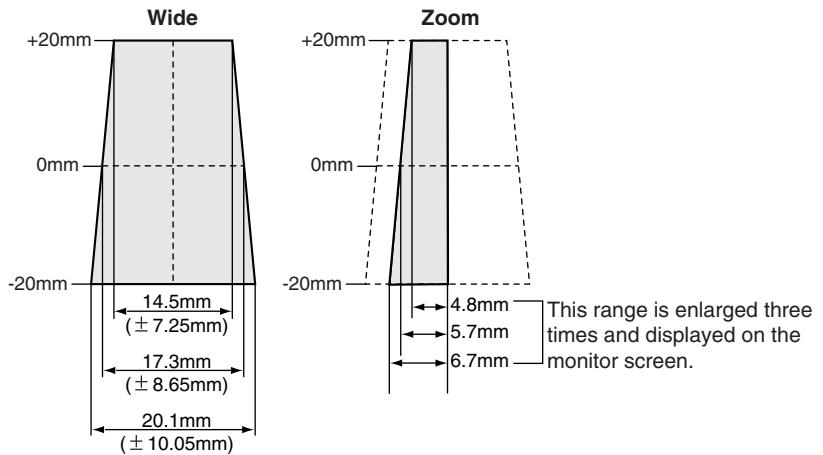

CHECK

The measurement range varies depending on the Sensor models connected.



REFERENCE

Refer to page 28 in the *Setup Manual*.

1. Select *Image/Meas Method*.

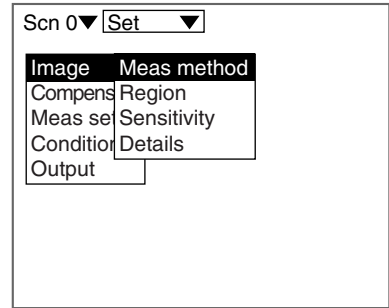

The measurement method selections will be displayed.



Two Sensor

The selections for the sensors to be used for measurement will be displayed.
Select the Sensor number.
Go to (2.).

2. Select the measurement method while monitoring the image to be adjusted.
3. Press the **ENT** Key.

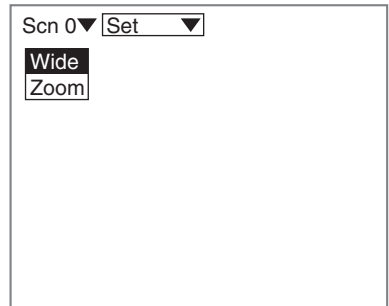

The setting will be registered and the screen in (1.) will return.

Setting Measurement Region

Specify the region to be measured.

The Z500 adjusts sensitivity and performs measurements in a region that has been previously set. Though the whole image can be used for the measurement region, measurement accuracy can be raised by specifying a restricted measurement region.



Correct measurement may not be possible at the boundaries of the measurement regions. Leave space at the boundaries when setting the regions.

1. Select **Image/Region**.

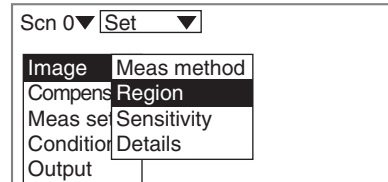

The screen for specifying the region will be displayed.

2. Specify the starting line of the measurement region.

Move the cursor with the **Up** and **Down** Keys.
(Use these keys together with the **SHIFT** Key to move the cursor quickly.)

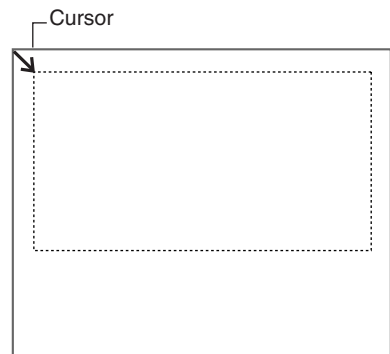

The cursor will be moved to the ending line.

3. Repeat the procedure described in (2.) to specify the ending line of the measurement region.

A confirmation message will be displayed.

4. Select **Execute**.

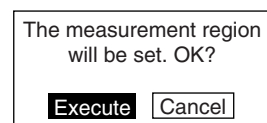

The setting will be registered and the screen in (1.) will return.

Sensitivity Adjustment

Select the sensitivity adjustment method for the measurement range.
If the measurement results fluctuate, change the adjustment method.
Normally, these conditions can be left at the default settings.



CHECK

The setting can be performed through the adjustment menu.



REFERENCE

Refer to page 28.



Two Sensor

Select the Sensor number to be used for measurement.

Sensitivity Adjustment

Selection	Description
Auto*	Adjust the sensitivity according to sensitivity information in the measurement region.
Fixed	The sensitivity can be set to one of 31 levels (Setting range: 0 to 31). Select when it is difficult to assure accurate measurement in Auto . Such cases may appear on a production line where workpieces of different colors are processed.
Multi	Adjust the sensitivity for each line in the measurement region. Select when it is difficult to assure accurate measurement in Auto due to a widely distributed brightness of the workpiece surfaces. However, sampling time will be longer. Position a reference workpiece and execute Multi . The Z500 will set automatically the upper and lower limits of sensitivity on the basis of the brightness of the reference workpiece. After the settings have been completed, fine adjustment can be made on Details .  REFERENCE Refer to page 63.

The asterisk (*) indicates the default setting.

Sensitivity level (Displayed only when **Fixed** is selected from the Sensitivity Menu)

Setting range	Sensitivity	Color of workpiece
LV0 (See note)	—	—
LV1	Low	Bright
⋮	↓	↑
LV31	High	Dark

Note: The laser will turn OFF when selecting [LV0].

When selecting *Auto*

1. Select **Image/Sensitivity**.

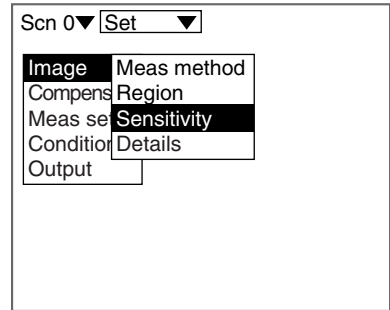

The selections for sensitivity adjustment will be displayed.



2. Select ***Auto***.

The setting will be registered and the screen in (1.) will return.

When selecting *Fixed*

1. Select *Image/Sensitivity*.

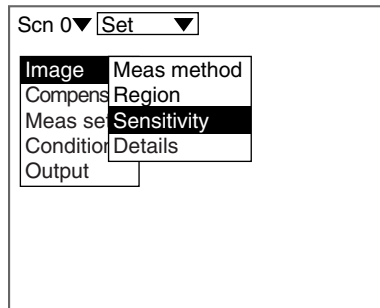

The selections for sensitivity adjustment will be displayed.



2. Select *Fixed*.

The screen for setting the sensitivity level will be displayed.

3. Select the level using the **Up** and **Down** Keys while monitoring the image on the monitor.

The level displayed first is the level selected by the Z500 for the work-piece being measured. Adjust the level while monitoring the line brightness graph and the received level on the monitor.

120 max. : Insufficient light density
255 min. : Excessive light density

4. Press the **ENT** Key.

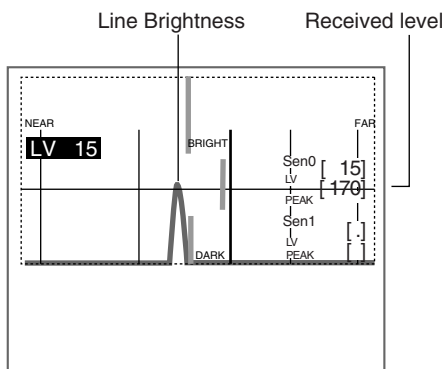

The setting will be registered and the screen in (1.) will return.

When selecting *Multi*

1. Select *Image/Sensitivity*.

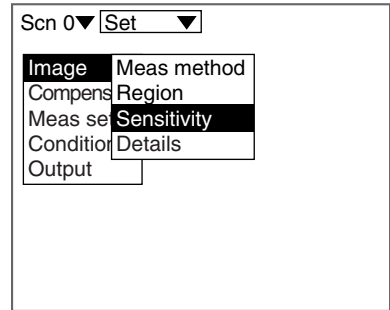

The selections for sensitivity adjustment will be displayed.

2. Select *Multi*.



The sensitivity multiple setting screen will be displayed.

3. Check whether or not the workpiece is positioned inside the measurement range and press the **ENT** Key.

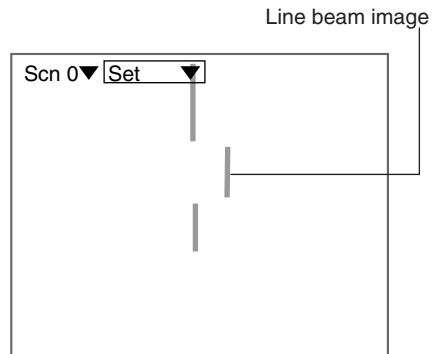

The setting will be registered and the screen in (1.) will return.

Details

Use this function to measure transparent workpieces. This function is also useful to shorten the response time in **Sensitivity/Multi**. Normally, these conditions can be left at the default settings. After changing the settings, perform a workpiece measurement to check that measurement can still be performed correctly.

Item	Selecion/ Setting range	Description
Surface	Frnt* Back	The reflecting surface for which sensitivity adjustment is performed is selected. To measure the back side of a transparent workpiece, select Back . Normally (i.e., when measuring opaque workpieces), this setting can be left as Frnt .
Upper	0 to 31(31*)	Specify the range to be adjusted the sensitivity.
Lower	0 to 31(1*)	This function is effective when sensitivity adjustment method is set to Auto or Multi . If the adjustment range is small, the response time for switching sensitivity will be short.
Gradations	120 to 220(170*)	Set the target gradation for sensor sensitivity adjustment.

The asterisk (*) indicates the default setting.



CHECK

The setting can be performed through the adjustment menu.



REFERENCE

Refer to page 28.

1. Select **Image/Details**.

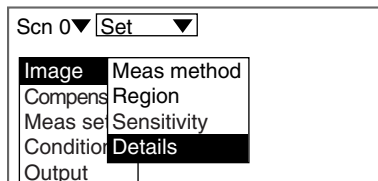

The setting screen for sensitivity details will be displayed.

2. Make the settings for each item.
3. Select **End**.

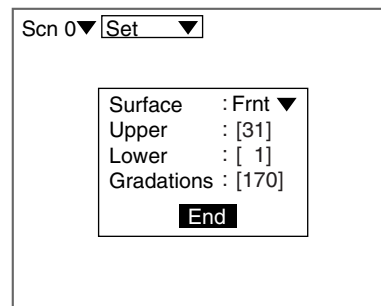

The setting will be registered and the screen in (1.) will return.

Step 3 Position Compensation

The position compensation function is used when the position of the measurement workpieces are not consistent.

By using this function, the displacement between the reference position and the current position is obtained, and this displacement is compensated for in measurements. Compensation can be made for both height and position.

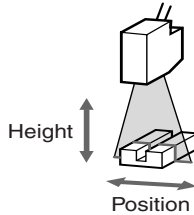

• **Reference Position**

The measurement range and measurement workpiece are in the correct positions.

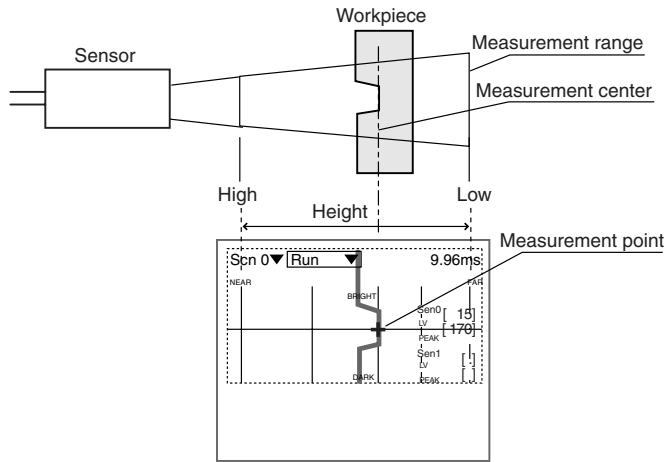

• **When the Position of the Workpiece is Lower**

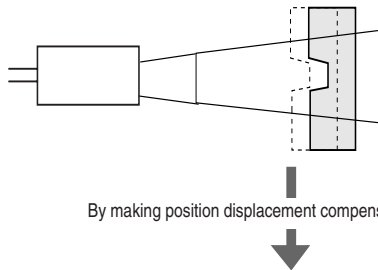

By making position displacement compensation settings ...

For measurement, compensate the height based on the displacement of the reference position.

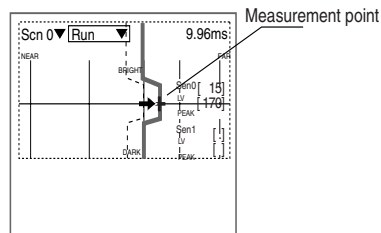

Operational Flow

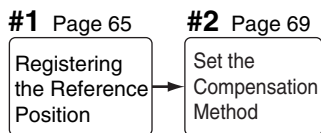

CHECK

To use the position compensation function, set **Compensatn** and **Meas set** in this order.

#1 Registering the Reference Position

Register the position to be used for a reference for position compensation. Before setting the necessary items, place the workpiece at the correct position. In the example provided below, the procedure for compensating under the following conditions is explained.

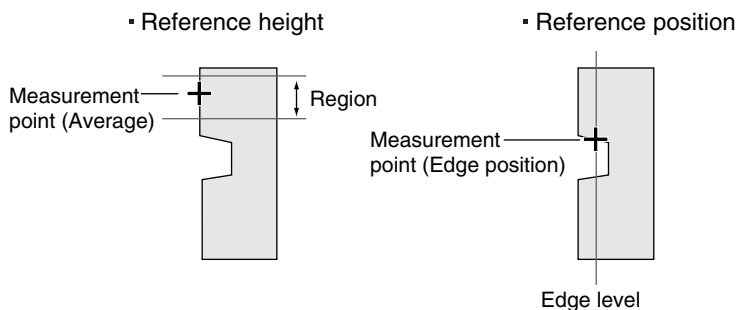

Reference height measurement point

Selection	Description
Average	Define the average profile position within a specified region as the measurement point.
Peak	Define the peak profile position within a specified region as the measurement point.
Bottom	Define the bottom profile position within a specified region as the measurement point.

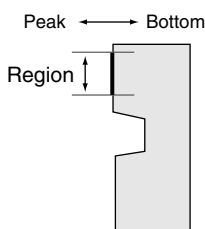

1. Select **Compensatn.**

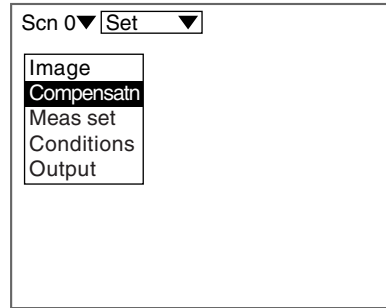

The selection for position compensation will be displayed.

2. Select **Reference.**

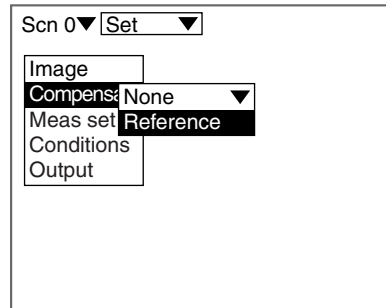

A profile graph will be displayed.

3. Check whether or not the workpiece is positioned correctly and press the **ENT** Key.

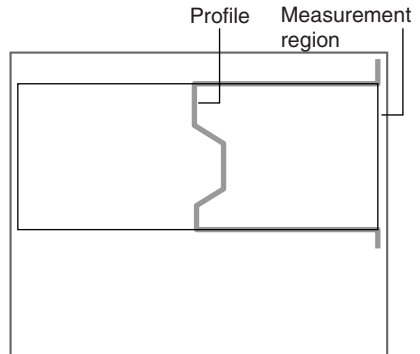

The screen for setting the reference height will be displayed.

4. Specify the starting line of the reference height region.

Use the **Up** and **Down** Keys to move the cursor.
(Use these keys together with the **SHIFT** Key to move the cursor quickly.)

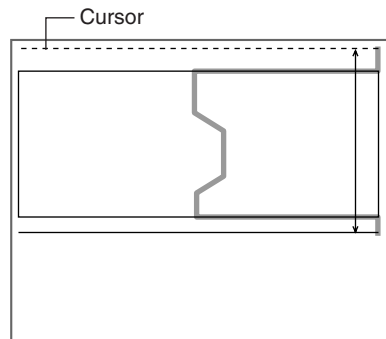

The ending-line setting screen will be displayed.

5. Specify the ending line of the reference height region.

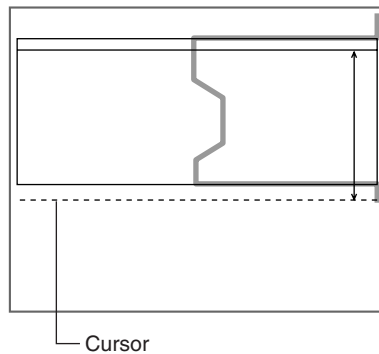

The characteristic quantity setting screen will be displayed.

6. Select a characteristic quantity that can be used as the measurement point of the reference height.

The cross cursor of the measurement point will move in response to the selections.
Select the item while monitoring the image.
In this example, select **Average**.

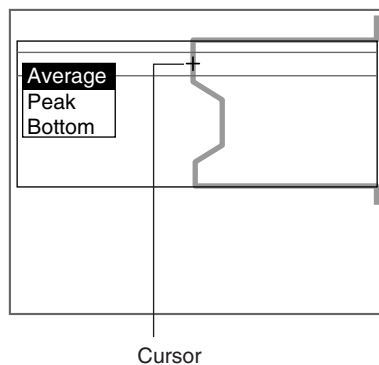

The setting screen for reference position will be displayed.

7. Specify the edge level to be used for the reference position.

Use the **Left** and **Right** Keys to move the cursor.
(Use these keys together with the **SHIFT** Key to move the cursor quickly.)

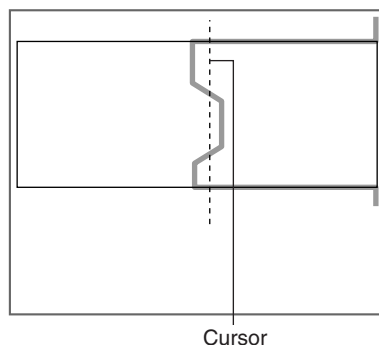

A cross cursor to be used for specifying the reference height will be displayed.

8. Use the **Up** and **Down** Keys to select the measurement point of the reference position.

The cursor of the measurement point is moved.
Select the measurement point while monitoring the image.

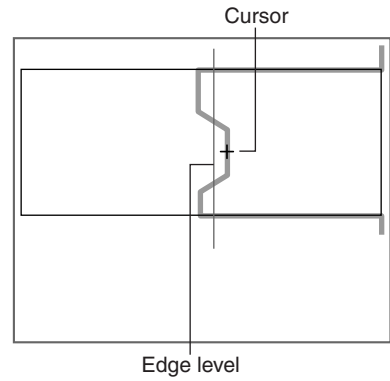

A confirmation message will be displayed.

9. Select **Execute**.

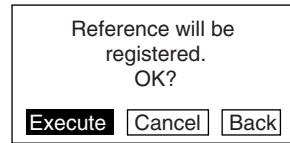

The setting will be registered and the screen in (2.) will return.

#2 Set the Compensation Method

Select the position compensation method.

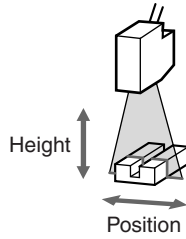

Selection	Description
None*	No compensation is required.
Height	Compensate the height.
Position	Compensate the position.
Height&Pos	Compensate both the height and position.

The asterisk (*) indicates the default setting.



Unless **Reference** has been set, the compensation method selections will not be displayed.

1. Move the cursor to **None** ▾ and press the **ENT** Key.

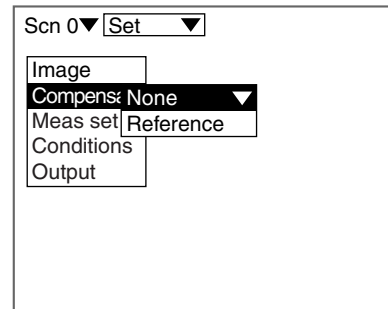

The selection for compensation method will be displayed.



2. Select the compensation method.
In this example, select **Height&Pos**.

The setting will be registered and the screen in (1.) will return.

Step 4 Measurement Settings

Set the measurement contents. Operational flow varies depending on the measurement item. Setting **Step: 2 pts**, **Edge position**, and **Define** are taken as examples for description.

Operational Flow

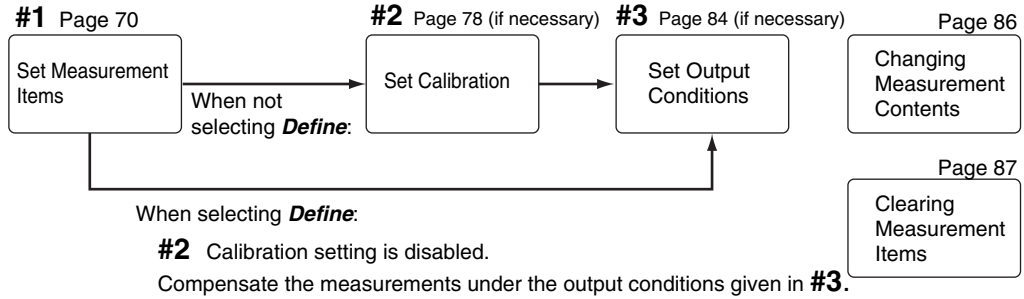

CHECK

To use the position compensation function, set **Compensatn** and **Meas set** in this order.



CHECK

The settings can be performed through the adjustment menu.



REFERENCE

Refer to page 28.

#1 Set Measurement Items

Up to eight measurement contents can be set for each scene.



There are 8 types of the measurement item. Different measurement item can be set for each output number.

Types of Measurement Item

Selection	Description	Symbol
Height*	Measure the height within the specified region.	
Step: 2 pts	Specify two measurement regions. After taking the measurement point within the 1st region as the reference, measure the distance from the measurement point in the 2nd region. REFERENCE Refer to page 72.	
Step: 3 pts	Specify three measurement regions. After taking the average of the measurement points within the two regions specified above, measure the difference from the measurement point in the 3rd region.	
Edge position	Measures the specified edge position. REFERENCE Refer to page 74.	

*Height is set in **OUT0** as the default setting.

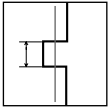
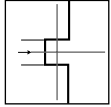
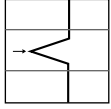
Types of Measurement Item (Continued)

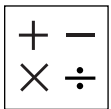
Selection	Description	Symbol
Width	Measure the difference between the specified two edge positions.	
Edge center	Based on the specified two edge positions, measure the center.	
Peak/bottom	Measure the peak or bottom point of the height within the specified region.	
Define	Using the equation, set the measurement items. The measurement result for an output number can be assigned to the equation.  REFERENCE Refer to page 76.	

*Height is set in **OUT0** as the default setting.

Characteristic Quantity of Measurement Points

Selection	Description
Average	Define the average profile position within a specified region as the measurement point.
Peak	Define the peak profile position within a specified region as the measurement point.
Bottom	Define the bottom profile position within a specified region as the measurement point.
Back	Set the back side of the workpiece for the measurement point. This procedure is effective when glass sheets and other transparent workpieces are measured.

• Peak and Bottom

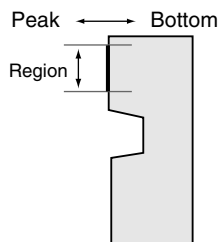

• Back

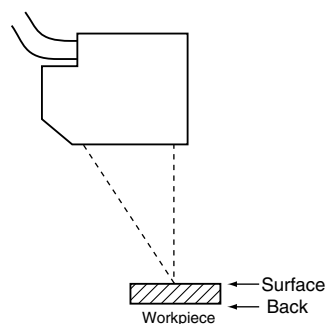

Step: 2 pts

Level differences, grooves, etc. of workpieces are measured.

The following conditions will be taken as an example for describing the setting procedures.

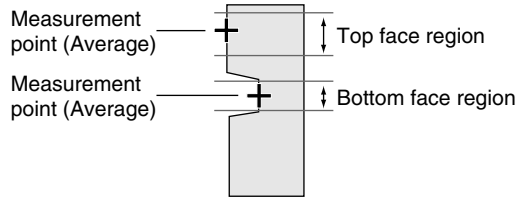

1. Select **Meas set**.

Scn 0 ▼ Set ▼

Image
Compensatn
Meas set
Conditions
Output

A list of output numbers will be displayed.

2. Select the output number for which **Step: 2 pts** is set.
In this example, Select **OUT1**.



Height is set in **OUT0** as the default setting. To set an item other than **Height** in **OUT0**, delete the existing measurement item.

 **REFERENCE**

Refer to page 87.

Scn 0 ▼ Set ▼

OUT0:Height
OUT1:
OUT2:
OUT3:
OUT4:
OUT5:
OUT6:
OUT7:

The selection for measurement item will be displayed.

3. Select the measurement item.
In this example, select **Step: 2 pts**.

Measrmt item
Height
Step: 2 pts
Step: 3 pts
Edge position
Width
Edge center
Peak/bottom
Define

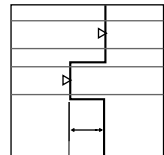

The setting screen for bottom face measurement region will be displayed.

4. Specify the starting line of the bottom face measurement region.
Move the cursor with the **Up** and **Down** Keys.
(Use these keys together with the **SHIFT** Key to move the cursor quickly.)

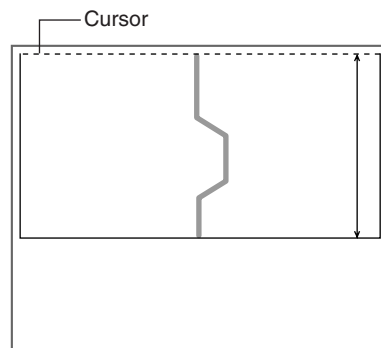

The ending-line setting screen will be displayed.

5. Repeat the procedure described in (4.) to specify the ending line of the bottom face measurement region.

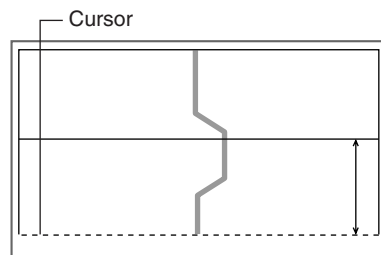

The characteristic quantity setting screen will be displayed.

6. Select a characteristic quantity that can be used as the measurement point of the bottom face.
The cross cursor of the measurement point will move in response to the selections.
Select the item while monitoring the image.
In this example, select **Average**.

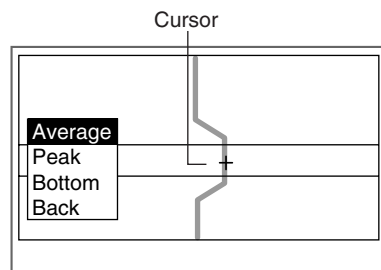

The setting screen for top face measurement region will be displayed.

7. Repeat (4.) through (6.) to set the characteristic quantities of the top face measurement region and measurement point.

A confirmation message will be displayed.

8. Select **Execute**.

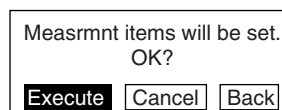

The setting will be registered and the screen in (2.) will return.

Edge position

Measures the edge position of the workpiece.

The following conditions will be taken as an example for describing the setting procedures.

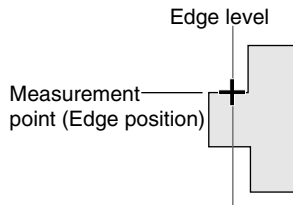

In this example, the intersection point of the edge level and the profile becomes the measurement point.

Set the edge level as follows.

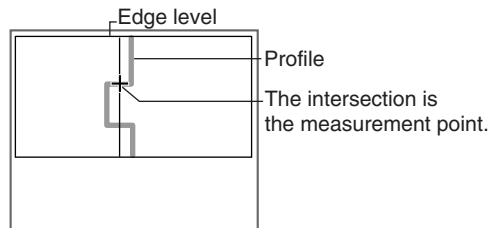

CHECK

The setting edge level and the measurement point can be checked on the Image Monitor.



REFERENCE

Refer to page 32.

1. Select **Meas set**.

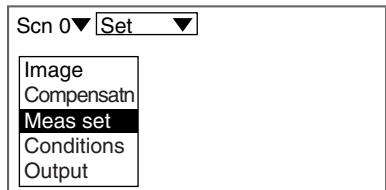

A list of output numbers will be displayed.

2. Select the output number for which **Edge position** is set.
In this example, select **OUT2**.



CHECK

Height is set in **OUT0** as the default setting. To set an item other than **Height** in **OUT0**, delete the existing measurement item.

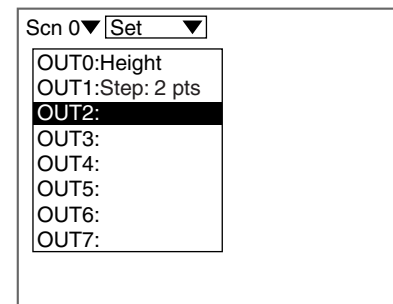

REFERENCE

Refer to page 87.

The selection for measurement item will be displayed.

3. Select the measurement item.
In this example, Select **Edge position**.

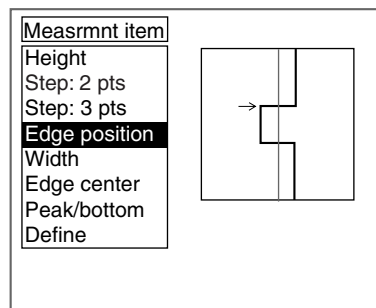

The setting screen for edge position will be displayed.

4. Specify the level to be measured as the edge.
Move the cursor with the **Left** and **Right** Keys.
(Use these keys together with the **SHIFT** Key to move the cursor quickly.)

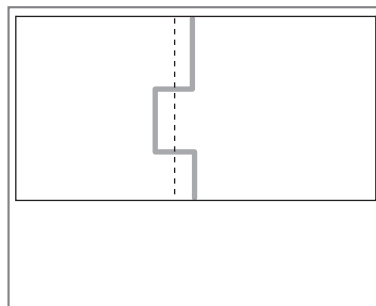

The setting screen for edge position will be displayed.

5. Specify the edge position regarded as the measurement point.
Move the cursor with the **Up** and **Down** Keys.



In some cases, the cursor will not be displayed on the intersection point of the edge level and the edge position. However, selection of an arbitrary cursor will give the same measurement result (the intersection point becomes the measurement point), as long as the selected cursor exists near the intersection point.

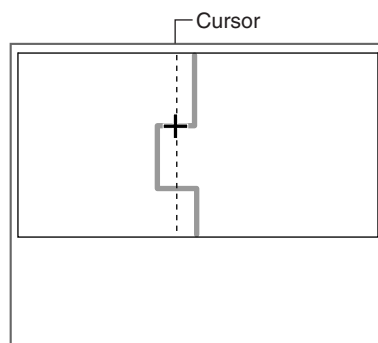

A confirmation message will be displayed.

6. Select **Execute**.

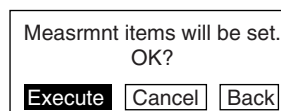

The setting will be registered and the screen in (2.) will return.

Define

Set the equation by using the measurement results for the output number.

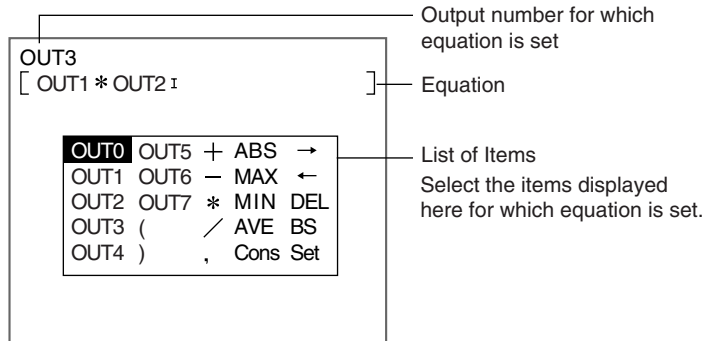

List of Items

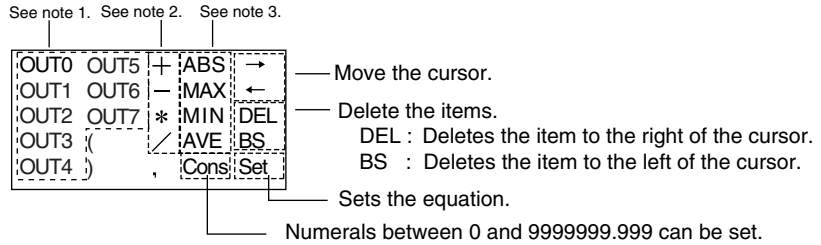

Note 1

- Output number

When this item is selected, equation can be performed by using the measurement results (results obtained after calibration) that have been set for the output number.



Any output number cannot be selected, unless its measurement items have been set.

Note 2

- Arithmetic Operators

Operator	Meaning
+	Addition
-	Subtraction
*	Multiplication
/	Real number division

Note 3

- Functions

Function	Description
ABS	Calculates the absolute value. ABS (argument)
MAX	Gives the largest value of arguments. MAX (Argument 1, Argument 2, Argument 3,...)
MIN	Gives the smallest value of arguments. MIN (Argument 1, Argument 2, Argument 3,...)
AVE	Calculates the average value of arguments. AVE (Argument 1, Argument 2, Argument 3,...)

1. Select **Meas set**.

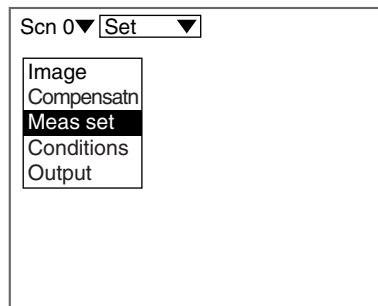

A list of output numbers will be displayed.

2. Select the output number for which **Define** is set.
In this example, select **OUT3**.



CHECK

Height is set in **OUT0** as the default setting. To set an item other than **Height** in **OUT0**, delete the existing measurement item.



REFERENCE

Refer to page 87.

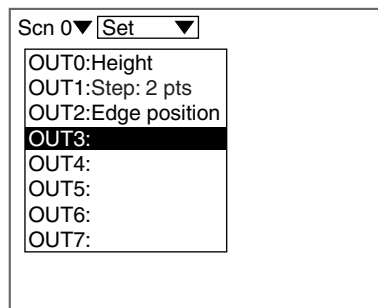

The setting screen for equation will be displayed.

3. Select the item from the list of items and set the equation.
4. Select **Set** when the equation has been set.

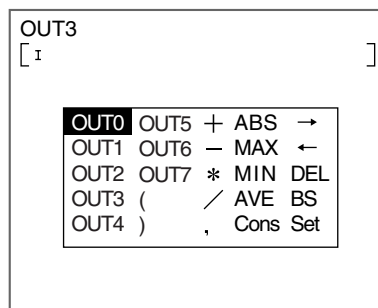

A confirmation message will be displayed.

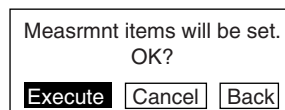

5. Select **Execute**.



The setting will be registered and the screen in (2.) will return.

#2 Set Calibration

Set calibrations to compensate the measurement values. Set calibrations to compensate for differences between measurement values and actual dimensions due to the color or material of the measurement workpiece. The setting method varies depending on the measurement items set for the output number.

Compensation	Measurement items	Description
Compensate the measured height and position.	Height, Edge position, Edge center, Peak/bottom	For setting, repeat the measurement twice.  REFERENCE Refer to page 78.
Compensate the measured level difference and width.	Step: 2 pts, Step: 3 pts, Width	For setting, repeat the measurement once.  REFERENCE Refer to page 81.



CHECK

Output can be used for fine adjustment after calibration setting. Use **Output** also to compensate the measurement values when **Define** has been selected for the measurement item.



REFERENCE

Refer to page 84.



CHECK

Refer to page 83 for information on how to clear calibration settings.

Compensate the Measured Height and Position

To compensate for the error, perform the measurement twice.

Applicable measurement items: Height, Edge position, Edge center, Peak/bottom

Example 1: When selecting **Height**

Workpiece height: 10 mm

Use the method shown below to calibrate workpieces so that a displacement value of 9.95 mm is measured as 10 mm.

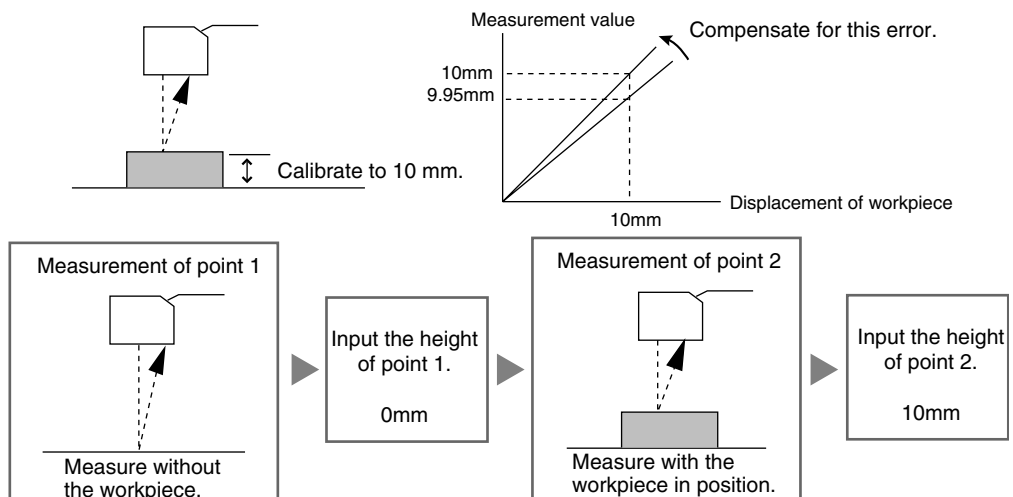

Example 2: When selecting *Edge position*

Movement distance from the edge position: 5 mm
Use the method shown below to calibrate workpieces so that a displacement value of 4.95 mm is measured as 5 mm.

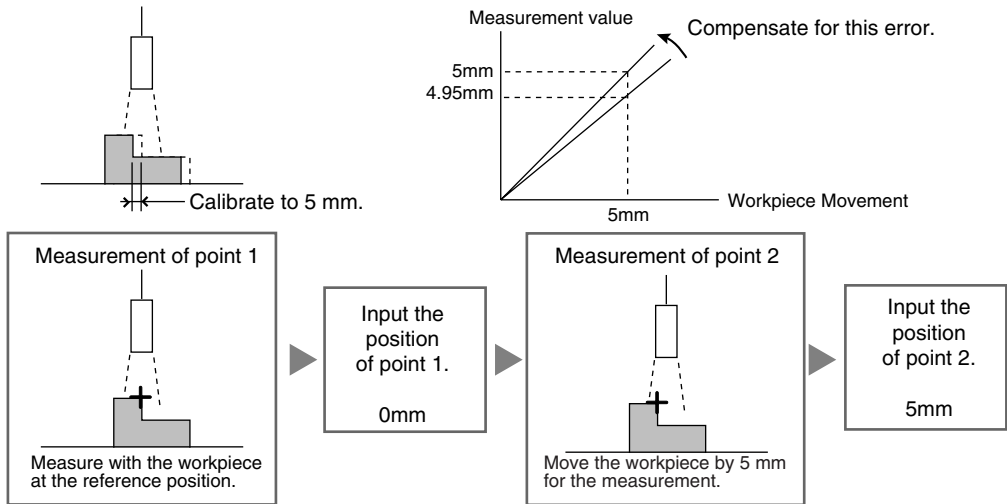

Height in Example 1 is taken here to describe the setting method.
Make the necessary adjustments when setting a different item.

1. Move the cursor to *Height* and press the ENT Key.

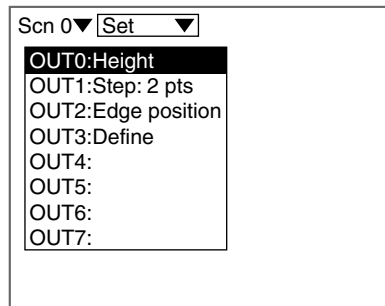

The selections will be displayed.

2. Select *Calibrate*.

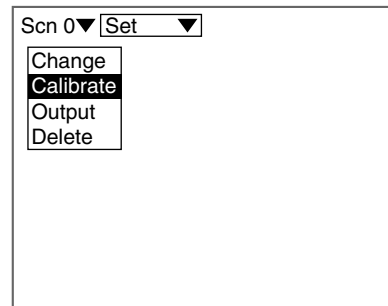

A confirmation message will be displayed.

- 3.** Select **Execute**.

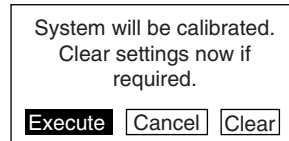

The measurement screen for point 1 will be displayed.

- 4.** Press the **ENT** Key without a workpiece in position.

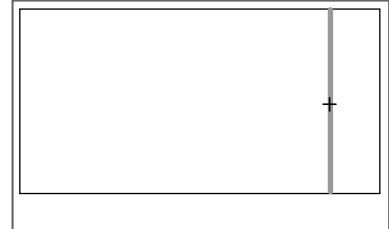

The screen for inputting the position of point 1 will be displayed.

- 5.** Set the value to 0.00000 and press the **ENT** Key.

00000.00000

The measurement screen for point 2 will be displayed.

- 6.** Position the workpiece correctly and press the **ENT** Key.

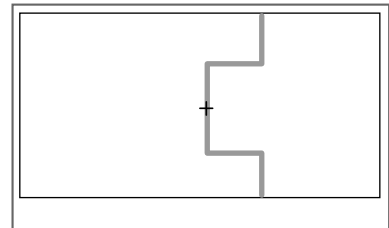

The screen for inputting the position of point 2 will be displayed.

- 7.** Set the value to 5.00000 and press the **ENT** Key.

00005.00000

A confirmation message will be displayed.

- 8.** Select **Execute**.

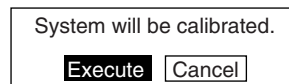

The setting will be registered and the screen in (2.) will return.

Compensate the Measured Level Difference and Width

To compensate for the error, perform the measurement once.
Applicable measurement items: Step: 2 pts, Step: 3 pts, Width

Example : When selecting **Step: 2 pts**

Level difference: 5 mm
Use the method shown below to calibrate workpieces so that a displacement value of 4.95 mm is measured as 5 mm.

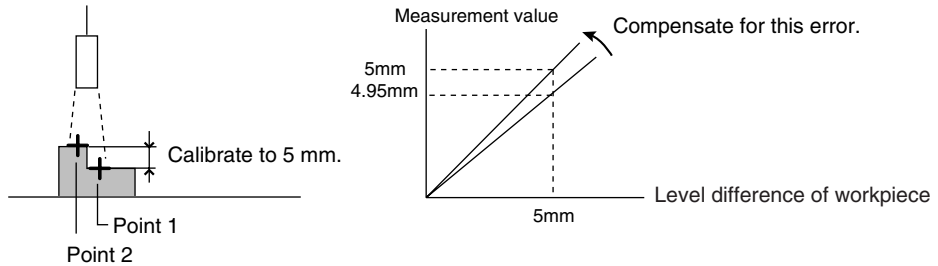

To compensate for this error, perform the measurement once.

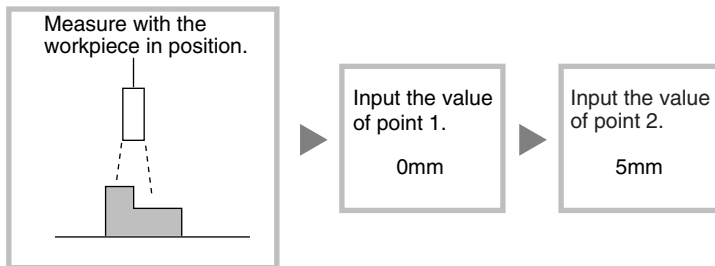

1. Move the cursor to **Step: 2 pts** and press the **ENT** Key.

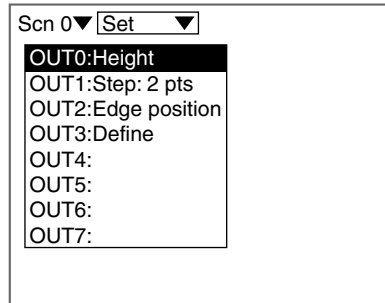

The selections will be displayed.

2. Select **Calibrate**.

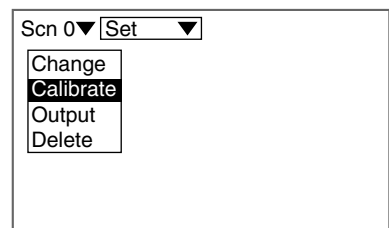

A confirmation message will be displayed.

- 3.** Select **Execute**.

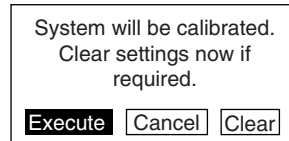

The measurement screen for point will be displayed.

- 4.** Position the workpiece correctly and press the **ENT** Key.

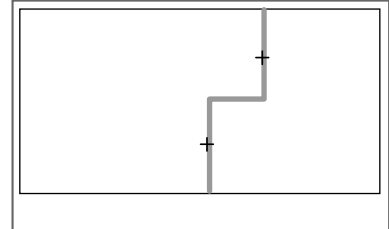

The screen for inputting the position of point 1 will be displayed.

- 5.** Set the value to 0.00000 and press the **ENT** Key.

00000.00000

The screen for inputting the position of point 2 will be displayed.

- 6.** Set the value to 5.00000 and press the **ENT** Key.

00005.00000

A confirmation message will be displayed.

- 7.** Select **Execute**.

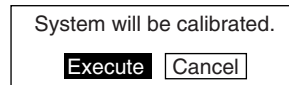

The setting will be registered and the screen in (2.) will return.

Clearing Calibration Settings

1. Move the cursor to the measurement item to be cleared and press the **ENT** Key.

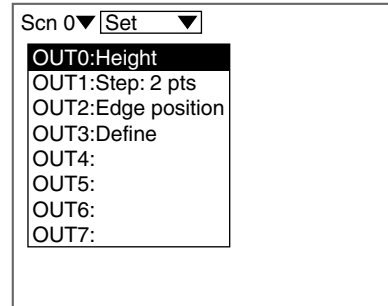

The selections will be displayed.

2. Select **Calibrate**.

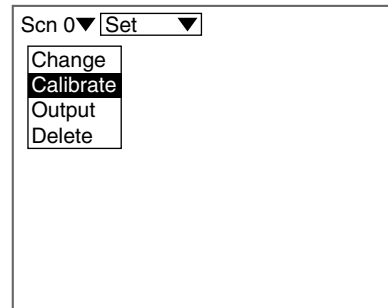

A confirmation message will be displayed.

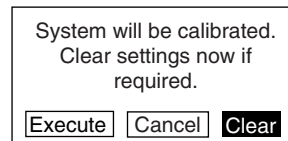

3. Select **Clear**.



The setting will be cleared and the screen in (2.) will return.

#3 Set Output Conditions

Set the output conditions of measurement results as necessary.

Item	Selection	Description
Upper	-9999.99999 to	Set the judgment conditions. Set the range for a PASS judgment.
Lower	9999.99999	
Hold		Set when the Trigger function is used. Select the contents of the data to be held.  REFERENCE For details on the Trigger function, refer to page 90.
	None*	Hold measurement is not performed.
	Sampling	The value at the start of measurement is held.
	Peak	The highest value measured during measurement is held.
	Bottom	The lowest value measured during measurement is held.
	Peak-Peak	The difference between the highest and lowest values measured during measurement is held.
	Average	The average value between the highest and lowest values measured during measurement is held.
Zero	-9999.99999 to 9999.99999	Set the offset value for force-zero execution. Set the value to be added to 0.  REFERENCE Refer to page 110, Force-zero.
Span	0.20000 to 4.00000 (1.00000*)	Set to make fine adjustments to measurement values after calibration. Set for the incline in the Sensor characteristics.
Offset	-9999.99999 to 9999.99999 (0.00000*)	Set to make fine adjustments to measurement values after calibration. Added to or subtracted from measurement values that have been set.
Unit	mm* mm ² None	Select the unit of the measured values to be displayed on the monitor screen.

The asterisk (*) indicates the default setting.

Span and Offset

- Span

A coefficient (the span) is set to compensate for incline in the Sensor characteristics.

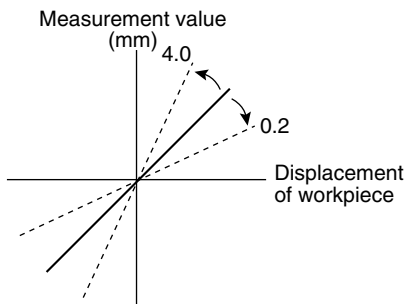

- Offset

A fixed value (the offset) is added to or subtracted from measurement values.

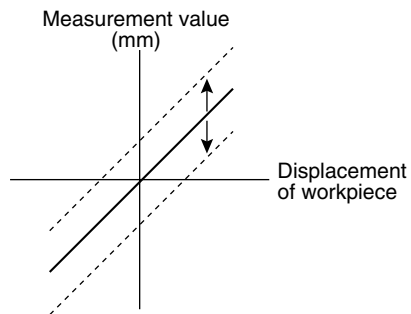

When calibration is executed, the span and the offset will be automatically set.

1. Move the cursor to the output number to be set the output conditions and press the **ENT** Key.

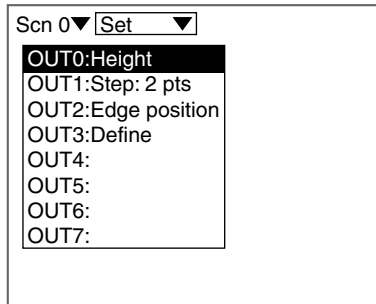

The selections will be displayed.

2. Select **Output**.

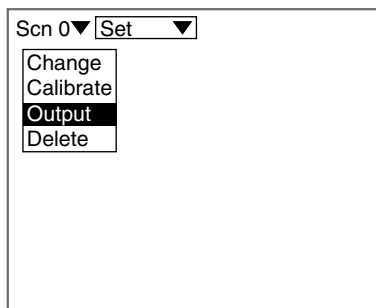

The setting screen for output conditions will be displayed.

3. Set the necessary items.
4. Select **End**.

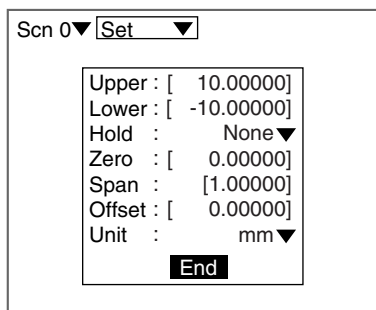

The setting will be registered and the screen in (2.) will return.

Changing Measurement Contents

Change the measurement contents that have been set for the output number.



To change measurement items, clear the existing measurement items and then set new items.



Refer to page 87.

1. Move the cursor to the output number to be changed the output conditions and press the **ENT** Key.

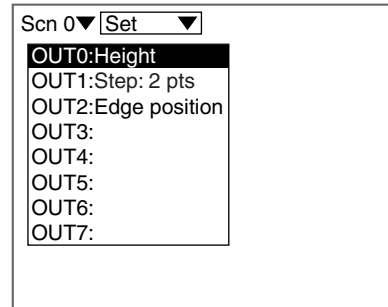

The selections will be displayed.

2. Select **Change**.

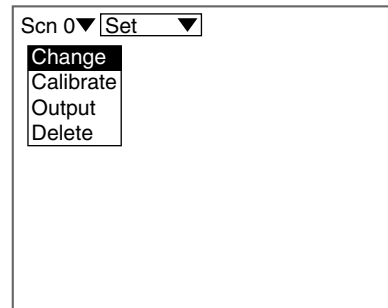

The setting screen for measurement range will be displayed.

The remaining procedures are the same as those for measurement item setting.

Clearing Measurement Items

Clear the measurement items that have been set for the output numbers.



Refer to page 127 for details on clearing separately for each scene.

1. Move the cursor to the output number to be cleared the output conditions and press the **ENT** Key.

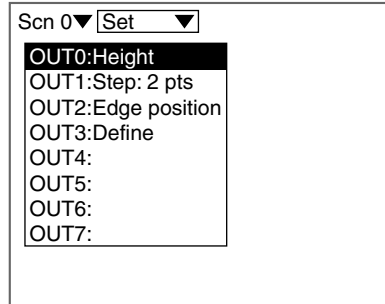

The selections will be displayed.

2. Select **Delete**.

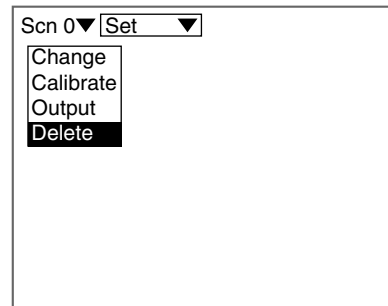

A confirmation message will be displayed.

3. Select **Execute**.

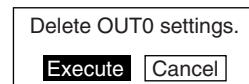

The measurement items for the selected output number are cleared off and the screen in (1.) will return.

Step 5 Measurement Conditions

Set the measurement conditions. The following can be set in **Conditions** and its lower hierarchies. Perform the setting as required.

Menu	Description	Reference
# to avg	The average of the setting number of times is output as the measurement result. Set this function to disregard sudden changes in the waveform.	Page 88.
Trigger	From the measurement results that have been obtained within a specified measurement period, the specified characteristic quantity is held and output.	Page 90.
Details	Removing noises, outputting measurement failure, and other miscellaneous methods can be set in more detail.	Page 96.

Averaging number

Use this function to disregard sudden changes in the waveform. The average of the setting number of times is output as the measurement result.

Selection	1, 2, 4, 8*, 16, 32, 64, 128, 256
------------------	-----------------------------------

The asterisk (*) indicates the default setting.

• The Relationship between the Measurement Response Time and the Resolution

Averaging number	Measurement response time	Resolution
1	Short	Low
⋮	↕	↕
256	Long	High



CHECK

The setting can be performed through the adjustment menu.



REFERENCE

Refer to page 28.

1. Select **Conditions**.

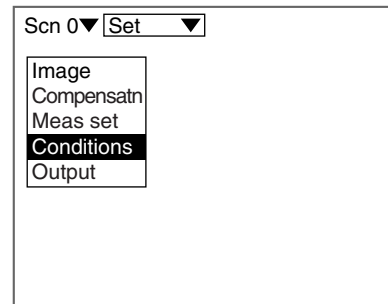

The selections will be displayed.

2. Select **# to avg**.

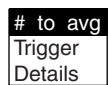

The setting screen for averaging number will be displayed.

3. Select averaging number.
4. Select **End**.

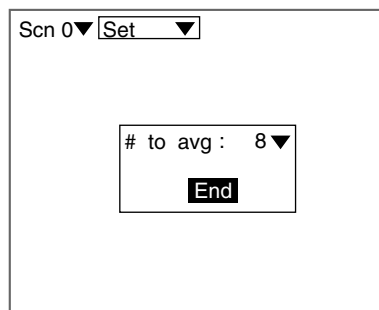

The setting will be registered and the screen in (2.) will return.

Trigger setting

Use the Trigger function to measure moving workpieces in chronological order. From the measurement results that have been obtained within a specified measurement period, the specified characteristic quantity is held and output. Use the procedure explained below to set the trigger input method.

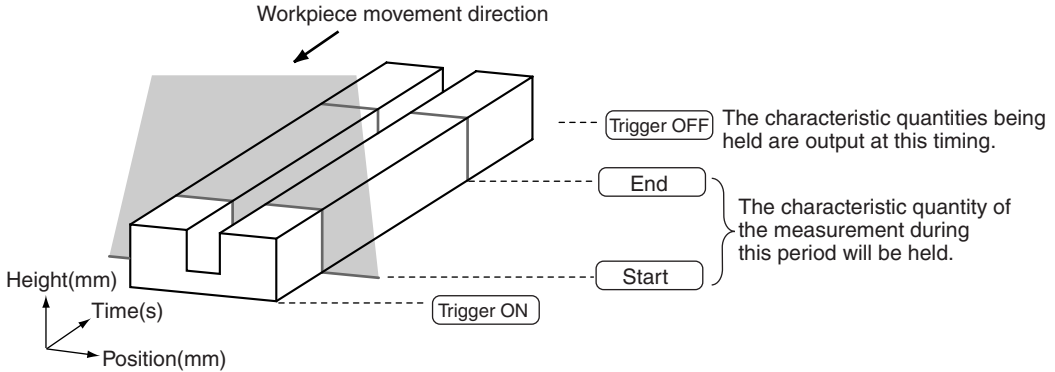

• Trigger Input Method

Selection	Description	
Free*	Measurement is performed continuously. Hold measurement is not performed.	
External	Select when using a sync sensor. The trigger turns ON at the same time as the TRIGGER terminal on the terminal block.	
Self	Up*	The trigger turns ON when the measurement value goes above the trigger level.
	Down	The trigger turns ON when the measurement value goes below the trigger level.

The asterisk (*) indicates the default setting.



Use **Output** to select the characteristic quantity that holds the measured values.



Refer to page 84.

The procedure for make trigger settings under the following details is explained below.

The difference between the maximum value and minimum value of the workpiece height is output.

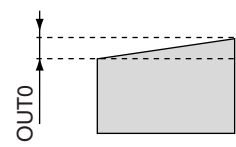

● Measurement item **OUT0:Height**

- Trigger input method **Self**
- Hold setting (see note) **Peak-Peak**

Note: Set the Hold setting by using **Meas set** in advance.

 Refer to page 84.

Operational Flow

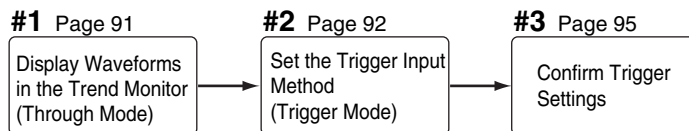

#1 Display Waveforms in the Trend Monitor

Use the waveform to decide the trigger level and to set the measurement start position.



CHECK

Set the screen mode to **Thru** in advance.



REFERENCE

Refer to page 118.

1. Press the **SHIFT + Right Keys** or **SHIFT + Left Keys** several times to switch to Trend Monitor.
2. Pass the workpiece under the Sensor and display the waveform.
3. The instant the waveform representing the workpiece is displayed, press the **TRIG** Key.

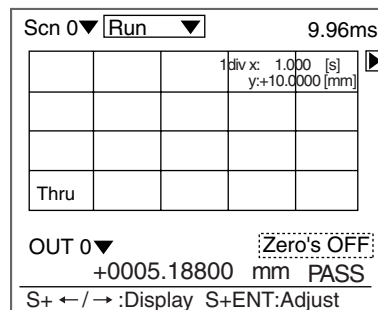

The waveform display is fixed.

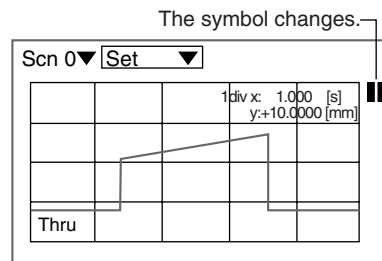

#2 Set the Trigger Input Method

Select the trigger input method, and set the trigger position and the trigger level.



CHECK

The setting can be performed through the adjustment menu.



REFERENCE

Refer to page 28.

1. Enter Set Mode and select **Conditions**.

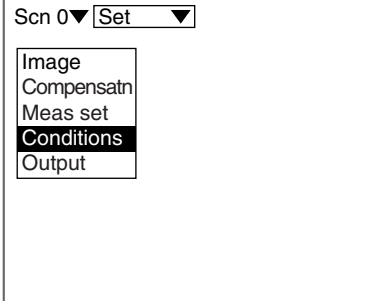

The selections will be displayed.

2. Select **Trigger**.

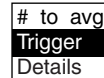

The selections for trigger input method will be displayed.

3. Select the trigger input method and press the **ENT** Key.
In this example, select **Self**.



The setting screen for trigger contents will be displayed.

4. Set each item.

In this example, select **Trigger** to **OUT0** and **Direction** to **Up**.
5. Select **Execute**.

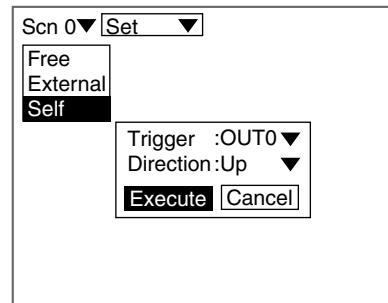

The trigger setting screen will be displayed.

The waveform set in #1 is displayed.

6. Specify the trigger-ON position and trigger level, and press the **ENT** Key.

Use the **Left** and **Right** Keys to specify the trigger position.

Use the **Up** and **Down** Keys to specify the trigger level.

Use these Keys together with the **SHIFT** Key to move the cursor quickly.

Trigger-ON position Trigger level

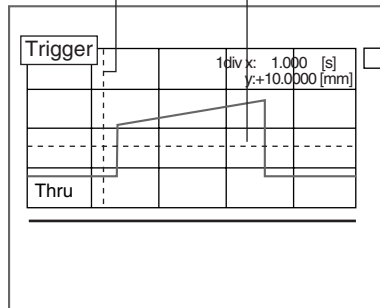

When the trigger turns ON, the waveform above the trigger level is displayed at a position based on the position set here.

Trigger Position in the Center

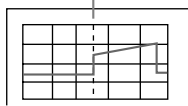

The waveform before and after the trigger turns ON can be monitored.

Trigger Position on the Left

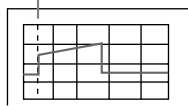

Mainly the waveform after the trigger turns ON can be monitored.

The trigger-OFF setting screen will be displayed.

7. Using the **Left** and **Right** Keys, specify the trigger-OFF position.

Use the **Left** and **Right** Keys together with the **SHIFT** Key to move the cursor quickly.

Trigger-OFF position

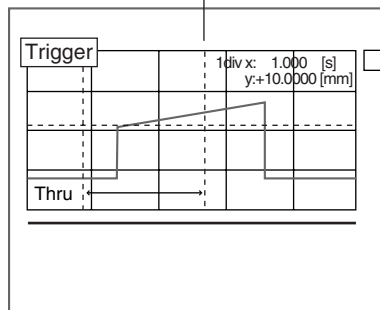

The setting screen for measurement start timing will be displayed.

8. Using the **Left** and **Right** Keys, specify the measurement starting position.

Use the **Left** and **Right** Keys together with the **SHIFT** Key to move the cursor quickly.

Measurement start position

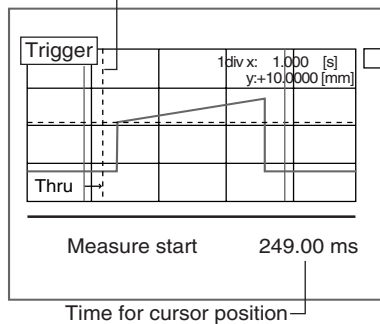

The time for cursor position (time after the trigger is turned ON) is displayed on the lower part of the screen. Refer this time for setting the measurement starting position.

The cursor will be moved to the measurement ending position.

9. Repeat the procedure described in (8.) to specify the measurement ending position.



The time for cursor position (time after the trigger is turned ON) is displayed on the lower part of the screen. Refer this time for setting the measurement ending position.

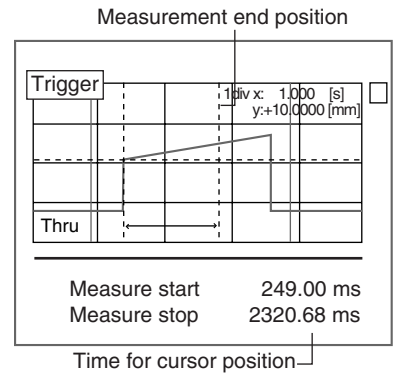

A confirmation message will be displayed.

10. Select **Execute**.

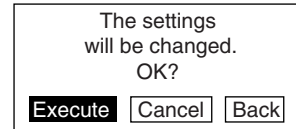

The setting will be registered and the screen in (2.) will return.

#3 Confirm Trigger Settings

Check if measurements are being correctly performed with the set trigger contents.

 **CHECK** Set the screen mode to *Trig* in advance.

 **REFERENCE**

Refer to page 118.

1. Press the **SHIFT + Right** Keys or **SHIFT + Left** Keys several times to switch to Trend Monitor.
2. Pass the workpiece under the Sensor.

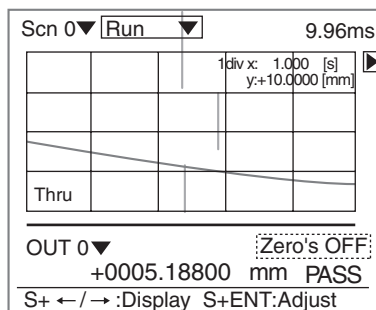

The waveform is displayed from the trigger position set in #2.

3. Perform a workpiece measurement several times to check that measurement can be performed correctly.

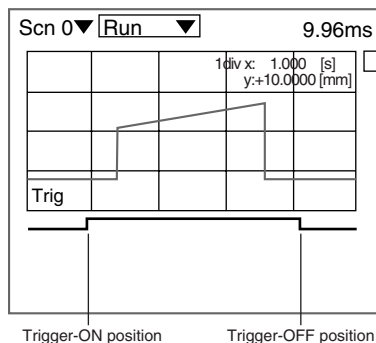

- When the measurement start and end positions have to be adjusted

Return to the procedure in #2, with the waveform kept displayed, and adjust the positions.

Details setting

Use the details setting when measurement cannot be performed correctly or when more accurate measurement is required.

1. Select **Conditions**.

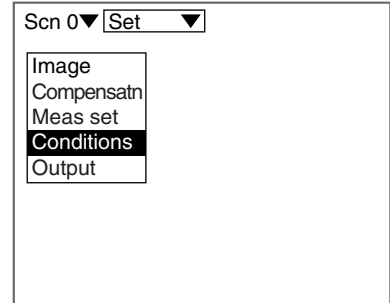

The selections will be displayed.

2. Select **Details**.

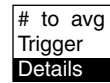

The setting screen for details will be displayed.

3. Make the settings for each item.

4. Select **End**.

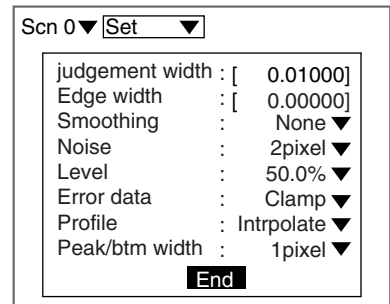

The setting will be registered and the screen in (2.) will return.

Judgment value hysteresis width (judgement width)

Set the hysteresis width for Judgment limits.

Setting range	0.00000 to 9999.99999
----------------------	-----------------------

The default setting varies depending on the Sensor connected.

Example: HI: 100.000 mm; LO: 80.000 mm
Judgment value hysteresis width: 0.05 mm

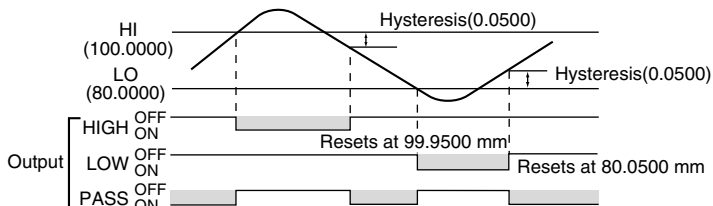

Edge Detection Hysteresis Width (Edge width)

Set the hysteresis width of edge detection.

Change the edge width when edge detection is unstable.

Setting range	0.00000 to 9999.99999 (0.00000*)
----------------------	----------------------------------

The asterisk (*) indicates the default setting.

Example: Edge level: 80.000 mm
Edge level hysteresis width: 0.0500 mm

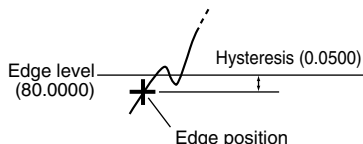

Smoothing (Smoothing)

Use this function to smooth the measured images.

Selection	Description
None	No smoothing.
Weak*	Smoothing is performed at a low level.
Strong	Smoothing is performed at a high level.

The asterisk (*) indicates the default setting.

Noise removal (Noise)

Other than images with a setting pixel will be regarded as noise and excluded from measurement.

Selection	0pixel, 1pixel, 2pixel, 3pixel, 4pixel*, 5pixel, 6pixel, 7pixel,
------------------	--

The asterisk (*) indicates the default setting.

Measurement Level (Level)

Change this when workpiece material fluctuation is too extensive to assure correct measurement. Set the measurement level of the measurement height (a percentage of the peak level of the line brightness). The default setting is 50.0%. Normally, use this setting.

Selection	12.5%, 25.0%, 37.5%, 50.0%*, 62.5%, 75.0%, 87.5%,
------------------	---

The asterisk (*) indicates the default setting.

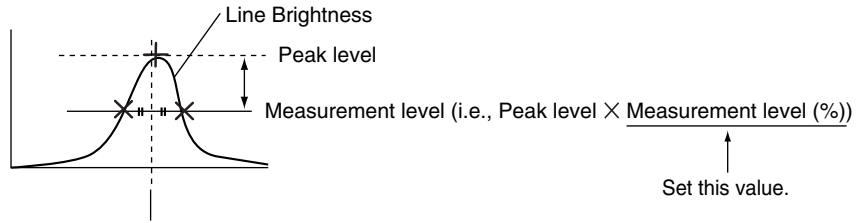

The intermediate point between the measurement level edges provides the height measurement result.

The peak measurement position can be adjusted by raising the measurement level.

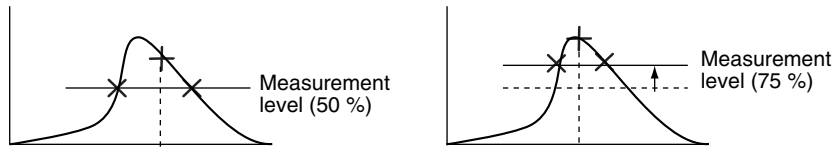

Error data (Error data)

In cases where the light density is temporarily excessive or insufficient (i.e., measurement is not possible) due to defects or holes in the workpiece, it is possible to set the Z500 to hold the previous data.

Selection	Description
Clamp*	An error is displayed and is output.
Hold	The value measured immediately before measurement became impossible is displayed and output.

The asterisk (*) indicates the default setting.

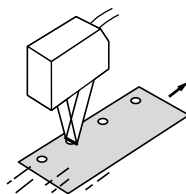

Operation with Clamp Setting

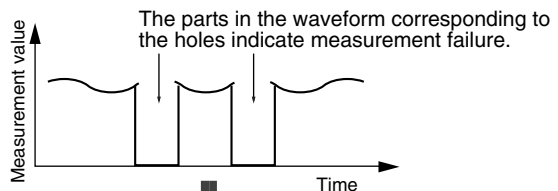

Operation with Hold Setting

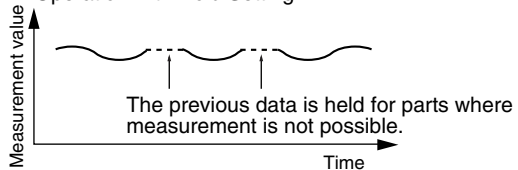

Contents of Display and Output

Display/Output		Hold	Clamp
Judgment results display		The previous status is held.	ERROR is displayed.
Terminals Judgment output (See note.)			ERROR is output.
RS-232C			Measurement error is output.
Analog Output	4-20mA		22mA min.
	±5V	+6V min.	

Note: The numbers of the output terminals vary depending on the output numbers.

Profile (Profile)

If there is a process line where the workpieces cannot be measured due to different reflectance or other causes, the data of such line can be obtained by interpolating the data acquired from the lines that allow measurement as desired.

Selection	Description
None	A measurement error signal is output for a portion interfering with the measurement.
Intrpolate*	For a portion interfering the measurement, measured values obtained before and after the error are interpolated and the result is output.

The asterisk (*) indicates the default setting.

Example: An output profile of a portion interfering with the measurement.

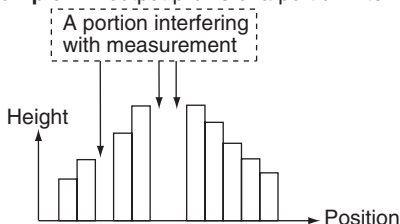

When selecting **None** :

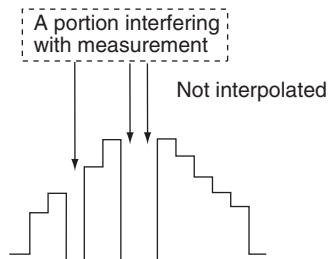

When selecting **Intrpolate** :

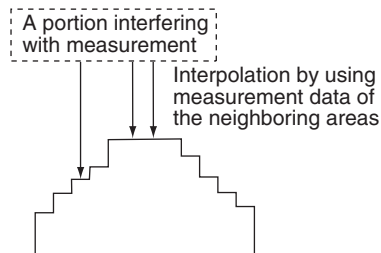

Peak/bottom Measurement Width (Peak/btm width)

The average over a specified region when measuring the peak or bottom is output as the measurement value. The region can be specified in pixel units. Setting a larger value will stabilize the measurement value.

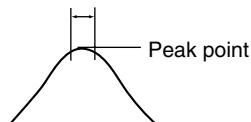

Selection	1pixel*, 5pixel, 9pixel, 13pixel, 17pixel, 21pixel, 25pixel, 29pixel,
------------------	---

The asterisk (*) indicates the default setting.

Step 6 Output Settings

The Z500 can transmit data to an external device in three formats; analog, terminal, and RS-232C. In the example provided below, the procedure for setting the output contents to the external device is explained. The output data and their transmission methods are as follows:

Data	Description	Analog p.100	Terminals p.103	RS-232C p.105
Measurement value	The measurement results for each output number are output in numerical values.	supported	Not supported	supported
Judgment result	The judgment results for each output number are output.	Not supported	supported	supported
Profile	Data on height of 126 lines are output. When setting to Analog , analog waveforms are output.	supported	Not supported	supported
Trend	Only the Trigger function allows this type of output. Data that have been held for each output number are output.	Not supported	Not supported	supported

Analog

Measured values or profile data are converted to analog values and are output. Setting items vary depending on the outputting data.

Outputting Measurement Values

Use the procedure explained below to set the measurement values corresponding to the upper limit (20 mA/5 V) and lower limit (4 mA/-5 V) for analog output. This setting enables output to be scaled (e.g., 1 mm corresponds to 1 mA) as required. Set both the analog output and measurement values so that the upper limit is greater than the lower limit.

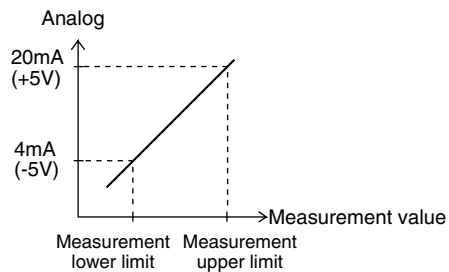

Item	Selection/Setting	Description
Output	OUT0 to OUT7 Profile (OUT0*)	Selects the output number to be set.
4mA (-5V)	-9999.99999 to 9999.99999mm	Sets the lower limit for the analog output measurement range. The default setting varies depending on the Sensor model connected.
20mA (+5V)	-9999.99999 to 9999.99999mm	Sets the upper limit for the analog output measurement range. The default setting varies depending on the Sensor model connected.

The asterisk (*) indicates the default setting.

Outputting Profile Data

Analog waveforms of the data on height of 126 lines are output.

Item	Selection	Description
Output	OUT0 to OUT7 Profile (OUT0*)	Select Profile .
Profile (See note.)	Select the output range of profile data.	
	F.S.*	The output covers the whole measurement range.
	1/2F.S.	The output covers one-half of the measurement range.
	1/4F.S.	The output covers one-quarter of the measurement range.

The asterisk (*) indicates the default setting.

Note: The range of profile varies depending on the Sensor connected.

Example: Z500-SW17

Selection	Output range
F.S.	-20mm to +20mm
1/2F.S.	-10mm to +10mm
1/4F.S.	-5mm to +5mm



CHECK

Refer to page 181 for details on output timing.



CHECK

The setting can be performed through the adjustment menu.



REFERENCE

Refer to page 28.

1. Select **Output**.

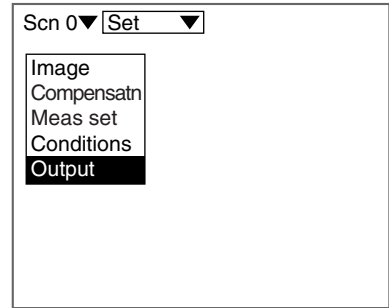

▼

The selections will be displayed.

2. Select **Analog**.



▼

The setting screen for output contents will be displayed.

3. Make the settings for each item.
4. Select **End**.

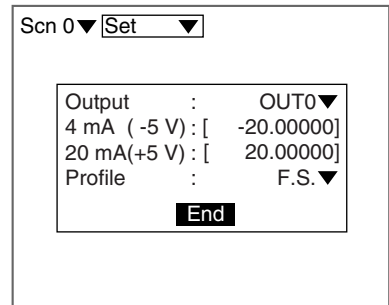

▼

The setting will be registered and the screen in (2.) will return.

Terminal Block Output

Judgment results can be output via the terminal block. The settings are enabled for all output numbers.

Item	Selection/ Setting range	Description
Format	Judge output A*	Select this function to output the details of the judgment (HIGH/PASS/LOW/ERROR). The output includes the judgment results for OUT0 through OUT3. Those for OUT4 through OUT7 will not be output.
	Judge output B	Judgment results for OUT0 through OUT7 will be output in the form of OK or NG. OK : PASS NG : HIGH, LOW, ERROR
OFF delay	0 to 99999 (0*)	Set the OFF delay time N (sampling time × N). Set a time that allows the external device to input the result.
GATE ON delay (See note.)	1.0 to 1000.0ms (1.0ms*)	Set the time from when the result is output to the terminals to when the GATE signal is turned ON. The time to wait until stable output data can be obtained. Set this time longer than the data transmission delay time to external devices.
GATE ON time (See note.)	1.0 to 1000.0ms (5.0ms*)	Set the length of time that the GATE signal remains ON. Set a value so that the external device can obtain the measurement result.

The asterisk (*) indicates the default setting.

Note: The GATE signal is output only when the **Trigger** is set to **External** or **Free**.
If the **Trigger** is not set, the GATE signal will always stay OFF regardless of the settings of the GATE ON delay and GATE ON time.



CHECK

For details on I/O Format, refer to page 154.



CHECK

The setting can be performed through the adjustment menu.



REFERENCE

Refer to page 28.

1. Select **Output**.

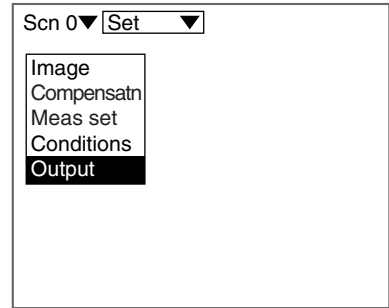

▼
The selections will be displayed.

2. Select **Terminals**.

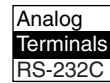

▼
The setting screen for output contents will be displayed.

3. Make the settings for each item.
4. Select **End**.

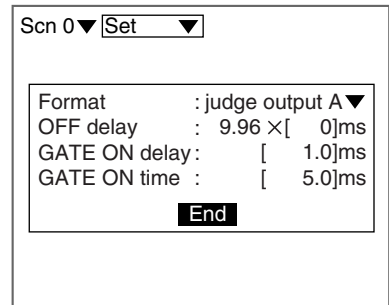

▼
The setting will be registered and the screen in (2.) will return.

RS-232C Output

Measurement values, measurement results, and profile data can be output via the RS-232C. Setting items vary depending on the outputting data.

The same communications settings must be used on both the Z500 and the external device.

 **REFERENCE**

Refer to page 145.

Item	Selection/ Setting range	Description
Format	Command*	Data is output in response to an external command.
	Trigger OFF	Set when the Trigger function is used. Data is output to RS-232C with the trigger-OFF timing.
Data	Measurement*	Measurement values are output to RS-232C. The output method is the same as the MEASURE(M) command.
	Result	Judgment results (HIGH/PASS/LOW/ERROR) are output to RS-232C. The output method is the same as the JUDGE(J) command.
	Measmt+Result	Judgment results and measured values are output to RS-232C. Judgment results and measured values will be output.
	Profile	Profile data is output to RS-232C. The output method is the same as the PROFILE(P) command.
Output #	OUT0 to OUT7 Consecutive (OUT0*)	This item becomes effective when Measurement , Result , and Measmt + Result are selected for Data . Select the output number for which the data is to be output. When Consecutive is selected, data on OUT0 through OUT7 will be continuously output in series.
Sensor #	Sensor 0 Sensor 1	This item becomes effective when Profile is selected for Data . Select the sensor number to be output.

The asterisk (*) indicates the default setting.



For details on I/O Format, refer to page 159.



The setting can be performed through the adjustment menu.

 **REFERENCE**

Refer to page 28.

1. Select **Output**.

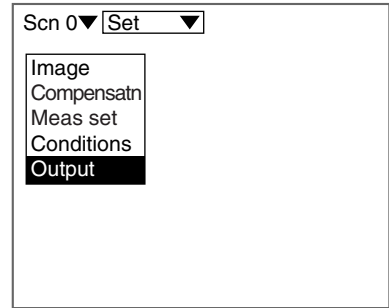

The selections will be displayed.

2. Select **RS-232C**.



The setting screen for output contents will be displayed.

3. Make the settings for each item.
4. Select **End**.

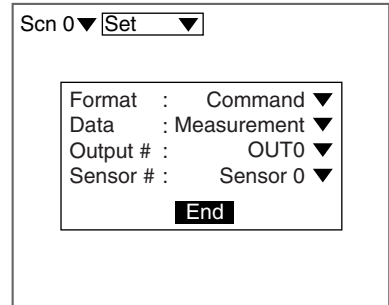

The setting will be registered and the screen in (2.) will return.

Step 7 Performing Measurement

Perform the measurement under the conditions that have been previously set. Use the following procedure to execute measurement according to the conditions set for the scene currently displayed. The data will be output to external devices as well.

1. Confirm that **Run** ▼ is selected.

If **Run** ▼ is not selected, press the **ESC** Key several times to switch the selection.

Measurement will be executed and the measurement results will be displayed on the screen.

Check that measurement has been performed correctly.

The output number for the currently displayed measurement result is displayed.

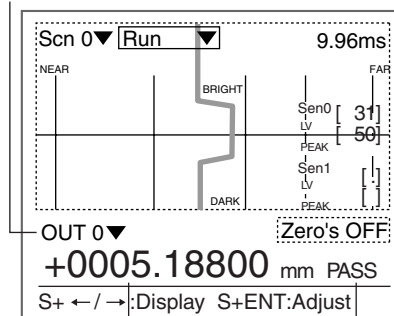

Measurement value

Judgement result



CHECK

Conditions can be changed simply without leaving Run Mode using the adjustment menu. Measurement will be interrupted while adjustments are made.



REFERENCE

Refer to page 28.



CHECK

Change the Monitors using the **SHIFT + Right** Keys or **SHIFT + Left** Keys if necessary.



REFERENCE

Refer to page 29.



CHECK

For measurements through the execution of Force-zero



REFERENCE

Refer to page 110.

4-2 Saving Settings and Exiting the Z500

When settings have been completed, be sure to save to flash memory before turning the power OFF. Refer to SECTION 2 (page 37) for details on saving settings.

 **REFERENCE**

Refer to page 37.

 **NOTICE**

Flash memory data is loaded each time the Z500 is started up. Therefore, when setting have been changed, be sure to save to flash memory before turning the power OFF. If the power is turned OFF without saving, all of the setting changes will be lost.

SECTION 5

Other Functions

SECTION 5 describes additional functions such as changing scenes or backing up data.

5-1 Executing Force-zero	110
5-2 Entering View Mode	112
5-3 Changing the Screen Display	113
5-4 Changing Scenes	125
5-5 Entering Tools Mode	128
5-6 Testing Measurement Performance (<i>Test</i>)	129
5-7 Checking the Line Beam Position (<i>Surrounding image</i>)	135
5-8 Backing Up Data to a Computer (<i>Backup</i>)	136

5-1 Executing Force-zero

Use the Force-zero function to perform measurement for \pm tolerance with respect to a reference value. Force-zero can be executed from the Image Monitor or the Digital Monitor. This section describes the operation procedures, using execution of force-zero through the Image Monitor as an example.

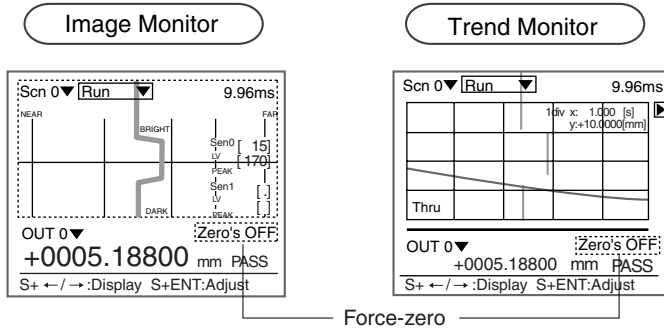

Example: Measure the tolerance on the basis of workpiece height as the reference value.

To judge ± 2 mm is an OK product.

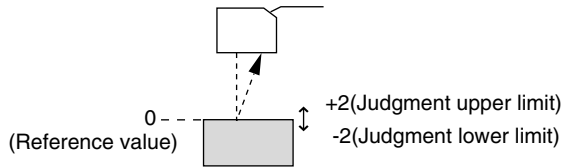

Offset values can also be set as reference values.



Refer to page 84.

Measurement with an Offset Value of 10 with the above Example

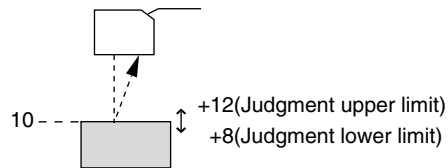

Measurement continues during the Force-zero execution.

1. Move the cursor to **Zero's OFF** and press the **ENT** Key.

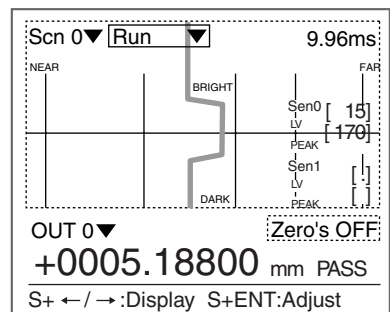

A confirmation message will be displayed.

Yes: Force-zero is executed for the output number displayed.

All 0: Force-zero is executed for all outputs.

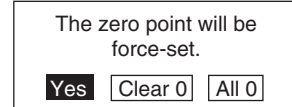

- 2.** Select **Yes** or **All 0**.

Only when selecting **All 0**, go to (3.).

A confirmation message will be displayed.

- 3.** Select **Yes**.

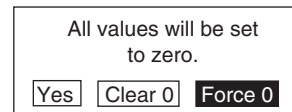

Force-zero is executed, and the screen in (1.) will return.
The screen display changes from **Zero's OFF** to **Zero's ON**.

Clears Force-zero

- 1.** Move the cursor to **Zero's ON** and press the **ENT** Key.

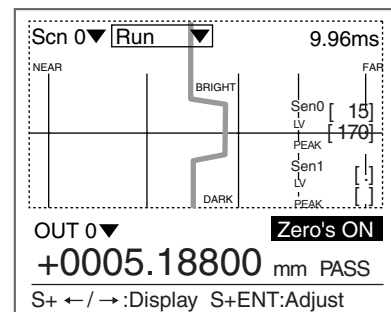

A confirmation message will be displayed.

- 2.** Select **Clear 0**.

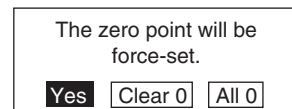

Force-zero is cleared, and the screen in (1.) will return.
The screen display changes from **Zero's ON** to **Zero's OFF**.

5-2 Entering View Mode

Change the contents displayed on the screen in View Mode.

Enter View Mode through the adjustment menu. To enter the View Mode, display the screen of the content to be changed.

In the example provided below, the procedure for entering View Mode through the Image Monitor is explained.

1. Display the Image Monitor and press the **SHIFT + ENT** Keys.

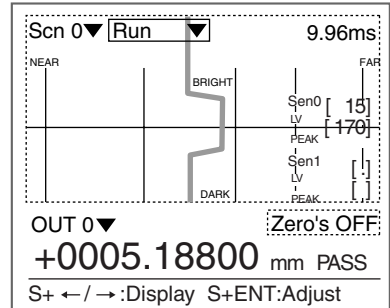

The adjustment menu will be displayed.

2. Press the **TRIG** Key.

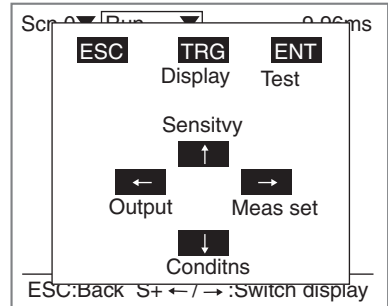

A screen in View Mode will be displayed.



CHECK

The selections displayed vary depending on the type of screen when entering View Mode.

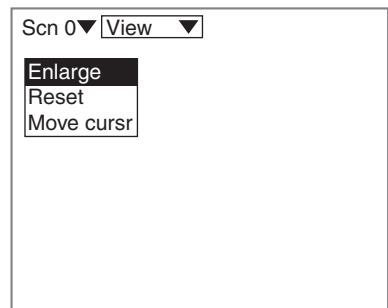

5-3 Changing the Screen Display

Change the contents displayed on the screen. The contents that can be changed vary depending on the type of screen.

Type of screen	Reference
Image Monitor	Page 113.
Digital Monitor	Page 117.
Trend Monitor	Page 118.
Profile Monitor	Page 121.

5-3-1 Changing the Image Monitor's Display Contents

This function can be used for displaying enlarged profile and line brightness. Position of the line brightness cursor can also be changed.



REFERENCE

Refer to page 29 for details on the contents of display on the screen.

Enlarging Display

Profile and line brightness are enlarged.
Specify the enlarged range.

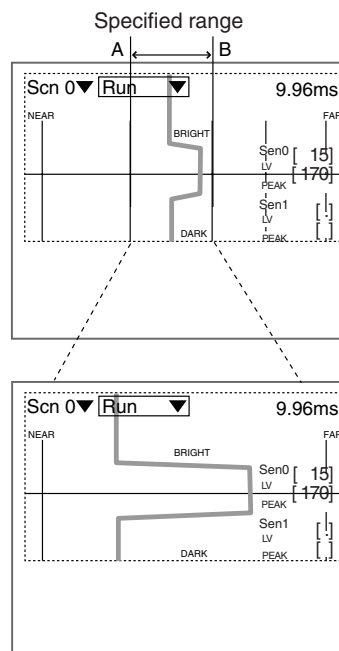

The line brightness graph for the specified range is enlarged in Run Mode.
Press the **TRIG** Key to change the display to Profile.

1. Display the Image Monitor and enter View Mode.



Refer to page 112.

The selections will be displayed.

2. Select **Enlarge**.

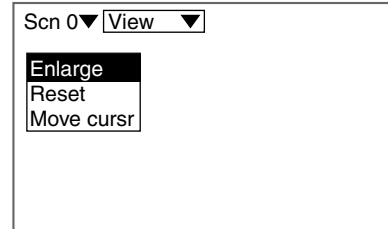

The screen for setting the enlargement range will be displayed.

3. Specify edge A of the enlarged region.

Use the **Left** and **Right** Keys to move the cursor.

Use these keys together with the **SHIFT** Key to move the cursor quickly.

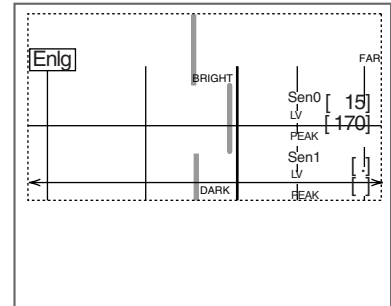

The position of A is registered.

4. Specify edge B by repeating the procedure described in (3.).

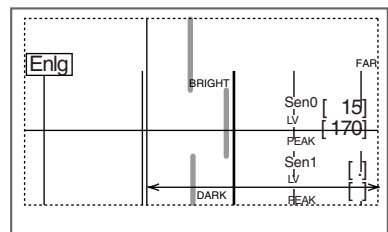

A confirmation message will be displayed.

5. Select **Execute**.

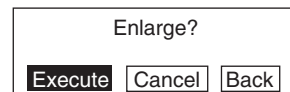

The setting will be registered and the screen in (2.) will return.
Press the **ESC** Key to display the Image Monitor.

Reset

Return the enlarged display to its default setting.

1. Display the Image Monitor and enter View Mode.



Refer to page 112.

The selections will be displayed.

2. Select **Reset**.

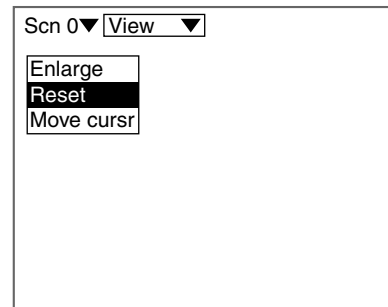

A confirmation message will be displayed.

3. Select **Execute**.

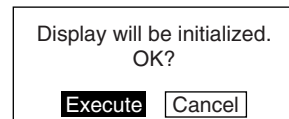

The setting will be registered and the screen in (2.) will return.
Press the **ESC** Key to display the Image Monitor.

Moving cursor

Change the cursor position that displays the line brightness graph.

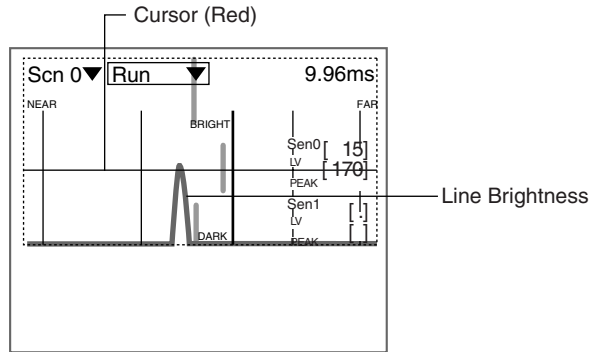

1. Display the Image Monitor and enter View Mode.



Refer to page 112.

The selections will be displayed.

2. Select **Move cursr**.

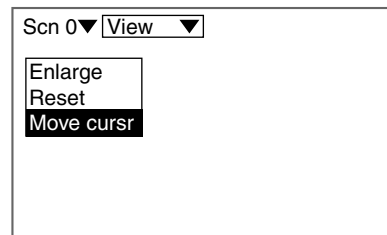

The screen for changing the cursor position will be displayed.

3. Change the cursor position.
Use the **Up** and **Down** Keys to move the cursor.
Use these keys together with the **SHIFT** Key to move the cursor quickly.

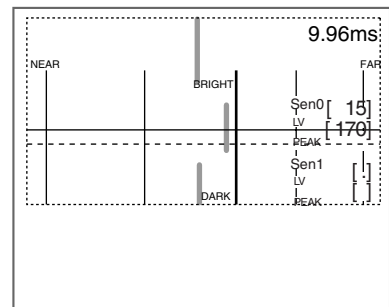

4. Press the **ENT** Key.

The setting will be registered and the screen in (2.) will return.
Press the **ESC** Key to display the Image Monitor.

5-3-2 Changing the Digital Monitor's Display Contents

In addition to measurement values and judgment values, judgment upper and lower limits and measurement items can also be displayed.

The default setting is to display the upper and lower limits. To display measurement items, change the settings.

Judgement (default setting)

Scn 0	Run	9.96ms
0	+0002.65432mm PASS	HI=+0005.00000 LO=-0000.00000
1	+0004.65432mm PASS	HI=+0010.00000 LO=-0005.00000
2	+0000.00000mm ERROR	HI=+0010.00000 LO=-0005.00000
3	-----mm	HI=+0010.00000 LO=-0010.00000
S+ ← / → :Display S+ENT:Adjust		

Judgment upper and lower limits

Measurement

Scn 0	Run	9.96ms
0	+0002.65432mm PASS	Height
1	+0004.65432mm PASS	Step: 2 pts
2	+0000.00000mm ERROR	Width
3	-----mm	
S+ ← / → :Display S+ENT:Adjust		

Measurement items

 **REFERENCE**

Refer to page 29 for details on the contents of display on the screen.

1. Display the Digital Monitor and enter View Mode.

 **REFERENCE**

Refer to page 112.

The items will be displayed.

2. Press the **ENT** Key.

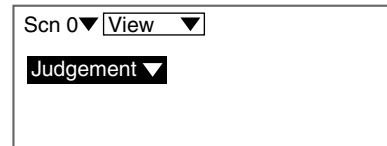

The selections will be displayed.

3. Select an item.

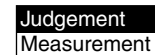

The screen in (2.) will return.

4. Press the **ESC** Key.

The setting will be registered and the screen in the Digital Monitor will return.

5-3-3 Changing the Trend Monitor's Display Contents

Change the screen mode, the waveform display range, and the waveform display time.

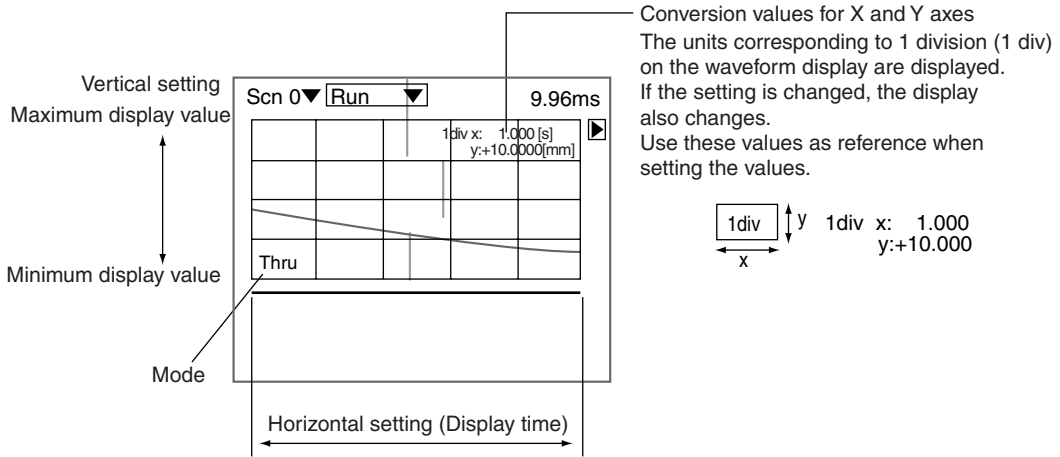

REFERENCE

Refer to page 29 for details on the contents of display on the screen.

Item	Selection/Setting	Description
Mode (See note.)	Thru*	Displays the waveform obtained by the Sensor continuously.
	Trig	Displays a still waveform corresponding to the trigger timing. (Updated when the trigger turns ON.)
Vert	-9999.99999 to 9999.99999	Sets the maximum and minimum values displayed on the screen. Different values can be set for each output number. The default setting varies depending on the Sensor model connected.
Horiz (See note.)	1.00 to 30.00s (5.00s*)	Sets the display time (X axis) for the waveform displayed on the screen.

The asterisk (*) indicates the default setting.

Note: The contents to be set are also used for the Profile Monitor. The contents that have been finally set will become effective.

Changing Modes

The procedure for changing the setting from *Thru* to *Trig* is explained below.

1. Display the Trend Monitor and enter View Mode.

 REFERENCE

Refer to page 112.

The selections will be displayed.

2. Move the cursor to *Thru* and press the ENT Key.

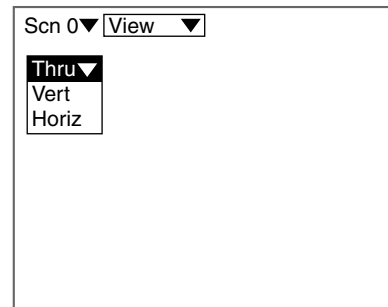

The selections will be displayed.

3. Select *Trig*.



The setting will be registered and the screen in (2.) will return.
Press the **ESC** Key to display the Trend Monitor.

Changing Vertical and Horizontal Settings

1. Display the Trend Monitor and enter View Mode.



Refer to page 112.

The selections will be displayed.

2. Select **Vert** or **Horiz**.

Scn 0 View

Thru
Vert
Horiz

A setting screen will be displayed.

3. Make the settings for each item.

When selecting **Vert**:

Maximum : [20.00000]
Minimum : [-20.00000]
End

4. Select **End**.

When selecting **Horiz**:

Time : [5.00]s
End

The setting will be registered and the screen in (2.) will return.
Press the **ESC** Key to display the Trend Monitor.

5-3-4 Changing the Profile Monitor's Display Contents

Change the screen mode, the waveform display range, the waveform display time, and cursor positions on profile and trend display.

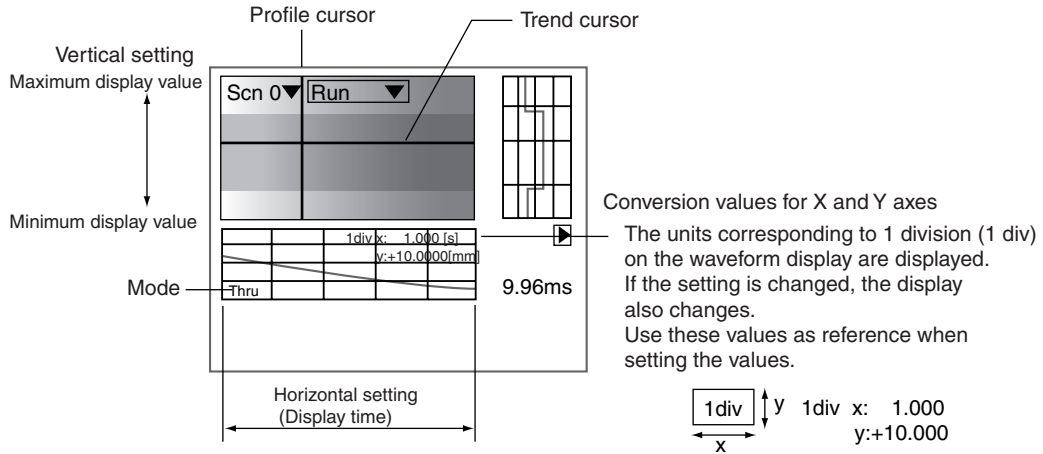

REFERENCE

Refer to page 29 for details on the contents of display on the screen.

Item	Selection/Setting	Description
Mode (See note.)	Thru*	The shaded 3-D image acquired through the Sensor will be displayed continually.
	Trig	A shaded 3-D image will be displayed in response to the trigger timing. (Updated when the trigger turns ON.)
Vert	-9999.99999 to 9999.99999	Sets the maximum and minimum values displayed on the screen. The default setting varies depending on the Sensor model connected.
Horiz (See note.)	1.00 to 30.00s (5.00s*)	Sets the display time (X axis) for the waveform displayed on the screen.
Move cursr	—	Sets the profile and trend display positions.

The asterisk (*) indicates the default setting.

Note: The contents to be set are also used for the Trend Monitor. The contents that have been finally set will become effective.

Changing Modes

The procedure for changing the setting from *Thru* to *Trig* is explained below.

1. Display the Profile Monitor and enter View Mode.



Refer to page 112.

The selections will be displayed.

2. Move the cursor to *Thru* and press the ENT Key.

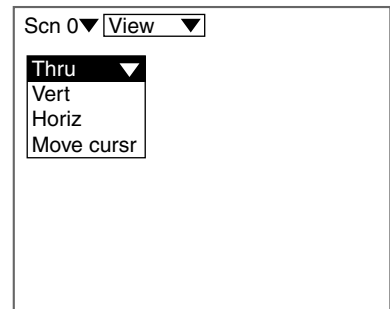

The selections will be displayed.

3. Select *Trig*.



The setting will be registered and the screen in (2.) will return.
Press the ESC Key to display the Profile Monitor.

Changing Vertical and Horizontal Settings

1. Display the Profile Monitor and enter View Mode.

 REFERENCE

Refer to page 112.

The selections will be displayed.

2. Select **Vert** or **Horiz**.

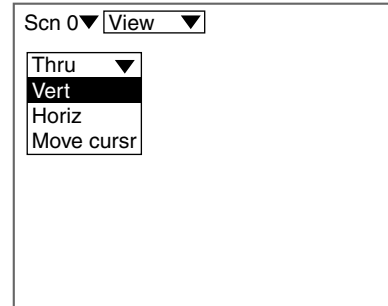

A setting screen will be displayed.

3. Make the settings for each item.

When selecting **Vert**:

Maximum :	[20.00000]
Minimum :	[-20.00000]
End	

4. Select **End**.

When selecting **Horiz**:

Time :	[5.00]s
End	

The setting will be registered and the screen in (2.) will return.
Press the **ESC** Key to display the Trend Monitor.

Moving cursor

1. Display the Profile Monitor and enter View Mode.



Refer to page 112.

The selections will be displayed.

2. Select **Move cursr** and press the **ENT** Key.

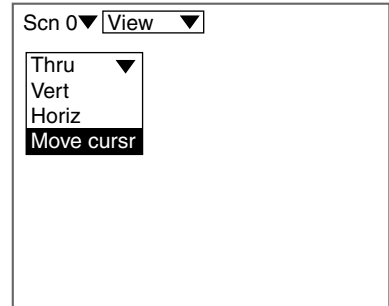

The screen for changing the cursor position will be displayed.

3. Change the cursor position.
Use the **Up**, **Down**, **Left**, and **Right** Keys to move the cursor.
Use these keys together with the **SHIFT** Key to move the cursor quickly.
4. Press the **ENT** Key.

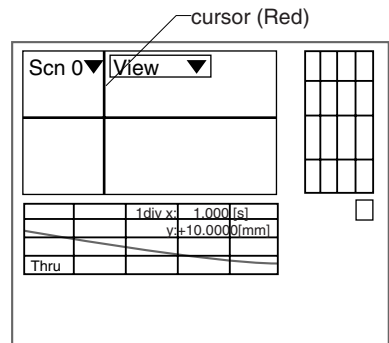

The setting will be registered and the screen in (2.) will return.
Press the **ESC** Key to display the Profile Monitor.

5-4 Changing Scenes

The different situations (types of measurement workpiece and types of measurements required) in which measurements are performed are called "scenes" and the measurement conditions set under Set Mode are called "scene data." The Scene function can be used to set 16 types of measurement conditions.

If measurement conditions change, simply switch to change to a different measurement setup.

The methods used to switch, copy, and clear scenes are explained below.

5-4-1 Setting Measurement Conditions for Different Models (Changing Scenes)

Use the scene changing function to switch between different measurement conditions for different measurement setups or measurement workpieces. Scene 0 will be displayed by default when the power is turned ON, however, the Z500 also accommodates scenes 1 to 15.

The method for switching the scene on the Console is explained below.

The command for switching scenes can also be input from the terminal block or via RS-232C.

 **REFERENCE**

For details on input from the terminal block, refer to page 154.

 **REFERENCE**

For details on input from RS-232C, refer to page 160.

1. Move the cursor to **Scn** and press the **ENT** Key.

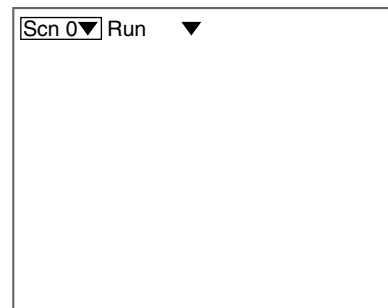

The Scene 0 to Scene 8 options will be displayed.

Use the **Down** Key to display the scene numbers 9 to 15.

2. Move the cursor to the scene number to be switched to and press the **ENT** Key.

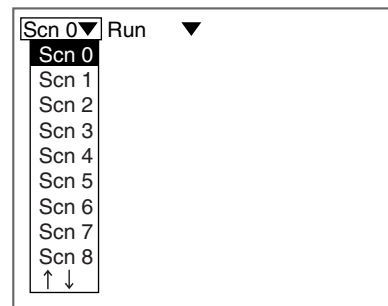

The selected scene will be displayed.

5-4-2 Copying Measurement Conditions to Other Scenes (Copying Scene Data)

This function is useful for creating new scenes by copying scene data from another scene and changing some settings to suit the new requirements.

1. Move the cursor to **Scn** and press the **ENT** Key.



The Scene 0 to Scene 8 options will be displayed.
Use the **Down** Key to display the scene numbers 9 to 15.

2. Move the cursor to the scene number to be copied and press the **SHIFT+ESC** Keys.

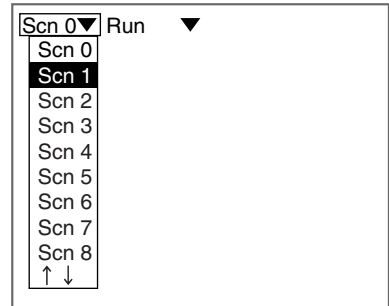

The selections will be displayed.



3. Select **Copy**.

The screen for copying will be displayed.

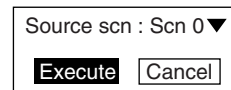

4. Enter the number of the scene to be copied (**Source scn**), and select **Execute**.

The data will be copied.

5-4-3 Initializing Scene Measurement Conditions (Clearing Scenes)

Use the following procedure to clear measurement conditions set in Set Mode, and to return scenes to their default settings.

This section explains the procedure performed separately for each scene.

1. Move the cursor to **Scn** and press the **ENT** Key.

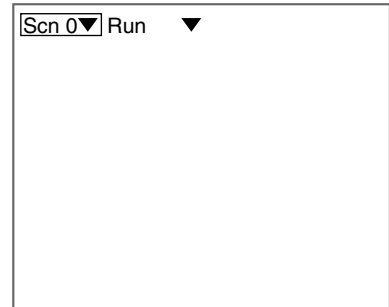

The Scene 0 to Scene 8 options will be displayed.

Use the **Down** Key to display the scene numbers 9 to 15.

2. Move the cursor to the number of the scene to be cleared. Press the **SHIFT+ESC** Keys.

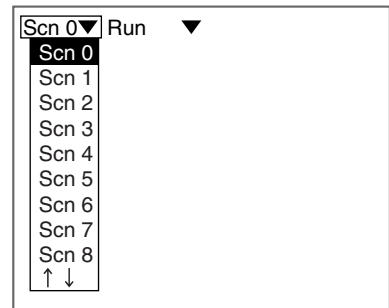

The selections will be displayed.



3. Select **Clear**.

A confirmation message will be displayed.

4. Select **Execute**.

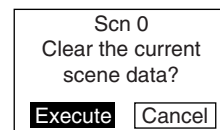

The scene will be cleared.

5-5 Entering Tools Mode

Enter Tools Mode to use the useful functions.

1. Move the cursor to **Run** and press the **ENT** Key.

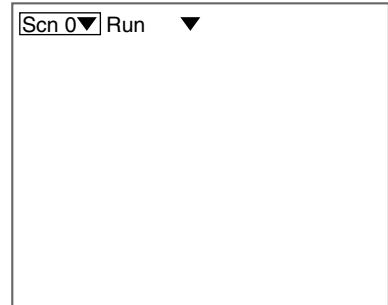

A list of modes will be displayed.

2. Select **Tools**.

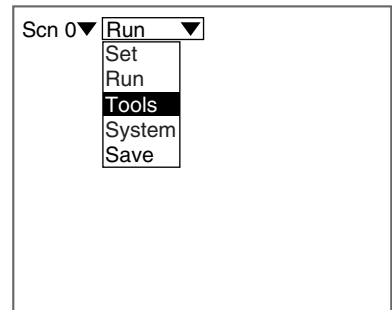

The Tools Mode selections will be displayed.

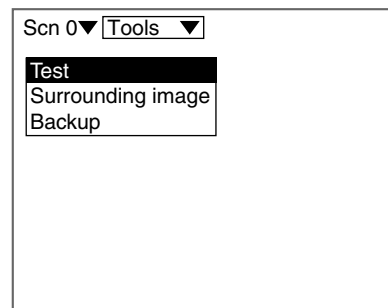

5-6 Testing Measurement Performance (*Test*)

Use the following procedure to execute measurements according to the conditions set for the output number currently displayed. The test is completed internally by the Z500 and the measurement results are not output via terminal or RS-232C.

Two methods have been provided for the test. Select an appropriate method.

Test Mode

Selection	Description
# times*	Test measurement is performed for the sampling number of times set.
Trg key	Use the TRIG Key to specify the starting and stopping test measurement. Test measurement can be performed in stopwatch-style.

Number of Samples

Selection	Description
1 to 9999 (100*)	Effective when setting Test mode to # times . Enter the number of times for test measurement.



CHECK

The Trigger function will become ineffective during the test measurement.

Output number

The output number being tested is displayed.

Press the **Up** and **Down** Keys to change the number.

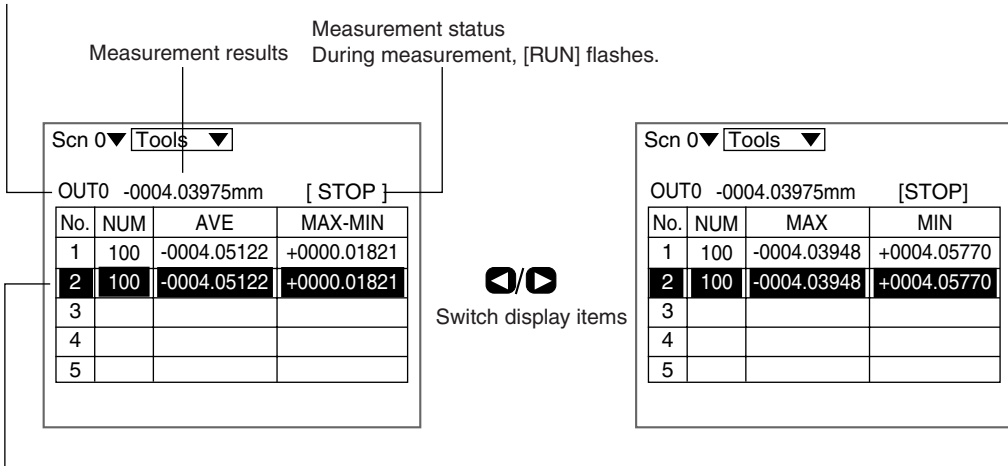

Test results

The most recent test results are displayed in reverse video.

After the 5th measurement, the previous results are overwritten in order starting from 1.

Item	Description
NUM	Displays the number of measurements performed during the test measurement period.
AVE	Displays the average measurement value for the test measurement period.
MAX-MIN	Displays the maximum and minimum measurement values for the test measurement period.
MAX	Displays the maximum measurement value for the test measurement period.
MIN	Displays the minimum measurement value for the test measurement period.



Up to 5 sets of measurement results can be displayed in list format. This feature is useful for the following.

- Comparing measurements for different items
- Comparing the still state and moving state
- Evaluating repeat accuracy

When selecting # times

1. Enter Tools Mode.



Refer to page 128.

The selections will be displayed.

2. Select **Test**.

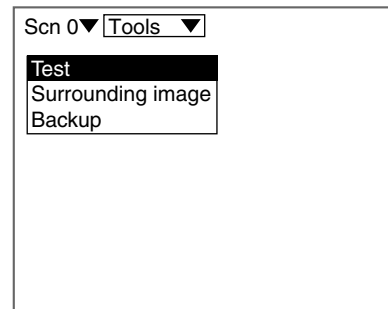

The test measurement screen will be displayed.

3. Position the workpiece to be tested and press the **ENT** Key.

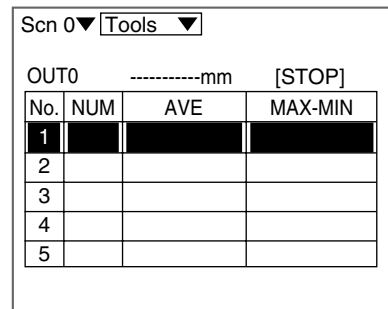

A menu for selecting test methods will be displayed.

4. Set **Test mode** to # times.
5. Make the required setting for # of samples and select **End**.

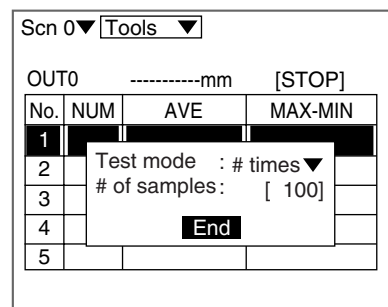

The screen in (3.) will return.

- 6.** Press the **TRIG** Key.

Test measurement is performed for the number of times set and the measurement results are displayed.

Use the **Left** and **Right** Keys to switch display items.

- 7.** To continue testing, repeat (6.).
- 8.** To stop testing, press the **ESC** Key.

When measurement starts, the display changes from [STOP] to [RUN].
During measurement, [RUN] flashes.

Scn 0 ▾ Tools ▾

OUT0 -0001.81313mm [RUN]

No.	NUM	AVE	MAX-MIN
1	100	-0001.82836	+0000.00367
2	100	-0001.82600	+0000.00305
3			
4			
5			

A Tools Mode screen will return.

When selecting *Trg* key

1. Perform the same operations as those described in (1.) to (3.) in the procedure for when selecting # *times*.



Refer to page 131.

A menu for selecting test methods will be displayed.

2. Set the *Test mode* to *Trg* key.
3. Select *End*.

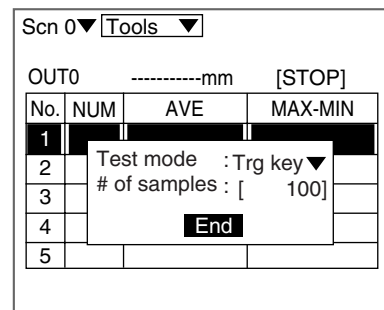

The screen in (3.) will return.

4. Press the **TRIG** Key.

Testing starts and the display changes to [RUN].

5. Press the **TRIG** Key again.

When measurement starts, the display changes from [STOP] to [RUN]. During measurement, [RUN] flashes.

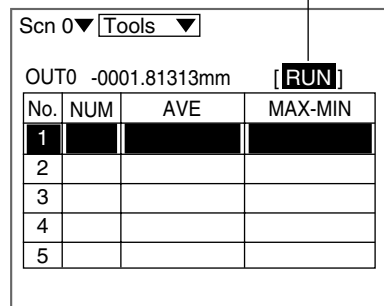

Testing is stopped and the measurement results are displayed.

Use the **Left** and **Right** Keys to switch display items.

6. To continue testing, repeat (4.) and (5.).



CHECK

Use the **Up** and **Down** Keys to switch output numbers.

7. To stop testing, press the **ESC** Key.

Scn 0		Tools	
OUT0		-0001.81313mm	[STOP]
No.	NUM	AVE	MAX-MIN
1	---	-0001.82836	+0000.00367
2			
3			
4			
5			

A Tools Mode screen will return.

5-7 Checking the Line Beam Position (*Surrounding image*)

Displays images of the area surrounding the part that the line beam strikes. Whether or not the line beam strikes the part required for measurement can be checked on the screen. This function is useful when the Sensor is mounted inside an installation and the measurement area cannot be checked directly.



CHECK

If the Z500-SW2 Sensor is connected, move the beam cover lever to the left.



REFERENCE

Refer to page 20, *Setup Manual*.

1. Enter Tools Mode.



REFERENCE

Refer to page 128.

The selections will be displayed.

2. Select **Surrounding image**.



Two Sensor

The sensor selections will be displayed. Select the number of the sensor used for displaying the image.

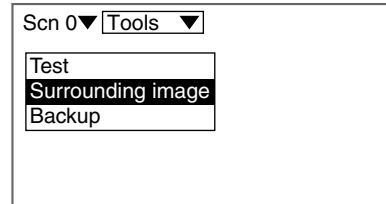

The screen for recording images will be displayed.

3. Press the **TRIG** Key.

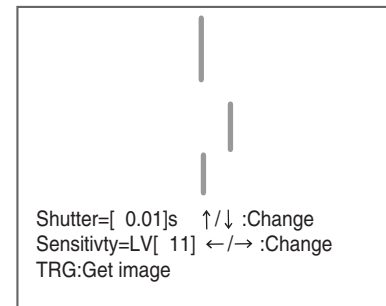

An image of the area surrounding the line beam is displayed.

Z500-SW17: Displays the image for the shutter time displayed.

Z500-SW2: The Z500 will search for the most suitable shutter time and will display the image.



CHECK

If the image is difficult to see clearly, adjust the image.

Change the shutter speed using the **Up** and **Down** Keys.

Use these keys together with the **SHIFT** Key to move the cursor quickly.

Adjust the sensitivity level using the **Left** and **Right** Keys.

Image Brighter ↔ Darker

Shutter time 10s ↔ 0.05s

Sensitivity level 31 ↔ 0

Press the **ENT** Key to switch the lighting. (ON/OFF) (If the Z500-SW2 Sensor is connected.)

4. To stop displaying, press the **ESC** Key.

A Tools Mode screen will return.

5-8 Backing Up Data to a Computer (*Backup*)

Settings for the 4 categories shown below can be saved to or loaded from a computer. This is a useful function for making the same settings on another device. Also, as a countermeasure against data corruption and equipment failure, it is recommended that settings are backed up to a computer.

Selection	Description
Scene	Saves or loads the settings under Set in scene units.
System	Saves or loads the settings (except the settings of Slant correct) under System in scene units.
Sys + scn	Saves or loads both system and scene data (0 to 15) together.
Slant data	Saves or loads the settings of System/Slant correct . The following four types of data will be saved or loaded in block. - For Sensor 0 (Wide) - For Sensor 0 (Zoom) - For Sensor 1 (Wide) - For Sensor 1 (Zoom)

Example of Operation at the Computer

This section describes data transfer procedures, using Hyper Terminal, a standard tool for Windows 95/98 and Windows NT4.0/2000. This example is based on the presumption that an RS-232C cable has been connected to the COM1 port on the personal computer. Make the necessary adjustments when the cable is connected to a different port. If using different communications software, refer to the relevant manual. Data is transferred using XMODEM (-CRC or -SUM) protocol. XMODEM (-1K) is not supported.



NOTICE

Do not turn OFF the power or input a RESET signal while a message is being displayed in any save or load operation. Data in memory will be destroyed, and the Z500 may not operate correctly the next time it is started.

5-8-1 Saving Scene Data to a Computer

The procedure for saving the scene data for **Scn0** to the personal computer is explained below.

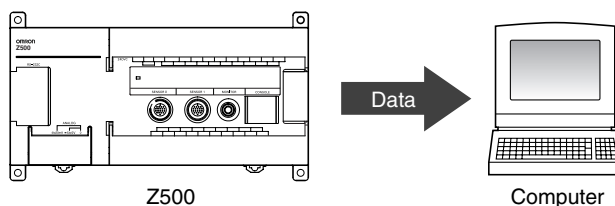

1. Connect the RS-232C cable to the COM1 port on the personal computer and the RS-232C port on the Z500.

- Make the Z500 communications settings.
The default communications settings are as shown in the following table. These settings can normally be used.

 REFERENCE

For details on setting communications specifications, refer to page 145.

Item	Setting
Baud rate	38400 (bps)
Data length	8 (bit)
Parity bit	None
Stop bits	1 (bit)
Delimiter	CR

- Start the Hyper Terminal program on the computer and make the following communications settings.
The same communications settings must be used on both the Z500 and the modem on the computer.

Item	Setting
Speed (B)	38400 (bps)
Data bits (D)	8 (bit)
Parity bit	None
Stop bits	1 (bit)
Flow	None*

Xmodem protocol is used.

- Once the preparations have been completed on the computer, enter Tools Mode.

 REFERENCE

Refer to page 128.

The selections will be displayed.

- Select **Backup**.

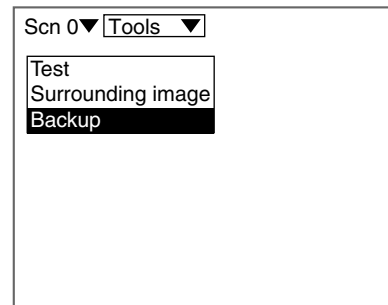

The selections will be displayed.

- Select **Scene**.

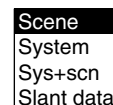

The selections will be displayed.

- 7.** Select **Z500 to PC**.

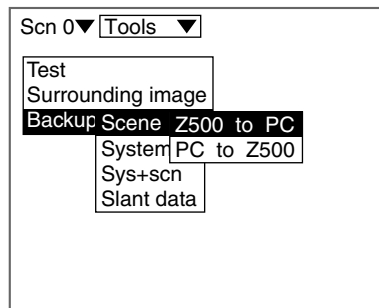

The selections for scene numbers will be displayed.

- 8.** Select the data to be saved on the computer.
Select **Scn0** in this example.

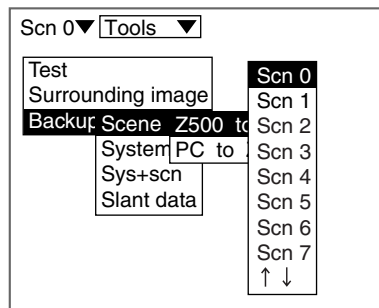

A confirmation message will be displayed.

- 9.** Select **Execute**.

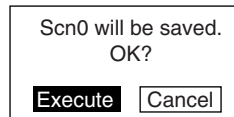

A screen showing the transfer progress will be displayed.

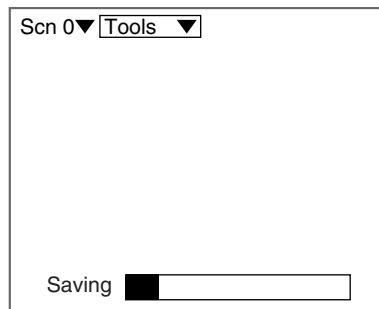

10. Select **Transfer/Receive File** from the Hyper Terminal menu on the computer.
11. Specify where the file is to be saved.
12. Set the protocol to **Xmodem**.
13. Click **Receive** and input the file name.

The data will be transferred from the Z500 to the computer.

When the transfer has been completed, the screen in (8.) will return.



CHECK

During communications, the Z500 will generate a timeout error if there is no response from the external device for more than 110 s. An error message will be displayed on the screen.

5-8-2 Loading Scene Data from a Computer

In the example provided below, the procedure for loading the scene data onto **Scn2** is explained.

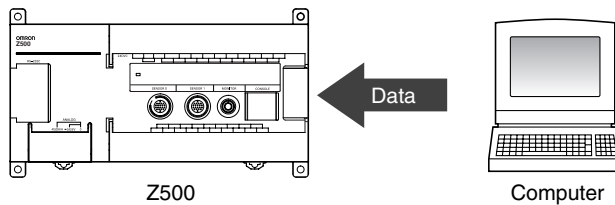

1. Perform the same operations as those described in (1.) to (3.) in the procedure for 5-8-1 Saving Scene Data to a Computer.

 **REFERENCE**

Refer to page 136.

2. Select **Transfer/Send File** from the Hyper Terminal menu on the computer.
3. Select the file to be loaded.
4. Set the protocol to **Xmodem**.
5. Select **Send**.
The data transfer screen will be displayed.

6. Once the preparations have been completed on the computer, enter Tools Mode.

 **REFERENCE**

Refer to page 128.

The selections will be displayed.

7. Select **Backup**.

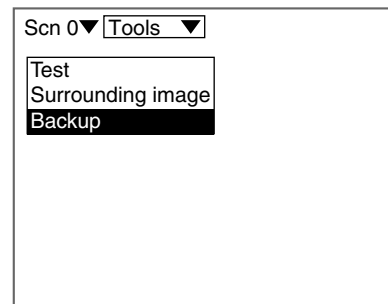

The selections will be displayed.

8. Select **Scene**.
9. Select **PC to Z500**.
10. Select the data to be loaded.
Select **Scn2** in this example.

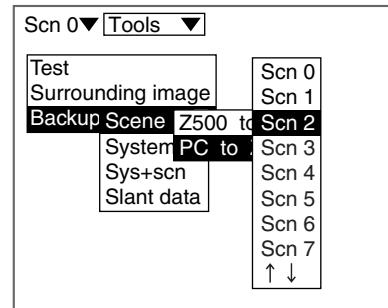

A confirmation message will be displayed.

11. Select **Execute**.

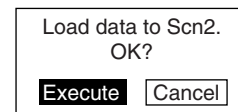

The data will be transferred from the computer to the Z500.

When the transfer has been completed, the screen in (8.) will return.



CHECK

During communications, the Z500 will generate a timeout error if there is no response from the external device for more than 110 s. An error message will be displayed on the screen.

MEMO

SECTION 6

System Settings

SECTION 6 describes how to set conditions related to the system environment.

6-1	Entering System Mode	144
6-2	Setting RS-232C Communications Specifications (<i>Comm</i>)	145
6-3	Environment Settings	146
6-4	Downloading the Sensor Information to the Controller	148
6-5	Compensating Installation Error (<i>Slant correct</i>)	149
6-6	Initializing the Z500 (<i>Initialize</i>)	151
6-7	Checking the System Version (<i>Version</i>)	152

6-1 Entering System Mode

To set conditions related to the system environment, it is necessary to enter System Mode.

1. Move the cursor to **Run** and press the **ENT** Key.

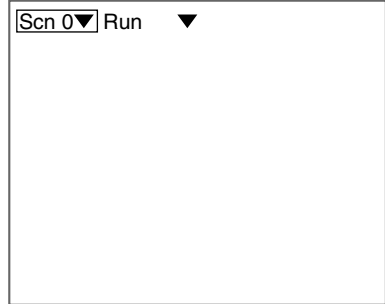

The mode selections will be displayed.

2. Select **System**.

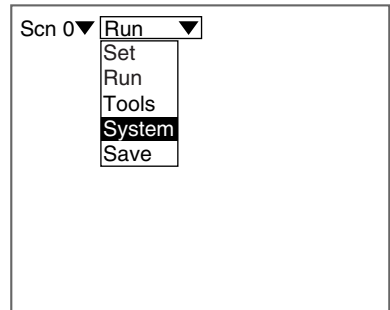

The System Mode selections will be displayed.

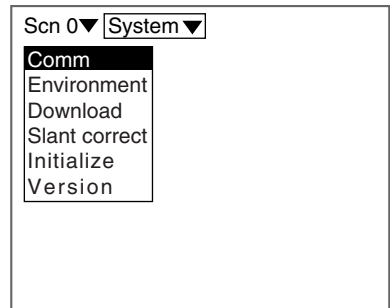

6-2 Setting RS-232C Communications Specifications (*Comm*)

This section describes the communications settings used for the RS-232C port.

The same communications settings must be used on both the Z500 and the external device.



For details on I/O Format, refer to page 159.

Item	Selection	Description
Baud rate	2400, 4800, 9600, 19200, 38400* bps	Set the same settings that are set in the personal computer.
Data length	7, 8* bit	
Parity bit	None*, Even, Odd	
Stop bits	1*, 2 bit	
Delimiter	CR*, LF, CR+LF	
Flow	None*	Flow control is not performed.
	RS/CS	Flow control performed by the hardware. Use a cable that connects the Z500 and the RS signals and CS signals from the external device. Data is sent when the CS signal from the external device is ON.
	Xon/Xoff	Flow control performed by the software. Data is sent in accordance with the Xon/Xoff code sent from the external device.

The asterisk (*) indicates the default setting.

1. Enter System Mode and select **Comm**.



Refer to page 144.

Scn 0 ▼ System ▼
Comm
 Environment
 Download
 Slant correct
 Initialize
 Version

A setting screen will be displayed.

2. Make the settings for each item.
3. Select **End**.

Scn 0 ▼ System ▼

Baud rate : 38400bps ▼
 Data Length : 8bit ▼
 Parity : None ▼
 Stop bits : 1bit ▼
 Delimiter : CR ▼
 Flow : None ▼

End

The setting will be registered and the screen in (1.) will return.

6-3 Environment Settings

Environment settings for the Z500's system can be made using the items shown below.

Item	Selection	Description
Settings	Conversatn* Expert	Select the menu used to set the measurement conditions.
Sensor	Diffuse* Mirror	Select the Sensor mounting method. Select the item that corresponds to the mounting method used for the Sensor connected. The default setting varies depending on the Sensor model connected.
Scene	Console* Terminals	Select whether scene changing is performed on the Console or using the terminal block.
Monitor	Image* Digital Trend Profile	Select the type of screen that is displayed when the power supply is turned ON.
1st scene	Scn 0* to Scn 15	Select the scene number that is displayed when the power supply is turned ON.
Dec. pts	1 to 5* digits	Select the lowest digit of measurement values displayed on the monitor.
Download	ON OFF*	<p>The Z500 acquires information from the sensor at startup. The startup time can be shortened by downloading this information into the controller and storing it.</p> <ul style="list-style-type: none"> •ON The information stored inside the controller is acquired at startup. The startup time will be shortened by comparison to when the OFF function is used. •OFF Information is acquired via the sensor connection at startup. The startup time will be longer than when the ON function is used. <p> NOTICE</p> <p>To replace the sensor for connection to the controller, perform the following procedure:</p> <ol style="list-style-type: none"> 1. Turn OFF the download function. 2. Replace the sensor. 3. Download the new sensor information. 4. Turn ON the download function. <p>If the sensor is replaced when the download function is ON, measurements cannot be taken correctly with the new sensor, because the old sensor information (such as the measurement range) is still stored.</p> <p>Also, perform the above procedure when a sensor of the same model is used to replace the existing sensor.</p>

The asterisk (*) indicates the default setting.

1. Enter System Mode and select **Environment**.



REFERENCE

Refer to page 144.

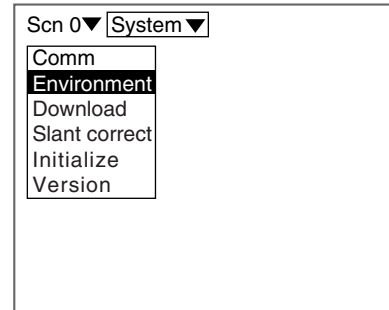

A setting screen will be displayed.

2. Make the settings for each item.
3. Select **End**.

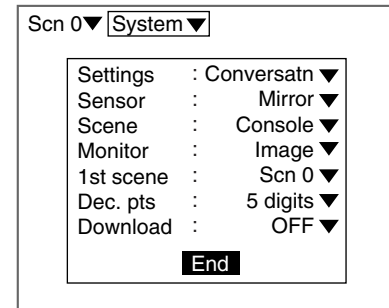

The setting will be registered and the screen in (1.) will return.

6-4 Downloading the Sensor Information to the Controller

When the download function is ON, download the sensor information to the controller in advance.

1. Enter the System mode and select **Download**.



REFERENCE

Refer to page 144.

Scn 0 ▼ System ▼
Comm
Environment
Download
Slant correct
Initialize
Version

A confirmation screen will be displayed.

2. Select **Execute**.

Download the sensor data?
Execute Cancel

Download is executed and the screen in (1.) will return.

6-5 Compensating Installation Error (*Slant correct*)

The profile of a workpiece may sometimes be slanted in the Image Monitor, even when it is measured after being held horizontally. This is mainly caused by erroneous orientation of the sensor.

The installation error compensation function will calculate automatically the value for slant correction of the sensor, and thus permits high accuracy measurement of workpiece profiles.

The value for slant compensation will be calculated specifically for the sensor that has currently been used for the measurement (Sensor 0 or Sensor 1) and the measurement method (Wide or Zoom).

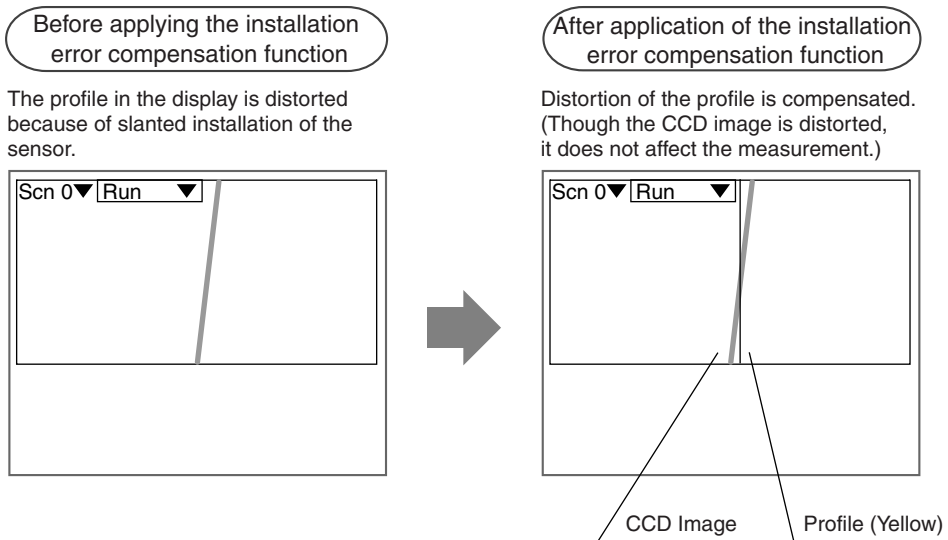

CHECK The value that has been set for *Slant correct* is not included in the system data.

1. Install a horizontal base.
2. Enter System Mode and select *Slant correct*.



REFERENCE

Refer to page 144.

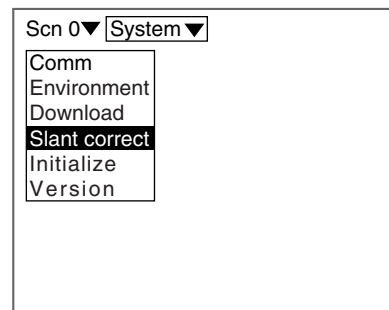

The selections will be displayed.

3. Select *Setting*.

Setting
Clear

A setting screen will be displayed.

4. Press the **ENT** Key.

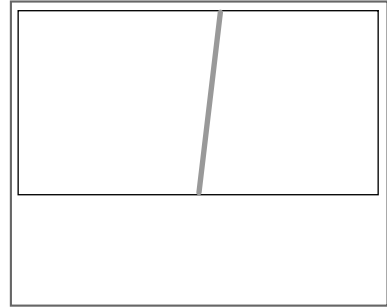

An optimum correction value will be set and the screen in (1.) will return.

Clearing the Value for Installation Error Correction

Only the correction values for the sensor that has currently been used for the measurement (Sensor 0 or Sensor 1) and for the measurement method (Wide or Zoom) will be cleared.

1. Enter System Mode and select **Slant correct.**
2. Select **Clear.**

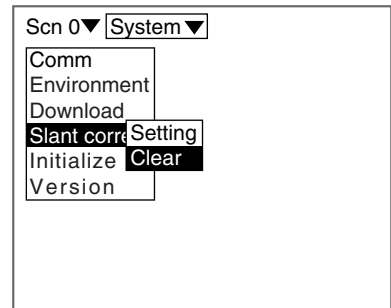

A confirmation message will be displayed.

3. Select **Execute.**

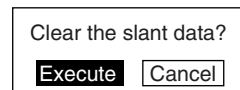

The correction value will be cleared and the screen in (1.) will return.

6-6 Initializing the Z500 (*Initialize*)

Use the procedure shown below to return the Z500 to its default settings.

 **REFERENCE**

For details on how to clear measurement conditions in scene unit, refer to page 127.

 **CHECK**

When the Z500 is initialized, all the settings return to their default values. To save the settings, back them up to a computer before performing initialization.

 **REFERENCE**

For details on how to backup the setting data to a computer, refer to page 136.

1. Enter System Mode and select **Initialize**.

 **REFERENCE**

Refer to page 144.

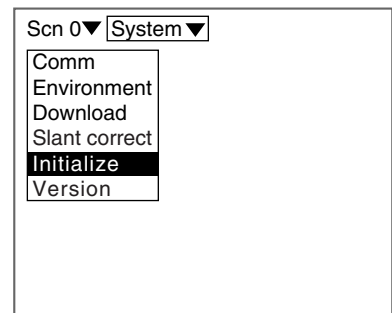

A confirmation message will be displayed.

2. Select **Yes**.

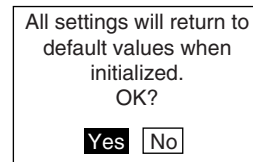

A confirmation message will be displayed.

3. Select **Execute**.

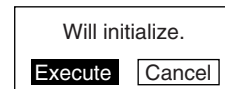

The system will be initialized and another confirmation message will be displayed.

4. Select **OK**.

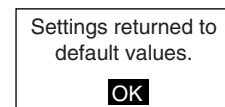

The screen in (1.) will return.

6-7 Checking the System Version (*Version*)

Use the following procedure to display the Controller model number and the software version.

1. Enter System Mode and select **Version**.



Refer to page 144.

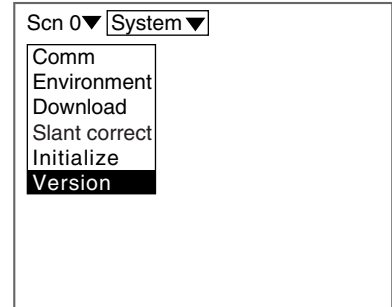

The version information will be displayed.

2. Select **OK**.

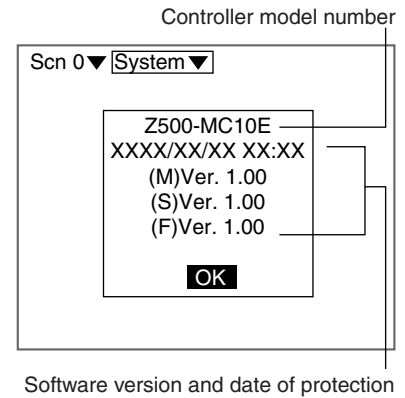

The screen in (1.) will return.

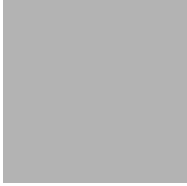

SECTION 7

I/O Format

This section provides details on the inputs and outputs used for communications with external devices via terminal blocks or RS-232C.

7-1 Terminal Blocks	154
7-2 RS-232C	159
7-3 Analog Output	180

7-1 Terminal Blocks

Details on terminal functions and timing for communications with external devices via terminal blocks are provided below.

Input Terminals

The following types of input are available from the terminal blocks in Run Mode.

Input Terminals

Terminal	Function																														
RESET	Measurement values and settings that have not been saved are cleared. The Z500 restarts after the data and settings have been cleared.																														
TRIGGER	Used as a timing trigger for the Trigger function. It is effective when the Trigger input method is set to External .  REFERENCE For details on the Trigger function, refer to page 90.																														
LDOFF	The laser diode is turned OFF.																														
DI0	Force-zero is performed for OUT0. To clear force-zero, turn this terminal ON for at least 1 s.																														
DI1	Force-zero is performed for all output numbers. To clear force-zero, turn this terminal ON for at least 1 s.																														
DI2	Not used																														
DI3	Not used																														
DI4 to DI7	Used in combination to switch scenes. The scene switching time is approximately 2 seconds. <table border="1" data-bbox="720 1062 987 1207"> <thead> <tr> <th></th> <th>D17</th> <th>D16</th> <th>D15</th> <th>D14</th> </tr> </thead> <tbody> <tr> <td>scn0</td> <td>0</td> <td>0</td> <td>0</td> <td>0</td> </tr> <tr> <td>scn1</td> <td>0</td> <td>0</td> <td>0</td> <td>1</td> </tr> <tr> <td></td> <td colspan="4" style="text-align: center;">⋮</td> </tr> <tr> <td>scn14</td> <td>1</td> <td>1</td> <td>1</td> <td>0</td> </tr> <tr> <td>scn15</td> <td>1</td> <td>1</td> <td>1</td> <td>1</td> </tr> </tbody> </table> 0:OFF 1:ON		D17	D16	D15	D14	scn0	0	0	0	0	scn1	0	0	0	1		⋮				scn14	1	1	1	0	scn15	1	1	1	1
	D17	D16	D15	D14																											
scn0	0	0	0	0																											
scn1	0	0	0	1																											
	⋮																														
scn14	1	1	1	0																											
scn15	1	1	1	1																											



CHECK

To enable scenes to be changed from the terminal blocks, change the setting of **Environment/Scene** to **Terminals**.



REFERENCE

Refer to page 146.



CHECK

Time to Turn ON the Input Terminals (with the exception of changing scene)
The ON time depends on the sensitivity adjustment method that has been set.

Auto and **Fixed**: Sampling time × 2 min.

Multi: 9.96 ms × 2 min.

Output Terminals

The contents that can be output to the terminal blocks are shown below. The terminal block allocation depends on the output contents.

REFERENCE

For details on how to set output contents, refer to page 103.

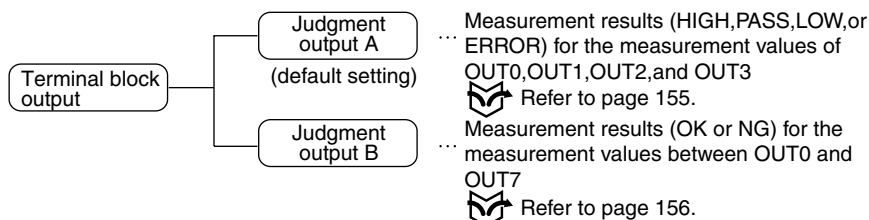

Judgment output A

Judgment results (HIGH, PASS, LOW, or ERROR) for the measurement values of OUT0, OUT1, OUT2, and OUT3 are output to terminals DO0 through DO15.

Result	Meaning
HIGH	Judgment upper limit < Measurement value: Turns ON
PASS	Judgment lower limit \leq Measurement value \leq Judgment upper limit: Turns ON
LOW	Measurement value < Judgment lower limit: Turns ON
ERROR	Turns ON if the Sensor cannot perform measurement. -When the workpiece is outside the measurement range or when the light density is excessive or insufficient. -Information on the measurement point cannot be obtained, even though the point has been set in the measurement item menu. (The image does not appear in the measurement region, the edge position cannot be detected, and other abnormalities.)

Output Contents and Terminal Allocation

	Output contents	Output Terminals
OUT0	HIGH	$\overline{DO0}$
	PASS	$\overline{DO1}$
	LOW	$\overline{DO2}$
	ERROR	$\overline{DO3}$
OUT1	HIGH	$\overline{DO4}$
	PASS	$\overline{DO5}$
	LOW	$\overline{DO6}$
	ERROR	$\overline{DO7}$
OUT2	HIGH	$\overline{DO8}$
	PASS	$\overline{DO9}$
	LOW	$\overline{DO10}$
	ERROR	$\overline{DO11}$

	Output contents	Output Terminals
OUT3	HIGH	$\overline{DO12}$
	PASS	$\overline{DO13}$
	LOW	$\overline{DO14}$
	ERROR	$\overline{DO15}$
	ALL-PASS (See note 1.)	$\overline{DO16}$
	ERROR (See note 2.)	$\overline{DO17}$
	RUN (See note 3.)	$\overline{DO18}$
	BUSY (See note 4.)	$\overline{DO19}$

Note 1: Will be turned ON when all measurement results are judged to be PASS for the already registered output numbers. This can be used for the comprehensive judgment. However, the OFF delay will not function.

Note 2: Will be turned ON if at least one of the measurement results is judged to be ERROR for the already registered output numbers. This can be used to identify that an error has occurred. However, the OFF delay will not function.

Note 3: Will be turned ON during measurement. Will be turned OFF while the scene is changed or set.

Note 4: Will be turned ON during Trigger measurement. Use this terminal to confirm whether or not the trigger is operating normally when self-trigger is set as the trigger input method.

Judgment output B

Judgment results (OK or NG) for the measurement values of OUT0 through OUT7 are output to terminals DO0 through DO7.

Result	Meaning
OK	PASS (Judgment lower limit \leq Measurement value \leq Judgment upper limit): Turns ON
NG	HIGH (Judgment upper limit < Measurement value), LOW (Judgment lower limit > Measurement value), or ERROR (The Sensor cannot perform measurement): Turns ON

Output Contents and Terminal Allocation

Output contents	Output Terminals
OUT0	$\overline{DO0}$
OUT1	$\overline{DO1}$
OUT2	$\overline{DO2}$
OUT3	$\overline{DO3}$
OUT4	$\overline{DO4}$
OUT5	$\overline{DO5}$
OUT6	$\overline{DO6}$
OUT7	$\overline{DO7}$
Not used	$\overline{DO8}$ to $\overline{DO15}$
ALL-PASS (See note 1.)	$\overline{DO16}$
ERROR (See note 2.)	$\overline{DO17}$
RUN (See note 3.)	$\overline{DO18}$
BUSY (See note 4.)	$\overline{DO19}$

Note 1: Will be turned ON when all measurement results are judged to be PASS for the already registered output numbers. This can be used for the comprehensive judgment. However, the OFF delay will not function.

Note 2: Will be turned ON if at least one of the measurement results is judged to be ERROR for the already registered output numbers. This can be used to identify that an error has occurred. However, the OFF delay will not function.

Note 3: Will be turned ON during measurement. Will be turned OFF while the scene is changed or set.

Note 4: Will be turned ON during Trigger measurement. Use this terminal to confirm whether or not the trigger is operating normally when self-trigger is set as the trigger input method.



All output terminals turn OFF when the mode is switched from Run Mode.



The initial signal of the output terminals is OFF. The terminals, however, may turn ON for approximately 0.5 s when the power is turned ON. Be sure to allow for this when connecting to an external device.

Timing Charts

Judgment output

Timing charts for the following 3 types of operation are given below.

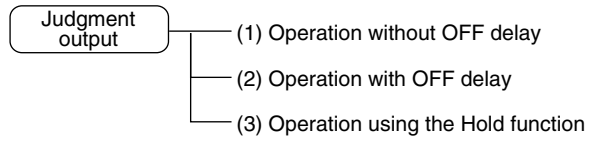

(1) Operation without OFF delay

Example: Output terminal for OUT0 (Judgment output A)

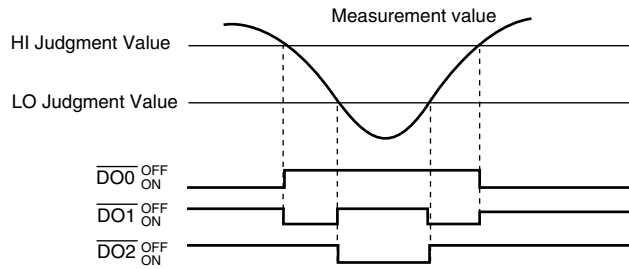

Note: The Gate signal is always OFF.

Output Terminals

Terminal	Function
$\overline{DO0}$	Functions as a HIGH terminal for OUT0.
$\overline{DO1}$	Functions as a PASS terminal for OUT0.
$\overline{DO2}$	Functions as a LOW terminal for OUT0.

(2) Operation with OFF delay

Example: Output terminal for OUT0 (Judgment output A)

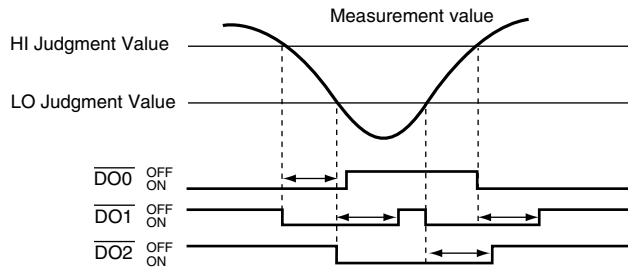

← : OFF Delay

Note: The Gate signal is always OFF.

Output Terminals

Terminal	Function
$\overline{DO0}$	Functions as a HIGH terminal for OUT0.
$\overline{DO1}$	Functions as a PASS terminal for OUT0.
$\overline{DO2}$	Functions as a LOW terminal for OUT0.

(3) Operation using the Hold function

Example: If Hold is set for some but not all outputs (Judgment output A)

Settings: OUT0 and OUT1: Hold set
OUT2 and OUT3: Hold not set

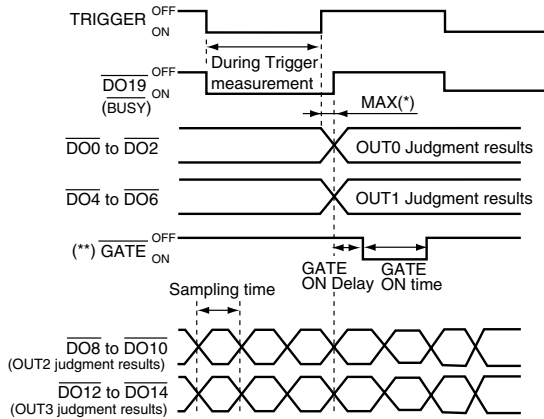

(*)... Sampling time max.

(**)... The GATE signal is output only for the terminals of output numbers for which Hold is set.

Output Terminals

Terminal	Function
$\overline{DO19}$	Functions as a BUSY signal. Indicates that the Z500 is performing Trigger measurement. If trigger function is set, this terminal can be used to confirm trigger operation.
$\overline{DO0}$	Functions as a HIGH terminal for OUT0.
$\overline{DO1}$	Functions as a PASS terminal for OUT0.
$\overline{DO2}$	Functions as a LOW terminal for OUT0.
$\overline{DO4}$	Functions as a HIGH terminal for OUT1.
$\overline{DO5}$	Functions as a PASS terminal for OUT1.
$\overline{DO6}$	Functions as a LOW terminal for OUT1.
\overline{GATE}	Used to control the timing with which measurement results are obtained by the external device. Turns ON for a time set so that the external device can obtain the judgment results of the output numbers for which Hold is set.
$\overline{DO8}$	Functions as a HIGH terminal for OUT2.
$\overline{DO9}$	Functions as a PASS terminal for OUT2.
$\overline{DO10}$	Functions as a LOW terminal for OUT2.
$\overline{DO12}$	Functions as a HIGH terminal for OUT3.
$\overline{DO13}$	Functions as a PASS terminal for OUT3.
$\overline{DO14}$	Functions as a LOW terminal for OUT3.
$\overline{DO3}, \overline{DO7}$ $\overline{DO11}, \overline{DO15}$	Function as error terminals for OUT0, OUT1, OUT2, and OUT3 respectively.

Input terminals

Terminal	Function
$\overline{TRIGGER}$	Inputs the measurement trigger from a sync sensor such as a photoelectric sensor.



Ensure that the TRIGGER turns ON while the GATE signal is OFF. If the TRIGGER turns ON while the GATE signal is ON (including at GATE ON delay), outputs may not operate properly.

7-2 RS-232C

The Z500 can perform no-protocol communications with an external device, such as a personal computer, via RS-232C. The same communications settings must be used on both the Z500 and the external device.

 **REFERENCE**

For details on setting communications specifications, refer to page 145.

 **CHECK**

Commands can be input only when the Z500 is in Run Mode. Do not use the terminal blocks for input or output during command execution.

At least 100 ms is required to output a measurement result after receiving a command via RS-232C.

Communications Overview

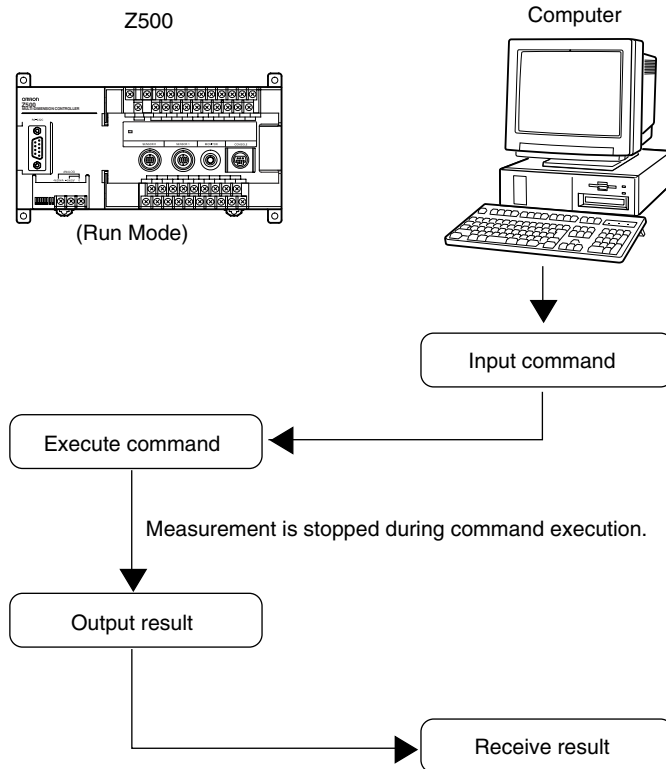

Command Formats

The following commands can be input from the host device to the Z500. Common commands have abbreviations that are shown in parentheses.

Commands that Obtain or Change Current Settings

Use the following commands to change settings or specify operations while reading the Z500 settings on the host side.

Command	Function	Page
AVE	Obtains or changes the averaging number.	162
JUDPARA	Obtains or changes the judgment upper limit and judgment lower limit.	163
SCENE	Obtains the scene number currently displayed.	165
	Changes the scene to be measured.	165
SENS	Sets the sensitivity adjustment method to Auto and obtains the optimum sensitivity for the workpiece.	166
	Sets the sensitivity adjustment method to Auto and changes the sensitivity level, turns the Laser OFF, and changes adjustments gradation.	166
SENSET	Sets a correction value.	167
	Clears a correction value.	167
SENSM	Sets the sensitivity adjustment method to Multi and obtains the optimum sensitivity for the workpiece.	168
	Sets the sensitivity adjustment method to Multi and changes the sensitivity level, turns the Laser OFF, and changes adjustments gradation.	168
ZERO	Executes Force-zero.	169
	Resets Force-zero.	170

Commands that Obtain Measurement Results

Command	Function	Page
JUDGE (J)	Obtains the most recent judgment result.	171
MEASURE (M)	Obtains the most recent measurement value.	172
TREND (T)	Obtains the measurement values from the start to the end of the measurement under the Trigger setting.	173
PROFILE (P)	Obtains the height distribution data (profile data) of 126 points.	175

Commands that Save and Load Data

Command	Function	Page
DATASAVE	Saves all data to flash memory.	176
SCNLOAD	Loads scene data from the host device.	176
SCNSAVE	Saves scene data to a host device.	177
SLANTLOAD	Loads correction values from the host device.	177
SLANTSAVE	Saves correction values to a host device.	178
SYSLOAD	Loads system data from the host device.	178
SYSSAVE	Saves system data to a host device.	179

Other

Command	Function	Page
VERGET	Obtains the system's version information.	179

Input Format

The commands are listed in alphabetical order. Input the commands in ASCII code. Either upper-case or lower-case characters can be input.

Example

JUDPARA <Output number> <H> delimiter

- ① Set numerical values for the items in < > brackets.
- ② Input a space between each parameter. (A space is not needed before the **delimiter**.)
- ③ Input the **delimiter** at the end of the command.

Output Format (Measurement value)

The measured values will be output with all of them closed to the right.

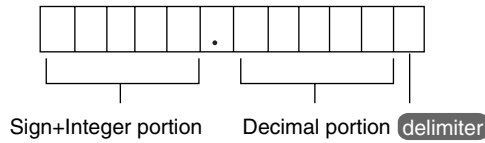

Example 1: 20.00000

□□□20.00000 delimiter

Spaces

Example 2: -20.00000

□□-20.00000 delimiter

Spaces

Note: "+" will not be output.

Commands that Obtain or Change Current Settings

- AVE

Function 1.....Obtains the averaging number.

Input	AVE	delimiter	
Output	Data obtained correctly		: Number delimiter
	Command not executed correctly		: ER delimiter

Example

Input	: AVE	delimiter
Output	: 4	delimiter
	The averaging number is 4.	

Function 2.....Changes the averaging number.

(The numbers of times that can be input are only 1, 2, 4, 8, 16, 32, 64, 128, and 256.)

Input	AVE <Number>	delimiter	
Output	Command executed correctly		: OK delimiter
	Command not executed correctly		: ER delimiter

Example

Input	: AVE 8	delimiter
Output	: OK	delimiter
	The averaging number is changed to 8.	

• JUDPARA

Function 1.....Obtains the judgment upper limit and the judgment lower limit.

Input JUDPARA <Output number> <Parameter> **delimiter**

- Specify an output number between 0 and 7.

Output number	Meaning
0	OUT0
1	OUT1
2	OUT2
3	OUT3
4	OUT4
5	OUT5
6	OUT6
7	OUT7

- The meaning of the parameters are as follows:

Parameter	Meaning
H	Judgment upper limit
L	Judgment lower limit

Output Data obtained correctly : Judgment value **delimiter**
 Command not executed correctly : ER **delimiter**

Example

Input : JUDPARA 0 H **delimiter**
 Obtains the judgment upper limit for OUT0.
Output : 5.0000 **delimiter**
 The upper limit is set to 5.0000.



The judgment upper limit and judgment lower limit for the currently displayed scene are obtained using this command. Display the required scene before execution.

Function 2.....Changes the judgment upper limit and judgment lower limit.

Input JUDPARA <Output number> <Judgment upper limit> <Judgment lower limit> **delimiter**

- Specify an output number between 0 and 7.

Output number	Meaning
0	OUT0
1	OUT1
2	OUT2
3	OUT3
4	OUT4
5	OUT5
6	OUT6
7	OUT7

- Set the limits so that the judgment upper limit is equal to or greater than the judgment lower limit. The setting range is -9999.99999 to 9999.99999.

Output Command executed correctly : OK **delimiter**
 Command not executed correctly : ER **delimiter**

Example

Input : JUDPARA 0 10.0000 -10.0000 **delimiter**
 Changes the judgment upper limit for OUT0 to 10.0000 and the judgment lower limit to -10.0000.
Output : OK **delimiter**



The judgment upper limit and judgment lower limit for the currently displayed scene are changed using this command. Display the required scene before execution.

• SCENE

Function 1.....Obtains the scene number of the scene being displayed.

Input SCENE delimiter
Output Command executed correctly : Scene Number delimiter
 Command not executed correctly : ER delimiter

Example

Input : SCENE delimiter
Output : 4 delimiter
 In this example, scene 4 is being displayed.

Function 2.....Changes the scene to be measured.

Input SCENE <Scene number> delimiter

- Specify a scene number between 0 and 15.

Output Command executed correctly : OK delimiter
 Command not executed correctly : ER delimiter

Example

Input : SCENE 2 delimiter
 In this example, the scene is switched to scene 2.
Output : OK delimiter

**CHECK**

If **Environment/Scene** in System Mode is set to **Terminals**, scenes cannot be switched using RS-232C commands. (ER is output.)

REFERENCE

Refer to page 146, *Environment Settings*.

• SENSET

Function 1.....Sets a correction value.

Input SENSET delimiter

Output Command executed correctly : OK delimiter

Command not executed correctly : ER delimiter



The correction value is set according to the sensor that has currently been used for the measurement (Sensor 0 or Sensor 1) and the measurement method (Wide or Zoom).

Example

Input : SENSET delimiter

The workpiece that has currently been measured is held horizontally, and the correction value is set.

Output : OK delimiter

Function 2.....Clears a correction value.

Input SENSET C delimiter

Output Command executed correctly : OK delimiter

Command not executed correctly : ER delimiter

Example

Input : SENSET C delimiter

The correction value is cleared.

Output : OK delimiter

Example

Input : SENS 18 24 160 **delimiter**
 The sensitivity level will be automatically adjusted to 18 to 24 so that a light receiving level of 160 is satisfied.
Output : OK **delimiter**

• ZERO

Function 1.....Executes Force-zero.

Input ZERO 0 <Output number> <Offset value> **delimiter**

- Specify an output number between 0 and 8.

Output number	Meaning
0	OUT0
1	OUT1
2	OUT2
3	OUT3
4	OUT4
5	OUT5
6	OUT6
7	OUT7
8	All zero

- Set the offset value used for Force-zero execution. Set the value to be added to 0 in the range -9999.99999 to 9999.99999. If this setting is omitted, the offset value that is already set will be used.

Output Command executed correctly : OK **delimiter**
 Command not executed correctly : ER **delimiter**

Example

Input : ZERO 0 1 **delimiter**
 Force-zero is executed for OUT1.
Output : OK **delimiter**

Function 2.....Resets Force-zero.

Input ZERO 1 <Output number> **delimiter**

- Specify an output number that is the same as the Function1 (between 0 and 8).

Output Command executed correctly : OK **delimiter**
Command not executed correctly : ER **delimiter**

Example

Input : ZERO 1 1 **delimiter**
Force-zero for OUT1 is reset.
Output : OK **delimiter**

Commands that Obtain Measurement Results

• JUDGE (or J)

FunctionObtains the most recent judgment result.

Input JUDGE (or J) <Output number> **delimiter**

- Specify an output number between 0 and 8.

Output number	Meaning
0	OUT0
1	OUT1
2	OUT2
3	OUT3
4	OUT4
5	OUT5
6	OUT6
7	OUT7
8	OUT0 to 7

Output Output number set to 0 to 7 : Judgment result **delimiter**
 Output number set to 8 : 0, Judgment result **delimiter**
 1, Judgment result **delimiter**
 2, Judgment result **delimiter**
 ⋮
 OK **delimiter**
 Other errors : ER **delimiter**
 LD-OFF : LDOFF **delimiter**
 Measurement not possible : RST **delimiter**

- The following judgment result will be output from the Z500.

Output number	Meaning
0	PASS
1	HIGH
2	LOW
3	ERROR

Example

Input : J 1 **delimiter**
 The judgment result for OUT1 is obtained.
Output : 0 **delimiter**
 The judgment result is within the judgment value range (PASS).



The most recent judgment result for the currently displayed scene is output.

• MEASURE (or M)

Function.....Obtains the most recent measurement value.

Input MEASURE (or M) <Output number> **delimiter**

- Specify an output number between 0 and 8.

Output number	Meaning
0	OUT0
1	OUT1
2	OUT2
3	OUT3
4	OUT4
5	OUT5
6	OUT6
7	OUT7
8	OUT0 to 7

Output Output number set to 0 to 7 : Measurement value **delimiter**
 Output number set to 8 : 0, Measurement value **delimiter**
 1, Measurement value **delimiter**
 2, Measurement value **delimiter**
 ⋮
 OK **delimiter**
 Measurement error : -9999.99999 **delimiter**
 Other errors : ER **delimiter**
 LD-OFF : LDOFF **delimiter**
 Measurement not possible : RST **delimiter**

Example

Input : M 1 **delimiter**
 The most recent measurement value for OUT1 is obtained.
Output : 111.1111 **delimiter**
 The measurement value is 111.1111.



The number of output digits has no relation to the setting for the number of display digits set to **Environment/Dec. pts** in System Mode. (Only negative results are output with a sign.)



Refer to page 146, *Environment Settings*.



The most recent measurement result for the currently displayed scene is output.

• TREND (or T)

Function.....Obtains the measurement values from the start to the end of the measurement under the Trigger setting.



CHECK

Perform the setting as shown below, before using the command.
Set the trigger input method to **External** or **Self**.



REFERENCE

For details on the Trigger function, refer to page 90.



REFERENCE

For details on how to set the Trend Monitor's display contents, refer to page 118.

TREND (or T) <Output number> <Output coefficient>

- Specify an output number between 0 and 7.

Output number	Meaning
0	OUT0
1	OUT1
2	OUT2
3	OUT3
4	OUT4
5	OUT5
6	OUT6
7	OUT7

- Specify an output coefficient between 1 and 1,000.
- The output coefficient is the number of intervals between measurements that are output.
- The number of data items that will be output can be calculated using the formula below.

Measurement time ÷ Sampling time = Number of measurements

Number of measurements ÷ Measurement coefficient = Number of data items output (The number is rounded up to the nearest integer.)

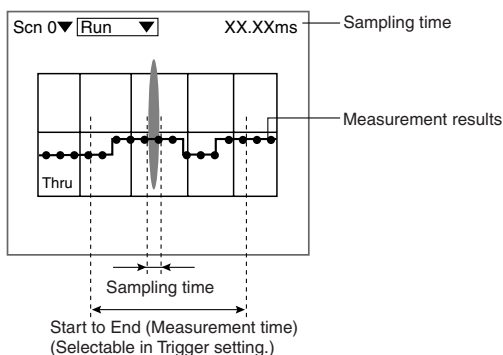

```

(Output) Command executed correctly: Number of data items delimiter
                                           : Measurement time (s)
                                           Measurement value delimiter
                                           : (Number of data items)
                                           Measurement value
                                           OK delimiter
Measurement error : -9999.99999 delimiter
Other errors      : ER delimiter
(Free is set to Trigger setting.)
No trigger occurred : RST delimiter
LD-OFF            : LDOFF delimiter
    
```

Example

The following example is for a measurement time of 1,000 ms, a sampling time of 9.96 ms, and an output coefficient of 2.

```

(Input) : TREND 0 2 delimiter
    
```

The measurement results for OUT0 are obtained.

```

(Output) : 50 delimiter ----- Number of data items
          1.0 delimiter ----- Measurement time (s)
          253.5311 delimiter
          497.5759 delimiter
          :
          :
          369.9789 delimiter
          OK delimiter
    
```

1,000 ms ÷ 9.96 ms ÷ 2 = 50 measurement results are output.

• PROFILE (or P)

Function.....Obtains the height distribution data (profile data) of 126 points.

Input : PROFILE (or P) delimiter

Output : Command executed correctly : Measurement value for 0 line
 delimiter
 :
 Measurement value for 125 lines
 delimiter
 OK delimiter

Command not executed correctly

Other errors : ER delimiter

LD-OFF : LDOFF delimiter

Example

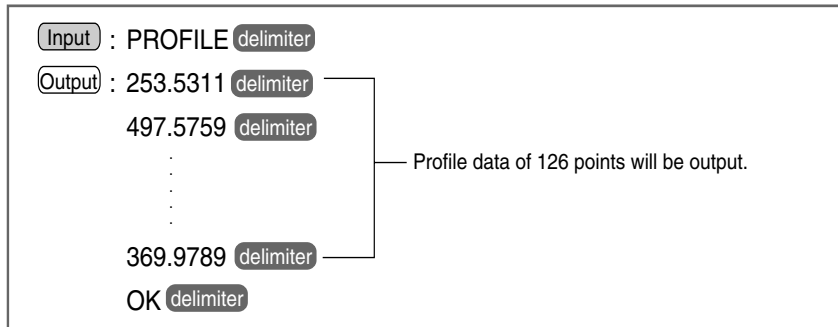

Commands that Save and Load Data

• DATASAVE

Function.....Saves all data to flash memory.

Input DATASAVE **delimiter**
Output Command correctly saved : OK **delimiter**
Command not correctly saved : ER **delimiter**



NOTICE

Do not turn OFF the Z500's power until a response has been received.

• SCNLOAD

Function.....Loads scene data from the host device to the Z500.

Input SCNLOAD <Scene number> **delimiter**

- Specify a scene number between 0 and 15. If no scene number is specified, the data is loaded to the currently displayed scene.
- The data transfer is performed with XMODEM(-CRC or SUM) protocol. The XMODEM(-1K) protocol is not supported.
- The Z500 sends a READY signal to the host device when the Z500 has completed its initialization. Wait for the READY signal to be received at the host device before starting the data transfer.

Output Data correctly loaded : OK **delimiter**
Data not correctly loaded : ER **delimiter**

Example

Input : SCNLOAD 2 **delimiter**
Data will be loaded to scene 2 from a host device.
Output : OK **delimiter**

• SCNSAVE

Function.....Saves scene data to a host device.

Input SCNSAVE <Scene number> **delimiter**

- Specify a scene number between 0 and 15. If no scene number is specified, the scene data displayed currently is saved to the host device.
- The data transfer is performed with XMODEM(-CRC or SUM) protocol. The XMODEM(-1K) protocol is not supported.
- The Z500 sends a READY signal to the host device when the Z500 has completed its initialization. Wait for the READY signal to be received at the host device before starting the data transfer.

Output Data correctly saved : OK **delimiter**
Data not correctly saved : ER **delimiter**

Example

Input : SCNSAVE 2 **delimiter**
This example saves the scene 2 scene data to the host device.
Output : OK **delimiter**

• SLANTLOAD

Function.....Loads correction values from the host device.

Input SLANTLOAD **delimiter**

- The data transfer is performed with XMODEM(-CRC or SUM) protocol. The XMODEM (-1K) protocol is not supported.
- The Z500 sends a READY signal to the host device when the Z500 has completed its initialization. Wait for the READY signal to be received at the host device before starting the data transfer.
- The following four types of data will be loaded in block.
 - For Sensor 0 (Wide) - For Sensor 0 (Zoom)
 - For Sensor 1 (Wide) - For Sensor 1 (Zoom)

Output Data correctly loaded : OK **delimiter**
Data not correctly loaded : ER **delimiter**

Example

Input : SLANTLOAD **delimiter**
Correction values will be loaded from the host device.
Output : OK **delimiter**

• **SLANTSAVE**

Function.....Saves correction values to a host device.

Input SLANTSAVE **delimiter**

- The data transfer is performed with XMODEM(-CRC or SUM) protocol. The XMODEM(-1K) protocol is not supported.
- The Z500 sends a READY signal to the host device when the Z500 has completed its initialization. Wait for the READY signal to be received at the host device before starting the data transfer.
- The following four types of data will be saved in block.
 - For Sensor 0 (Wide) - For Sensor 0 (Zoom)
 - For Sensor 1 (Wide) - For Sensor 1 (Zoom)

Output Command executed correctly : OK **delimiter**
 Command not executed correctly : ER **delimiter**

Example

Input : SLANTSAVE **delimiter**
 Correction values will be saved to the host device.
Output : OK **delimiter**

• **SYSLOAD**

Function.....Loads system data from a host device to the Z500.

Input SYSLOAD **delimiter**

- The data transfer is performed with XMODEM(-CRC or SUM) protocol. The XMODEM(-1K) protocol is not supported.
- The Z500 sends a READY signal to the host device when the Z500 has completed its initialization. Wait for the READY signal to be received at the host device before starting the data transfer.

Output Data correctly loaded : OK **delimiter**
 Data not correctly loaded : ER **delimiter**

Example

Input : SYSLOAD **delimiter**
 This example loads the system data from the host device.
Output : OK **delimiter**

• SYSSAVE

Function.....Saves system data to a host device.

Input SYSSAVE **delimiter**

- The data transfer is performed with XMODEM(-CRC or SUM) protocol. The XMODEM(-1K) protocol is not supported.
- The Z500 sends a READY signal to the host device when the Z500 has completed its initialization. Wait for the READY signal to be received at the host device before starting the data transfer.

Output Data correctly saved : OK **delimiter**
Data not correctly saved : ER **delimiter**

Example

Input : SYSSAVE **delimiter**
This example saves the system data to the host device.
Output : OK **delimiter**

Other

• VERGET

Function.....Obtains the system's version information.

Input VERGET **delimiter**

Output Data obtained correctly : Version information **delimiter**
Data not obtained correctly : ER **delimiter**

Example

Input : VERGET **delimiter**
The system's version information is obtained.
Output : Z500-MC10(M)VerX.XX(S)VerX.XX(F)X.XX **delimiter**

7-3 Analog Output

Measurement results can be output as current in the range 4 to 20 mA and as voltage in the range -5 to 5 V.

 **REFERENCE**

For details on setting output contents, refer to page 100.

 **CHECK**

Output During Reset Input

During restart (approx. 20 s after power is turned ON), 0 V and 12 mA are output to the analog output terminals. Ensure that these outputs are not treated as actual signals at external devices.

Outputting Measurement Values

When output numbers **OUT0** through **OUT7** have been set to **Output**, the measured values will be output.

Outputting the Profile

When **Profile** has been set to **Output**, the analog signals of the profile (height distribution of 126 points) will be output.

By inputting analog output signals to a personal computer via an A/D converter, profiles can be measured in terms of height distribution.

Connection Example

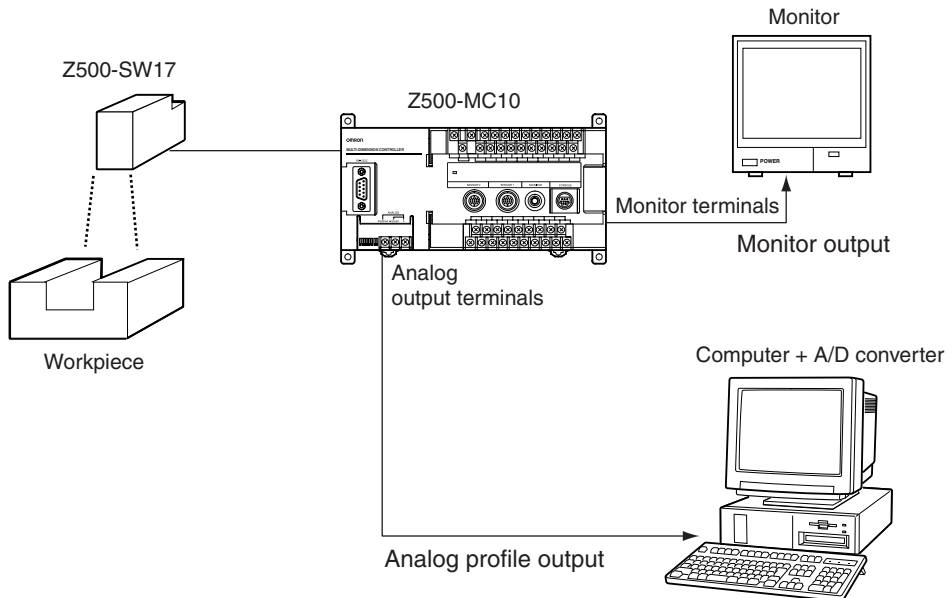

Signal Outputting Timing

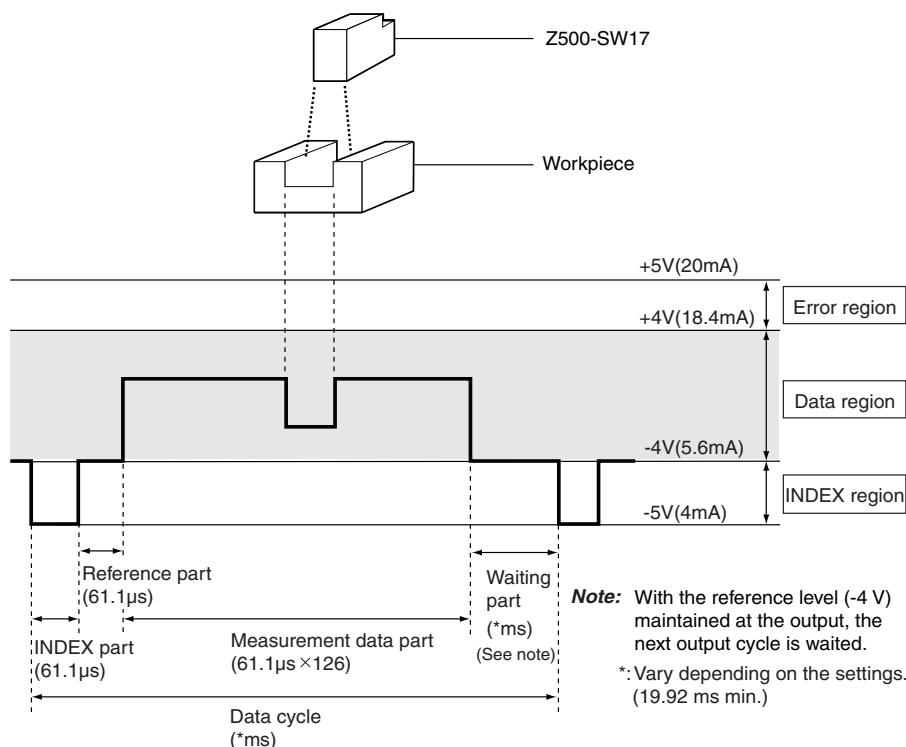

The data are converted to voltages in a range (data region) of -4 to +4 V depending on height, and are output.

Either one of **F.S.**, **1/2 F.S.** or **1/4 F.S.** can be selected for the height measurement result.

REFERENCE

Refer to page 101.

The measurement range of the height varies depending on the Sensors connected.

Example

Output level of Z500-SW17 (a height measurement range of -20 to +20 mm) and the corresponding height measurement results

Output level	Corresponding height measurement results		
	F.S. output	1/2 F.S. output	1/4 F.S. output
+4V (18.4mA)	+20mm	+10mm	+5mm
0V (12mA)	0mm	0mm	0mm
-4V (5.6mA)	-20mm	-10mm	-5mm

If an error occurs, +5 V will be output.

MEMO

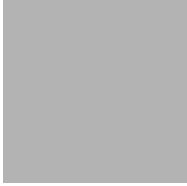

SECTION 8

Troubleshooting

This section lists the errors that may occur during Z500 operation. If an error occurs, check the items described in this section before consulting your OMRON representative.

8-1 Troubleshooting

184

8-1 Troubleshooting

This section lists the errors that may occur during Z500 operation, along with their probable causes and remedies.

The letters used in the reference page column represent the following reference materials:

Setup: Setup Manual

Operation: Operation Manual (this manual)

Error message	Causes and remedies	Reference
No edge detected. Redo settings.	- Is the workpiece inside the measurement range? - Is the measurement performed correctly? Check this on the image monitor screen. Reason The edge to be determined as the reference position could not be found during reference registration.	Setup: page 28 Operation: page 30
Environment is set to select scenes via terminal block.	Using the System/Environment screen check if Scene has been set correctly. Reason An error has occurred in Scene .	Operation: page 146
The reference height and position have been updated. Check the settings for measurement items.	Check whether the setting contents of the measurement items are correct. Reason The reference was registered after the measurement items had been set. When using the position compensation function, set Compensatn and Meas set in this order.	Operation: page 70
Too many items to register. Perform registration after deleting unnecessary items.	Delete all unnecessary measurement items, and then set the necessary items again. Reason The number of measurement points exceeds the allowable limit of the Z500.	Operation: page 87
No measurement point detected. Redo settings.	- Is the workpiece inside the measurement range? - Is the measurement performed correctly? Check this on the image monitor screen. Reason The edge to be determined as the reference position could not be found during reference registration.	Setup: page 28 Operation: page 30
Meas method will be changed. All scene data will be cleared.	Data integration cannot be ensured when the measurement method is changed. All settings for scene data are returned to their default settings.	—
No more functions settable. Redo the settings.	Change the setting of unnecessary functions. Example - Set Conditions/Details/Profile to None . - Set the position compensation to None . - Delete all unnecessary measurement items. - Delete Output/Analog/Profile .	Operation: page 96 Operation: page 64 Operation: page 70 Operation: page 100

Error message	Causes and remedies	Reference
No Sensor connected.	Turn OFF the power supply, and then restart the Z500 after confirming the following points. - Are the Sensor Cables connected to the Z500? - Is the Sensor Cable disconnected from the Sensor?	Setup: page 18
Sensor connection status has changed. Click Continue and all settings will be set to their default values.	To return to the previous connection status: Turn OFF the power supply, and then restart the Z500 after confirming the following points. - Check that the same model of Sensors are connected. - Check that the same number of Sensors are connected. To change the connection status: Select Continue . The settings are initialized.	—
Changing sens. installation initializes all scene data. OK?	Data integration cannot be ensured when the Sensor mounting method is changed. All settings for scene data are returned to their default settings.	—
Downloaded data is invalid. Data will be loaded from sensor.	Although the download function is ON, the sensor information has not been downloaded to the controller. Download the sensor information using System/Download .	Operation: page 148
Measurement is not possible. Reset the reference.	After checking the reference condition of installation, perform the settings again. Reason Reliable measurement cannot be assured, and this will prevent setting of a value for installation error compensation.	Operation: page 149
Measurement is not possible. Reset the reference workpiece.	Check whether or not the workpiece is inside the measurement range. Reason A measurement error occurred when workpieces were measured for calibration.	Setup: page 28
Adjustment range exceeded. Calibration is not possible.	Perform calibration again so that the span and offset are within the range for which compensation is possible. Reason The span and offset are beyond the range for which compensation is possible and calibration cannot be performed.	Operation: page 78
Communication error.	Stop operating the Z500 and turn OFF the power supply, and attempt to operate again after confirming the following items. - Is the cable wired correctly? - Are the communications settings the same as those of the external device? - Is the external device operated correctly? Reason Transfer between the Z500 and an external device was interrupted because a communications error occurred. If the same error occurs after confirming the above items, it is possible that the Z500 is broken.	Setup: page 44 Operation: page 145
Communication data is wrong.	Select the correct transfer file and re-execute the data transfer. Reason The wrong file has been selected.	—
Sensor not supported.	Check whether or not the model of Sensors is connectable. Reason An unconnectable Sensor has been used.	Setup: page 18

Error message	Causes and remedies	Reference
Calibration is not possible for user definitions. Set using span and offset in output conditions.	Compensate the data by setting <i>Output/Span</i> and <i>Output/Offset</i> . Reason <i>Calibrate</i> cannot be set in <i>Define</i> .	Operation: page 84
The horizontal axis setting exceeds 10 seconds. Profile monitoring is not possible.	Set the horizontal setting time to 10 s or less to display a shaded 3-D image. Reason The maximum display time of the Profile Monitor is 10 s.	Operation: page 135

INDEX

Numbers

1st scene 146

A

Adjusting images 56
Adjustment menu 28
Analog output 100, 180
AVE 162
Average Hold 84
Averaging number 88

B

Backup 136
Bottom Hold 84

C

Calibration 78
Changing menus 146
Changing scenes 125
Changing to a different measurement setup 125
Clearing scenes 127
Communications specifications 145
Console 23
Conversational Menu 39
Copying scene data 126

D

DATASAVE 176
Dec. pts 146
Define 71
Details setting 96
Digital Monitor 35, 117

E

Edge center 71
Edge detection hysteresis width 97
Edge position 70, 74
Enlarging display 113
Environment settings 146
Equation 76
Error data 98
Expert Menu 53
External trigger 90

F

Force-zero 110
Free run 90

G

GATE 103,157,158

H

Height 70
Hold setting 84
Horizontal setting 118, 121
Hysteresis 97

I

Image Monitor 30, 113
Initialize 151
Inputting values 27

J

JUDGE 171
Judgement value hysteresis width 97
JUDPARA 163

L

Line brightness display 31, 116

M

MEASURE 172
Measurement conditions 88
Measurement level 96
Measurement methods 56
Measurement settings 70
Menus 5
Moving Cursor 116, 124
Multi 44,59

N

Noise removal 97

O

OFF Delay Time 103, 157
Offset 84
Output settings 50,100

P

Peak Hold 84

Peak/bottom measurement width 99
Peak-peak Hold 84
Personal computer 136
Position compensation 64
PROFILE 175
Profile display 34
Profile Monitor 33, 121
Profile output 100, 180

R

Resetting display 115
RS-232C 105,159

S

Sampling Hold 84
Save 37, 52, 108, 136
SCENE 165
Scene data 136
SCNLOAD 176
SCNSAVE 177
Self trigger 90
SENS 166
SENSET 167
SENSM 168
Sensitivity adjustment 59
Sensitivity details 63
Setting measurement regions 58
Smoothing 97
Span 84
Startup monitor 146
Step: 2 pts 70,72
Step: 3 pts 70
Surrounding image 135
SYSLOAD 178
SYSSAVE 179
System data 136

T

Terminal block output 103, 155
Test measurement 129
Thru 118, 121
Timing charts 157
TREND 173
Trend Monitor 36, 118
Trigger 118, 121
Trigger setting 90

V

VERGET 179
Version 152
Vertical setting 118, 121

W

Width 71

Z

ZERO 169

Revision History

A manual revision code appears as a suffix to the catalog number on the front cover of the manual.

Cat. No. Z159-E1-2



Revision code

The following table outlines the changes made to the manual during each revision. Page numbers refer to the previous version.

Revision code	Date	Revised content
1	February 2002	Original production
2	January 2003	Added Z500-SW6 Sensor Head, and Download function.