

UHF RFID System V780-series Reader/Writer

User's Manual

Standard Reader/Writer

V780-HMD68-ETN-JP
V780-HMD68-ETN-KR
V780-HMD68-ETN-CN
V780-HMD68-ETN-TW
V780-HMD68-ETN-IN
V780-HMD68-ETN-ID
V780-HMD68-ETN-MY
V780-HMD68-ETN-SG
V780-HMD68-ETN-EU
V780-HMD68-ETN-RU
V780-HMD68-ETN-US
V780-HMD68-ETN-MX

Slave Reader/Writer

V780-HMD68-ETN-JP-S
V780-HMD68-ETN-KR-S
V780-HMD68-ETN-CN-S
V780-HMD68-ETN-TW-S
V780-HMD68-ETN-IN-S
V780-HMD68-ETN-ID-S
V780-HMD68-ETN-MY-S
V780-HMD68-ETN-SG-S
V780-HMD68-ETN-EU-S
V780-HMD68-ETN-RU-S
V780-HMD68-ETN-US-S
V780-HMD68-ETN-MX-S



NOTE

All rights reserved. No part of this publication may be reproduced, stored in a retrieval system, or transmitted, in any form, or by any means, mechanical, electronic, photocopying, recording, or otherwise, without the prior written permission of OMRON.

No patent liability is assumed with respect to the use of the information contained herein. Moreover, because OMRON is constantly striving to improve its high-quality products, the information contained in this manual is subject to change without notice. Every precaution has been taken in the preparation of this manual. Nevertheless, OMRON assumes no responsibility for errors or omissions. Neither is any liability assumed for damages resulting from the use of the information contained in this publication.

Trademarks

- Microsoft, Windows, Edge, Internet Explorer are either registered trademarks or trademarks of Microsoft Corporation in the USA and other countries.
- Modbus® is a registered trademark of Schneider Electric.
- Java and other trademarks that contain "Java" are the registered trademarks of Oracle Corporation or its related companies.
- Google Chrome is trademarks or registered trademarks of Google LLC.

Other company names and product names in this document are the trademarks or registered trademarks of their respective companies.

Copyrights

Microsoft product screen shots reprinted with permission from Microsoft Corporation.

Introduction

Thank you for purchasing a V780-HMD68-ETN-□□/V780-HMD68-ETN-□□-S RFID System. This manual contains information that is necessary to use the V780-HMD68-ETN-□□/V780-HMD68-ETN-□□-S. Please read this manual and make sure you understand the functionality and performance of the Reader/Writer before you attempt to use it in an RFID system.

Keep this manual in a safe place where it will be available for reference during operation.

Intended Audience

This manual is intended for the following personnel, who must also have knowledge of electrical systems (an electrical engineer or the equivalent).

- Personnel in charge of introducing FA systems
- Personnel in charge of designing FA systems
- Personnel in charge of installing and connecting FA systems
- Personnel in charge of managing FA systems and facilities

Applicable Products

This manual covers the following products.

- V780-series Reader/Writers for UHF RFID Systems for 920-MHz-band Moving Object Differentiation Wireless Facilities
 - V780-HMD68-ETN-JP/V780-HMD68-ETN-JP-S
 - V780-HMD68-ETN-KR/V780-HMD68-ETN-KR-S
 - V780-HMD68-ETN-CN/V780-HMD68-ETN-CN-S
 - V780-HMD68-ETN-TW/V780-HMD68-ETN-TW-S
 - V780-HMD68-ETN-IN/V780-HMD68-ETN-IN-S
 - V780-HMD68-ETN-ID/V780-HMD68-ETN-ID-S
 - V780-HMD68-ETN-MY/V780-HMD68-ETN-MY-S
 - V780-HMD68-ETN-SG/V780-HMD68-ETN-SG-S
 - V780-HMD68-ETN-EU/V780-HMD68-ETN-EU-S
 - V780-HMD68-ETN-RU/V780-HMD68-ETN-RU-S
 - V780-HMD68-ETN-US/V780-HMD68-ETN-US-S
 - V780-HMD68-ETN-MX/V780-HMD68-ETN-MX-S

Terms and Conditions Agreement

Warranty, Limitations of Liability

Warranties

- **Exclusive Warranty**

Omron's exclusive warranty is that the Products will be free from defects in materials and workmanship for a period of twelve months from the date of sale by Omron (or such other period expressed in writing by Omron). Omron disclaims all other warranties, express or implied.

- **Limitations**

OMRON MAKES NO WARRANTY OR REPRESENTATION, EXPRESS OR IMPLIED, ABOUT NON-INFRINGEMENT, MERCHANTABILITY OR FITNESS FOR A PARTICULAR PURPOSE OF THE PRODUCTS. BUYER ACKNOWLEDGES THAT IT ALONE HAS DETERMINED THAT THE PRODUCTS WILL SUITABLY MEET THE REQUIREMENTS OF THEIR INTENDED USE.

Omron further disclaims all warranties and responsibility of any type for claims or expenses based on infringement by the Products or otherwise of any intellectual property right.

- **Buyer Remedy**

Omron's sole obligation hereunder shall be, at Omron's election, to (i) replace (in the form originally shipped with Buyer responsible for labor charges for removal or replacement thereof) the non-complying Product, (ii) repair the non-complying Product, or (iii) repay or credit Buyer an amount equal to the purchase price of the non-complying Product; provided that in no event shall Omron be responsible for warranty, repair, indemnity or any other claims or expenses regarding the Products unless Omron's analysis confirms that the Products were properly handled, stored, installed and maintained and not subject to contamination, abuse, misuse or inappropriate modification. Return of any Products by Buyer must be approved in writing by Omron before shipment. Omron Companies shall not be liable for the suitability or unsuitability or the results from the use of Products in combination with any electrical or electronic components, circuits, system assemblies or any other materials or substances or environments. Any advice, recommendations or information given orally or in writing, are not to be construed as an amendment or addition to the above warranty.

See <http://www.omron.com/global/> or contact your Omron representative for published information.

Limitation on Liability; Etc

OMRON COMPANIES SHALL NOT BE LIABLE FOR SPECIAL, INDIRECT, INCIDENTAL, OR CONSEQUENTIAL DAMAGES, LOSS OF PROFITS OR PRODUCTION OR COMMERCIAL LOSS IN ANY WAY CONNECTED WITH THE PRODUCTS, WHETHER SUCH CLAIM IS BASED IN CONTRACT, WARRANTY, NEGLIGENCE OR STRICT LIABILITY.

Further, in no event shall liability of Omron Companies exceed the individual price of the Product on which liability is asserted.

Application Considerations

Suitability of Use

Omron Companies shall not be responsible for conformity with any standards, codes or regulations which apply to the combination of the Product in the Buyer's application or use of the Product. At Buyer's request, Omron will provide applicable third party certification documents identifying ratings and limitations of use which apply to the Product. This information by itself is not sufficient for a complete determination of the suitability of the Product in combination with the end product, machine, system, or other application or use. Buyer shall be solely responsible for determining appropriateness of the particular Product with respect to Buyer's application, product or system. Buyer shall take application responsibility in all cases.

NEVER USE THE PRODUCT FOR AN APPLICATION INVOLVING SERIOUS RISK TO LIFE OR PROPERTY WITHOUT ENSURING THAT THE SYSTEM AS A WHOLE HAS BEEN DESIGNED TO ADDRESS THE RISKS, AND THAT THE OMRON PRODUCT(S) IS PROPERLY RATED AND INSTALLED FOR THE INTENDED USE WITHIN THE OVERALL EQUIPMENT OR SYSTEM.

Programmable Products

Omron Companies shall not be responsible for the user's programming of a programmable Product, or any consequence thereof.

Disclaimers

Performance Data

Data presented in Omron Company websites, catalogs and other materials is provided as a guide for the user in determining suitability and does not constitute a warranty. It may represent the result of Omron's test conditions, and the user must correlate it to actual application requirements. Actual performance is subject to the Omron's Warranty and Limitations of Liability.

Change in Specifications

Product specifications and accessories may be changed at any time based on improvements and other reasons. It is our practice to change part numbers when published ratings or features are changed, or when significant construction changes are made. However, some specifications of the Product may be changed without any notice. When in doubt, special part numbers may be assigned to fix or establish key specifications for your application. Please consult with your Omron's representative at any time to confirm actual specifications of purchased Product.

Errors and Omissions

Information presented by Omron Companies has been checked and is believed to be accurate; however, no responsibility is assumed for clerical, typographical or proofreading errors or omissions.

Safety Precautions

Definition of Precautionary Information



The following notation and alert symbols are used in this User's Manual to provide precautions required to ensure safe usage of the V780-HMD68-ETN-□□/ V780-HMD68-ETN-□□-S Reader/Writer.

The safety precautions that are provided are extremely important to safety. Always read and heed the information provided in all safety precautions.



The following notation is used.











 <b style="font-size: 24px; margin-left: 10px;">WARNING	<p>Indicates a potentially hazardous situation which, if not avoided, will result in minor or moderate injury, or may result in serious injury or death. Additionally there may be significant property damage.</p>
--	---

Alert Symbols

	<p>The triangle symbol indicates precautions (including warnings). The specific operation is shown in the triangle and explained in text. This example on the left indicates a general precaution.</p>
	<p>The filled circle symbol indicates operations that you must do. The specific operation is shown in the circle and explained in text. This example on the left shows a general precaution for something that you must do.</p>

Warnings

 <b style="font-size: 24px; margin-left: 10px;">WARNING	
The V780-HMD68-ETN-JP/V780-HMD68-ETN-JP-S can be used only in Japan.	
The V780-HMD68-ETN-KR/V780-HMD68-ETN-KR-S can be used only in Korea.	
The V780-HMD68-ETN-CN/V780-HMD68-ETN-CN-S can be used only in China.	
The V780-HMD68-ETN-TW/V780-HMD68-ETN-TW-S can be used only in Taiwan.	
The V780-HMD68-ETN-IN/V780-HMD68-ETN-IN-S can be used only in India.	

The V780-HMD68-ETN-ID/V780-HMD68-ETN-ID-S can be used only in Indonesia.	
The V780-HMD68-ETN-MY/V780-HMD68-ETN-MY-S can be used only in the Malaysia.	
The V780-HMD68-ETN-SG/V780-HMD68-ETN-SG-S can be used only in Singapore and Thailand.	
The V780-HMD68-ETN-EU/V780-HMD68-ETN-EU-S can be used in the European countries under the RE Directive (2014/53/EU).	
The V780-HMD68-ETN-RU/V780-HMD68-ETN-RU-S can be used only in Russia.	
The V780-HMD68-ETN-US/V780-HMD68-ETN-US-S can be used only in the United States and Canada.	
The V780-HMD68-ETN-MX/V780-HMD68-ETN-MX-S can be used only in the Mexico.	
Anti-virus protection	
Install the latest commercial-quality antivirus software on the computer connected to the control system and maintain to keep the software up-to-date.	
Security measures to prevent unauthorized access	
Take the following measures to prevent unauthorized access to our products.	
<ul style="list-style-type: none"> • Install physical controls so that only authorized personnel can access control systems and equipment. • Reduce connections to control systems and equipment via networks to prevent access from untrusted devices. • Install firewalls to shut down unused communications ports and limit communications hosts and isolate control systems and equipment from the IT network. • Use a virtual private network (VPN) for remote access to control systems and equipment. • Adopt multifactor authentication to devices with remote access to control systems and equipment. • Set strong passwords and change them frequently. • Scan virus to ensure safety of USB drives or other external storages before connecting them to control systems and equipment. 	
Data input and output protection	
Validate backups and ranges to cope with unintentional modification of input/output data to control systems and equipment.	
<ul style="list-style-type: none"> • Checking the scope of data • Checking validity of backups and preparing data for restore in case of falsification and abnormalities • Safety design, such as emergency shutdown and fail-soft operation in case of data tampering and abnormalities 	
Data recovery	
Backup data and keep the data up-to-date periodically to prepare for data loss.	

When using an intranet environment through a global address, connecting to a SCADA or an unauthorized terminal such as an HMI or to an unauthorized server may result in network security issues such as spoofing and tampering. You must take sufficient measures such as restricting access to the terminal, using a terminal equipped with a secure function, and locking the installation area by yourself.



When constructing an intranet, communication failure may occur due to cable disconnection or the influence of unauthorized network equipment. Take adequate measures, such as restricting physical access to network devices, by means such as locking the installation area.



When using a device equipped with the SD Memory Card function, there is a security risk that a third party may acquire, alter, or replace the files and data in the removable media by removing the removable media or unmounting the removable media. Please take sufficient measures, such as restricting physical access to the Controller or taking appropriate management measures for removable media, by means of locking the installation area, entrance management, etc., by yourself.



Falling when working in high locations may result in injury. Do not work anywhere that the footing is not stable.



Injury may occur if the Reader/Writer falls and strikes a person. Observe the following precautions when installing the Reader/Writer.

- Do not work when there are persons below you.
- Observe all torque specifications for bolts.



Precautions for Safe Use

Observe the following precautions to ensure safety.

Transportation

- The Reader/Writer may be damaged if it falls from a high location. When you transport Reader/Writers, do not stack them too high.
- Injury may occur if the Reader/Writer falls. Do not let the Reader/Writer fall when you carry it.

Installation and Removal

- The Reader/Writer weighs approx. 3 kg. It may be damaged if it falls. Use slip-resistant gloves when you install the Reader/Writer and hold the Reader/Writer securely at the depressions with both hands.

Wiring

- The Reader/Writer may be damaged. Wire it correctly.
- The cables may break. Confirm cable specifications and do not bend cables past their normal bending radius.
- The Reader/Writer may be damaged. Never use an AC power supply.
- Connect the Ethernet cable to a host device (e.g., Switching Hub or PLC) that supports STP and ground the host device to a ground resistance of 100 Ω or less.

Usage

- The communications range depends on the operating and installation environment. Use the Reader/Writer only after sufficiently testing operation onsite.
- If multiple Reader/Writers are installed near each other, communications distances may decrease due to mutual interference. Refer to *A-5 Mutual Interference of Reader/Writers (Reference Only)* on page A-25 and check to make sure there is no mutual interference between Reader/Writers.

Errors and Failures

- If an error is detected in the Reader/Writer, immediately stop operation and turn OFF the power supply. Consult with an OMRON representative.

Maintenance

- Using thinner, benzene, acetone, or kerosene may adversely affect the plastic parts and case coating. Refer to *A-6 Chemical Resistance of the Reader/Writers* on page A-29 and do not use any chemicals that would have a negative effect.

Disposal

- Dispose of the Reader/Writer as industrial waste.

Precautions for Correct Use

Always observe the following precautions to prevent operation failures, malfunctions, and adverse effects on performance and equipment.

Transportation

- Always use the packing box that comes with the Reader/Writer when you transport it, and do not subject it to excessive vibration or shock.

Installation

- After you tighten the bolts, make sure that the Reader/Writer is securely attached.
- In V780-HMD68-ETN-IN/-EU/-RU/-IN-S/-EU-S/-RU-S, attach the supplied ferrite core to the power cable and Ethernet cable before use.

Installation and Storage Environment

Do not use or store the Reader/Writer in the following locations.

- Locations subject to combustible gases, explosive gases, corrosive gases, dust, dirt, metal powder, or salt
- Locations where the specified ambient temperature or ambient humidity range is exceeded
- Locations subject to extreme temperature changes that may result in condensation
- Locations where the Reader/Writer would be directly subjected to vibration or shock exceeding specifications
- Locations subject to water exposure that exceeds the specifications

Storage Methods

- Injury or damage may occur if the Reader/Writer falls. Implement safety measures so that the Reader/Writer will not fall.

Wiring

- To use the Reader/Writer in Run Mode, connect the control signal to +24 VDC of the power supply. If you connect the control signal to the 0-V side of the power supply, the Reader/Writer will start in Safe Mode.
- The Reader/Writer may be destroyed. Do not exceed the rated voltage range.

Usage

- The Reader/Writer may fail if it is used with a damaged cable. Do not subject the cable to strong forces or place heavy objects on the cable.
- Observe the tightening torque specifications for the power supply and communications connectors.
- The Reader/Writer may fail or become unreliable if heat cannot be dissipated sufficiently. Ensure that heat can be dissipated around the Reader/Writer.
- Do not use the Reader/Writer outdoors.
- Do not attempt to disassemble, repair, or modify the Reader/Writer.

Maintenance

- Perform inspections both daily and periodically.
- The Reader/Writer may fail if it or its wiring is replaced while the power supply is ON. Always turn OFF the power supply before you replace the Reader/Writer or its wiring.

Compliance with Laws and Regulations

- V780-HMD68-ETN-JP/V780-HMD68-ETN-JP-S is a wireless facility conforming to the construction type certification of premises radio station based on the Japanese Radio Act. It cannot be used outside of Japan. Perform the licensing procedures of the premises radio station in order to use the Reader/Writer.

Standards and Regulations

V780-HMD68-ETN-JP/V780-HMD68-ETN-JP-S is a wireless facility conforming to the construction type certification of premises radio station (920-MHz-band Moving Object Differentiation Wireless Facilities) based on the Japanese Radio Act. It cannot be used outside of Japan.

Standards in Japan

Premises Radio Station (920-MHz-band Moving Object Differentiation Wireless Facilities) (ARIB STD-T106 Standard)

Authentication No.: 001-P00881

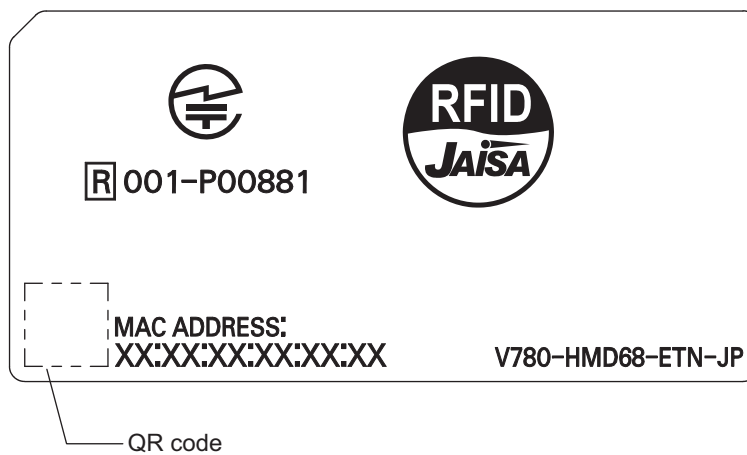

● About Human Exposure

In accordance with Article 21-3 of the Japan Radio Law Enforcement Regulations, this product shall be installed so that no one is allowed to stay at a location within 72cm from the antenna.

* Within 72cm is when the output setting of this product is 27dBm. When the output setting is 21dBm, it is within 36cm, and when it is 15dBm, it is within 18cm.

Licensing Procedures of Premises Radio Station

V780-HMD68-ETN-JP/V780-HMD68-ETN-JP-S is a wireless facility to differentiate moving object using the 920-MHz band. The licensing procedures of the premises radio station must be performed before use. Be sure to perform the licensing procedures before use. The licensing procedures are described in the Appendix.

Refer to *Licensing Procedures of Premises Radio Station* on page A-2.

Manual Structure

Page Structure

The following page structure is used in this manual.

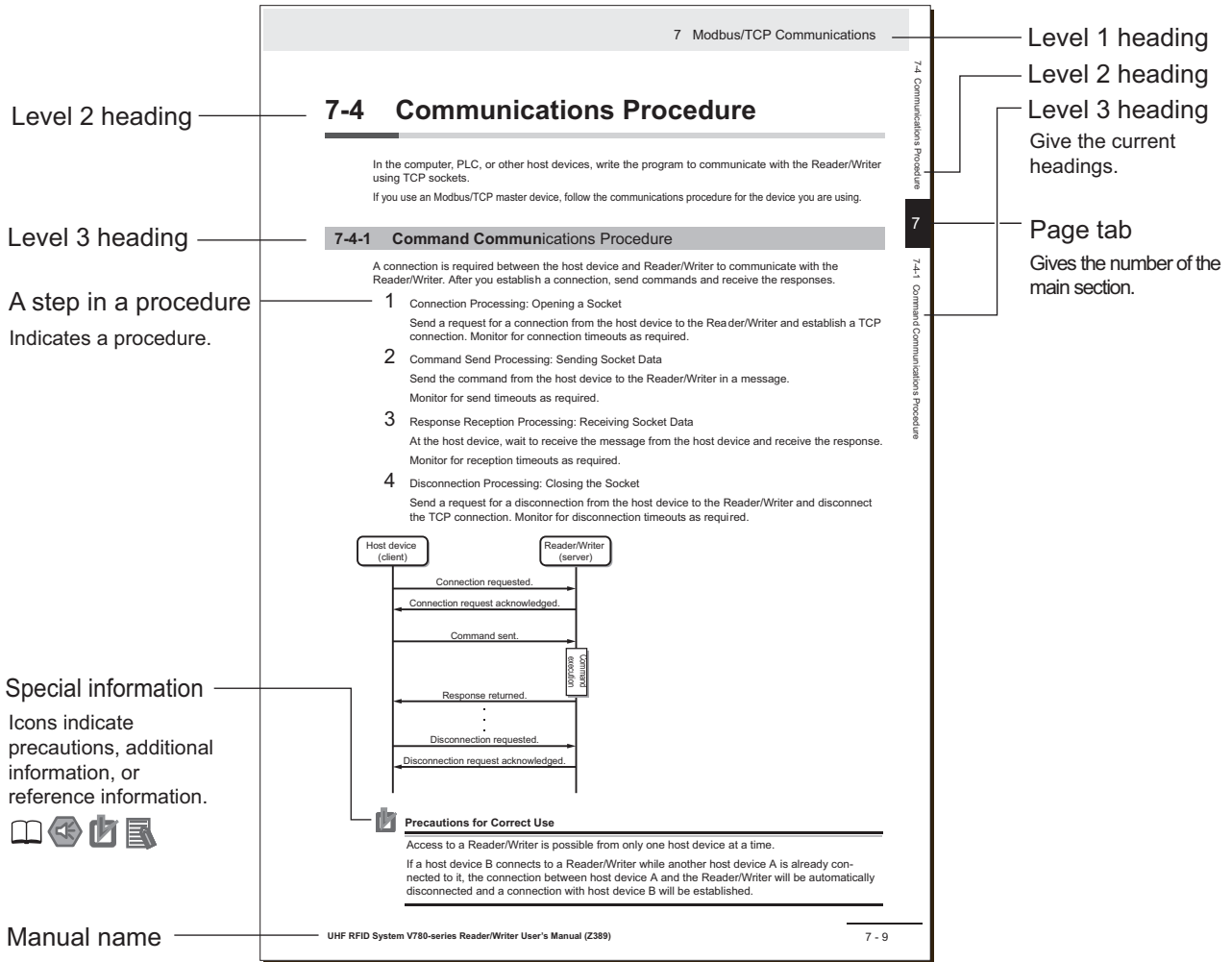

Note This illustration is provided only as a sample. It may not literally appear in this manual.

Special Information

Special information in this manual is classified as follows:



Precautions for Safe Use

Precautions on what to do and what not to do to ensure safe usage of the product.



Precautions for Correct Use

Precautions on what to do and what not to do to prevent malfunction of the product or adverse affects on performances and functions.



Additional Information

Additional information to read as required.

This information is provided to increase understanding or make operation easier.



Version Information

Information about the differences in specifications and functions based on the version of Reader/Writer.

Note References to detailed information or related information.

About the Device Display

Items common to models V780-HMD68-ETN-JP/-KR/-CN/-TW/-IN/-ID/-MY/-SG/-EU/-RU/-US/-MX are written as “V780-HMD68-ETN-□□.”

Items common to models V780-HMD68-ETN-JP-S/-KR-S/-CN-S/-TW-S/-IN-S/-ID-S/-MY-S/-SG-S/-EU-S/-RU-S/-US-S/-MX-S are written as “V780-HMD68-ETN-□□-S”

Sections in this Manual

1	Product Overview	10	Maintenance and Inspection	1	10
2	System Configuration	A	Appendix	2	A
3	Part Names and Functions	I	Index	3	I
4	Installation and Connections			4	
5	Preparations for Communications			5	
6	Functions			6	
7	Modbus/TCP Communications			7	
8	Browser Interface			8	
9	Troubleshooting			9	

CONTENTS

Introduction	1
Terms and Conditions Agreement	2
Safety Precautions	4
Precautions for Safe Use	7
Precautions for Correct Use	8
Standards and Regulations	10
Licensing Procedures of Premises Radio Station	11
Manual Structure	12
Sections in this Manual	15
Revision History	20
Version Upgrade Information	21

Section 1 Product Overview

1-1 Features	1-2
1-2 Application Flowchart	1-5
1-3 Reader/Writer Specifications	1-6
1-3-1 Appearance	1-6
1-3-2 General Specifications	1-6
1-3-3 Tag Communications Specifications	1-8
1-3-4 Recommended Power Supply (24 VDC)	1-14
1-3-5 Dimensions	1-14
1-4 RF Tag Specifications	1-15

Section 2 System Configuration

2-1 RFID System Configuration	2-2
-------------------------------------	-----

Section 3 Part Names and Functions

3-1 Operation Indicators	3-2
3-1-1 Names and Descriptions of Operation Indicators	3-2
3-1-2 Operation Indicators at Startup	3-3
3-1-3 Operation Indicators for WDT Errors	3-4
3-1-4 Operation Indicators for IP Address Conflict	3-5
3-1-5 Operation Indicators When BOOTP Server Connection Fails	3-5
3-1-6 Operation Indicators during Command Execution	3-6
3-1-7 Operation Indicators during Test Execution	3-8
3-1-8 Operation Indicators for System Errors	3-9
3-1-9 During Multi-Reader/Writer function use	3-11
3-2 Connectors	3-13

Section 4 Installation and Connections

4-1	Installation.....	4-2
4-1-1	Reader/Writer	4-2
4-1-2	RF Tags	4-4
4-2	Connections and Wiring	4-6
4-2-1	Connecting and Removing the Reader/Writer Power Cable and Ethernet Cable	4-6

Section 5 Preparations for Communications

5-1	Starting the Reader/Writer	5-2
5-1-1	Procedure to Start the Reader/Writer	5-2
5-2	Setting IP Addresses.....	5-3
5-2-1	Preparations for Work.....	5-3
5-2-2	Setting the IP Address of the Reader/Writer from a Web Browser	5-4

Section 6 Functions

6-1	Operation Modes	6-3
6-1-1	Run Mode	6-3
6-1-2	Safe Mode	6-3
6-2	RF Tag Communications	6-4
6-2-1	Single-access Communications.....	6-4
6-2-2	Multiaccess Communications	6-5
6-2-3	RF Communications Modes	6-6
6-2-4	Communications Commands.....	6-13
6-3	Reader/Writer Controls	6-18
6-3-1	Initialization	6-18
6-3-2	Resetting.....	6-18
6-3-3	Stopping	6-19
6-3-4	RESET FOCUS	6-20
6-3-5	Installation Location Notification	6-21
6-4	Reader/Writer Settings.....	6-22
6-4-1	Network Settings.....	6-22
6-4-2	RF Communications Conditions: Basic Settings	6-24
6-4-3	RF Communications Conditions: Advanced Settings	6-26
6-4-4	Device Settings.....	6-31
6-4-5	Exporting/Important Configuration Files	6-33
6-5	Maintenance: Device Information	6-34
6-5-1	Reading Device Information	6-34
6-5-2	Getting the Operating Status	6-34
6-5-3	Getting and Setting Time Information	6-34
6-6	Maintenance: Log Information	6-35
6-6-1	Getting and Clearing the System Error Log.....	6-35
6-6-2	Getting the Command Error Log.....	6-36
6-6-3	Getting the Most Recent Command Error Information	6-36
6-7	Maintenance: Communications Information.....	6-37
6-7-1	Getting the Reception Level	6-37
6-7-2	Getting the Noise Level	6-37
6-7-3	Communications Diagnostics	6-38
6-8	Tuning.....	6-43
6-8-1	Transmission Power Tuning	6-43
6-9	Utilities.....	6-46
6-9-1	RF Tag Access.....	6-46
6-9-2	RF Tag Scanning	6-47

6-9-3	Reception Level Monitor	6-48
6-9-4	Channel Monitor	6-52
6-9-5	Focus Monitor	6-53
6-10	Multi-Reader/Writer Function	6-56
6-10-1	Outline	6-56
6-10-2	Multi-Reader/Writer Modes	6-57
6-10-3	Application	6-62
6-10-4	Communications conditions during Multi-Reader/Writer use	6-69
6-10-5	Maintenance functions during Multi-Reader/Writer use	6-70

Section 7 Modbus/TCP Communications

7-1	Outline	7-2
7-1-1	Modbus/TCP Communications	7-2
7-1-2	Modbus/TCP Function Codes Supported by the V780	7-3
7-1-3	Communications System	7-3
7-2	Message Formats	7-5
7-2-1	Command Format	7-5
7-2-2	Response Format for Normal Completion	7-6
7-2-3	Response Format for Error Completion	7-7
7-2-4	Read Multiple Registers Command/Response (FC03)	7-8
7-2-5	Write Multiple Registers Command/Response (FC16)	7-8
7-2-6	Expanded Command/Response (FC100)	7-9
7-3	RF Communications Command Options	7-10
7-4	Communications Procedure	7-12
7-4-1	Command Communications Procedure	7-12
7-4-2	Error Response Reception Procedure	7-13
7-4-3	RF Tag Communications Command Procedure for Single-access Communications	7-14
7-4-4	RF Tag Communications Command Procedure for Multiaccess Communications	7-16
7-5	Commands	7-19
7-6	V780 Command Details	7-22
7-6-1	Single-access Communications Commands	7-22
7-6-2	Multiaccess Communications Commands	7-34
7-6-3	Modbus Expansion Communications Commands	7-44
7-6-4	Reader/Writer Control Commands	7-52
7-6-5	Reader/Writer Setting Commands: Network Settings	7-57
7-6-6	Reader/Writer Setting Commands: Communications Settings	7-73
7-6-7	Reader/Writer Setting Commands: Device Settings	7-103
7-6-8	Maintenance Commands: Device Information	7-111
7-6-9	Maintenance Commands: Log Information	7-124
7-6-10	Maintenance Commands: RF Communications Information	7-131

Section 8 Browser Interface

8-1	Browser Operation Interface	8-2
8-2	Operation Interface	8-4
8-2-1	Password Entry View	8-4
8-2-2	Status	8-5
8-2-3	Network Settings	8-6
8-2-4	RF Communications Settings	8-9
8-2-5	Device Settings	8-13
8-2-6	Tuning	8-15
8-2-7	Utilities	8-17
8-2-8	Logs	8-26
8-2-9	Rebooting	8-32
8-2-10	Configuration	8-33
8-2-11	Configuration File	8-39

Section 9 Troubleshooting

9-1	Types of Errors	9-2
9-1-1	Errors Indicated on Operation Indicators	9-2
9-1-2	Errors Indicated with Error Codes.....	9-3
9-2	Error Tables.....	9-4
9-2-1	Command Errors	9-4
9-2-2	System Errors	9-6
9-2-3	WDT Errors.....	9-7
9-3	Errors and Countermeasures	9-8
9-3-1	Command Errors	9-8
9-3-2	RF Tag Communications Error	9-11
9-3-3	Minor Fault.....	9-15
9-3-4	Major Fault.....	9-18
9-3-5	WDT Error.....	9-18
9-4	How to deal with browser interface problems	9-19
9-4-1	When the Web browser screen is not displayed or the screen layout is strange	9-19

Section 10 Maintenance and Inspection

10-1	Maintenance and Inspection	10-2
-------------	---	-------------

Section A Appendices

A-1	Licensing Procedures of Premises Radio Station	A-2
A-2	RF Tag Communications Times (For reference only)	A-4
A-3	RF Tag Memory Map.....	A-17
A-4	Communications Range Diagram, Reception Level Diagram (Reference Only)	A-18
A-5	Mutual Interference of Reader/Writers (Reference Only).....	A-25
A-6	Chemical Resistance of the Reader/Writers	A-29
A-7	For customers using Reader/Writer earlier than firmware Ver.4.00.....	A-30
A-7-1	Operating environment when using a web browser.....	A-30
A-7-2	Cannot Display the Web Browser Operation Window	A-31

Index

Revision History

A manual revision code appears as a suffix to the catalog number on the front and back covers of the manual.

Cat. No.	Z389-E1-12
-----------------	-------------------

↑
Revision code

Revision code	Date	Revised contents
01	March 2017	Original production
02	October 2017	Multi-Reader/Writer function added Content regarding models for various countries added (V780-HMD68-ETN-KR/-IN/-SG/-EU/-US/-MX)
03	November 2017	Content regarding models for various countries added (V780-HMD68-ETN-TW/-ID/-MY)
04	December 2017	Content regarding models for various countries added (V780-HMD68-ETN-RU) Corrected information about RF communications timeout time.
05	January 2018	Content regarding models for various countries added (V780-HMD68-ETN-CN)
06	October 2018	Corrected content regarding Data retention and Write life in RF Tag Specification. and made other minor corrections
07	July 2019	Changed the description of Java version.
08	September 2019	Added the description of V780-HMD68-ETN-□□-S Change communications time at multi access Added description about transmission power tuning to "9-3-2 RF Tag Communications Error"
09	December 2019	Added a workaround to "9-4 Cannot Display the Web Browser Operation Window on page 9-19" and made other minor corrections
10	November 2021	Change of recommended operating environment of Web browser Changes in the appearance and layout of the Web browser interface Added information of Java version earlier than firmware Ver.4.00.
11	June 2022	Added information of Windows 11.
12	September 2022	Added information about Security Measures to Safety Precautions.

Version Upgrade Information

This section describes the version upgrade details of firmware.

Ver 1.00 → Ver 2.00

Change content	Page
Added "Auto" and "Focus" for the RF communications mode.	P. 6-6
Expanded the access range of the user area in the RF tag with the communications command. 0000 to 07FF hex (2,048 words) → 0000 to 0FFF hex (4,096 words)	P. 6-13
Added "RESET FOCUS" for the Reader/Writer control function.	P. 6-20
Added "Installation Location Notification" for the Reader/Writer control function.	P. 6-21
Added "RF Tag Selection Filter" for the RF communications conditions settings (advanced).	P. 6-30
Added "RSSI Filter" for the RF communications conditions settings (advanced).	P. 6-29
Added "Transmission Time" for the RF communications conditions settings (advanced).	P. 6-28
Added "Operation Indicator Custom Settings" for the device settings.	P. 6-31
Added "Communications Diagnostics" for the maintenance function (communications information).	P. 6-38
Added "Transmission Power Tuning" for the tuning function.	P. 6-43
Added "RF Tag Access" for the utility function.	P. 6-46
Added "RF Tag Scanning" for the utility function.	P. 6-47
Added "Reception Level Monitor" for the utility function.	P. 6-48
Added "Channel Monitor" for the utility function.	P. 6-52
Added "Focus Monitor" for the utility function.	P. 6-53

Ver 2.00 → Ver 3.00

Change content	Page
Added the Multi-Reader/Writer function.	P. 6-6
Changed the channel to a channel number in accordance with the regulations of the Japanese Radio Act, in the RF communications settings (advanced).	P. 6-13
Changed the display during the noise level peak in "Channel Monitor" of the utility function.	P. 6-20

Ver 3.00 → Ver 3.01

Change content	Page
The communications time at multi access of "A-2 RF Tag Communications Times (For reference only)"	P. A-4

Ver 3.01 → Ver 4.00

Change content	Page
Changed the layout of the web browser interface.	P. 8-2
"Repeat count" has been added to the Tuning function.	P. 8-15
Added the function to select whether to Enable/Disable the RSSI filter during testing with the Utility function "Reception level monitor".	P. 8-20
Changed to display 8,192 items in one page in the graph display of "RF communications diagnostics log" of the Log view function.	P. 8-30



Product Overview

This section describes the features, overall operation flow, and product specifications of the V780 Reader/Writer.

1-1	Features	1-2
1-2	Application Flowchart	1-5
1-3	Reader/Writer Specifications	1-6
1-3-1	Appearance	1-6
1-3-2	General Specifications	1-6
1-3-3	Tag Communications Specifications	1-8
1-3-4	Recommended Power Supply (24 VDC)	1-14
1-3-5	Dimensions	1-14
1-4	RF Tag Specifications	1-15

1-1 Features

The integrated V780-series Reader/Writer (V780-HMD68-ETN-□□) performs communications with RF Tags according to commands from a host device.

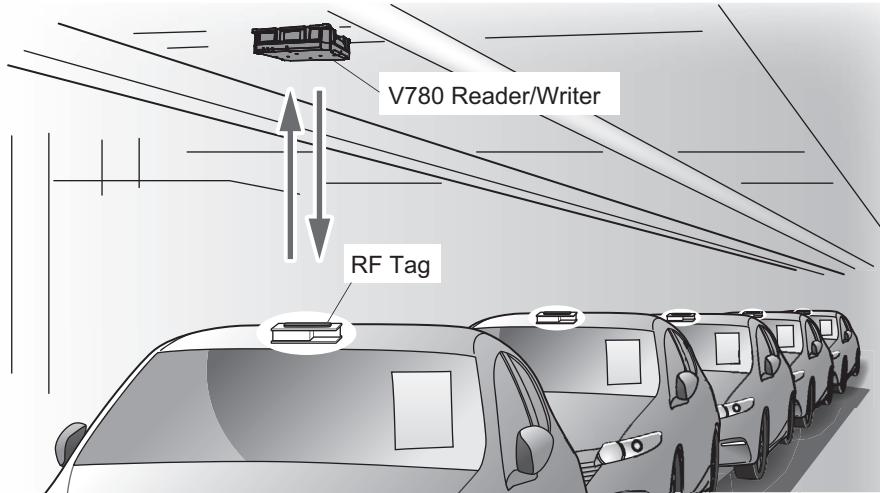

Integrated Structure

The controller, amplifier, and antenna are integrated into the Reader/Writer for a simple structure.

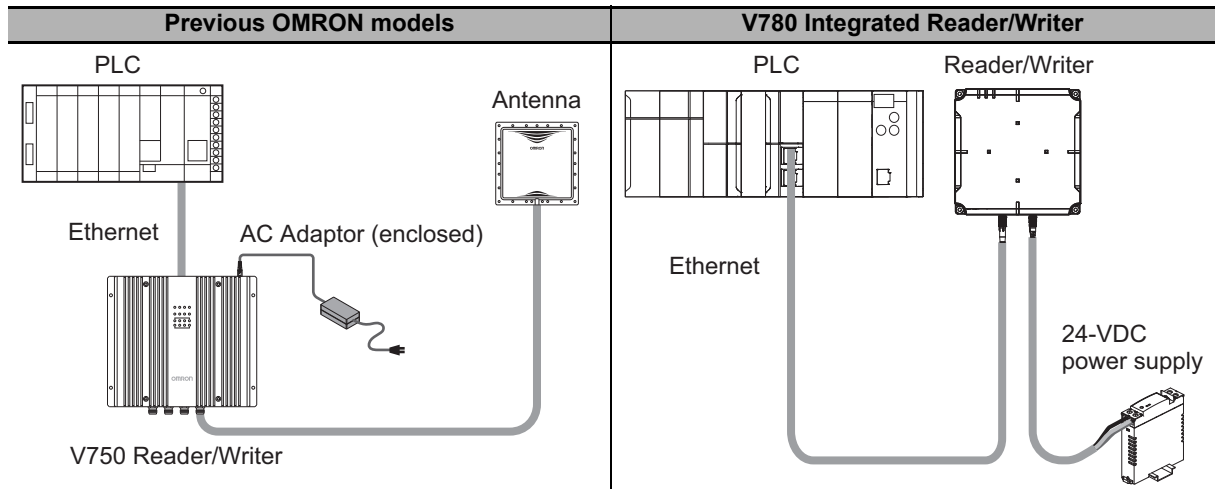

Simple Connection with Ethernet

The highly generic Ethernet is used to connect to the host device to enable easy connection with Ethernet cable without any restrictions from the host PLC manufacturer. You can also use a switching hub to easily expand a system for connection of many Reader/Writers.

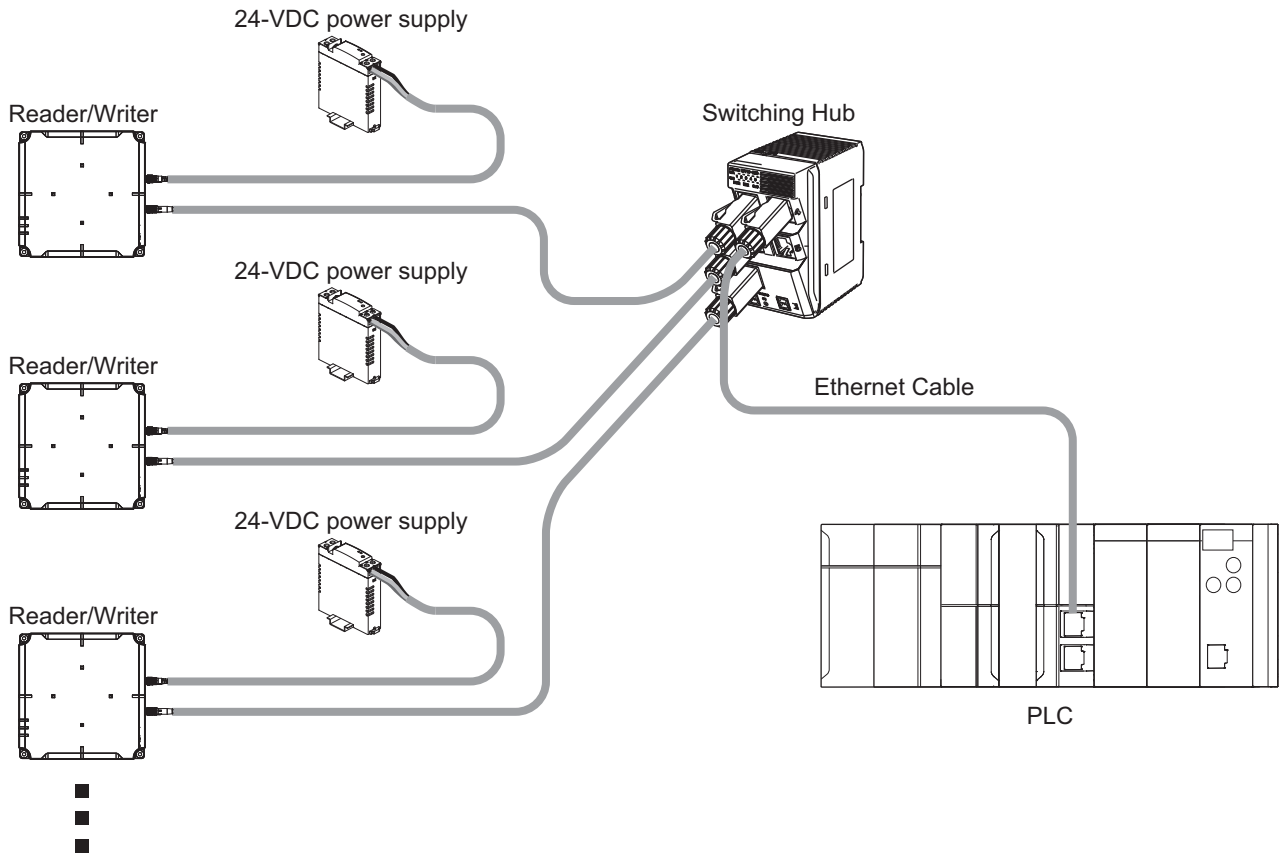

Precautions for Correct Use

To connect more than one Reader/Writer, all devices must be set to a unique IP address.

Easy Operation with a Browser Interface

A Web browser interface is built in, so you do not need special software.

Just connect the computer to the Reader/Writer from your browser to easily communicate with RF Tags, make Reader/Writer settings, and monitor status.

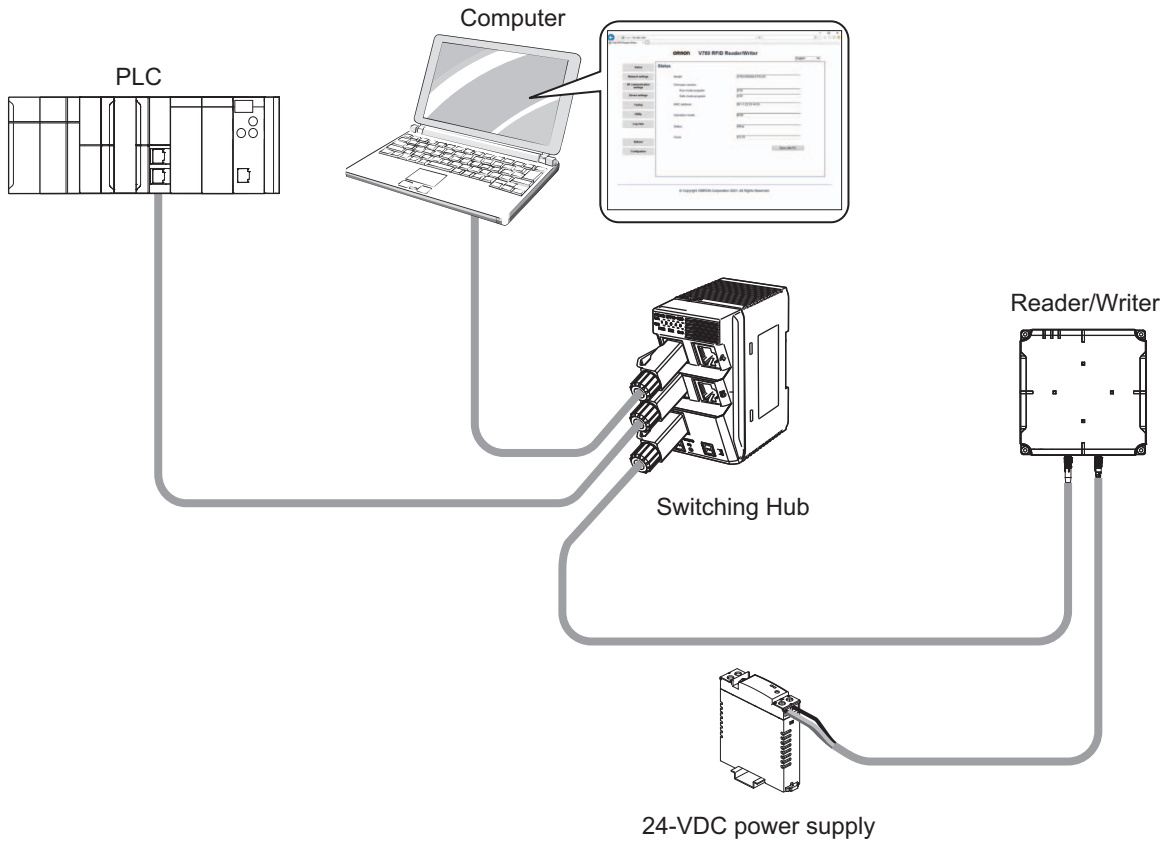

1-2 Application Flowchart

A simple application flowchart is provided below. For correct application methods and details, refer to the reference page or section given for each step.

Also, use the *Startup Guide* provided with the Reader/Writer to help you start operation.

When using the slave reader/writer, the procedure is slightly different. For details, see the startup guide for slave reader/writer.

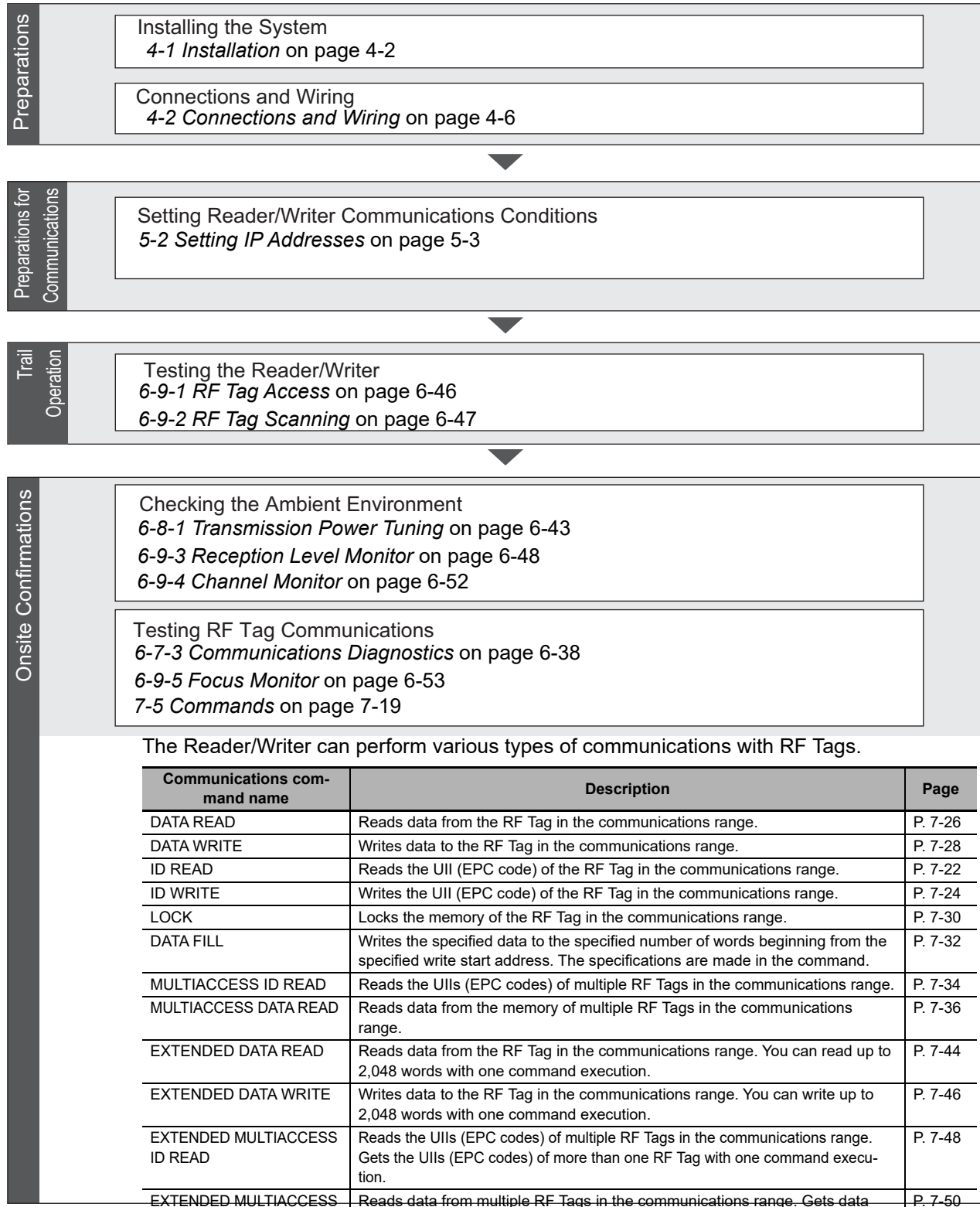

1-3 Reader/Writer Specifications

1-3-1 Appearance

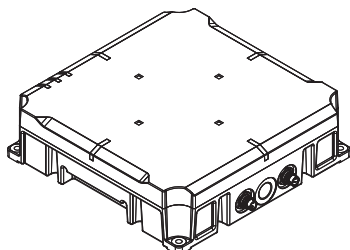

1-3-2 General Specifications

Item	V780-HMD68-ETN-□□	V780-HMD68-ETN-□□-S
Dimensions	250 × 250 × 70 mm (W × H × D, excluding protruding parts and cables)	
Supply voltage	24 VDC (−15% to +10%)	
Power consumption	10 W max.	
Ambient operating temperature	−10 to 55°C (with no icing)	
Ambient operating humidity	25% to 85% (with no condensation)	
Ambient storage temperature	−25 to 70°C (with no icing)	
Ambient storage humidity	25% to 85% (with no condensation)	
Insulation resistance	20 MΩ min. (at 500 VDC) between cable terminals and case	
Dielectric strength	1,000 VAC, 50/60 Hz for 1 min between cable terminals and case	
Vibration resistance	No abnormality after application of 10 to 500 Hz, double amplitude: 1.5 mm, acceleration: 100 m/s ² , 10 sweeps in each of 3 axis directions (up/down, left/right, and forward/backward) for 11 minutes each	
Shock resistance	No abnormality after application of 500 m/s ² , 3 times each in 6 directions (Total: 18 times)	
Degree of protection	IP54 (IEC 60529:2001)	
Materials	Plastic case: PBT Metal case: Die-cast aluminum (ADC12)	
Weight	Approx. 3 kg	
Mounting method	Four M6 bolts	
Host communications interface	Ethernet 10BASE-T/100BASE-TX	
Host communications protocol	Modbus/TCP base	Multi-Reader/Writer Function only*1
Accessories	Instruction Sheet (1), IP address label (1), Startup Guide (1), Ferrite core (2)*2, and EU DECLARATION OF CONFORMITY (1)*3	
Regulations	See <i>Regulations</i> on page 1-7 for the regulations.	

*1. 1. Communication is performed only via the master reader/writer (model V780-HMD68-ETN-□□). It can not be controlled from a host device such as PLC. But web server function is available.

*2. A ferrite core is packaged with Model V780-HMD68-ETN-IN/-EU/-RU/-IN-S/-EU-S/-RU-S.

*3. A EU DECLARATION OF CONFORMITY is packaged with Model V780-HMD68-ETN-EU/-EU-S.

Regulations

Model	Regulations
V780-HMD68-ETN-JP V780-HMD68-ETN-JP-S	Premises Radio Station (920-MHz-band Moving Object Differentiation Wireless Facilities), ARIB STD-T106
V780-HMD68-ETN-KR V780-HMD68-ETN-KR-S	무선설비규칙
V780-HMD68-ETN-CN V780-HMD68-ETN-CN-S	Ministry of Information Industry No. 205 (2007)
V780-HMD68-ETN-TW V780-HMD68-ETN-TW-S	NCC LP0002 4.8 RFID
V780-HMD68-ETN-IN V780-HMD68-ETN-IN-S	the G.S.R.36 (E)
V780-HMD68-ETN-ID V780-HMD68-ETN-ID-S	PERDIRJEN POSTEL Nomor: 221/DIRJEN/2007
V780-HMD68-ETN-MY V780-HMD68-ETN-MY-S	MCMC MTSFB TC T007:2014
V780-HMD68-ETN-SG V780-HMD68-ETN-SG-S	Singapore : IMDA TS SRD2 Thailand : NTC TS 1010-2550 (RFID 920-925 MHz)
V780-HMD68-ETN-EU V780-HMD68-ETN-EU-S	2014/53EU (RE Directive)
V780-HMD68-ETN-RU V780-HMD68-ETN-RU-S	к решению ГКПЧ от 07.05.2007 № 07-20-03-001
V780-HMD68-ETN-US V780-HMD68-ETN-US-S	FCC 15.247 (United states) ISED RSS-247 (Canada)
V780-HMD68-ETN-MX V780-HMD68-ETN-MX-S	IFT-008 NYCE NOM-208

1-3-3 Tag Communications Specifications

V780-HMD68-ETN-JP/V780-HMD68-ETN-JP-S

	Item	V780-HMD68-ETN-JP/V780-HMD68-ETN-JP-S
Tag Communications Specifications	Applicable countries	Japan
	Maximum Radiated power	4 W e.i.r.p
	Output power	15 to 27 dBm (Switchable in 1-dB increments.)
	RSSI detection range	Signal level: -35 to -61 dBm Noise level: -35 to -70 dBm (at end of antenna cable)
	Transmission speed from Reader/Writer to RF Tag	40 kbps (fixed)
	Transmission speed from RF Tag to Reader/Writer	<ul style="list-style-type: none"> • 80 kbps (High-speed Mode)^{*1} • 20 kbps (Standard Mode)^{*1}
	Used frequencies (Described at the center frequency of each channel)	3 channels (916.8/918.0/919.2 MHz) License
	Channel interval	200 kHz
	Communications method with RF Tags	Miller-modulated subcarrier
	Tag communications protocol	ISO/IEC 18000-63: 2013 (EPCglobal Class-1 Generation-2)
	Polarization characteristic	RHCP
	Multiaccess communications	Up to 64 RF Tags can be read.

*1. The default setting is for Automatic Mode. The Reader/Writer will automatically change to High-speed Mode or Standard Mode depending on the interference waves.

V780-HMD68-ETN-KR/V780-HMD68-ETN-KR-S

	Item	V780-HMD68-ETN-KR/V780-HMD68-ETN-KR-S
Tag Communications Specifications	Applicable countries	Korea
	Maximum Radiated power	4 W e.i.r.p
	Output power	15 to 27 dBm (Switchable in 1-dB increments.)
	RSSI detection range	Signal level: -35 to -61 dBm Noise level: -35 to -70 dBm (at end of antenna cable)
	Transmission speed from Reader/Writer to RF Tag	40 kbps (fixed)
	Transmission speed from RF Tag to Reader/Writer	<ul style="list-style-type: none"> • 80 kbps (High-speed Mode)^{*1} • 31.25 kbps (Standard Mode)^{*1}
	Used frequencies	6 channels (917.3/917.9/918.5/919.1/919.7/920.3 MHz) FHSS
	Channel interval	200 kHz
	Communications method with RF Tags	Miller-modulated subcarrier
	Tag communications protocol	ISO/IEC 18000-63: 2013 (EPCglobal Class-1 Generation-2)
	Polarization characteristic	RHCP
	Multiaccess communications	Up to 64 RF Tags can be read.

*1. The default setting is for Automatic Mode. The Reader/Writer will automatically change to High-speed Mode or Standard Mode depending on the interference waves.

V780-HMD68-ETN-CN/V780-HMD68-ETN-CN-S

	Item	V780-HMD68-ETN-CN/V780-HMD68-ETN-CN-S
Tag Communications Specifications	Applicable countries	China
	Maximum Radiated power	2 W e.r.p
	Output power	15 to 27 dBm (Switchable in 1-dB increments.)
	RSSI detection range	Signal level: -35 to -61 dBm Noise level: -35 to -70 dBm (at end of antenna cable)
	Transmission speed from Reader/Writer to RF Tag	40 kbps (fixed)
	Transmission speed from RF Tag to Reader/Writer	<ul style="list-style-type: none"> • 80 kbps (High-speed Mode)^{*1} • 20 kbps (Standard Mode)^{*1}
	Used frequencies	16 channels (920.625 to 924.375 MHz) FHSS
	Channel interval	250 kHz
	Communications method with RF Tags	Miller-modulated subcarrier
	Tag communications protocol	ISO/IEC 18000-63: 2013 (EPCglobal Class-1 Generation-2)
	Polarization characteristic	RHCP
	Multiaccess communications	Up to 64 RF Tags can be read.

*1. The default setting is for Automatic Mode. The Reader/Writer will automatically change to High-speed Mode or Standard Mode depending on the interference waves.

V780-HMD68-ETN-TW/V780-HMD68-ETN-TW-S

	Item	V780-HMD68-ETN-TW/V780-HMD68-ETN-TW-S
Tag Communications Specifications	Applicable countries	Taiwan
	Maximum Radiated power	4 W e.i.r.p (Indoor use only)
	Output power	15 to 27 dBm (Switchable in 1-dB increments.)
	RSSI detection range	Signal level: -35 to -61 dBm Noise level: -35 to -70 dBm (at end of antenna cable)
	Transmission speed from Reader/Writer to RF Tag	40 kbps (fixed)
	Transmission speed from RF Tag to Reader/Writer	<ul style="list-style-type: none"> • 80 kbps (High-speed Mode)^{*1} • 31.25 kbps (Standard Mode)^{*1}
	Used frequencies	10 channels (922.75 to 927.25 MHz) FHSS
	Channel interval	500 kHz
	Communications method with RF Tags	Miller-modulated subcarrier
	Tag communications protocol	ISO/IEC 18000-63: 2013 (EPCglobal Class-1 Generation-2)
	Polarization characteristic	RHCP
	Multiaccess communications	Up to 64 RF Tags can be read.

*1. The default setting is for Automatic Mode. The Reader/Writer will automatically change to High-speed Mode or Standard Mode depending on the interference waves.

V780-HMD68-ETN-IN/V780-HMD68-ETN-IN-S

	Item	V780-HMD68-ETN-IN/V780-HMD68-ETN-IN-S
Tag Communications Specifications	Applicable countries	India
	Maximum Radiated power	2 W e.r.p
	Output power	15 to 27 dBm (Switchable in 1-dB increments.)
	RSSI detection range	Signal level: -35 to -61 dBm Noise level: -35 to -70 dBm (at end of antenna cable)
	Transmission speed from Reader/Writer to RF Tag	40 kbps (fixed)
	Transmission speed from RF Tag to Reader/Writer	<ul style="list-style-type: none"> • 80 kbps (High-speed Mode)^{*1} • 31.25 kbps (Standard Mode)^{*1}
	Used frequencies	3 channels (865.7/866.3/866.9 MHz) FHSS
	Channel interval	200 kHz
	Communications method with RF Tags	Miller-modulated subcarrier
	Tag communications protocol	ISO/IEC 18000-63: 2013 (EPCglobal Class-1 Generation-2)
	Polarization characteristic	RHCP
Multiaccess communications	Up to 64 RF Tags can be read.	

*1. The default setting is for Automatic Mode. The Reader/Writer will automatically change to High-speed Mode or Standard Mode depending on the interference waves.

V780-HMD68-ETN-ID/V780-HMD68-ETN-ID-S

	Item	V780-HMD68-ETN-ID/V780-HMD68-ETN-ID-S
Tag Communications Specifications	Applicable countries	Indonesia
	Maximum Radiated power	2 W e.r.p
	Output power	15 to 27 dBm (Switchable in 1-dB increments.)
	RSSI detection range	Signal level: -35 to -61 dBm Noise level: -35 to -70 dBm (at end of antenna cable)
	Transmission speed from Reader/Writer to RF Tag	40 kbps (fixed)
	Transmission speed from RF Tag to Reader/Writer	<ul style="list-style-type: none"> • 80 kbps (High-speed Mode)^{*1} • 31.25 kbps (Standard Mode)^{*1}
	Used frequencies	4 channels (923.25/923.75/924.25/924.75 MHz) FHSS
	Channel interval	500 kHz
	Communications method with RF Tags	Miller-modulated subcarrier
	Tag communications protocol	ISO/IEC 18000-63: 2013 (EPCglobal Class-1 Generation-2)
	Polarization characteristic	RHCP
Multiaccess communications	Up to 64 RF Tags can be read.	

*1. The default setting is for Automatic Mode. The Reader/Writer will automatically change to High-speed Mode or Standard Mode depending on the interference waves.

V780-HMD68-ETN-MY/V780-HMD68-ETN-MY-S

	Item	V780-HMD68-ETN-MY/V780-HMD68-ETN-MY-S
Tag Communications Specifications	Applicable countries	Malaysia
	Maximum Radiated power	2 W e.r.p
	Output power	15 to 27 dBm (Switchable in 1-dB increments.)
	RSSI detection range	Signal level: -35 to -61 dBm Noise level: -35 to -70 dBm (at end of antenna cable)
	Transmission speed from Reader/Writer to RF Tag	40 kbps (fixed)
	Transmission speed from RF Tag to Reader/Writer	<ul style="list-style-type: none"> • 80 kbps (High-speed Mode)^{*1} • 31.25 kbps (Standard Mode)^{*1}
	Used frequencies	8 channels (919.25 to 922.75 MHz) FHSS
	Channel interval	500 kHz
	Communications method with RF Tags	Miller-modulated subcarrier
	Tag communications protocol	ISO/IEC 18000-63: 2013 (EPCglobal Class-1 Generation-2)
	Polarization characteristic	RHCP
	Multiaccess communications	Up to 64 RF Tags can be read.

*1. The default setting is for Automatic Mode. The Reader/Writer will automatically change to High-speed Mode or Standard Mode depending on the interference waves.

V780-HMD68-ETN-SG/V780-HMD68-ETN-SG-S

	Item	V780-HMD68-ETN-SG/V780-HMD68-ETN-SG-S
Tag Communications Specifications	Applicable countries	Singapore and Thailand
	Maximum Radiated power	2 W e.r.p
	Output power	15 to 27 dBm (Switchable in 1-dB increments.)
	RSSI detection range	Signal level: -35 to -61 dBm Noise level: -35 to -70 dBm (at end of antenna cable)
	Transmission speed from Reader/Writer to RF Tag	40 kbps (fixed)
	Transmission speed from RF Tag to Reader/Writer	<ul style="list-style-type: none"> • 80 kbps (High-speed Mode)^{*1} • 31.25 kbps (Standard Mode)^{*1}
	Used frequencies	8 channels (920.75 to 924.25 MHz) FHSS
	Channel interval	500 kHz
	Communications method with RF Tags	Miller-modulated subcarrier
	Tag communications protocol	ISO/IEC 18000-63: 2013 (EPCglobal Class-1 Generation-2)
	Polarization characteristic	RHCP
	Multiaccess communications	Up to 64 RF Tags can be read.

*1. The default setting is for Automatic Mode. The Reader/Writer will automatically change to High-speed Mode or Standard Mode depending on the interference waves.

V780-HMD68-ETN-EU/V780-HMD68-ETN-EU-S

	Item	V780-HMD68-ETN-EU/V780-HMD68-ETN-EU-S
Tag Communications Specifications	Applicable countries	Under RE direct
	Maximum Radiated power	2 W e.r.p
	Output power	15 to 27 dBm (Switchable in 1-dB increments.)
	RSSI detection range	Signal level: -35 to -61 dBm Noise level: -35 to -70 dBm (at end of antenna cable)
	Transmission speed from Reader/Writer to RF Tag	40 kbps (fixed)
	Transmission speed from RF Tag to Reader/Writer	<ul style="list-style-type: none"> • 80 kbps (High-speed Mode)^{*1} • 31.25 kbps (Standard Mode)^{*1}
	Used frequencies	4 channels (865.7/866.3/866.9/867.5 MHz) FHSS
	Channel interval	200 kHz
	Communications method with RF Tags	Miller-modulated subcarrier
	Tag communications protocol	ISO/IEC 18000-63: 2013 (EPCglobal Class-1 Generation-2)
	Polarization characteristic	RHCP
Multiaccess communications	Up to 64 RF Tags can be read.	

*1. The default setting is for Automatic Mode. The Reader/Writer will automatically change to High-speed Mode or Standard Mode depending on the interference waves.

V780-HMD68-ETN-RU/V780-HMD68-ETN-RU-S

	Item	V780-HMD68-ETN-RU/V780-HMD68-ETN-RU-S
Tag Communications Specifications	Applicable countries	Russia
	Maximum Radiated power	2 W e.r.p
	Output power	15 to 27 dBm (Switchable in 1-dB increments.)
	RSSI detection range	Signal level: -35 to -61 dBm Noise level: -35 to -70 dBm (at end of antenna cable)
	Transmission speed from Reader/Writer to RF Tag	40 kbps (fixed)
	Transmission speed from RF Tag to Reader/Writer	<ul style="list-style-type: none"> • 80 kbps (High-speed Mode)^{*1} • 31.25 kbps (Standard Mode)^{*1}
	Used frequencies	3 channels (866.3/866.9/867.5 MHz) FHSS
	Channel interval	200 kHz
	Communications method with RF Tags	Miller-modulated subcarrier
	Tag communications protocol	ISO/IEC 18000-63: 2013 (EPCglobal Class-1 Generation-2)
	Polarization characteristic	RHCP
Multiaccess communications	Up to 64 RF Tags can be read.	

*1. The default setting is for Automatic Mode. The Reader/Writer will automatically change to High-speed Mode or Standard Mode depending on the interference waves.

V780-HMD68-ETN-US/V780-HMD68-ETN-US-S

	Item	V780-HMD68-ETN-US/V780-HMD68-ETN-US-S
Tag Communications Specifications	Applicable countries	United States and Canada
	Maximum Radiated power	4 W e.i.r.p
	Output power	15 to 27 dBm (Switchable in 1-dB increments.)
	RSSI detection range	Signal level: -35 to -61 dBm Noise level: -35 to -70 dBm (at end of antenna cable)
	Transmission speed from Reader/Writer to RF Tag	40 kbps (fixed)
	Transmission speed from RF Tag to Reader/Writer	<ul style="list-style-type: none"> • 80 kbps (High-speed Mode)^{*1} • 31.25 kbps (Standard Mode)^{*1}
	Used frequencies	50 channels (902.75 to 927.25 MHz) FHSS
	Channel interval	500 kHz
	Communications method with RF Tags	Miller-modulated subcarrier
	Tag communications protocol	ISO/IEC 18000-63: 2013 (EPCglobal Class-1 Generation-2)
	Polarization characteristic	RHCP
	Multiaccess communications	Up to 64 RF Tags can be read.

*1. The default setting is for Automatic Mode. The Reader/Writer will automatically change to High-speed Mode or Standard Mode depending on the interference waves.

V780-HMD68-ETN-MX/V780-HMD68-ETN-MX-S

	Item	V780-HMD68-ETN-MX/V780-HMD68-ETN-MX-S
Tag Communications Specifications	Applicable countries	Mexico
	Maximum Radiated power	4 W e.i.r.p
	Output power	15 to 27 dBm (Switchable in 1-dB increments.)
	RSSI detection range	Signal level: -35 to -61 dBm Noise level: -35 to -70 dBm (at end of antenna cable)
	Transmission speed from Reader/Writer to RF Tag	40 kbps (fixed)
	Transmission speed from RF Tag to Reader/Writer	<ul style="list-style-type: none"> • 80 kbps (High-speed Mode)^{*1} • 31.25 kbps (Standard Mode)^{*1}
	Used frequencies	50 channels (902.75 to 927.25 MHz) FHSS
	Channel interval	500 kHz
	Communications method with RF Tags	Miller-modulated subcarrier
	Tag communications protocol	ISO/IEC 18000-63: 2013 (EPCglobal Class-1 Generation-2)
	Polarization characteristic	RHCP
	Multiaccess communications	Up to 64 RF Tags can be read.

*1. The default setting is for Automatic Mode. The Reader/Writer will automatically change to High-speed Mode or Standard Mode depending on the interference waves.

1-3-4 Recommended Power Supply (24 VDC)

Item	Condition
Supply voltage	24 VDC -15% to +10%
Output current	500 mA min.
Safety standard	SELV (Safety Extra Low Voltage)

1-3-5 Dimensions

(Unit: mm)

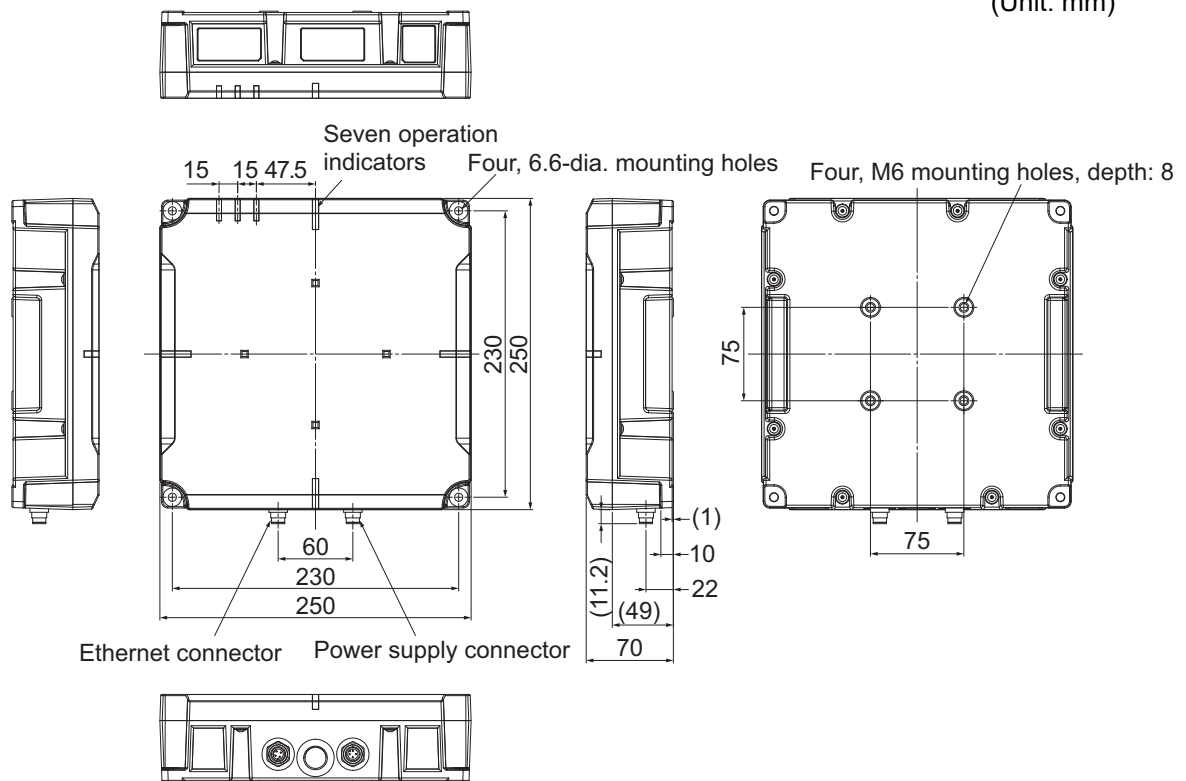

1-4 RF Tag Specifications

V780-A-JIME-Z3BLI-10*¹ RF Tags (Recommended)

- Appearance

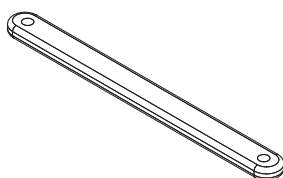

- OMRON Model Number: V780-A-JIME-Z3BLI-10*¹

- General Specifications

Item	V780-A-JIME-Z3BLI-10* ¹ (made by Toppan Forms Co., Ltd.)
Dimensions	150 × 14 × 6 mm (W × H × D)
IC chip, memory	Monza X 8K UII (EPC): 128 bits User memory: 8,192 bits
Write life / Data retention	10,000 writes / 10 years 100,000 writes / 1 year
Operating temperature	-20 to 65°C
Operating humidity	5% to 95%
Storage temperature	-30 to 70°C
Storage humidity	5% to 95%
Material	Polycarbonate plastic
Weight	Tag: Approx. 15 g
Degree of protection	IP68 (IEC 60529: 2001)



Precautions for Correct Use

The marked surface is the communications surface. When mounting an RF Tag, face the marked surface toward the Reader/Writer.

- Dimensions

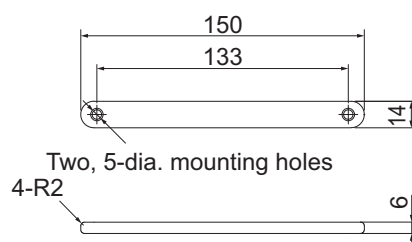

(Unit: mm)

*1. This is the model number for one package of 10 RF Tags.
Order the number of packages that you require.

V780-A-TA-133-10*¹ Attachment (Recommended)

- Appearance

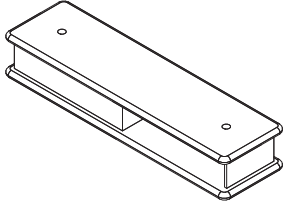

- OMRON Model Number: V780-A-TA-133-10*¹

- General Specifications

Item	V780-A-TA-133-10* ¹ (made by Toppan Forms Co., Ltd.)
Dimensions	180 × 50 × 30 mm (W × H × D)
Operating temperature	-20 to 65°C
Operating humidity	5% to 95%
Storage temperature	-30 to 70°C
Storage humidity	5% to 95%
Material	Polycarbonate plastic
Weight	Approx. 128 g

- Dimensions

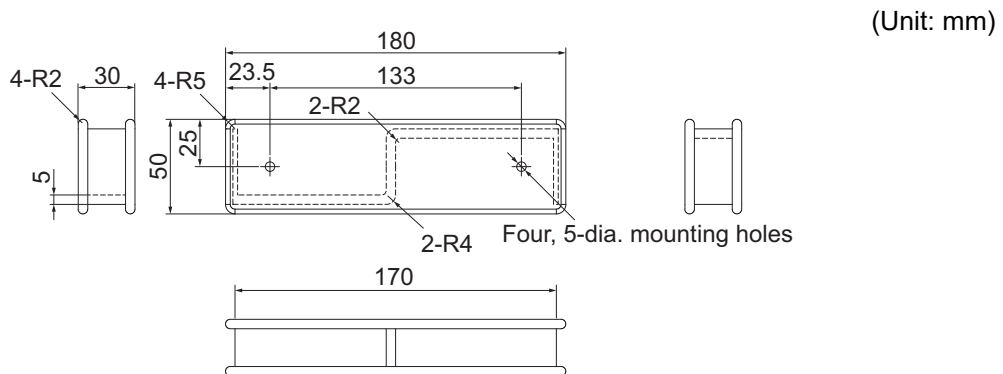

*1. This is the model number for one package of 10 RF Tags.
Order the number of packages that you require.



System Configuration

This section describes the system configuration that you can use for a V780 Reader/Writer.

2-1 RFID System Configuration 2-2

2-1 RFID System Configuration

The following four variations are possible in the RFID system configuration.

- Host device (e.g., PLC) with one Reader/Writer
- Host device (e.g., PLC) with multiple Reader/Writers
- Host device and a computer
- Connection to a workpiece detection sensor

Host Device (e.g., PLC) with One Reader/Writer

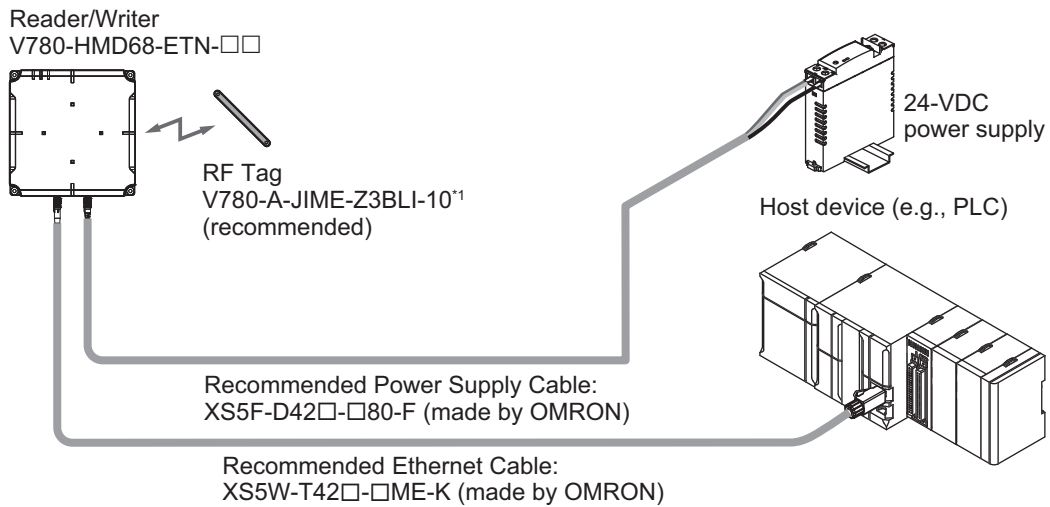

*1. This is the model number for one package of 10 RF Tags.
Order the number of packages that you require.

Host Device (e.g., PLC) with Multiple Reader/Writers

● When the multi reader/writer function is not used

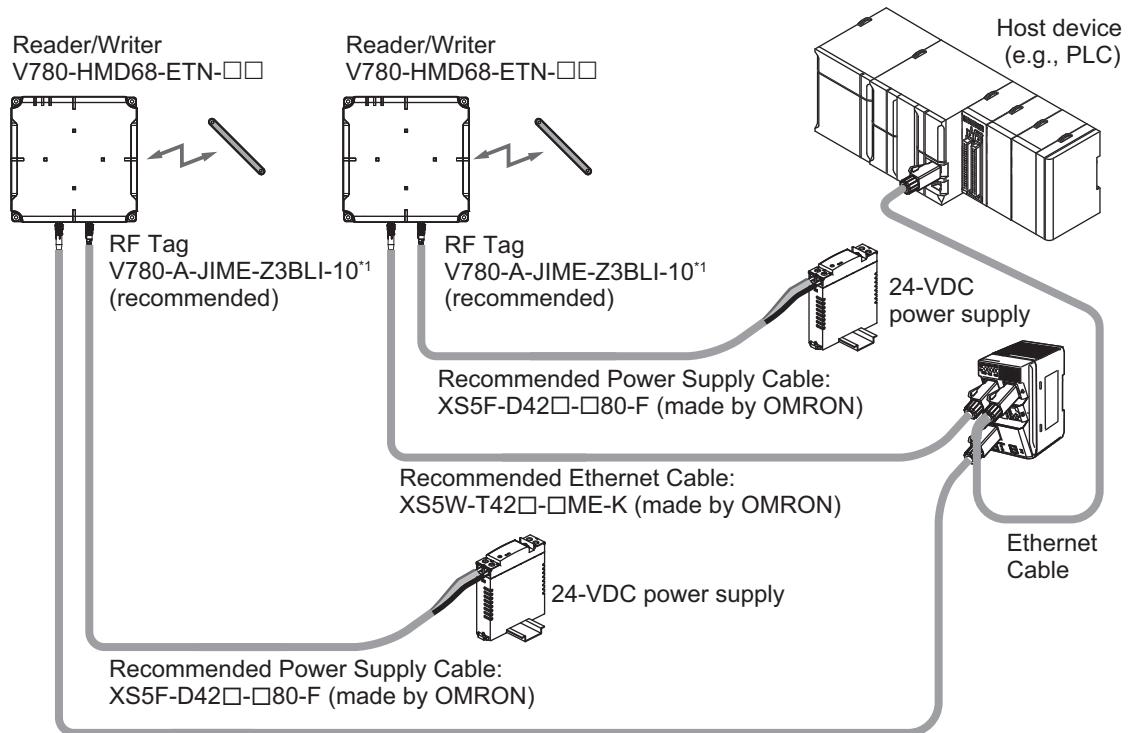

Recommended Ethernet Cable: XS5W-T42□-□ME-K (made by OMRON)

*1. This is the model number for one package of 10 RF Tags. Order the number of packages that you require.

● When the multi reader/writer function is used

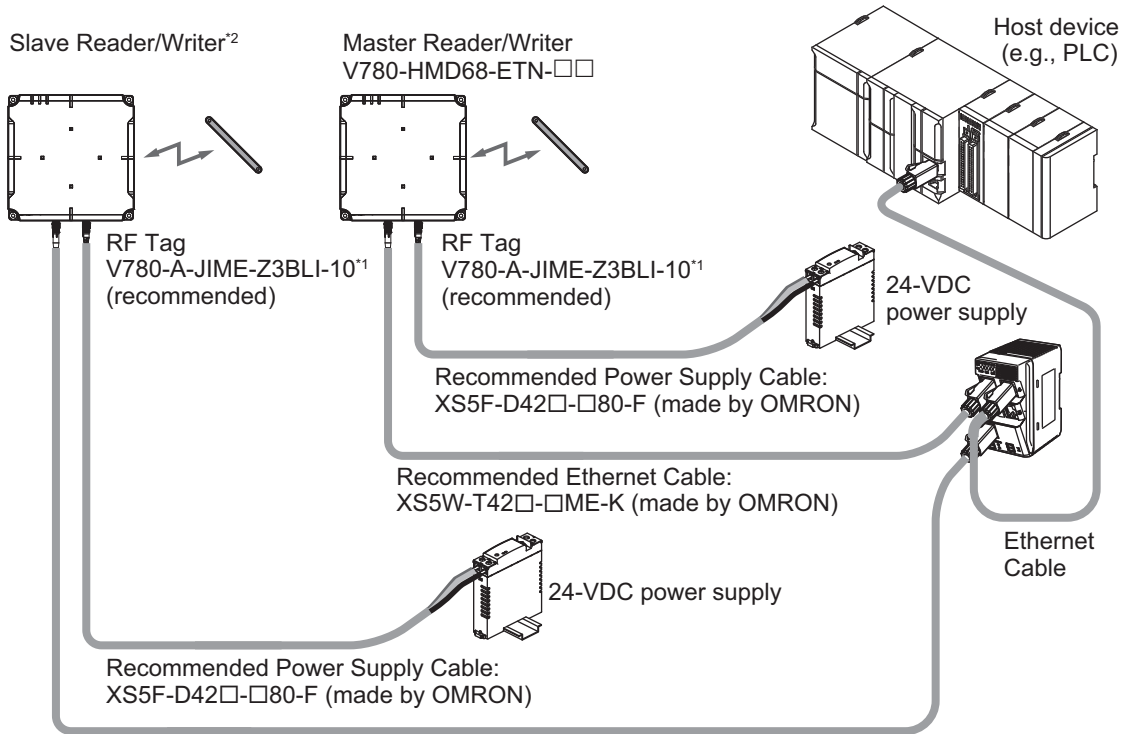

Recommended Ethernet Cable:
XS5W-T42□-□ME-K (made by OMRON)

*1. This is the model number for one package of 10 RF Tags.
Order the number of packages that you require.

*2. Communication is performed only via the master reader/writer. It can not be controlled from a host device such as PLC. But web server function is available.

Model		Slave Reader/Writer		
		V780-HMD68-ETN-□□ Standard Reader/Writer Modbus/TCP	V780-HMD68-EIP-□□ Standard Reader/Writer EtherNet/IP	V780-HMD68-ETN-□□-S Slave Reader/Writer Modbus/TCP
Master Reader/Writer	V780-HMD68-ETN-□□ Standard Reader/Writer Modbus/TCP	Available	Not available	Available
	V780-HMD68-EIP-□□ Standard Reader/Writer EtherNet/IP	Not available	Available	Available



Precautions for Correct Use

The slave reader/writer (V780-HMD68-ETN-□□- S) disconnects the connection when it sends a communication command directly from the host device such as PLC.

Use the slave reader/writer via the master reader/writer (V780-HMD68-ETN-□□).

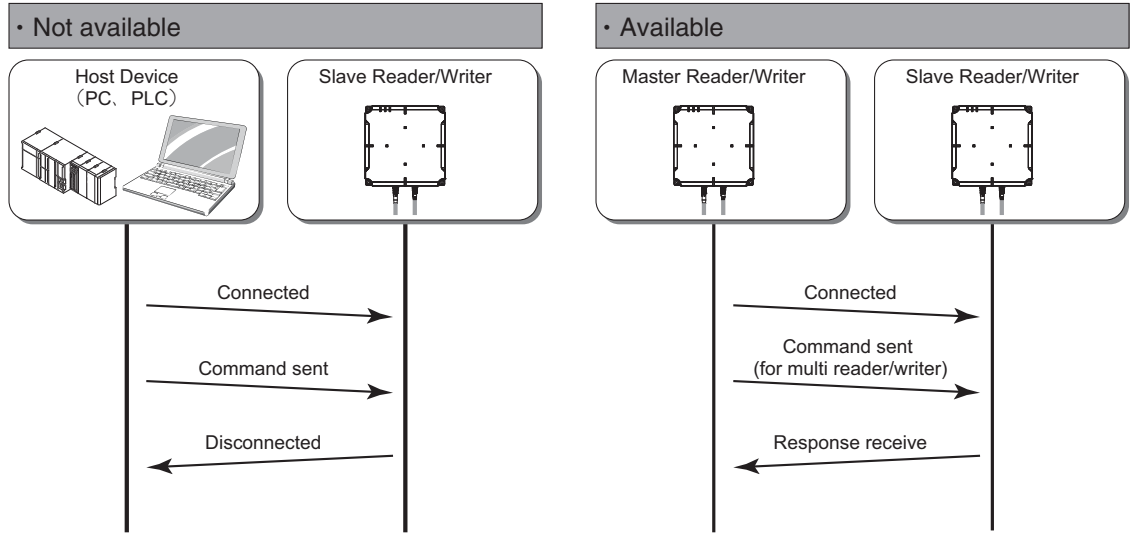

Host Device and a Computer

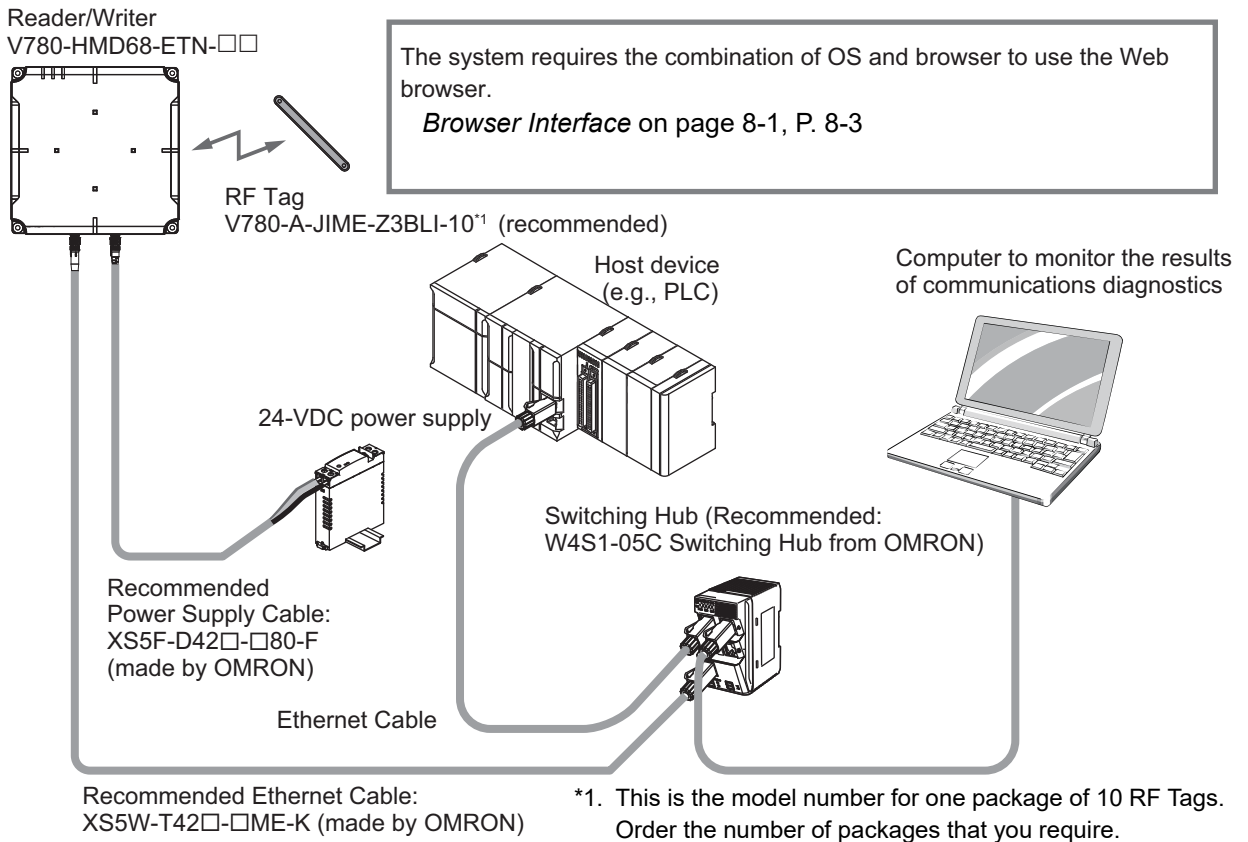

Connection to a Workpiece Detection Sensor

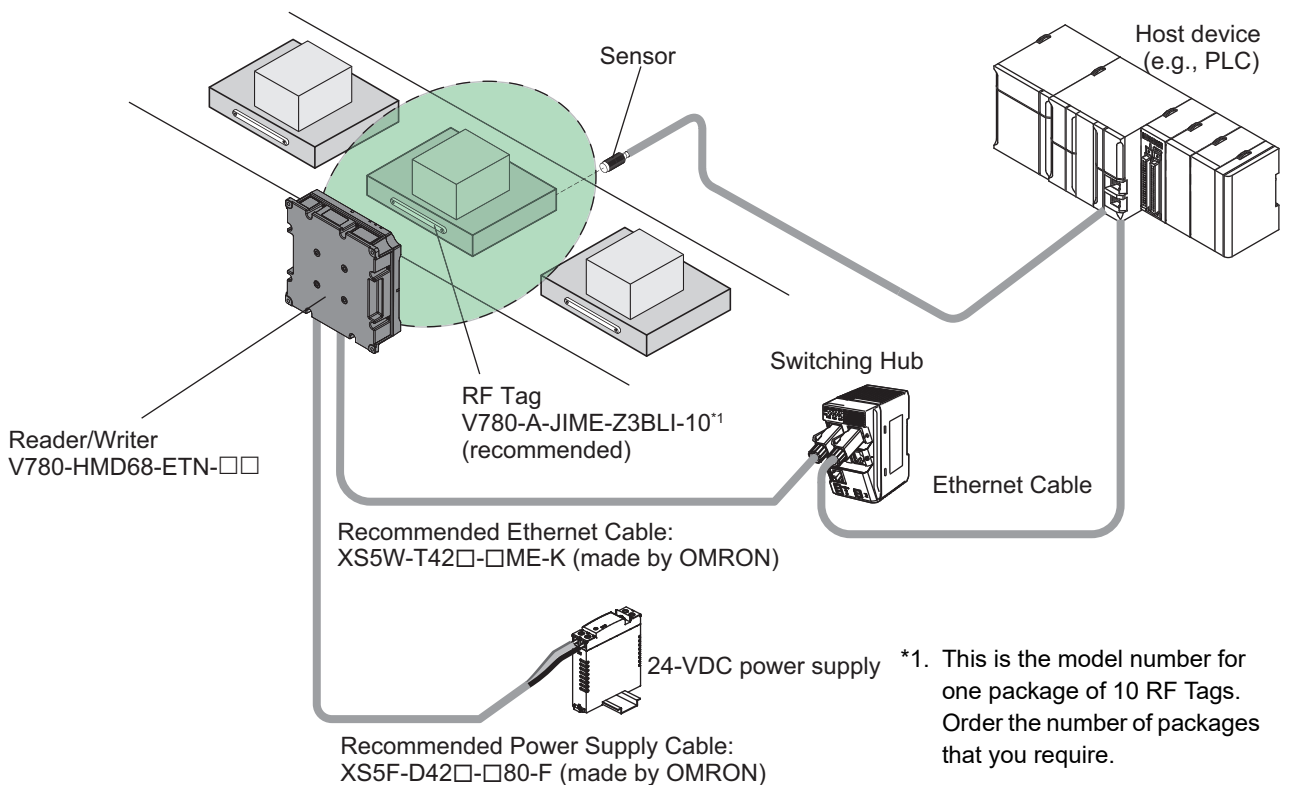



Precautions for Correct Use

- Ground the frame ground (GR) terminal on the power supply to 100 Ω or less. Otherwise, performance may deteriorate.
- The black wire in the Power Supply Cable (pin 4) is not used. Do not connect it to any terminal.
- To use the Reader/Writer in Run Mode, connect the control signal wire (white) to +24 VDC of the power supply. If you connect the control signal wire (white) to the 0-V side of the power supply, the Reader/Writer will start in Safe Mode.
- Connect a power supply that meets the following conditions to the Reader/Writer.

Item	Condition
Supply voltage	24 VDC -15% to $+10\%$
Output current	500 mA min.
Safety standard	SELV (Safety Extra Low Voltage)



Precautions for Correct Use

- The maximum total length of Ethernet Cable is 100 m.
 - The maximum total length of Power Supply Cable is 60 m.
 - Ask your OMRON representative for the recommended extension cables for the Ethernet Cable and Power Supply Cable.
-



Precautions for Safe Use

- Connect the Ethernet Cable to a host device (e.g., Switching Hub or PLC) that supports STP (shielded twisted-pair) and ground the host device to a ground resistance of 100 Ω or less.
-



Precautions for Correct Use

If you loop the Ethernet line, one broadcast packet may consume the entire bandwidth, preventing communications or possibly causing the Reader/Writer to stop operation. Do not create a loop in the Ethernet line when you connect it.

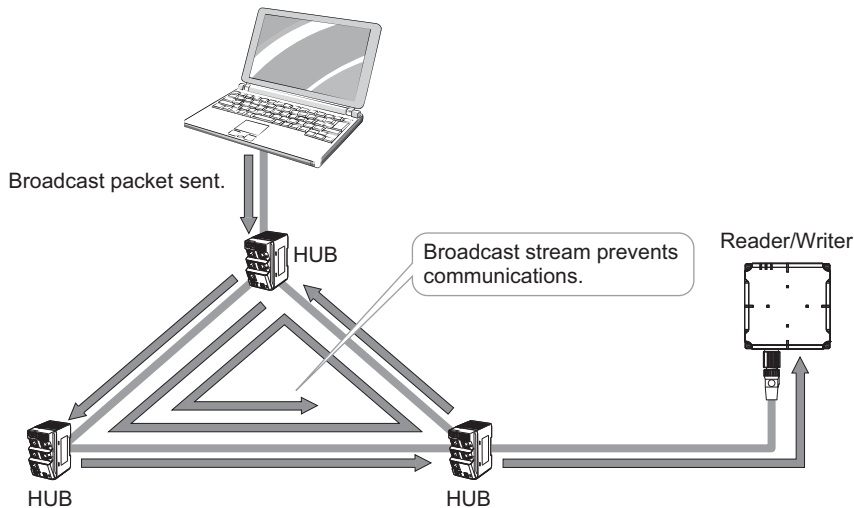

Also, if a large volume of broadcast packets or multicast packets are placed on the network, the Reader/Writer's response speed will drop and the Reader/Writer may even stop operating. Do not place a large volume of packets on the network in this way. Also, separate segments for the Reader/Writer from broadcast or multicast packets.

3

Part Names and Functions

This section describes the part names and functions of the V780 Reader/Writer.

3-1	Operation Indicators	3-2
3-1-1	Names and Descriptions of Operation Indicators	3-2
3-1-2	Operation Indicators at Startup	3-3
3-1-3	Operation Indicators for WDT Errors	3-4
3-1-4	Operation Indicators for IP Address Conflict	3-5
3-1-5	Operation Indicators When BOOTP Server Connection Fails	3-5
3-1-6	Operation Indicators during Command Execution	3-6
3-1-7	Operation Indicators during Test Execution	3-8
3-1-8	Operation Indicators for System Errors	3-9
3-1-9	During Multi-Reader/Writer function use	3-11
3-2	Connectors	3-13

3-1 Operation Indicators







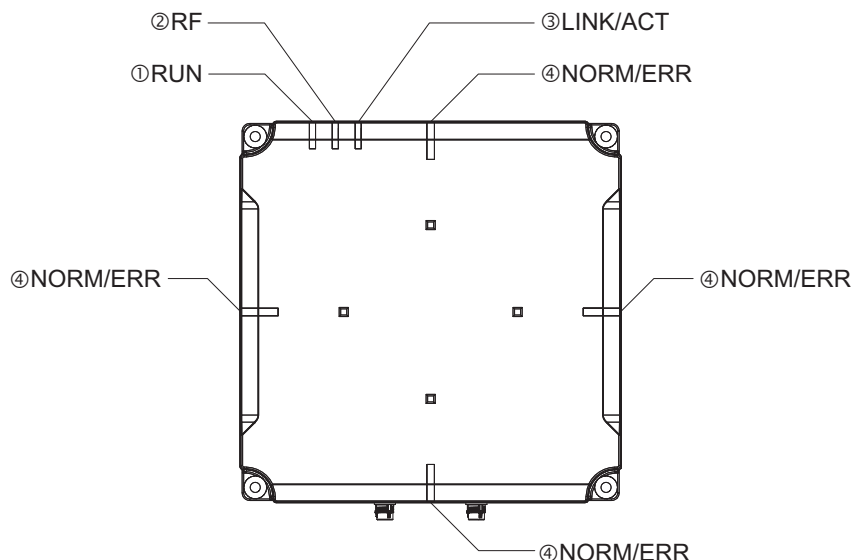

This section describes the operation indicators on the Reader/Writer.

3-1-1 Names and Descriptions of Operation Indicators

V780-HMD68-ETN-□□/V780-HMD68-ETN-□□-S



Number and name	Color	Status	Description
①RUN	Green		Flashing at 0.1-s intervals Flashes rapidly during startup.* ¹
			Flashing at 0.4-s intervals Flashes during operation in Safe Mode.
			Lit Lit during operation in Run Mode.
	Yellow		Lit Lit during operation in SLAVE Mode.
	Cyan		Lit Lit during test operation.* ²
	---		Not lit Not lit in the following cases. <ul style="list-style-type: none"> • When power is not being supplied • When there is a watchdog timer (WDT) error
②RF	Yellow		Lit Lit when a radio wave is being output. (Lit during communications with an RF Tag.)
			Not lit Not lit when a radio wave is not being output.
③LINK/ACT	Green		Lit Lit when a link has been established on the Ethernet port.
			Flashing irregularly Flashes during data communications on the Ethernet port.
			Not lit Not lit when a link has not been established on the Ethernet port.

Number and name	Color	Status	Description	
④NORM/ERR	Green		Lit for 0.2 s Lights once when processing a communications command or another command from the host device is completed normally.	
	Yellow		Lit for 0.2 s Flashes once each time an unstable communication is detected while communications diagnosis is enabled.	
	Red		Lit for 0.2 s	Lights once when processing a communications command or another command from the host device ends in an error.
			Lit	Lit when a major fault has occurred. (Lit when a fatal error has occurred.)
			Flashing at 0.4-s intervals	Flashes when a minor fault has occurred. (Flashes when a nonfatal error has occurred.)
		Flashing irregularly twice	Flashes when a minor fault has occurred. (Flashes when a network error occurs and the IP address becomes undetermined.)	
	Cyan		Flashing at 0.1-s intervals	Flashes during installation location notification.
			Flashing once every 3 s	Flashes during operation in the Focus Mode.
	---		Not lit	Not lit when the Reader/Writer is on standby.

- *1. This indicator flashes from startup until Run Mode or Save Mode is entered and during IP address queries when BOOTP is enabled.
- *2. "During test operation" includes Web browser interface adjustment and execution of utility functions.



Precautions for Correct Use

Refer to 9-1-1 *Errors Indicated on Operation Indicators* on page 9-2 for errors indicated by the operation indicators.

3-1-2 Operation Indicators at Startup

The Reader/Writer will start when you turn ON the power supply. The RUN indicator will flash at 0.1-s intervals while the Reader/Writer is starting.

IP address conflict detection will operate during Reader/Writer startup.

(If using the BOOTP client is enabled, detection will also operate during BOOTP server queries.)

The RUN indicator flashes green at 0.1-s intervals.
The LINK/ACT indicator does not light.

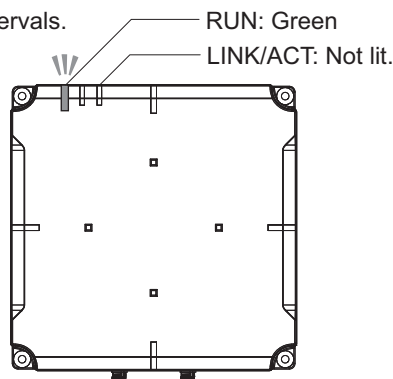

The RUN indicator will light when the Reader/Writer starts in Run Mode.

The LINK/ACT indicator will light when a link is established between the Reader/Writer and the Ethernet port.

The RUN indicator lights green.
The LINK/ACT indicator lights green.

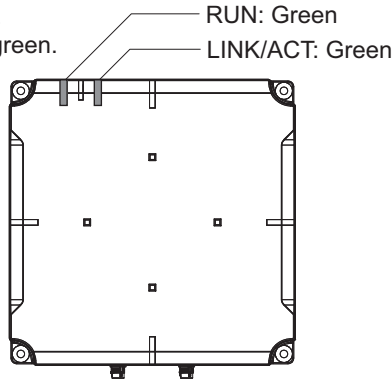

The RUN indicator will flash at 0.4-s intervals when the Reader/Writer starts in Safe Mode.

The LINK/ACT indicator will light when a link is established between the Reader/Writer and the Ethernet port.

The RUN indicator flashes green at 0.4-s intervals.
The LINK/ACT indicator lights green.

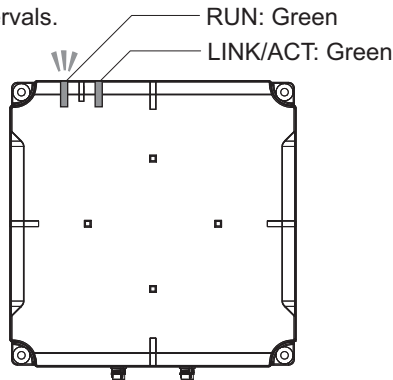

3-1-3 Operation Indicators for WDT Errors

If a WDT error is detected when the system runs out of control during operation, the RUN indicator will go out and the NORM/ERR indicators will light red.

This is a fatal error, so you must either restart or replace the Reader/Writer.

The RUN indicator does not light.
The NORM/ERR indicators light red.

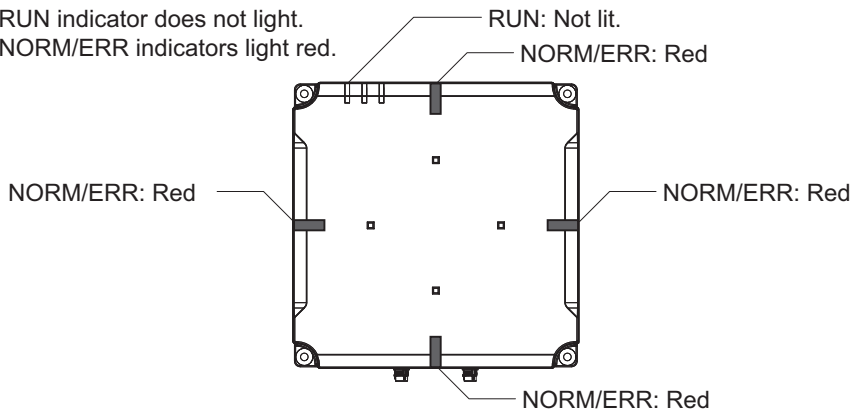

3-1-4 Operation Indicators for IP Address Conflict

IP address conflict detection will operate during Reader/Writer startup. The Reader/Writer conforms to RFC 5227 IP address conflict detection.

If the Reader/Writer detects another node with the same IP address on the same network, the NORM/ERR indicators will flash irregularly.

In this case, you must restart (i.e., cycle the power supply) the Reader/Writer to restore operation. IP address conflict detection does not operate while the Reader/Writer is in operation.

The RUN indicator flashes green at 0.1-s intervals.
 The LINK/ACT indicator does not light.
 The NORM/ERR indicators flash red irregularly (twice every second).

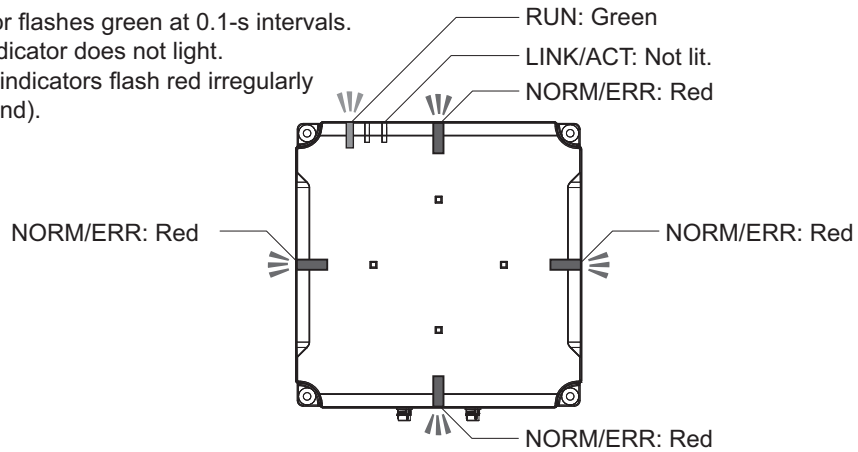

3-1-5 Operation Indicators When BOOTP Server Connection Fails

If using the BOOTP client is enabled, the Reader/Writer queries the BOOTP server at startup. If connecting to the server is not possible within a specific period of time or a suitable IP address is not available, the NORM/ERR indicators will flash irregularly.

The RUN indicator flashes green at 0.1-s intervals.
 The NORM/ERR indicators flash red irregularly (twice every second).

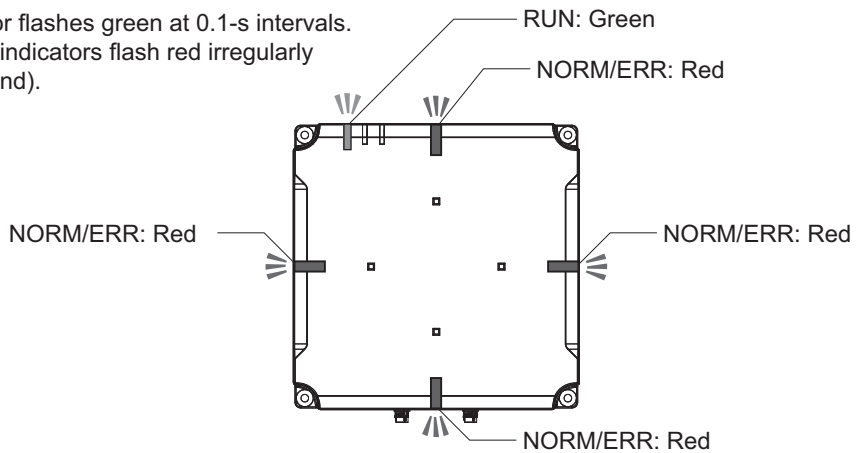

3-1-6 Operation Indicators during Command Execution

Communications Command Execution

The RF indicator will light yellow during communications between the Reader/Writer and RF Tag for execution of a command from the host device.

The RUN indicator lights green.
The RF indicator lights yellow.

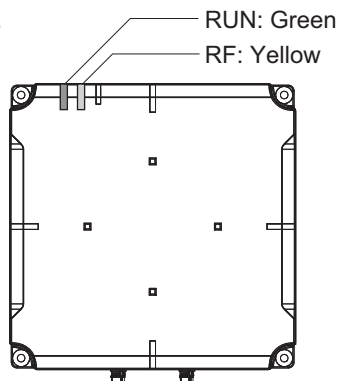

Normal Command Completion

The NORM/ERR indicators will flash green once when processing ends normally for execution of a command from the host device.

The RUN indicator lights green.
The NORM/ERR indicators flash green once.

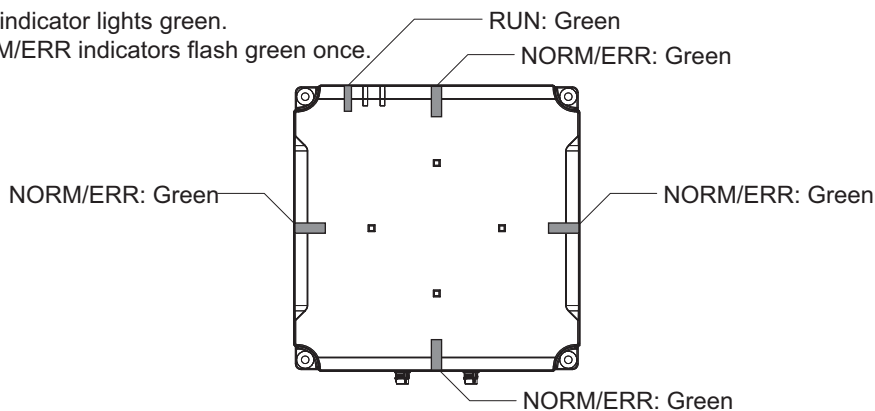

Normal Command Completion with Unstable Communications

The NORM/ERR indicators will flash yellow once when processing ends normally for execution of a command from the host device but the diagnosis results indicates unstable communications. The indication of unstable communications appears only when communications diagnosis is enabled.

The RUN indicator lights green.
The NORM/ERR indicators flash yellow once.

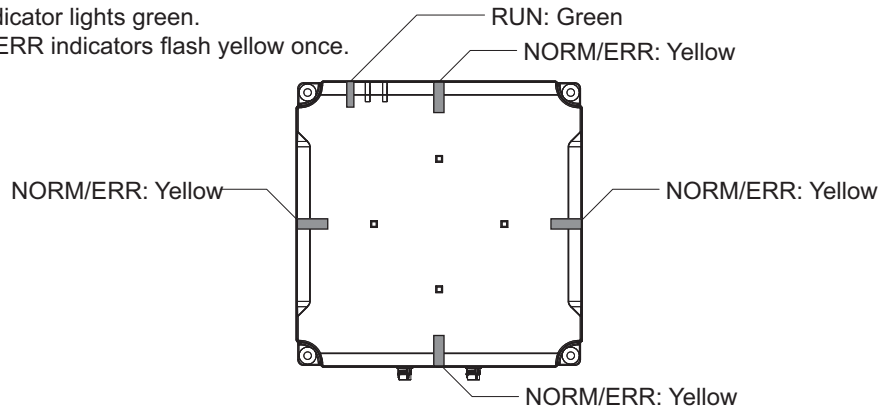

Error Command Completion

The NORM/ERR indicators will flash red once when processing ends in an error for execution of a command from the host device.

The RUN indicator lights green.
The NORM/ERR indicators flash red once.

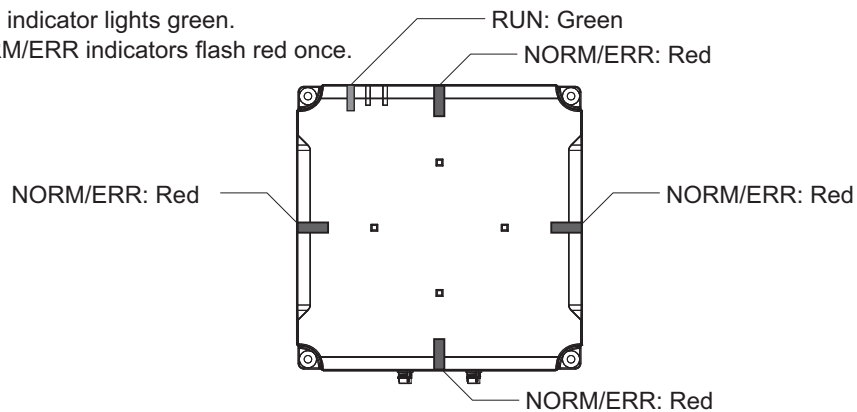

Operation Indicators during Focus Execution

The NORM/ERR indicators will flash cyan one time every three seconds and the RF indicator will light yellow during operation in Focus Mode. The NORM/ERR indicators will light green, yellow, or red according to the communications results of communications commands sent during Focus Mode.

- The RUN indicator lights green.
- The RF indicator lights yellow.
- The LINK/ACT indicator does not light.
- The NORM/ERR indicators flash cyan (once every 3 s).

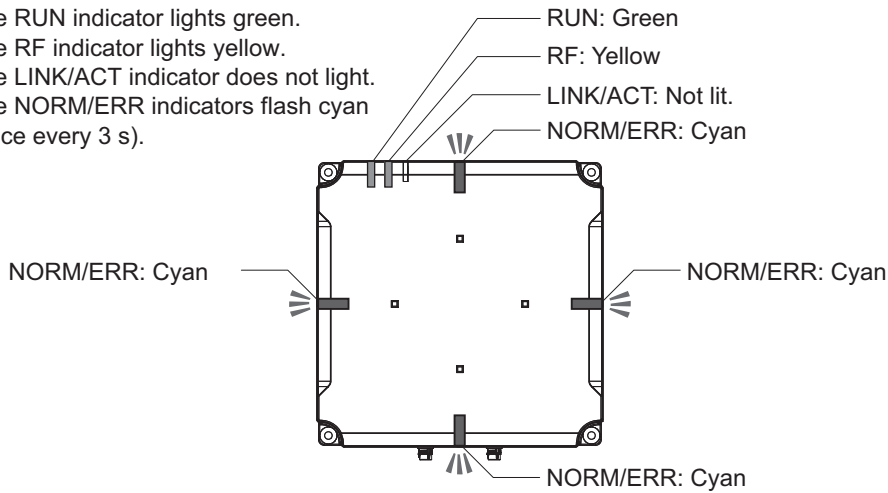

3-1-7 Operation Indicators during Test Execution

Test Execution

The RUN indicator will light cyan during execution of test functions from the Web browser interface.

- The RUN indicator lights cyan.
- The LINK/ACT indicator does not light.
- The NORM/ERR indicators do not light.

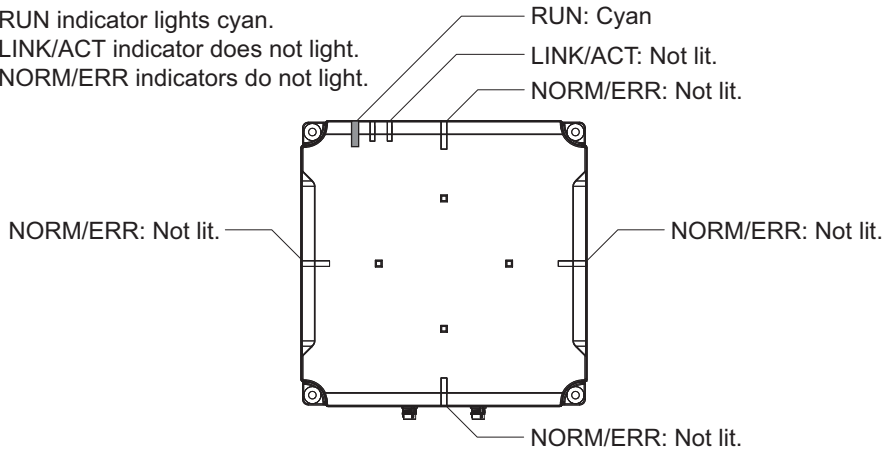

Operation Indicators during Single-access Communications for Reception Level Monitoring

The NORM/ERR indicators will flash according to the reception power of the RF Tag during single-access communications testing for the Reception Level Monitor of the Web browser interface.

The RUN indicator lights cyan.
 The LINK/ACT indicator does not light.
 The NORM/ERR indicators flash green at 0.4-s intervals.

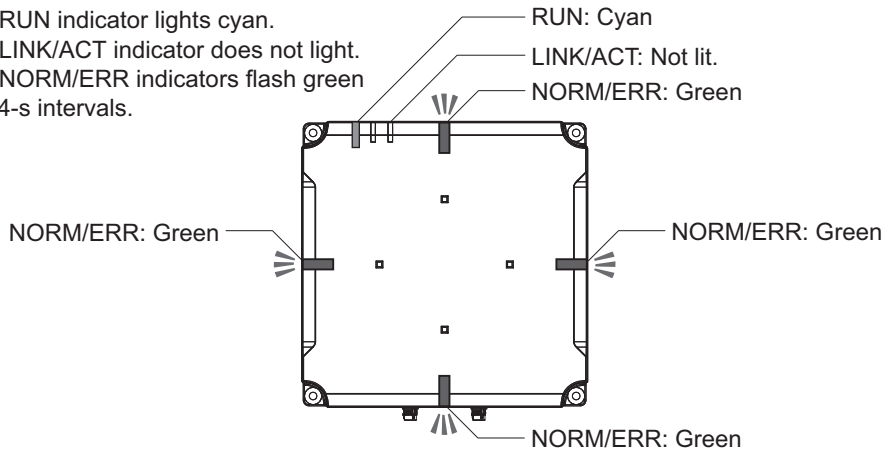

3-1-8 Operation Indicators for System Errors

Minor Faults

If a minor fault is detected, the NORM/ERR indicators will flash red at 0.4-second intervals.

To recover normal operation, initialize the Reader/Writer settings and then restart the Reader/Writer.

However, if an illegal network setting or an incorrect operating mode is detected during operation, the RUN indicator will flash red and the Reader/Writer will start in Safe Mode.

The RUN indicator lights green.
 The NORM/ERR indicators flash red at 0.4-s intervals.

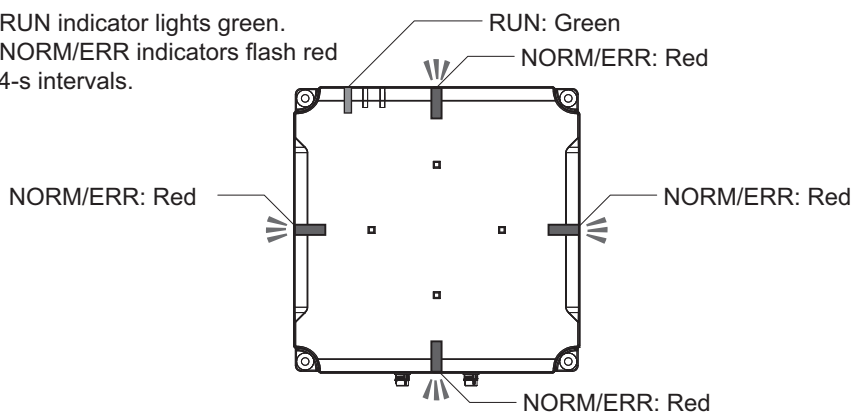

Illegal Network Setting or Incorrect Operating Mode Detection during Operation

The Reader/Writer starts in Safe Mode.
 The RUN indicator flashes green
 at 0.4-s intervals.
 The NORM/ERR indicators flash red
 at 0.4-s intervals.

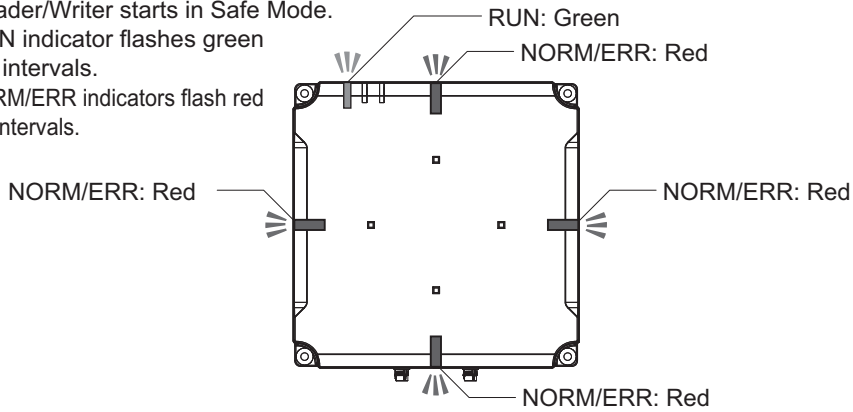

Major Faults

If a major fault is detected, the NORM/ERR indicators will light red. This is a fatal error, so you must replace the Reader/Writer.

If a major fault occurs during startup, the RUN indicator will flash and the Reader/Writer will start in Safe Mode.

The RUN indicator lights green.
 The NORM/ERR indicators light red.

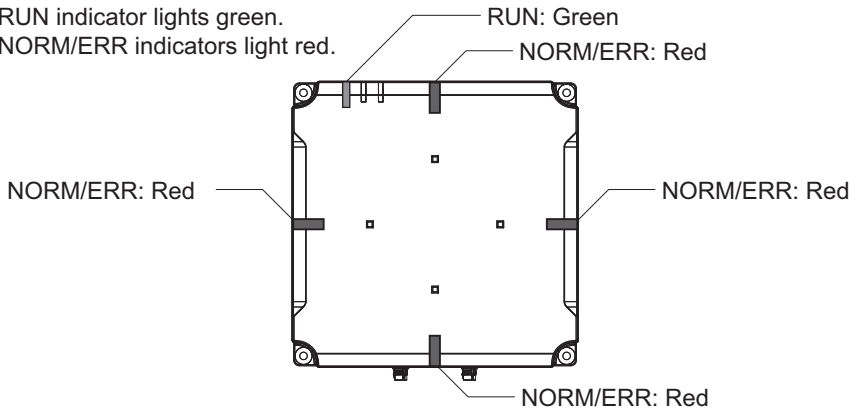

Major Fault Detection during Operation

The RUN indicator flashes green
 at 0.4-s intervals.
 The NORM/ERR indicators light red.

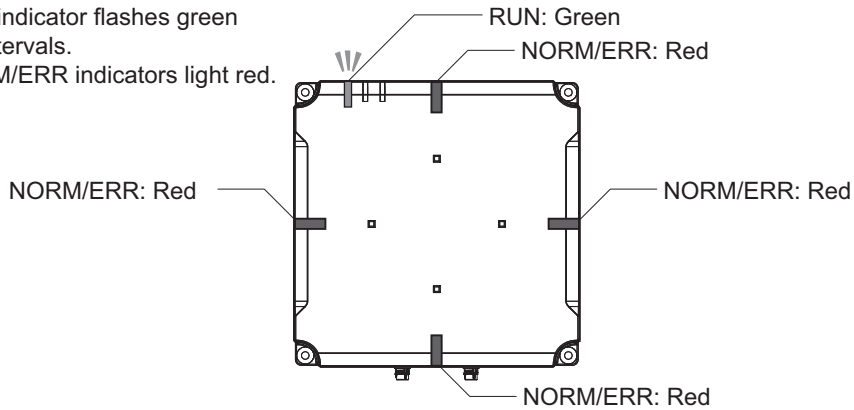

3-1-9 During Multi-Reader/Writer function use

SLAVE Mode

The RUN indicator will light yellow when a group-registered Reader/Writer is switched to from the master reader/writer and operates as a slave reader/writer.

The RUN indicator lights yellow.

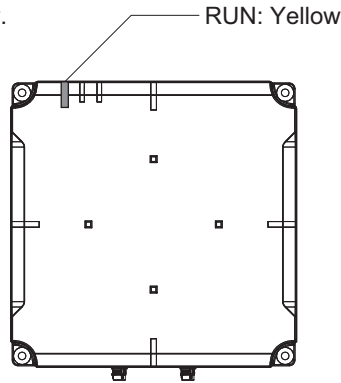

Normal completion of slave Reader/Writer command

The NORM/ERR indicators will light green once when processing ends normally for commands execution issued from the master Reader/Writer.

The RUN indicator lights yellow.
The NORM/ERR indicators flash green once.

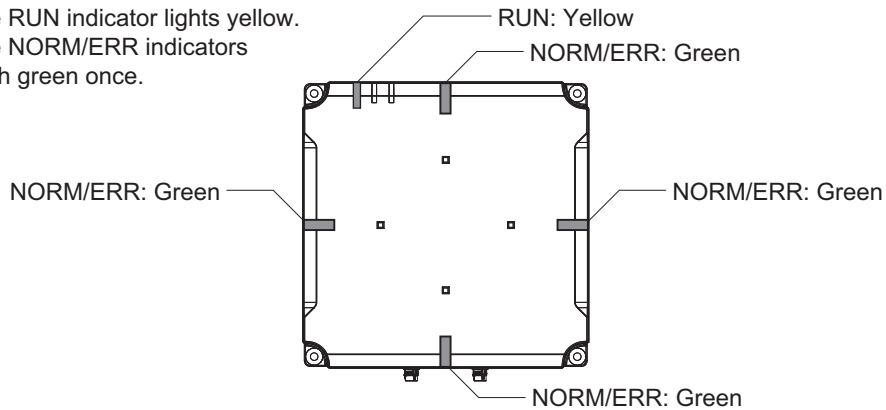

Abnormal completion of slave Reader/Writer command

The NORM/ERR indicators will light red once when processing ends abnormally for commands execution issued from the master Reader/Writer.

The RUN indicator lights yellow.
The NORM/ERR indicators flash red once.

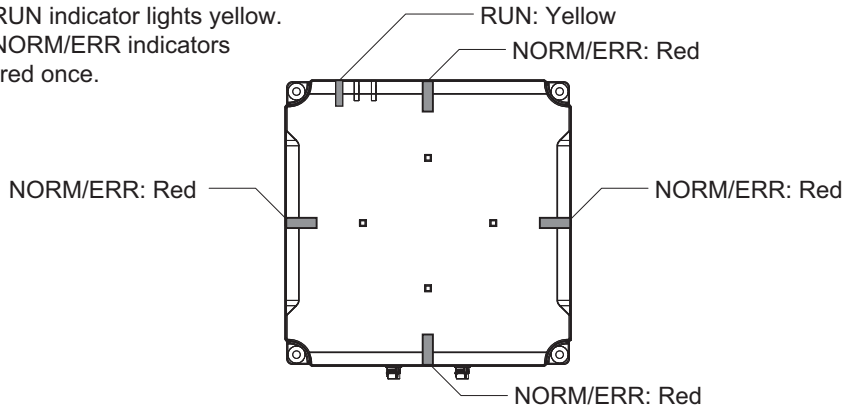

3-2 Connectors

This section describes the connectors on the Reader/Writer.

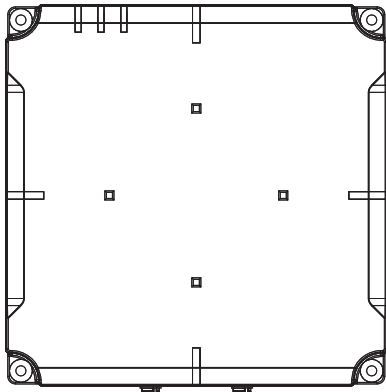

Ethernet connector — Power supply connector

● Power Supply Connector

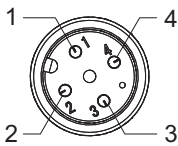

Size	Opening shape	Polarity	Pin No.	Name	Description	I/O
M12	Receptacle	Male	1	24P	+24 V	---
			2	CONT	Control signal (operating mode signal) *1. Run Mode: Connect to 24 V and then start the Reader/Writer. Safe Mode: Connect to 0 V and then start the Reader/Writer.	IN
			3	24N	0 V	---
			4	---	---	---

● Ethernet Connector

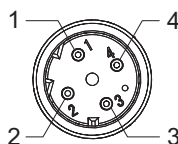

Size	Opening shape	Polarity	Pin No.	Name	Description	I/O
M12	Receptacle	Male	1	TD+	Ethernet send + signal	OUT
			2	RD+	Ethernet receive + signal	IN
			3	TD-	Ethernet send - signal	OUT
			4	RD-	Ethernet receive - signal	IN
			Housing	FG	Frame ground	---



Installation and Connections

This section describes the installation methods, wiring methods, and installation locations for the V780 Reader/Writer in detail.

4-1	Installation	4-2
4-1-1	Reader/Writer	4-2
4-1-2	RF Tags	4-4
4-2	Connections and Wiring	4-6
4-2-1	Connecting and Removing the Reader/Writer Power Cable and Ethernet Cable	4-6

4-1 Installation

This section describes the installation of the Reader/Writer and RF Tags.

4-1-1 Reader/Writer

V780-HMD68-ETN-□□/V780-HMD68-ETN-□□-S

The Reader/Writer can be installed from the front or the rear.

● Front Mounting

Install the Reader/Writer with four M6 bolts. Use both spring washers and flat washers.

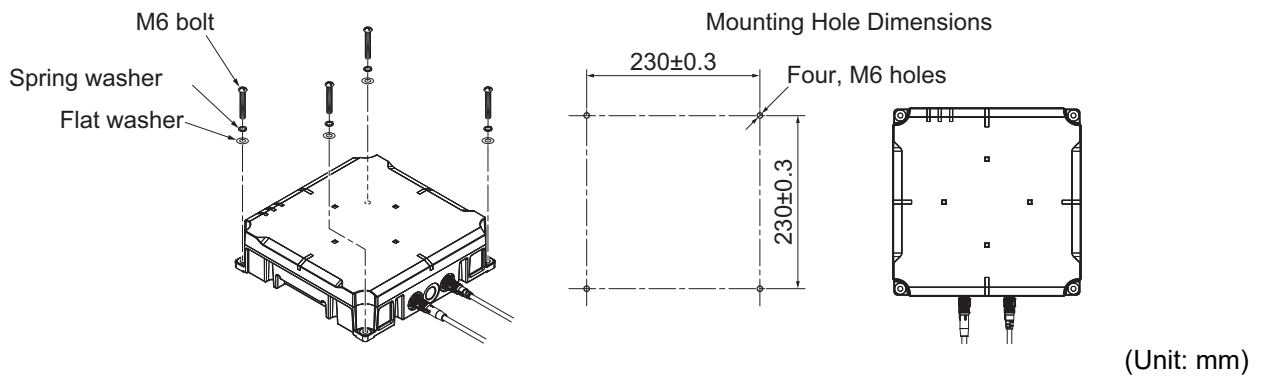

● Rear Mounting

Install the Reader/Writer with four M6 bolts. Use both spring washers and flat washers.

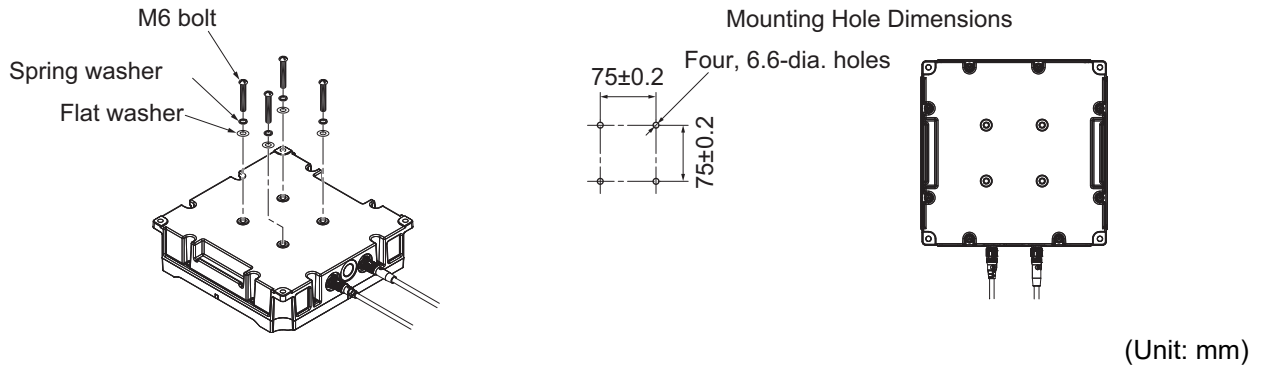

* If it is necessary to distinguish the appearance of the standard Reader / Writer (V780-HMD68-ETN- □□ / -EIP- □□) and the slave Reader / Writer (V780-HMD68-ETN- □□ -S), please take measures such as attaching a non-metallic label.

⚠ WARNING

- Injury may occur if the Reader/Writer falls and strikes a person. When you install the Reader/Writer, observe the tightening torque (4.3 N·m) for the M6 bolts.



Precautions for Correct Use

- An M6 bolt engagement length of 6 to 8 mm is necessary for rear mounting.
- The bolts may be hard to tighten. Tighten them to the recommended tightening torque.



Precautions for Safe Use

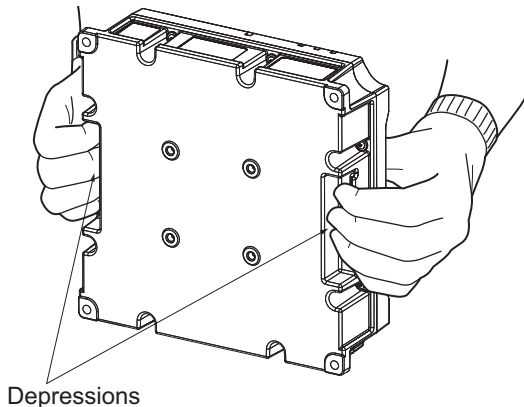
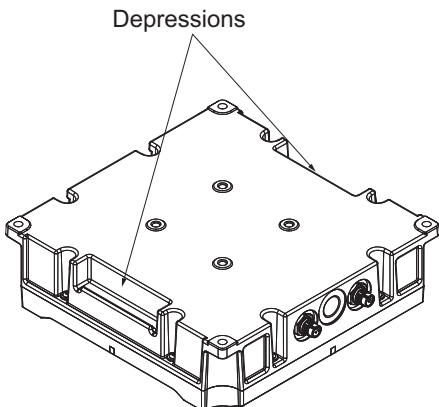

- The Reader/Writer weighs approx. 3 kg. It may be damaged if it falls. Use slip-resistant gloves when you install the Reader/Writer and hold the Reader/Writer securely at the depressions with both hands.
- Use slip-resistant gloves when you install the Reader/Writer. The Reader/Writer may be destroyed if it falls.



Additional Information

- For details on connection methods, refer to 4-2 *Connections and Wiring* on page 4-6.

● Mounting Ferrite Cores

(Model V780-HMD68-ETN-EU/-IN/-RU/-EU-S/-IN-S/-RU-S)

- 1** Wind the power cable and the Ethernet cable once to the ferrite core individually. Attach the ferrite core to the cable at the Reader/Writer side.

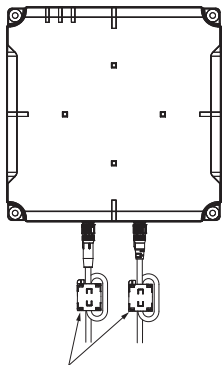

Ferrite cores

- 2** Close the ferrite core until it clicks into place.

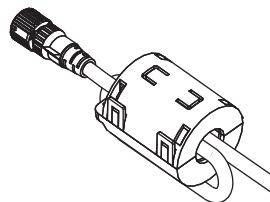
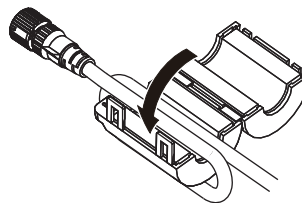

4-1-2 RF Tags

Mounting on Non-metallic Material (RF Tags Only)

- 1 Use two, M4 screws to mount the RF Tags from the marked side.
The tightening torque is 1.2 N·m.
The V780-A-TA-133-10^{*1} Attachment is not necessary.

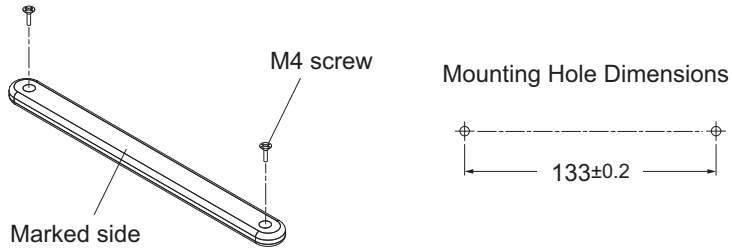

- *1. This is the model number for one package of 10 RF Tags.
Order the number of packages that you require.



Precautions for Correct Use

An M4 screw mating length of 4 mm or longer is necessary when mounting an RF Tag to a non-metallic material.

Mounting on Metallic Material (RF Tag and Attachment)

Mount the V780-A-JIME-Z3BLI-10^{*1} RF Tag in the V780-A-TA-133-10^{*1} Attachment, and then mount the Attachment to the metallic material.



Precautions for Correct Use

If you mount a V780-A-JIME-Z3BLI-10^{*1} RF Tag to a metallic material, use a V780-A-TA-133-10^{*1} Attachment. The communications distance will decrease drastically if there is metal at the back of the RF Tag.

- 1 Mount the RF Tag in the Attachment.
Use two M4 screws and tighten the nuts from the marked side of the RF Tag.
The tightening torque is 1.2 N·m.

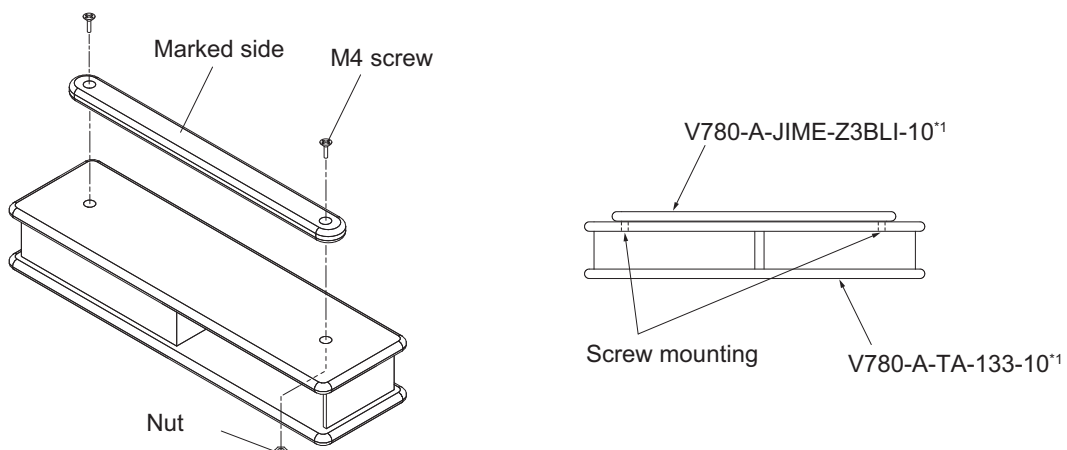

- 2** Mount the Attachment to which the RF Tag is mounted to the metallic material.
Mount it with two M4 bolts.
The tightening torque is 1.2 N·m.

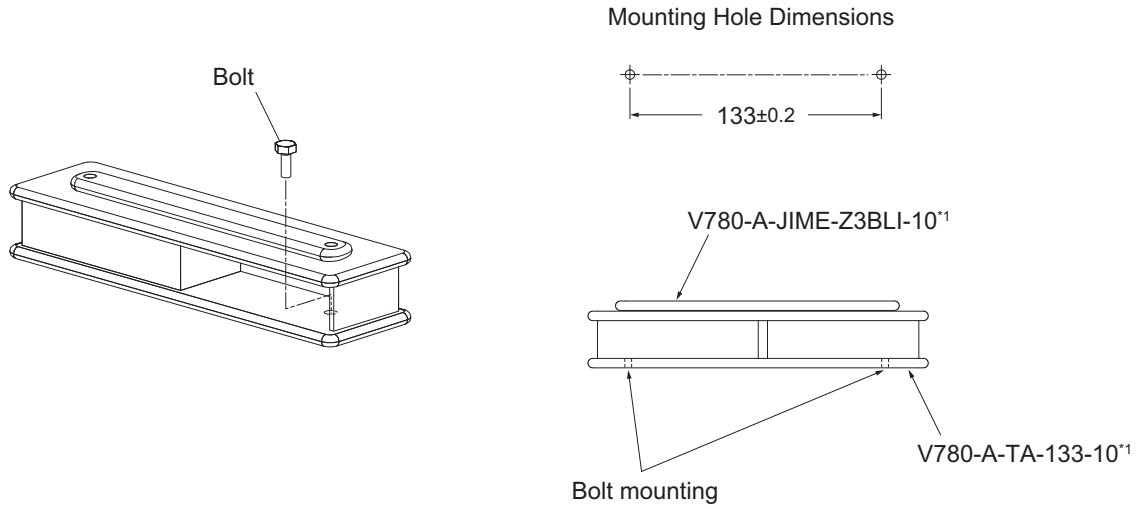

- *1. This is the model number for one package of 10 RF Tags.
Order the number of packages that you require.



Precautions for Correct Use

- An M4 screw mating length of 4 mm or longer is necessary when mounting an RF Tag and Attachment.
- An M4 bolt mating length of 4 mm or longer is necessary when mounting an RF Tag mounted in an Attachment to a metallic material.

4-2 Connections and Wiring

4-2-1 Connecting and Removing the Reader/Writer Power Cable and Ethernet Cable

Power Supply

Connect a power supply that meets the following conditions to the Reader/Writer.

Item	Condition
Supply voltage	24 VDC -15% to +10%
Output current	500 mA min.
Safety standard	SELV (Safety Extra Low Voltage)

Connecting Method

- 1 Hold onto the connector on the Power Cable and insert it into the power connector on the Reader/Writer.

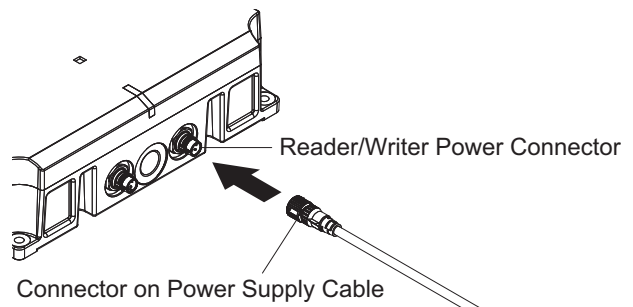

Precautions for Correct Use

Do not apply more than 30 N of force to the connector on the Reader/Writer.

- 2 Turn the connector on the Power Cable clockwise to lock it in place.
 - For the Recommended Cable
Turn the cable connector clockwise until you hear it securely lock in place.
 - For Other Cables
Observe the tightening torque specifications for the cable connectors.

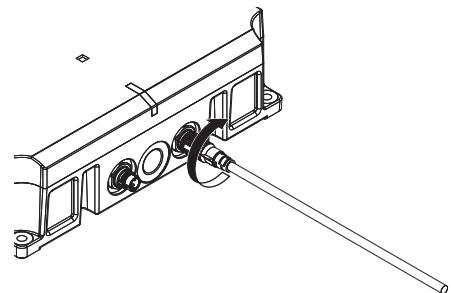

Pin No.	Name	Description	I/O
1	24P	+24 V	---
2	CONT	Control signal (operating mode signal) *1. Run Mode: Connect to +24 V and then start the Reader/Writer. Safe Mode: Connect to 0 V and then start the Reader/Writer.	IN
3	24N	0 V	---
4	---	---	---



Precautions for Correct Use

Pin 4 on the power supply connector is not used. Do not connect it to any terminal.



Additional Information

- To use the Reader/Writer in Run Mode, connect the control signal to +24 VDC of the power supply. If you connect the control signal to the 0-V side of the power supply, the Reader/Writer will start in Safe Mode.
- Refer to 6-1 Operation Modes on page 6-3 for information on Run Mode and Safe Mode.
- Connector Layout and Wire Diagram of Recommended Cable (XS5F-D42□-□80-F)

Connector Layout



Wiring Diagram (Four Conductors)

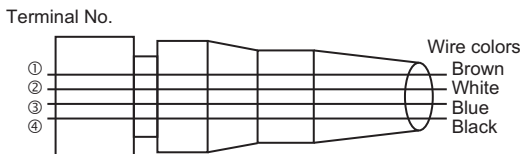

- 3 Hold onto the connector on the Ethernet Cable and insert it into the Ethernet connector on the Reader/Writer.

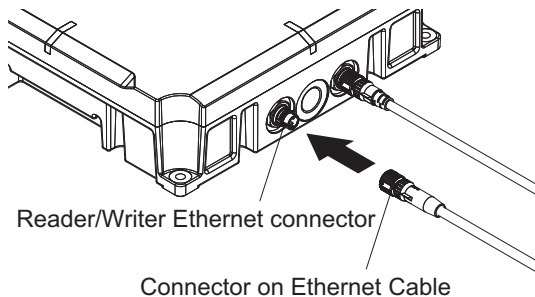

Precautions for Correct Use

Do not apply more than 30 N of force to the connector on the Reader/Writer.

- 4 Turn the connector on the Ethernet Cable clockwise to lock it in place.
 - For the Recommended Cable
Turn the cable connector clockwise until you hear it securely lock in place.
 - For Other Cables
Observe the tightening torque specifications for the cable connectors.

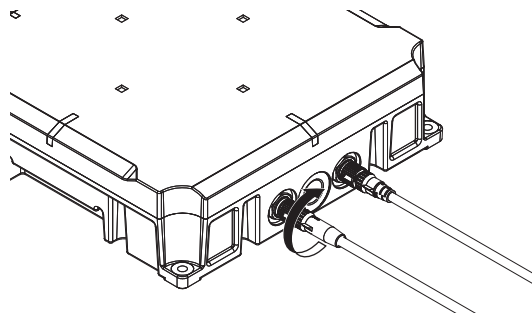

Pin No.	Name	Description	I/O
1	TD+	Ethernet send + signal	OUT
2	RD+	Ethernet receive + signal	IN
3	TD-	Ethernet send - signal	OUT
4	RD-	Ethernet receive - signal	IN
Housing	FG	Frame ground	---

Removal Method

- 1 Turn the connector on the Power Cable counterclockwise to unlock it.

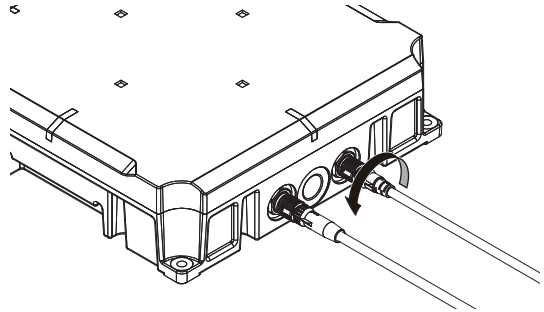

- 2 Hold onto the connector on the Power Cable and pull it straight out to remove it.

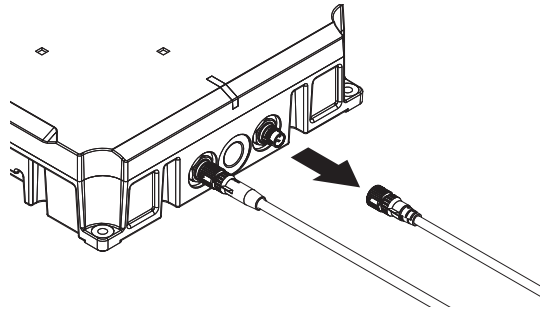

Precautions for Correct Use

If the connector is difficult to remove, press on the Reader/Writer and pull on the connector. Never pull on the Cable with excessive force. Doing so may break the wires and cause malfunction.

- 3 Turn the connector on the Ethernet Cable counterclockwise to unlock it.

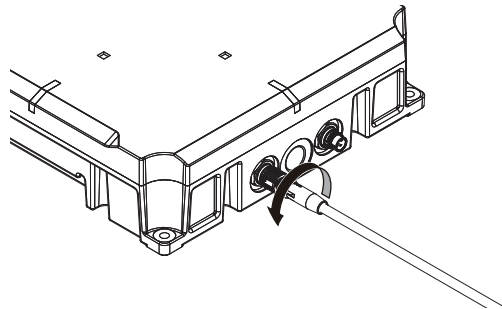

- 4 Hold onto the connector on the Ethernet Cable and pull it straight out to remove it.

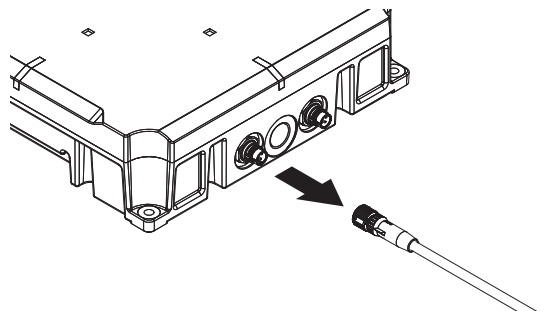



Precautions for Correct Use

If the connector is difficult to remove, press on the Reader/Writer and pull on the connector. Never pull on the Cable with excessive force. Doing so may break the wires and cause malfunction.

5

Preparations for Communications

This section describes how to set up communications with the V780 Reader/Writer.

5-1	Starting the Reader/Writer	5-2
5-1-1	Procedure to Start the Reader/Writer	5-2
5-2	Setting IP Addresses	5-3
5-2-1	Preparations for Work	5-3
5-2-2	Setting the IP Address of the Reader/Writer from a Web Browser	5-4

5-1 Starting the Reader/Writer

5-1-1 Procedure to Start the Reader/Writer

- 1** Connect the Cable to the Reader/Writer.



Additional Information

Refer to *4-2-1 Connecting and Removing the Reader/Writer Power Cable and Ethernet Cable* on page 4-6 for the methods to attach and connect the Reader/Writer Power Supply Cable and Ethernet Cable.

- 2** Connect the power supply lines and the operation mode signal line in the Cable to the power source and connect the RJ45 connector to an Ethernet port on the host device.
- 3** Turn ON the power supply to start the Reader Writer.
If the Reader Writer starts normally, the RUN indicator will light green.

5-2 Setting IP Addresses

5-2-1 Preparations for Work

1 Network Configuration

The network configuration that is described in this manual is shown in the following figure. Connect the Reader/Writer and the computer with an Ethernet Cable.

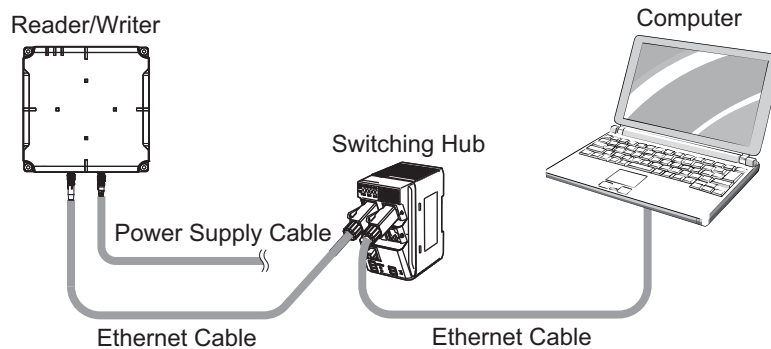

2 Set the IP address on the computer.

Set the IP addresses on the computer.

The default IP addresses of the Reader/Writer are given in the following table. Use these addresses to set the IP address on the computer.

This example changes the last part of the IP address to a value other than 200 (i.e., to 1 to 199 or 201 to 254). Values of 0 and 255 cannot be used.

- Default IP Address Settings of the Reader/Writer

Setting item	Default setting
IP address	192.168.1.200 (fixed setting)
Subnet mask	255.255.255.0 (fixed setting)
Default gateway	192.168.1.254 (fixed setting)

Setting the IP Address on the Computer with Windows 7 or Windows 10

- 1 Open the Control Panel, and select **Network and Internet** and then **Network and Sharing Center**.
- 2 Select **Change adapter settings** and then right-click **Local Area Connection**.
- 3 Right-click **Local Area Connection** and select **Properties**.
- 4 Select **Internet Protocol Version 4 (TCP/IPv4)** and then click the **Properties** Button.
- 5 Select the *Use the following IP address* Option, make the following settings, and then click the **OK** Button.
Change the last part of the IP address to a value other than 200 (i.e., to 1 to 199 or 201 to 254). Values of 0 and 255 cannot be used.
- 6 Click the **OK** Button to close the Internet Protocol Version 4 (TCP/IPv4) Properties Dialog Box.

5-2-2 Setting the IP Address of the Reader/Writer from a Web Browser

1 Start the Web browser.

Enter the IP address of the Reader/Writer in the address field of the Web browser to display the Browser Operation Window. Enter `http://192.168.1.200` if you are using the default IP address.

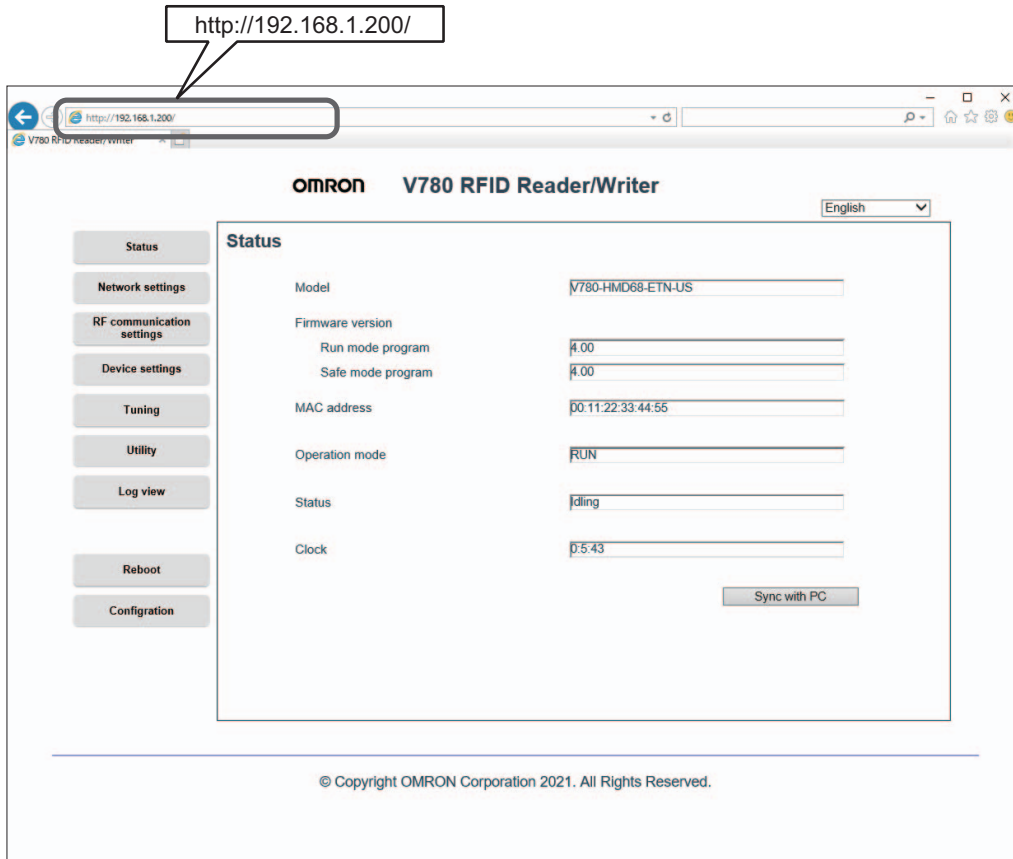

2 Set the IP address of the Reader/Writer.

Click the **Network settings** Button at the upper left of the Web Browser Operation Window.

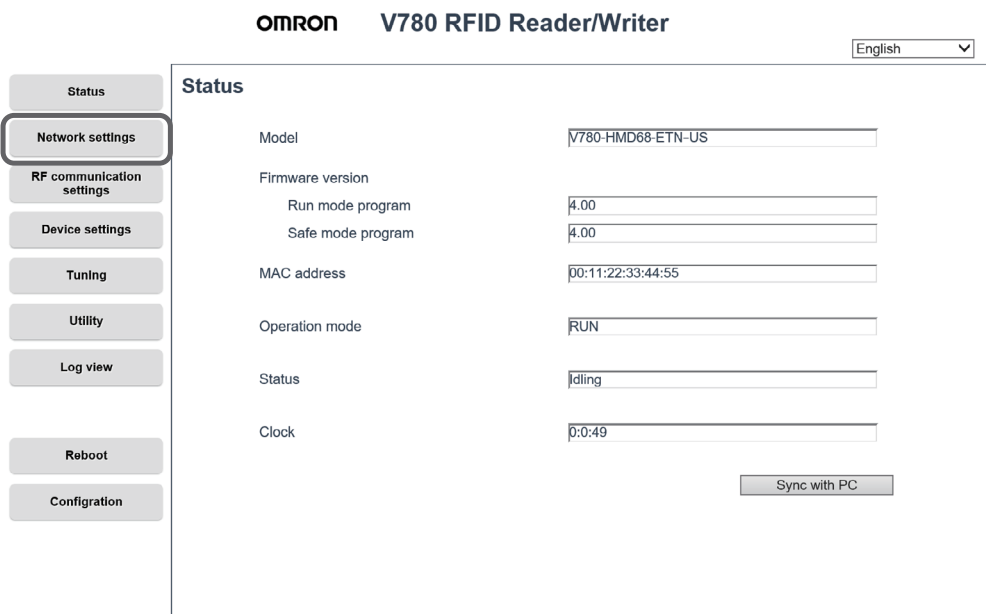

The Network settings View will be displayed.

● Setting a Fixed IP Address

On the Network Settings View, select the *Fixed setting* Option, enter the IP address, subnet mask, and gateway address, and then click the **Set** Button.

The screenshot shows the 'Network settings' page for the OMRON V780 RFID Reader/Writer. The 'TCP/IP settings' tab is active. The 'Fixed setting' radio button is selected and circled. The IP address is set to 192.168.1.200, the subnet mask to 255.255.255.0, and the gateway address to 192.168.1.254. There are also options for 'Obtain from BOOTP server' and 'Fix at the IP address which is obtained from BOOTP server'. A 'Set' button is visible at the bottom right.

● Getting an IP Address from a BOOTP Server

On the Network Settings View, select the *Obtain from BOOTP server* Option or the *Fix at the IP address which is obtained from BOOTP server* Option, and then click the **Set** Button.

The screenshot shows the 'Network settings' page for the OMRON V780 RFID Reader/Writer. The 'TCP/IP settings' tab is active. The 'Obtain from BOOTP server' radio button is selected and circled. The IP address, subnet mask, and gateway address fields are present but disabled. There is also an option for 'Fix at the IP address which is obtained from BOOTP server'. A 'Set' button is visible at the bottom right.

3 Paste the IP address memo label.

Write the set IP address on the IP address memo label and paste it on the target reader/writer.

6

Functions

This section describes the functions that you can use with a V780 Reader/Writer.

6-1	Operation Modes	6-3
6-1-1	Run Mode	6-3
6-1-2	Safe Mode	6-3
6-2	RF Tag Communications	6-4
6-2-1	Single-access Communications	6-4
6-2-2	Multiaccess Communications	6-5
6-2-3	RF Communications Modes	6-6
6-2-4	Communications Commands	6-13
6-3	Reader/Writer Controls	6-18
6-3-1	Initialization	6-18
6-3-2	Resetting	6-18
6-3-3	Stopping	6-19
6-3-4	RESET FOCUS	6-20
6-3-5	Installation Location Notification	6-21
6-4	Reader/Writer Settings	6-22
6-4-1	Network Settings	6-22
6-4-2	RF Communications Conditions: Basic Settings	6-24
6-4-3	RF Communications Conditions: Advanced Settings	6-26
6-4-4	Device Settings	6-31
6-4-5	Exporting/Important Configuration Files	6-33
6-5	Maintenance: Device Information	6-34
6-5-1	Reading Device Information	6-34
6-5-2	Getting the Operating Status	6-34
6-5-3	Getting and Setting Time Information	6-34
6-6	Maintenance: Log Information	6-35
6-6-1	Getting and Clearing the System Error Log	6-35
6-6-2	Getting the Command Error Log	6-36
6-6-3	Getting the Most Recent Command Error Information	6-36
6-7	Maintenance: Communications Information	6-37
6-7-1	Getting the Reception Level	6-37
6-7-2	Getting the Noise Level	6-37
6-7-3	Communications Diagnostics	6-38

6-8 Tuning	6-43
6-8-1 Transmission Power Tuning	6-43
6-9 Utilities	6-46
6-9-1 RF Tag Access	6-46
6-9-2 RF Tag Scanning	6-47
6-9-3 Reception Level Monitor	6-48
6-9-4 Channel Monitor	6-52
6-9-5 Focus Monitor	6-53
6-10 Multi-Reader/Writer Function	6-56
6-10-1 Outline	6-56
6-10-2 Multi-Reader/Writer Modes	6-57
6-10-3 Application	6-62
6-10-4 Communications conditions during Multi-Reader/Writer use	6-69
6-10-5 Maintenance functions during Multi-Reader/Writer use	6-70

6-1 Operation Modes

The Reader/Writer has two operation modes: Run Mode and Safe Mode. You can use the control signal on pin 2 of the power supply connector to the Reader/Writer to change between these modes.

6-1-1 Run Mode

If you connect the control signal (pin 2, white wire) on the power supply connector on the Reader/Writer to the 24-VDC (positive) side of the power supply and turn ON the power supply, the Reader/Writer will start in Run Mode. Operation is performed as specified in the commands from the host device and the results are returned to the host device as responses.

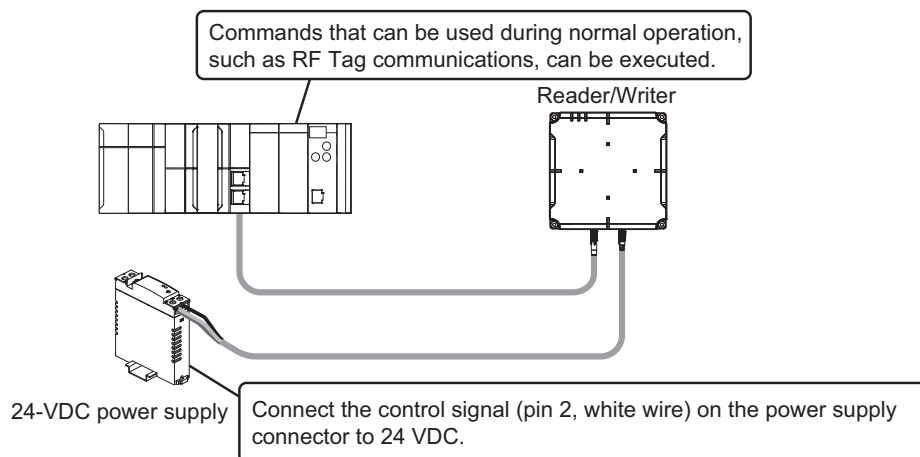

Precautions for Correct Use

Communication is performed only via the master reader/writer when the slave reader/writer (V780-HMD68-ETN-□□-S) starts in RUN mode. It can not be controlled from a host device such as PLC. But web server function is available.

6-1-2 Safe Mode

If you connect the control signal (pin 2, white wire) on the power supply connector on the Reader/Writer to the 0-VDC (negative) side of the power supply and turn ON the power supply, the Reader/Writer will start in Safe Mode. The Safe Mode is used when you do not remember the IP address that is set in the Reader/Writer. In Safe Mode, the Reader/Writer will start with the following IP settings.

IP address: 192.168.1.200
Subnet mask: 255.255.255.0

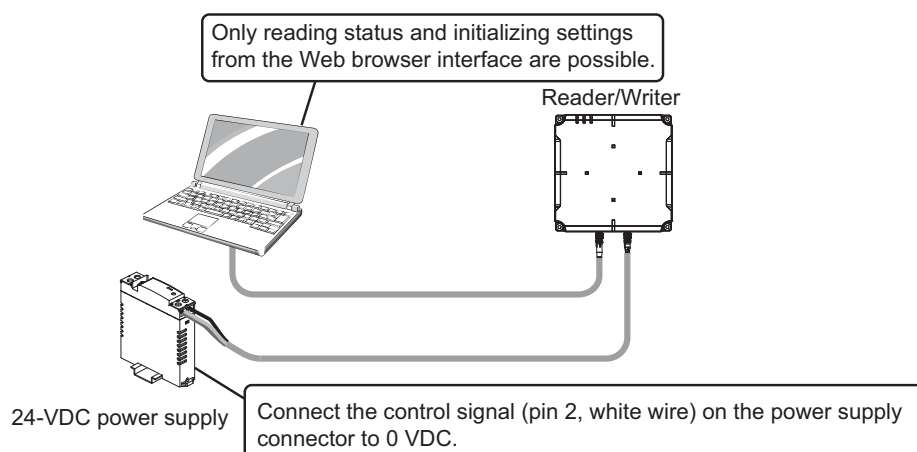

6-2 RF Tag Communications

This section describes communications between the Reader/Writer and RF Tags. The operation sequence for communications with RF Tags, response timing, and other factors depend on the communications command and communications mode.

6-2-1 Single-access Communications

With single-access communications, the Reader/Writer communicates with only one RF Tag in the communications range.

Commands for single-access communications return the results of communications with the first RF Tag detected in the communications range as the response.



Precautions for Correct Use

If there is more than one RF Tag in the communications range, communications may not be performed correctly.

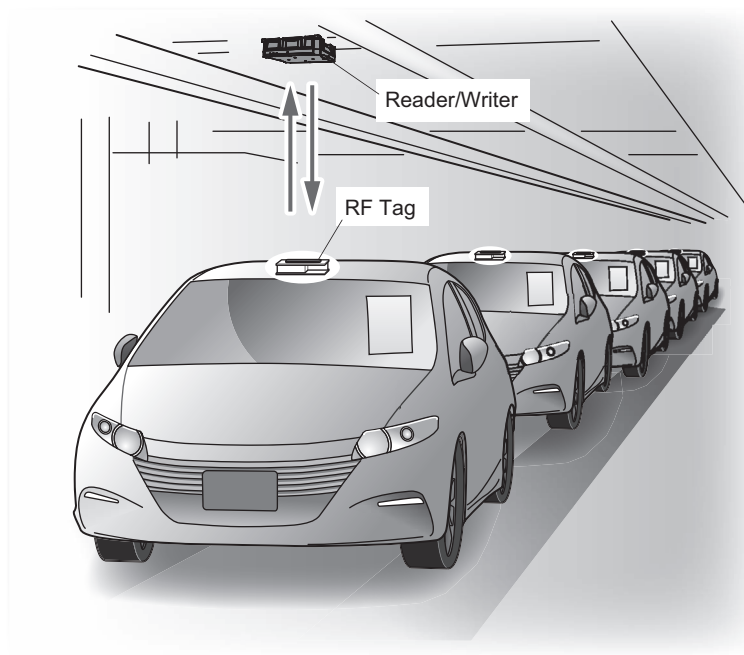

6-2-2 Multiaccess Communications

With multiaccess communications, the Reader/Writer communicates with more than one RF Tag in the communications range.

For multiaccess communications, the results of communications with all RF Tags in the communications range within the timeout time are returned as the response. Communications can be performed with up to 64 RF Tags with one communications command.

If writing were performed with multiaccess communications, it would not be possible to know which RF Tag was written to, so multiaccess writing is not supported.

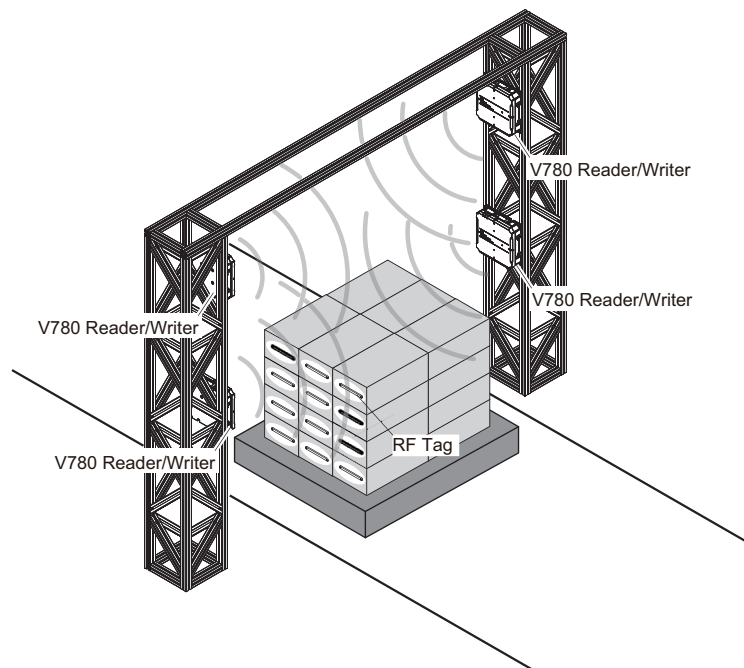
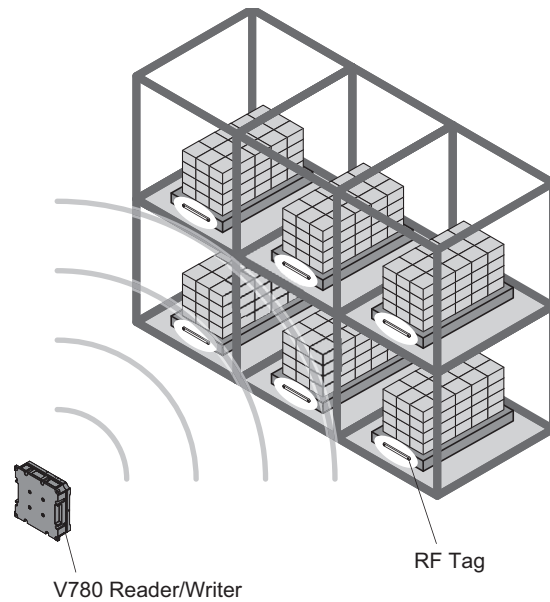

6-2-3 RF Communications Modes

The processing of communications with RF Tags depends on the RF communications mode that is specified in the Reader/Writer.

The setting of the communications mode is effective immediately after it is changed. It is saved in internal memory in the Reader/Writer even after the power supply is turned OFF.

Name	Single-access	Multiaccess	Description
Once	Supported	Supported	The Reader/Writer communicates with RF Tags when a command from the host device is executed.
Auto	Supported	Supported	When the Reader/Writer receives a command from the host device, the Reader/Writer waits, automatically detects an RF Tag entering the communications range, and communicates with it.
Focus	Supported	Not supported	The Reader/Writer constantly monitors RF Tags that enter the communications range. When it receives a command from the host device, it automatically determines which RF Tag in the communications range is in front of the Reader/Writer and communicates with that RF Tag.

Once

The Reader/Writer communicates with an RF Tag when it receives a command from the host device.

When the Reader/Writer is finished communicating with the RF Tag, it returns the communications results to the host device and waits for another command.

If there is no RF Tag in the communications range when the Reader/Writer executes the command, an RF Tag missing error will occur. It is therefore necessary to use a sensor or other device to detect the presence of an RF Tag before a command is executed.

● Single-access Operation

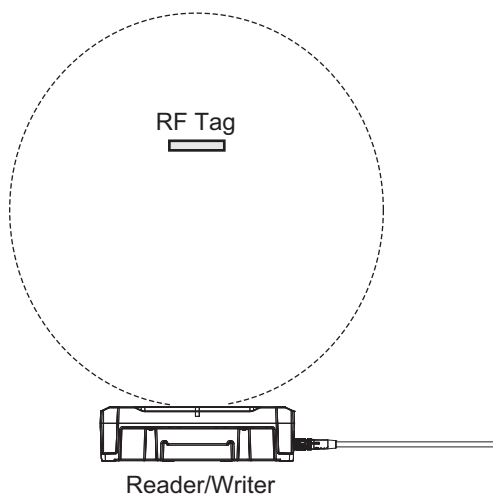

- If RF Tag exist in the communications range and communications with the RF Tag succeeds
After detection of the RF Tag, when the communication with the RF Tag is completed, the Reader/Writer returns the communication result without waiting for the timeout.

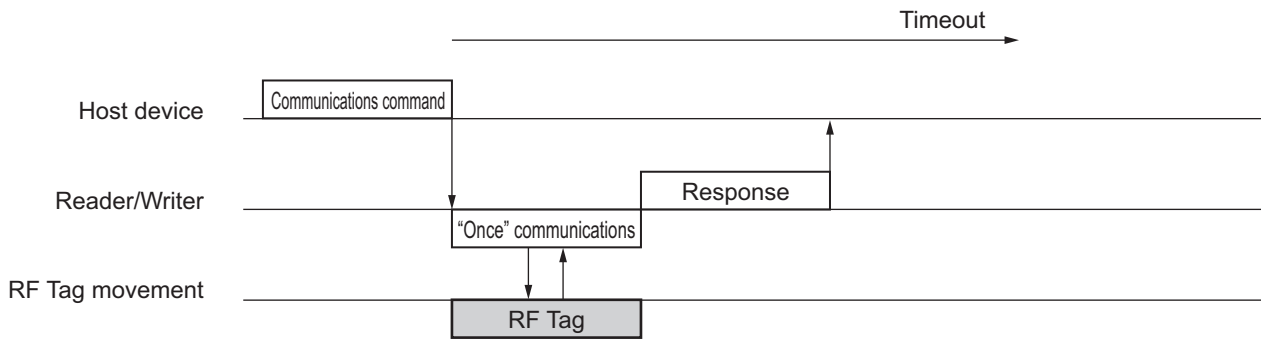

- If RF Tag exist in the communications range and communications with the RF Tag fails
After detection of the RF Tag, when the communication with the RF Tag is failed, the Reader/Writer repeats communication until the timeout even. If the Reader/Writer cannot complete communications within the timeout time, the communications results (“RF Tag communications failed”) will be returned.

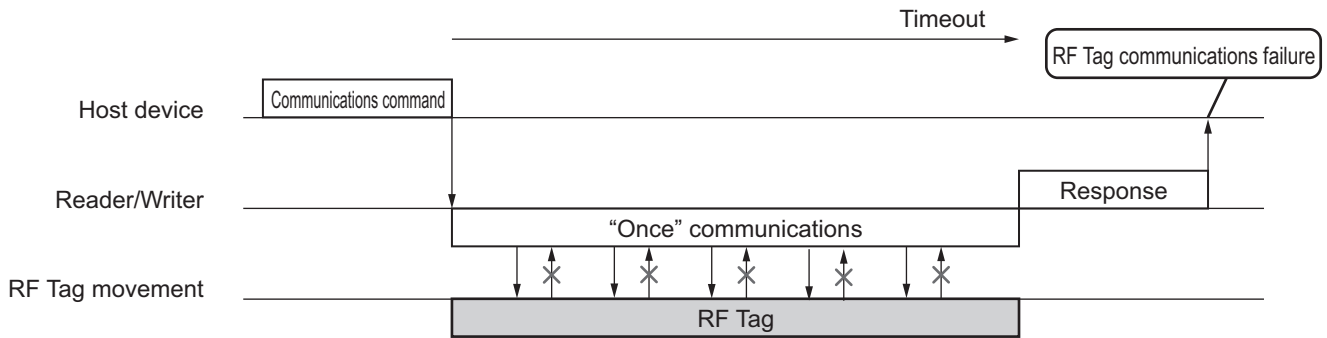

 **Additional Information**

The behavior of the RF Tag that has communicated once with the Reader/Writer depends on the **Gen2 session** setting in the advanced RF communications settings. For details, refer to *Gen2 Session* on page 6-27.

- No RF Tag in the Communications Range
When the Reader/Writer cannot detect the RF Tag, repeats detect an RF Tag until the timeout even. If the Reader/Writer cannot detect the RF Tag within the timeout time, the communications results (“RF Tag missing error”) will be returned.

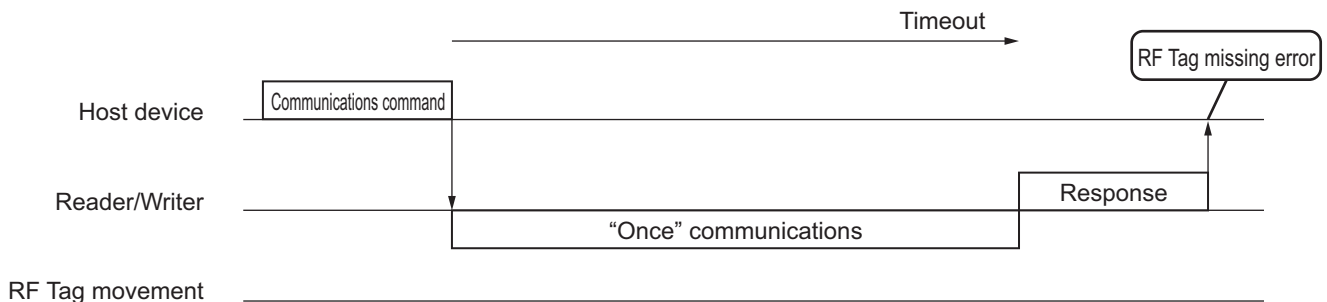

● Multiaccess Operation

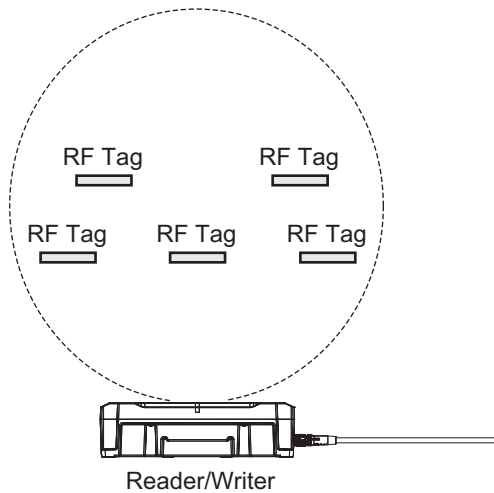

- One or More RF Tags in the Communications Range

If the Reader/Writer detects more than one RF Tag within the timeout time, it waits for the timeout and then returns the communications results. Communications results are not returned for RF Tags that could not be communicated with within the timeout time.

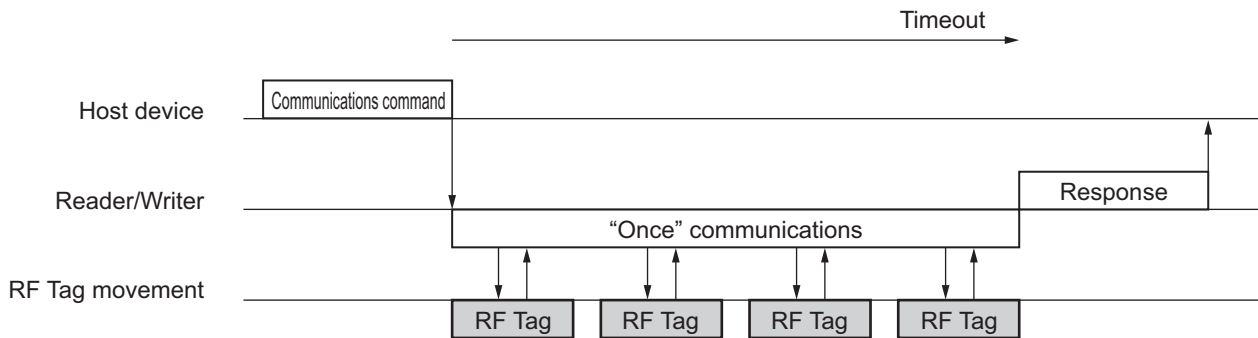

Additional Information

The behavior of the RF Tag that has communicated once with the Reader/Writer depends on the **Gen2 session** setting in the advanced RF communications settings. For details, refer to *Gen2 Session* on page 6-27.

- No RF Tag in the Communications Range

When the Reader/Writer does not detect an RF Tag in the communications range, it waits for a timeout and then returns the communications results (RF Tag missing error).

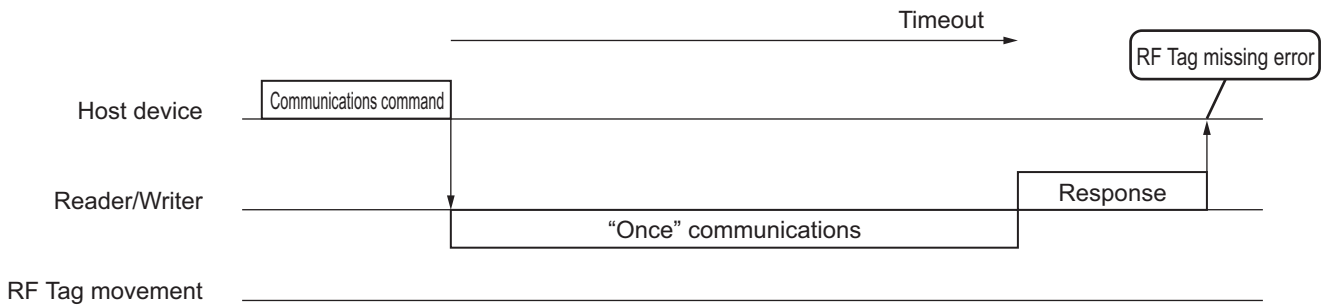

Auto

When the Reader/Writer receives a command from the host device, it automatically detects RF Tags in the communications range and communicates with them.

When the Reader/Writer is finished communicating with the RF Tag, it sends the response to the host device and waits for another command. With auto communications, the Reader/Writer automatically detects RF Tags, so a sensor or other device to detect RF Tags is not necessary. Also, auto communications will continue indefinitely until a command to stop communications is received from the host device.

● Single-access Operation

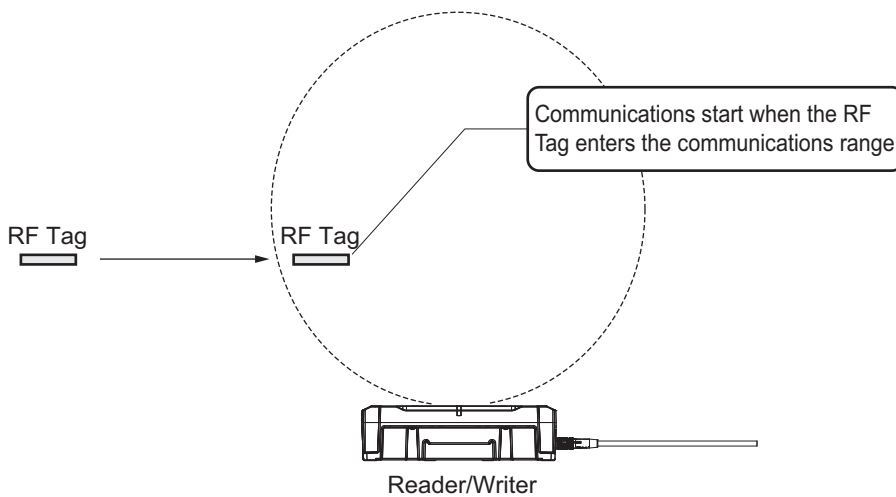

The Reader/Writer waits for an RF Tag to enter the communications range and returns the communications results after it detects an RF Tag. If there is already an RF Tag in the communications range when the command is executed, the Reader/Writer communicates with the RF Tag.

The timeout setting is disabled for single-access communications.

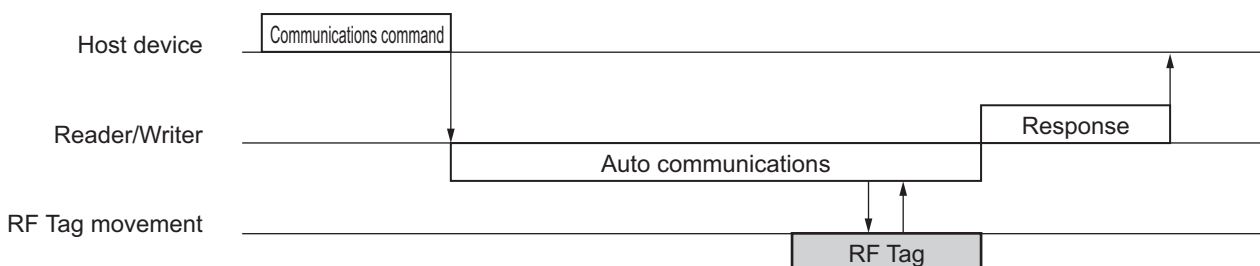



Additional Information

The behavior of the RF Tag that has communicated once with the Reader/Writer depends on the **Gen2 session** setting in the advanced RF communications settings. For details, refer to *Gen2 Session* on page 6-27.

● Multiaccess Operation

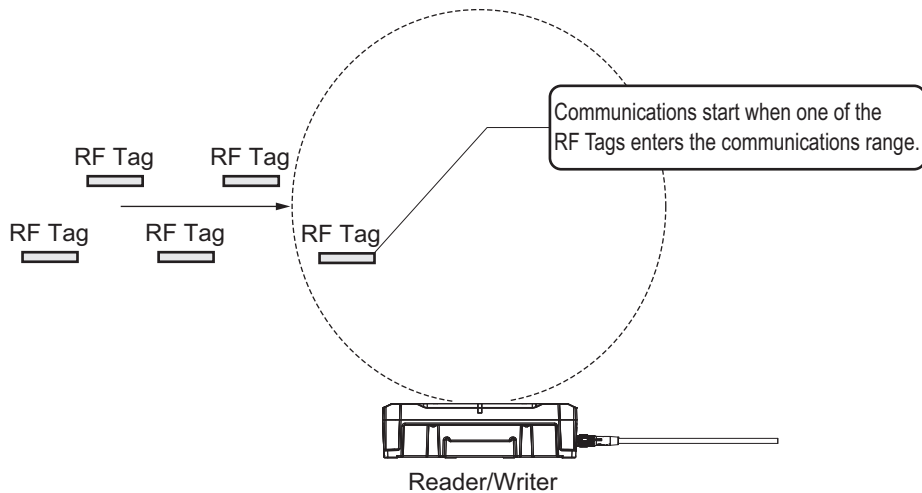

After the command from the host device is executed, the Reader/Writer automatically detects any RF Tags that enter the communications range and starts communications when even one RF Tag is detected. If the Reader/Writer then detects more RF Tags within the timeout time, it waits for the timeout and then returns the communications results. Communications results are not returned for RF Tags that could not be communicated with within the timeout time.

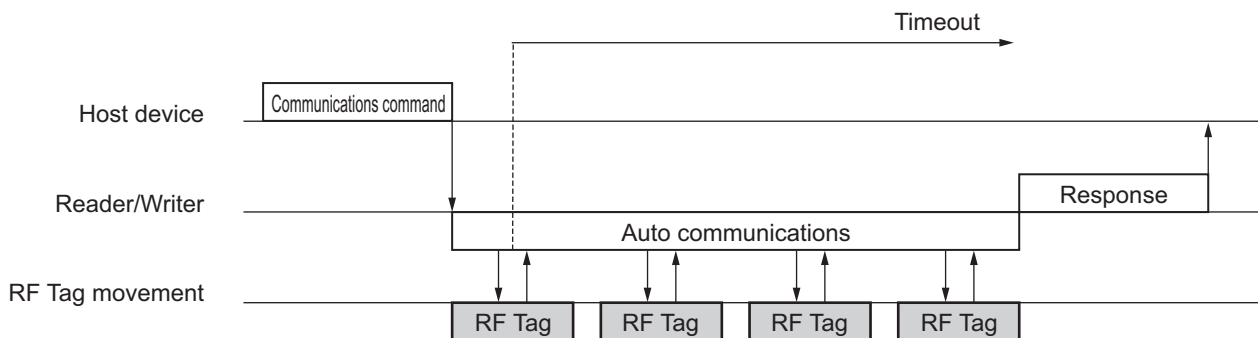

Additional Information

The behavior of the RF Tag that has communicated once with the Reader/Writer depends on the **Gen2 session** setting in the advanced RF communications settings. For details, refer to *Gen2 Session* on page 6-27.

Focus

Use Focus Mode to differentially communicate with the RF Tag that is just in front of the Reader/Writer.

When the Reader/Writer is in operation in Focus Mode, it constantly monitors RF Tags in the communications range. When the Reader/Writer receives a command from the host device, it automatically selects, from all of the monitored RF Tags, the RF Tag that is in front of the Reader/Writer (the target RF Tag) and communicates with it. Even if there are RF Tags that are not to be read in the communications range (non-target RF Tags), the Reader/Writer communicates only with the target RF Tag in front of the Reader/Writer.

You can use Focus Mode to help prevent reading non-target RF Tags or to help prevent missing the target RF Tag due to reading non-target RF Tags.

It is necessary to use a sensor or other device to confirm that the target RF Tag is in front of the Reader/Writer before the command is executed.



Precautions for Correct Use

When the Reader/Writer is in operation in Focus Mode, it calculates the target levels for the RF Tags in the communications range. When the command from the host device is executed, the Reader/Writer selects the target RF Tag with the highest target level. The selected RF Tag is identified as already being processed and the Reader/Writer will not communicate with it again until it leaves the communications range. If the RF Tag enters the communications range again, communications are again enabled with it as a selection candidate. (The “processed” status is cleared when the target level drops to 0 or lower.)

If there is only one RF Tag in the communications range when the command is executed, that RF Tag will be selected as the target RF Tag. However, any RF Tag that was previously communicated with and is identified as having already been processed will not be selected as the target RF Tag.

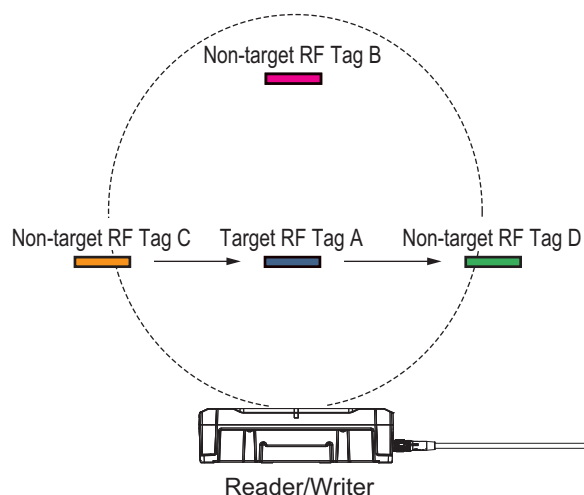

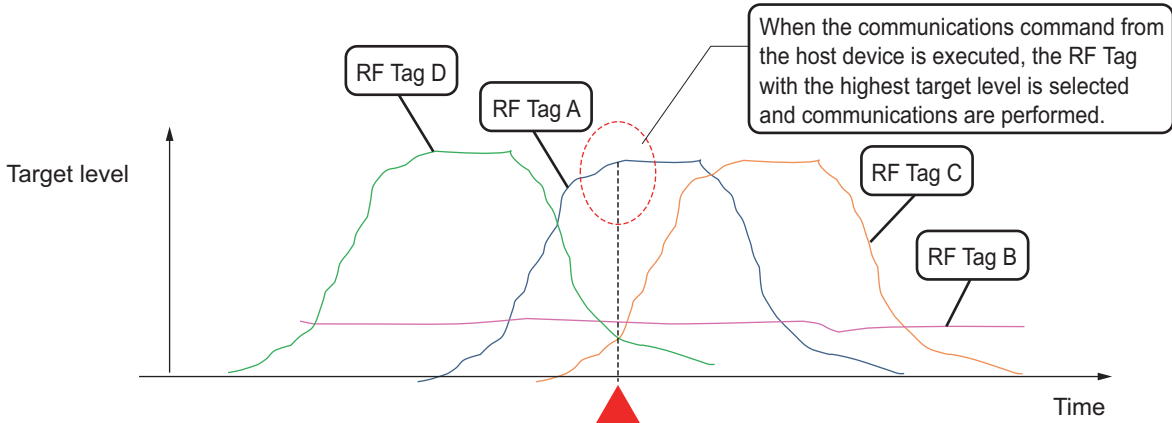

• One or More RF Tags in the Communications Range

After the Reader/Writer selects an RF Tag in the communications range, it returns the response without waiting for a timeout.

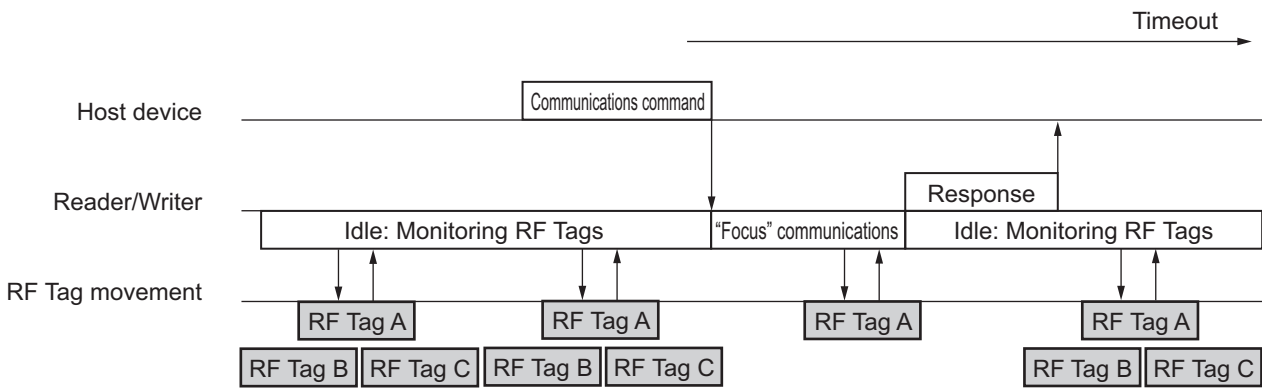

Additional Information

The behavior of the RF Tag that has communicated once with the Reader/Writer depends on the **Gen2 session** setting in the advanced RF communications settings. For details, refer to *Gen2 Session* on page 6-27.

• No RF Tag in the Communications Range

When the Reader/Writer does not detect a target RF Tag in the communications range, it waits for a timeout and then returns the communications results (RF Tag missing error).

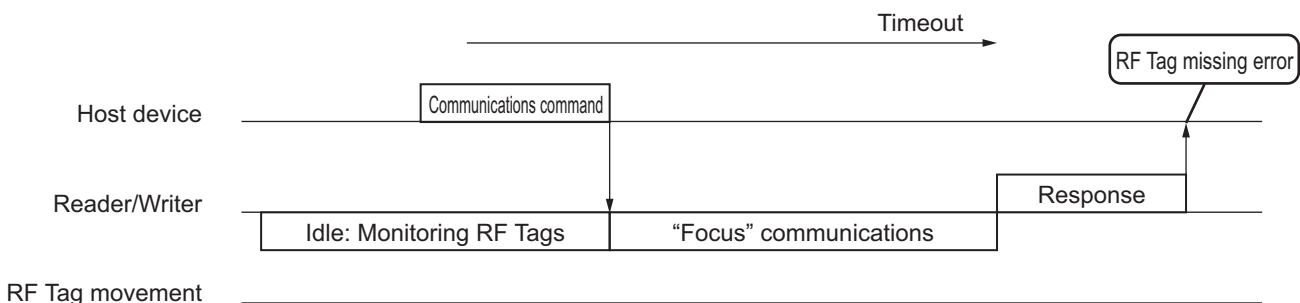

6-2-4 Communications Commands

The following table lists the communications commands. Depending on the communications command specified by the host device, single-access or multiaccess communications are performed with RF Tags.

Command name	Access method	Description
DATA READ	Single-access	Reads data from the memory of the RF Tag in the communications range.
DATA WRITE	Single-access	Writes data to the memory of the RF Tag in the communications range.
ID READ	Single-access	Reads the UII (EPC code) of the RF Tag in the communications range.
ID WRITE	Single-access	Writes the UII (EPC code) of the RF Tag in the communications range.
LOCK	Single-access	Locks the memory of the RF Tag in the communications range.
DATA FILL	Single-access	Writes the specified data to the specified number of words beginning from the specified write start address. The specifications are made in the command.
MULTIACCESS ID READ	Multiaccess	Reads the UIIs (EPC codes) of multiple RF Tags in the communications range.
MULTIACCESS DATA READ	Multiaccess	Reads data from the memory of multiple RF Tags in the communications range.



Precautions for Correct Use

Communications may not be performed correctly for single-access communications commands if there is more than one RF Tag in the communications range of the Reader/Writer. Use multiaccess communications commands to communicate with more than one RF Tag.

RF Tag Access Range

UHF-band RFID RF Tags (compliant with EPC Global Class 1 Generation 2 standards) have four memory banks with independent offset addresses. For Reader/Writer communications commands, you combine the memory bank and offset address to specify the following addresses. All addresses from the Reader/Writer to access data in an RF Tag are given in words (2 bytes each).

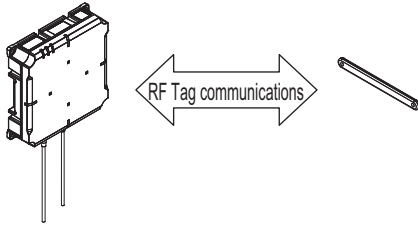

Reader/Writer command addresses (words)	RF Tag memory map		RF Tag memory area name
	Memory bank	Offset addresses (words)	
0000 hex ⋮ 07FF hex	Bank00	0000 hex ⋮ 07FF hex	Reserved (password and spare area)
1000 hex ⋮ 17FF hex	Bank01	0000 hex ⋮ 07FF hex	UII (EPC) area
2000 hex ⋮ 27FF hex	Bank10	0000 hex ⋮ 07FF hex	TID area
3000 hex ⋮ 3FFF hex	Bank11	0000 hex ⋮ 0FFF hex	User area

Command	Reserved area	UII (EPC) area	TID area	User area	Remarks
DATA READ	Supported	Supported	Supported	Supported	
DATA WRITE	Supported	Supported	Supported	Supported	
ID READ	Not supported	Restricted	Not supported	Not supported	Access is possible only to the StoredPC/UII (EPC) field in the UII (EPC) area.
ID WRITE	Not supported	Restricted	Not supported	Not supported	
LOCK	Supported	Supported	Supported	Supported	
DATA FILL	Supported	Supported	Supported	Supported	
MULTIACCESS ID READ	Not supported	Restricted	Not supported	Not supported	Access is possible only to the StoredPC/UII (EPC) field in the UII (EPC) area.
MULTIACCESS DATA READ	Supported	Supported	Supported	Supported	

Supported: All data can be accessed or locked, Restricted: Only specific parts can be accessed, Not supported: No data can be accessed.



Additional Information

Refer to A-3 *RF Tag Memory Map* on page A-17 for a detailed RF Tag memory map.

DATA READ

This command reads data from the memory of an RF Tag in the communications range.

- Specify the read start address and read size to specify the range to read.
- You can read up to 2,048 words (4 Kbytes) from each RF Tag memory bank.
- You cannot read data from more than one RF Tag memory bank at the same time.
- The actual address range that you can read from depends on the type of RF Tag that you use.
- With one command, you can read up to 120 words for the normal command and up to 2,048 words for the extended command.
- The following table shows the communications modes that you can specify for DATA READ.

Once	Auto	Focus	Remarks
Supported	Supported	Supported	

Supported: Can be specified, Not supported: Cannot be specified.

DATA WRITE

This command writes data to the memory of the RF Tag in the communications range.

- Specify the write start address and write size to specify the range to write.
- You can write up to 2,048 words (4 Kbytes) from each RF Tag memory bank.
- You cannot write data to more than one RF Tag memory bank at the same time.
- The actual address range that you can write to depends on the type of RF Tag that you use.
- With one command, you can write up to 120 words for the normal command and up to 2,048 words for the extended command.
- The following table shows the communications modes that you can specify for DATA WRITE.

Once	Auto	Focus	Remarks
Supported	Supported	Supported	

Supported: Can be specified, Not supported: Cannot be specified.

ID READ

This command reads the PC and UIIs (EPC codes) of the RF Tag in the communications range.

- The following data is read and is always 32 words: StoredPC field (1 word) and UII (EPC) field (31 words).
- The following table shows the communications modes that you can specify for ID READ.

Once	Auto	Focus	Remarks
Supported	Supported	Supported	

Supported: Can be specified, Not supported: Cannot be specified.

ID WRITE

This command writes the UII (EPC code) of the RF Tag in the communications range.

- The code to write to the UII (EPC) field is specified with the write size and write data (1 to 31 words).
- The value specified for the write size is written as the UII (EPC) length in the StoredPC field.
- The following table shows the communications modes that you can specify for ID WRITE.

Once	Auto	Focus	Remarks
Supported	Supported	Supported	

Supported: Can be specified, Not supported: Cannot be specified.

LOCK

This command locks the memory of the RF Tag in the communications range.

Use this command to write-protect the data in an RF Tag.

- Specify locking or unlocking for the lock operation.
- You can specify the UII (EPC) area, TID area, user area, or access password area as the area to lock or unlock.
- When an area is locked, the specified access password is written to the access password area in the RF Tag.
- A locked UII (EPC) area, TID area, or user area cannot be written to without specifying the access password.
- A locked access password area cannot be read or written to without specifying the access password.
- To unlock an area, the access password stored in the RF Tag must be specified.
- The following table shows the communications modes that you can specify for LOCK.

Once	Auto	Focus	Remarks
Supported	Supported	Supported	

Supported: Can be specified, Not supported: Cannot be specified.

DATA FILL

This command writes the specified data to the specified number of words beginning from the specified write start address. The specifications are made in the command.

- The range to write is specified with the fill start address and fill size (2,048 words max.).
- The fill data specifies the value to write (2 bytes).
- If 0 is specified for the fill size, the entire memory bank is written.
- You cannot write data to more than one RF Tag memory bank at the same time.
- The actual address range that you can initialize depends on the type of RF Tag that you use.
- The following table shows the communications modes that you can specify for DATA FILL.

Once	Auto	Focus	Remarks
Supported	Supported	Supported	

Supported: Can be specified, Not supported: Cannot be specified.

MULTIACCESS ID READ

This command reads the UIIs (EPC codes) of multiple RF Tags in the communications range.

- The following data is read and is always 32 words: StoredPC field (1 word) and UII (EPC) field (31 words).
- The following table shows the communications modes that you can specify for MULTIACCESS ID READ.

Once	Auto	Focus	Remarks
Supported	Supported	Not supported	

Supported: Can be specified, Not supported: Cannot be specified.

MULTIACCESS DATA READ

This command reads data from the memory of multiple RF Tags in the communications range.

- Specify the read start address and read size to specify the range to read.
- You can read up to 2,048 words (4 Kbytes) from each RF Tag memory bank.
- You cannot read data from more than one RF Tag memory bank at the same time.
- The actual address range that you can read from depends on the type of RF Tag that you use.
- You can read up to 32 words with one command.
- The following table shows the communications modes that you can specify for MULTIACCESS DATA READ.

Once	Auto	Focus	Remarks
Supported	Supported	Not supported	

Supported: Can be specified, Not supported: Cannot be specified.

Communications Commands and Error Codes

The errors that can occur for each communications command are given in the following table.

Command name	RF Tag missing error (2001 hex)	RF Tag communications failure (2002 hex)	RF Tag address error (2004 hex)	RF Tag lock error (2005 hex)	RF Tag Verification error (2006 hex)	RF Tag system error (2008 hex)	Password error (2009 hex)
DATA READ	Supported	Supported	Supported	Supported	Not supported	Supported	Supported
DATA WRITE	Supported	Supported	Supported	Supported	Supported	Supported	Supported
ID READ	Supported	Supported	Not supported	Not supported	Not supported	Supported	Not supported
ID WRITE	Supported	Supported	Not supported	Supported	Supported	Supported	Supported
LOCK	Supported	Supported	Not supported	Supported	Not supported	Supported	Supported
DATA FILL	Supported	Supported	Supported	Supported	Supported	Supported	Supported
MULTIACCESS ID READ	Supported	Supported	Not supported	Not supported	Not supported	Supported	Not supported
MULTIACCESS DATA READ	Supported	Supported	Supported	Supported	Not supported	Supported	Supported

Supported: Can occur, Not supported: Will not occur.

6-3 Reader/Writer Controls

This section describes the control functions of the Reader/Writer.

6-3-1 Initialization

You can return all of the settings in the Reader/Writer to the default settings with the INITIALIZE command or the Configuration Button on the Web browser interface.

6-3-2 Resetting

You can restart the Reader/Writer with the RESET command or with the **Reboot** Button on the Web browser interface. Restart the Reader/Writer when you change the network settings or any other settings that require restarting to be enabled. When the Reader/Writer acknowledges the reset request, it will return a response and then automatically restart itself.

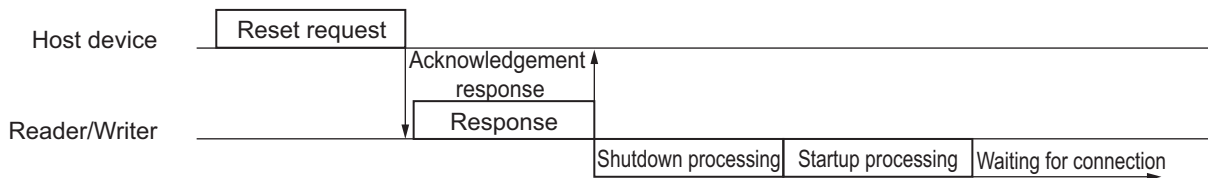

Normal Reset

When a command from the Reader/Writer is received, if the Reader/Writer operating status is other than "RF Tag communications in progress, Changing settings", it will automatically restart itself.

- **Application:**

When reflecting user settings, switching operation modes, etc.

Forced Reset

When a command from the Reader/Writer is received, restart itself processing is performed regardless of the Reader/Writer operating status.

- **Application:**

Recovery when the Reader/Writer falls into an uncontrollable state, etc.

6-3-3 Stopping

You can use the STOP command to stop the command operation of the Reader/Writer during execution.

When the Reader/Writer acknowledges the STOP command, it will return a response and then stop the current command operation.

● Stopping Command Operation before RF Tag Detection

If the Reader/Writer receives a command to stop operation before it detects an RF Tag, a “communications canceled” communications result is returned.

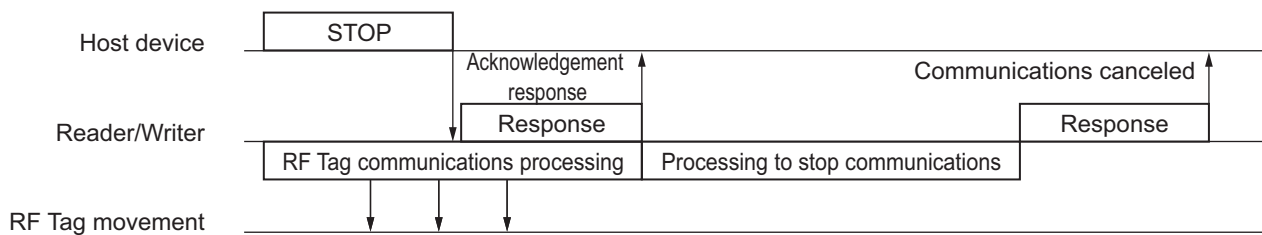

● Stopping Command Operation after RF Tag Detection

If the Reader/Writer receives a command to stop operation after it detects an RF Tag, a “communications aborted” communications result is returned. (For a DATA WRITE command, the contents of the RF Tag may have been changed.)

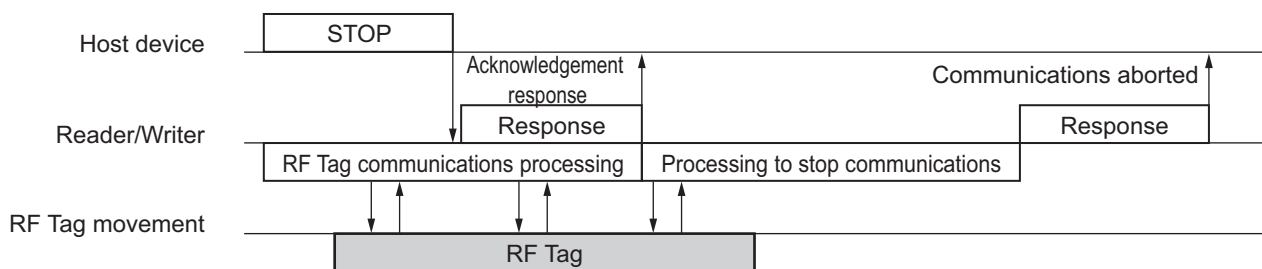

6-3-4 RESET FOCUS

You can use a RESET FOCUS command to clear the target level information in the Reader/Writer for all monitored RF Tags during operation in Focus Mode.

After the Reader/Writer completes reception of the RESET FOCUS command, it returns a response, clears the information, and then starts monitoring for RF Tags again.

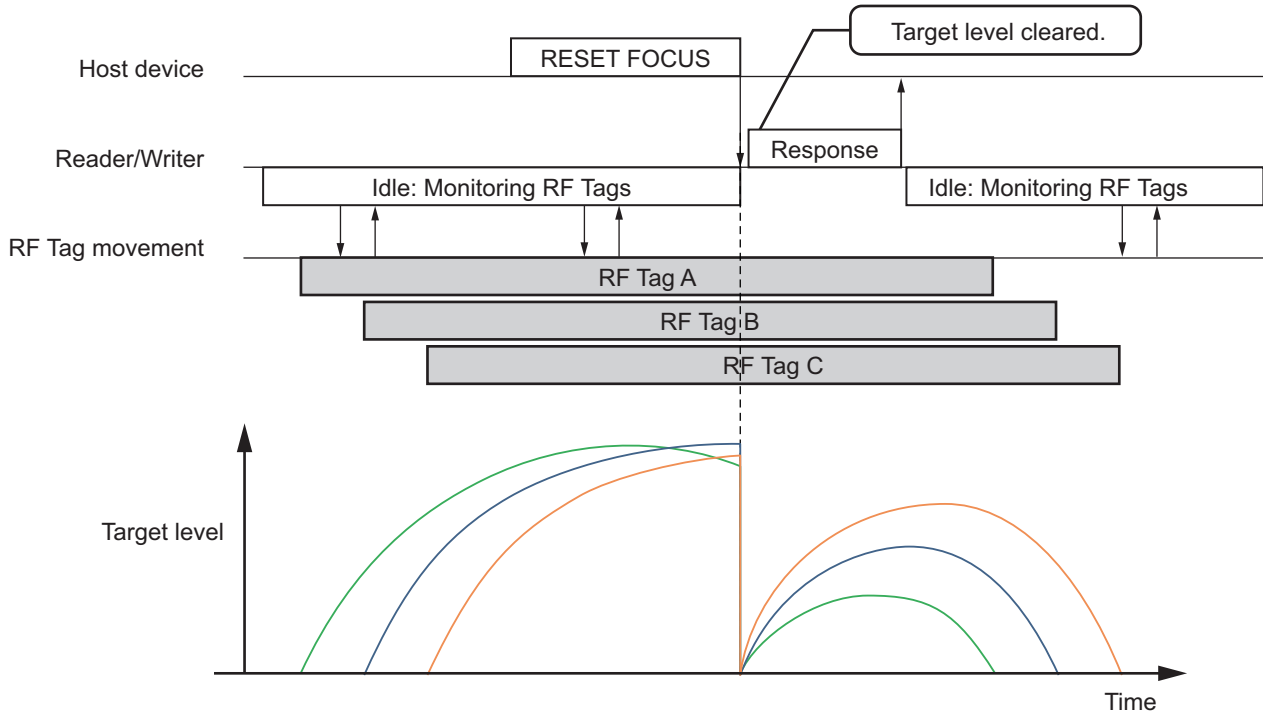

6-3-5 Installation Location Notification

Outline

You can use the operation indicators to find the installation location of a Reader/Writer.

When there is more than one Reader/Writer installed onsite, you can identify the Reader/Writer that is being manipulated from the Web browser interface.

Notification Method

You can flash the NORM/ERR indicators on a Reader/Writer by clicking the **Flash the LED** Button on the TCP/IP Settings Tab Page in the Network Settings View of the Web browser interface. The NORM/ERR indicators will flash cyan at a 0.1-s interval for 3 s.

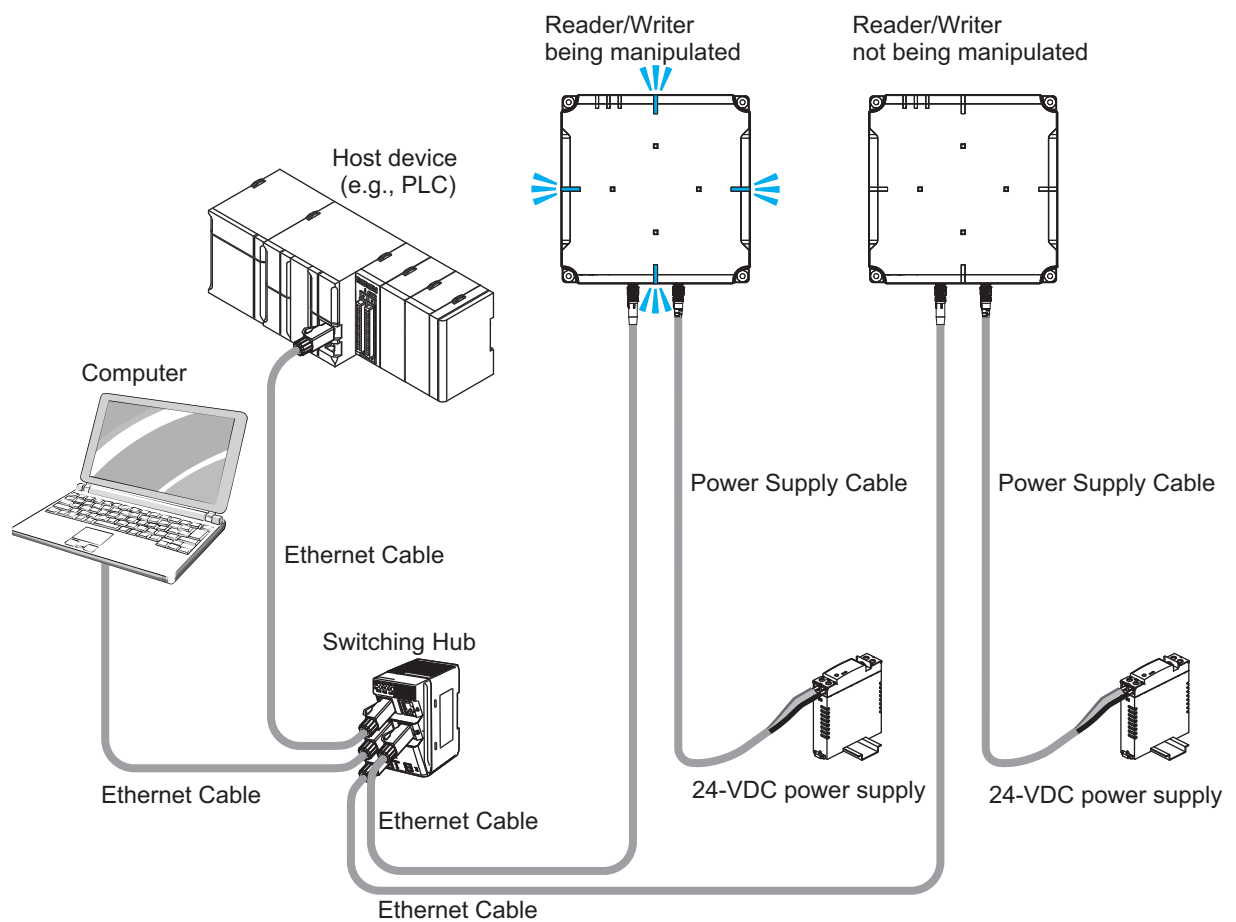

6-4 Reader/Writer Settings

You can use a setting command or a Web browser to set the operating conditions of the Reader/Writer according to the application environment. These settings are stored in non-volatile memory inside the Reader/Writer, so they are retained when the power supply to the Reader/Writer is turned OFF.

Setting classification	Description	Remarks
Network settings	You can set parameters related to the Ethernet interface on the Reader/Writer.	The Reader/Writer must be restarted to enable changes to these settings.
RF communications conditions: Basic Settings	You can set basic parameters for the operation of Reader/Writer communications with RF Tags.	Any changes to these settings are enabled immediately.
RF communications conditions: Advanced settings	You can set advanced parameters for the operation of Reader/Writer communications with RF Tags.	
Device settings	You can set parameters related to the operation of the Reader/Writer.	The Reader/Writer must be restarted to enable changes to these settings.

6-4-1 Network Settings

TCP/IP Settings

You can set a fixed IP address for the Reader/Writer or you can specify obtaining an IP address from a BOOTP server.



Precautions for Correct Use

If you change the IP address setting method from Fixed setting to Obtain from BOOTP server or Fix at the IP address which is obtained from BOOTP server, the IP address, subnet mask, and default gateway that are set for Fixed setting become 0. If necessary, perform a backup in advance.

Setting item	Description	Default
IP address setting method	<ul style="list-style-type: none"> Fixed setting Obtain from BOOTP server^{*1} Fix at the IP address which is obtained from BOOTP server^{*2} 	Fixed setting
IP address	Fixed IP address	192.168.1.200
Subnet mask	The subnet mask is a value (IPv4) that is used to identify the network address and host address within the IP address.	255.255.255.0
Default gateway address	The IP address of the gateway to use to reach networks outside the one that the Reader/Writer is on.	192.168.1.254
Device name	A name that is used to identify the Reader/Writer on the network. It consists of up to 63 ASCII characters.	(Not set.)

*1. If you specify *Obtain from BOOTP server* for the IP address setting method, the Reader/Writer will ask the BOOTP server for an IP address setting every time it is started.

*2. If you specify *Fix at the IP address which is obtained from BOOTP server* for the IP address setting method, the Reader/Writer will ask the BOOTP server for an IP address setting only the first time that it is started after the setting was made. Thereafter, it will operate with a fixed IP address setting.

Port Settings

Setting item	Description	Default
Modbus/TCP port	The logical port number to use for Modbus/TCP communications with the host device.	502* ¹

*1. The slave reader/writer (V780-HMD68-ETN-□□-S) can not change the Modbus/TCP port number from the default.

Web Password Setting

Setting	Description	Default
All zeros	No login password is set for the Web browser interface if the setting is all zeros.	All zeros
Not all zeros (any value)	Anything other than all zeros is treated as the password. The password can be up to 15 ASCII characters.	

6-4-2 RF Communications Conditions: Basic Settings

RF Communications Mode

You can select the communications mode to specify the operation of communications with RF Tags according to your environment or application.

Setting	Description	Default
Once	The Reader/Writer communicates with RF Tags when a command from the host device is executed.	Once
Auto	When the Reader/Writer receives a command from the host device, it automatically detects RF Tags in the antenna communications range and communicates with them.	
Focus	The Reader/Writer constantly monitors for RF Tags, focuses on one RF Tag in the antenna communications range, and diagnoses communications. When the Reader/Writer receives a command from the host device, it determines which RF Tag is in front of the Reader/Writer and communicates with it. Use Focus Mode to help prevent failure to read target RF Tags or reading unnecessary RF Tags.	

RF Communications Speed

The RF communications speed setting can be used to change the speed of communications with RF Tags. You can thereby select whether to give priority to the communications time or to communications stability.

Setting	Description	Default
Auto speed	The Reader/Writer determines the communications speed for RF Tags based on interference conditions.	Auto speed
High speed	The communications speed for RF Tags is increased to reduce the communications time. However, this will make communications more susceptible to interference, such as from ambient noise.	
Normal speed	The communications speed for RF Tags is decreased to increase the stability of the communications quality. More time will be required for communications, but there will be more resistance to interferences, such as from ambient noise.	

RF Communications Timeout Time

The RF communications timeout time lets you specify an upper limit to the time required to process single-access or multiaccess communications. You can use this to provide leeway for details in detecting RF Tags in the communications range or to adjust the timing of when responses are returned.

Setting item	Description	Default
Timeout time	1 to 60,000 ms (in 1-ms increments)	250 ms

The RF communications timeout time is measured from when the Reader/Writer starts executing a communications command until an RF Tag is detected. If an RF Tag is not detected before the timeout time expires, an RF Tag missing error response is returned. If an RF Tag has already been detected when the timeout time expires, communications with that RF Tag are completed. (Communications after RF Tag detection will not be aborted for a timeout.)

Write Verification

The write verify setting can be used to automatically check the accuracy of written data for any communications command that writes data to an RF Tag.

Setting	Description	Default
Selected	After data is written to an RF Tag, the data is read to verify that the correct data was written. *1	Selected
Not selected	Verification is not performed after data is written to an RF Tag.	

*1. If verification shows that the read data is not the same as the write data, a verification error response is returned. The written data will not be changed. Write the original data again.

RF Communications Diagnostics

When a communications command is executed, communications diagnostics are performed to diagnose how much leeway there is in RF communications.

Monitoring status during operation helps create a more stable Reader/Writer and RF Tag installation.

Setting	Description	Default
Enable	Diagnostics are performed when communicating with an RF Tag and the results are displayed on the operation indicators and sent to the host device.	Disable
Disable	Diagnostics are not performed during RF Tag communications.	

*1. If you enable communications diagnostics, the communications time will be longer than when they are disabled.

6-4-3 RF Communications Conditions: Advanced Settings

Transmission Power

You can specify the transmission power for read communications and write communications. If you adjust the transmission power according to the communications distance, you can suppress radio wave interference and reduce reading non-target RF Tags.

Setting item	Description	Default
Tx power (Read)	The transmission power output during execution of read communications commands. 15 to 27 dBm (in 1-dB increments)	27 dBm
Tx power (Write)	The transmission power output during execution of write communications commands. 15 to 27 dBm (in 1-dB increments)	27 dBm

*1. The communications distance is shorter when writing data to an RF Tag in comparison with reading data from an RF Tag. The difference in the communications distance varies depending on the RF Tag.



Precautions for Correct Use

- Due to the surrounding environment, the intended RF tag may not be readable if the transmission power output is overly strong.

Channel

You can use the channel setting to select the channel (i.e., the frequency band) to use for execution of communications commands.

Use this setting to prevent mutual interference with nearby Reader/Writers and interference with other wireless devices.

Setting	V780-HMD68-ETN-□□	Default
Auto channel	The channel is automatically switched depending on the conditions of the Reader/Writer.	Auto channel
Specified Channel*1	This specifies the channel to use.	
V780-HMD68-ETN-JP	5CH: 916.8MHz 11CH: 918.0MHz 17CH: 919.2MHz	
V780-HMD68-ETN-IN	4CH: 865.7 MHz 7CH: 866.3 MHz 10CH: 866.9 MHz	
V780-HMD68-ETN-EU	4CH: 865.7 MHz 7CH: 866.3 MHz 10CH: 866.9 MHz 13CH: 867.5 MHz	
V780-HMD68-ETN-RU	7CH: 866.3 MHz 10CH: 866.9 MHz 13CH: 867.5 MHz	

*1. The channel used can only be specified in models V780-HMD68-ETN-IN/-EU/-RU. The channel cannot be specified in the other models.



Version Information

In Ver.1.00/Ver.2.00, 916.6 MHz is used as channel number 1CH.

In Ver.3.00, the channel number was changed in accordance with the regulations of the Japanese Radio Act.

Gen2 Session

The Gen2 session setting determines the length of time to hold the status of the RF Tag. The Reader/Writer communicates with an RF Tag and then sets a flag in the RF Tag after communications to indicate that it has been processed. The timing for retaining this flag depends on the session. We recommend that you normally use the default setting of S0.

Setting	Description	Default
S0	The status of the flag is not retained after power to the RF Tag is turned OFF. Use this setting to always process communications for each command for all RF Tags that are in the communications range.	S0
S1	The status of the flag is retained for 500 ms to 5 s regardless of whether the power supply to the RF Tag is turned ON or OFF. Use this setting to process communications at a set interval for the same RF Tags when a communications command is repeatedly executed.	
S2/S3	The status of the flag is retained for at least 2 s after power to the RF Tag is turned OFF. Use either of these settings to process communications only once when each RF Tag first enters the communications range when a communications command is repeatedly executed.	



Precautions for Correct Use

If you specify a stop time in the transmission time settings and then stop the output during RF Tag communications, you cannot use session S0 for multiaccess communications. If you specify S0 anyway, results may be returned more than once for the same RF Tag. (When the output is stopped, the status in the RF Tag is reset, so the “already processed” status is cleared.)

Access Password

You must specify the access password (8 hexadecimal digits) to the Reader/Writer to execute communications commands for an RF Tag with a locked memory area. If you attempt to execute a communications command without specifying the access password, a password error will occur.

- If the access password area in the memory of the RF Tag is not all zeros, the memory will be locked.
- If the UII (EPC) area, TID area, user area, or access password area in the memory of the RF Tag is locked, you must specify the access password to use write communications commands for the locked area.
- If the access password area in the memory of the RF Tag is locked, you must specify the access password to use a communications command (DATA READ) to read the area.

Setting	Description	Default
All zeros	An access password is not set. Access password verification is not required to communicate with the RF Tag.	00000000 hex (Not set.)
Not all zeros (any value)	An access password is set. Access password verification is required to communicate with the RF Tag.	

Transmission Time

You can specify the continuous transmission time to output radio waves continuously and the stop time to pause the output when the Reader/Writer communicates with an RF Tag.

By stopping the transmission output at specific intervals, you can suppress the influence of radio wave interference with nearby Reader/Writers.

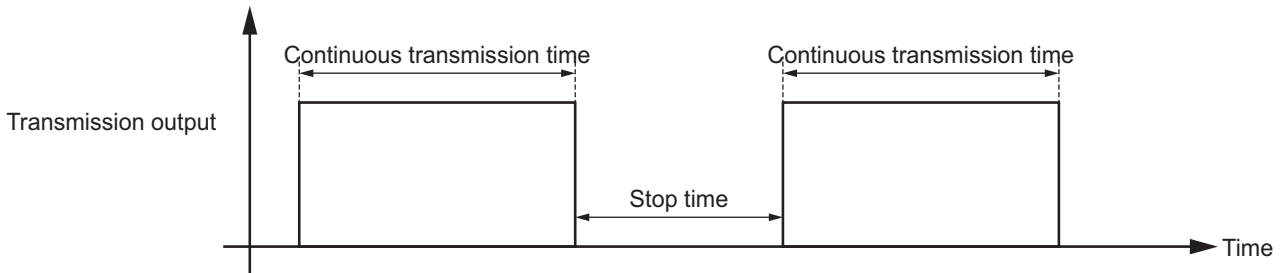

Setting	Description	Default
Continuous time	The maximum time to continuously output radio waves during communications commands execution	
V780-HMD68-ETN-JP	Infinite or 400 to 10,000 ms	Infinite
V780-HMD68-ETN-KR/-TW/-ID/-MY/-SG/-US/-MX	400 ms (Fixed)	---
V780-HMD68-ETN-CN	2,000 ms (Fixed)	---
V780-HMD68-ETN-IN/-EU/-RU	4,000 ms (Fixed)	---
Stop time	The time to pause output during communications commands execution	
V780-HMD68-ETN-JP	None or 10 to 1,000 ms	None
V780-HMD68-ETN-KR/-CN/-TW/-ID/-MY/-SG/-US/-MX	10 ms to 1,000 ms	10 ms
V780-HMD68-ETN-IN/-EU/-RU	100 ms to 1,000 ms	100 ms

RSSI Filter

The RSSI (received signal strength indicator) gives the strength level of the signal received from an RF Tag. (This is called the reception level.) If you set the reception level thresholds for the RSSI filter, communications will be performed only with RF Tags that have a reception level that is between the low and high thresholds

(Low threshold ≤ Reception level ≤ High threshold)

Use this to prevent reading non-target RF Tags.

Setting item	Description	Default
Disable	Filtering the reception level is not performed.	Disable
Enable	Filtering the reception level is performed.	
High threshold	0, or -70 to -10dBm (in 1-dB increments)	
Low threshold	0, or -70 to -10dBm (in 1-dB increments)	

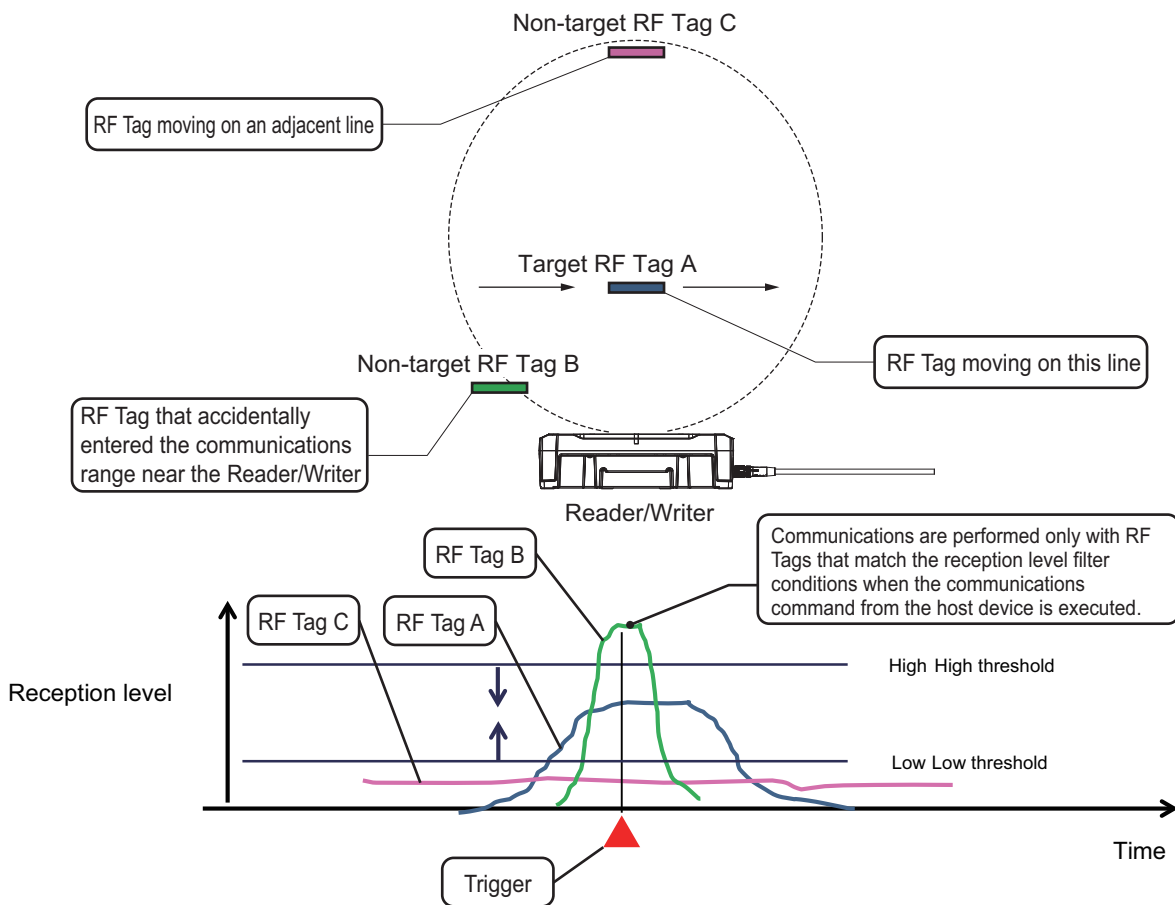

RF Tag Selection Filter

The RF Tag selection filter can be used to verify data in any memory area of the RF Tag and communicate only with RF Tags that have matching data.

By communicating only with target RF Tags, communications efficiency is increased and reading non-target RF Tags can be prevented.

Setting item	Description	Default
Disable	Filtering is not performed with RF Tag data verification.	Disable
Enable	Filtering is performed with RF Tag data verification.	
Verification data	Specify the RF Tag memory address, verification data size, and verification data pattern. * You can specify up to 16 hexadecimal words in word increments for the verification data.	

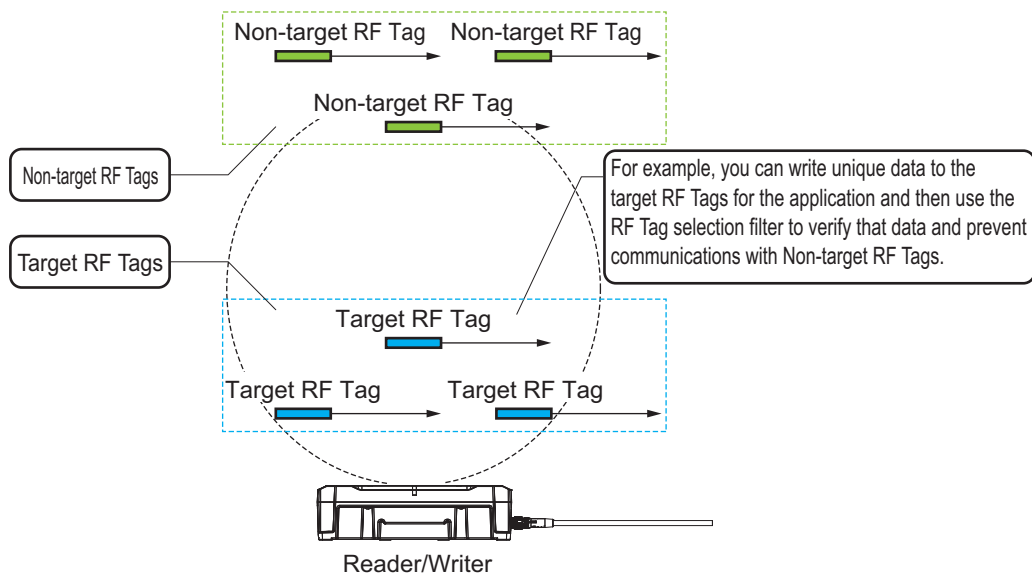

6-4-4 Device Settings

Operation Indicator Custom Settings

You can change the NORM/ERR indicator lighting pattern after Reader/Writer command execution.

You can set one of eight lighting patterns: Lit in each of seven colors and OFF.

You can change only the NORM/ERR indicator lighting pattern that appears after command execution. You cannot change the lighting pattern for minor and major faults (lit red).

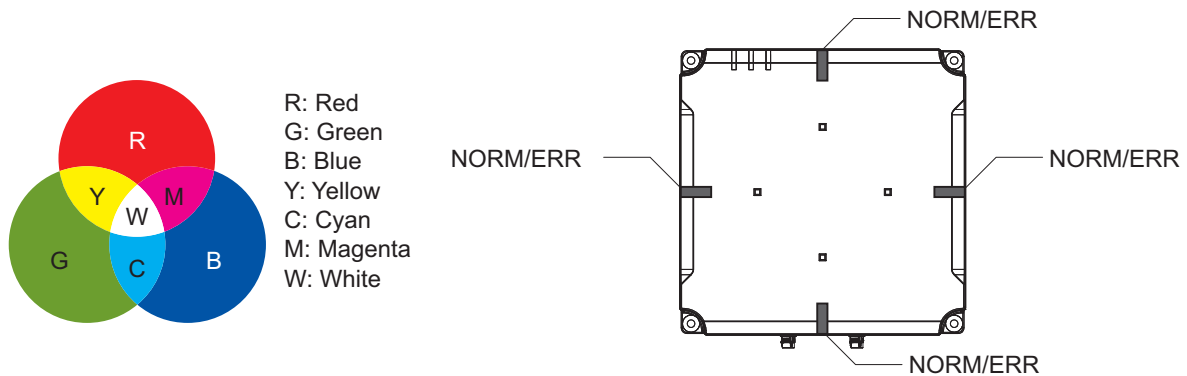

Precautions for Correct Use

The custom indicator settings are not used during test operation for tuning or utility functions performed from the Web browser interface. The indicators will light in the default colors.

Setting item	Description	Default
Command normal (NORM)	The indicators light with the specified lighting pattern when processing a communications command or another command from the host device is completed normally.	Lights green
Command error (ERROR)	The indicators light with the specified lighting pattern when processing a communications command or another command from the host device ends in an error.	Lights red
Unstable communications (WARNING)	The indicators light with the specified lighting pattern each time an unstable communication is detected while communications diagnosis is enabled.	Lights yellow

Multi-Reader/Writer Configuration Settings

It is possible to connect multiple Reader/Writers, and communicate with the RF Tags by setting the Multi-Reader/Writers.

It is possible to specify the Multi-Reader/Writer mode and a maximum of seven Reader/Writers as slave reader/writers.

The slave reader/writer (V780-HMD68-ETN-□□-S) and Reader/Writer set to SLAVE mode can not change the multi reader/writer configuration setting.

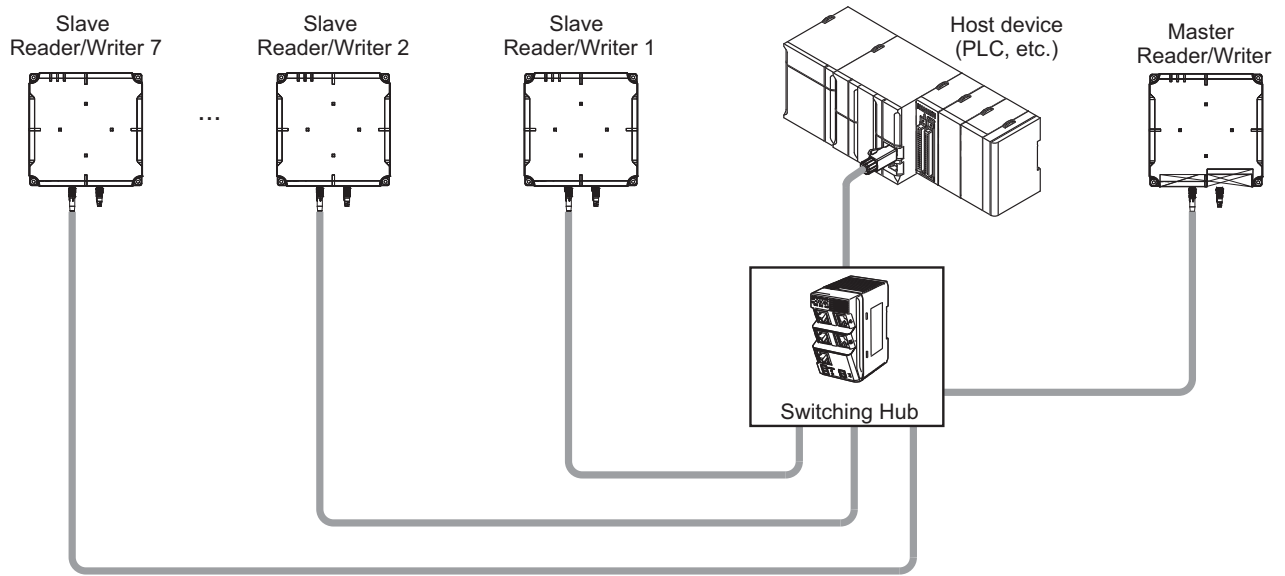

Setting item	Description	Default
Multi-Reader/Writer mode	Disabled: Communications are performed with a single Reader/Writer unit. Enabled: Communications are performed using multiple Reader/Writers.	Disable
Number of Slave Reader/Writers	This specifies the number of slave Reader/Writers.	0
Slave Reader/Writer 1 IP Address	This specifies the IP address of the Reader/Writer registered as the slave reader/writer.	0.0.0.0
Slave Reader/Writer 2 IP Address		0.0.0.0
Slave Reader/Writer 3 IP Address		0.0.0.0
Slave Reader/Writer 4 IP Address		0.0.0.0
Slave Reader/Writer 5 IP Address		0.0.0.0
Slave Reader/Writer 6 IP Address		0.0.0.0
Slave Reader/Writer 7 IP Address		0.0.0.0

6-4-5 Exporting/Important Configuration Files

From the Web browser interface, you can output a file of all Reader/Writer settings and save them on your computer (export). You can also read a configuration file and write it to the Reader/Writer from the Web browser interface (import). The configuration file is in INI file format.

The slave reader / writer (V780-HMD68-ETN-□□-S) and Reader/Writer set to SLAVE mode can not import/export “Multi reader/writer setting” and “Modbus/TCP port” of the setting file.



Additional Information

For details, refer to *Operation Indicator Custom Settings* on page 8-13.

6-5 Maintenance: Device Information

6-5-1 Reading Device Information

You can use a command or the Web browser interface to check the device information in the Reader/Writer.

Item	Description	Remarks
Model	The model number of the Reader/Writer.	
Firmware version	The firmware version in the Reader/Writer.	
MAC address	The MAC address that is assigned to the Reader/Writer.	



Additional Information

For details, refer to *8-2-2 Status* on page 8-5.

6-5-2 Getting the Operating Status

You can use a command or the Web browser interface to check the current operation mode and status of a Reader/Writer.

Item	Description	Remarks
Operation mode	The operation mode of the Reader/Writer. The operation mode is either Run Mode or Safe Mode.	
Status	The status of the Reader/Writer. The status can be idle (waiting for a command), RF communications in progress, changing settings, or system error.	



Additional Information

For details, refer to *8-2-2 Status* on page 8-5.

6-5-3 Getting and Setting Time Information

You can use a command or the Web browser interface to check or set the time information in the Reader/Writer.

The clock information is not retained when the power supply is turned OFF. Use a command to reset the clock information when you turn ON the power supply.

Item	Description	Remarks
Time information	The time information is handled in the following format: HH/MM/SS. If the time information is not set from the host device, the elapsed time from when the Reader/Writer was started will be given.	Calendar information (YY/MM/DD) is not supported. The time accuracy is ± 39 s per month.



Additional Information

For details, refer to *8-2-2 Status* on page 8-5.

6-6 Maintenance: Log Information

6-6-1 Getting and Clearing the System Error Log

You can access the system error log that is maintained in the Reader/Writer.

You can read the system error log by sending a command from the host device or by using the Web browser interface.

- The system error log contains up to 15 fatal errors that were detected by the Reader/Writer during operation. They are given in chronological order.
- If more than 16 errors occur, the oldest errors are deleted in order.
- The system error log is retained in memory inside the Reader/Writer even after the power supply is turned OFF.
- You can also clear the log.
- The following record information is stored in the system error log.

Item	Description	Remarks
Time	This is the time when the system error was detected by the Reader/Writer.	
Error code	This code is used to identify the error.	Errors classified as minor faults and major faults are recorded.
Attached information 1	These codes provide additional information on the error.	For details, refer to <i>9-3 Errors and Countermeasures</i> on page 9-8.
Attached information 2		

6-6-2 Getting the Command Error Log

You can access the command error log that is maintained in the Reader/Writer.

You can read the command error log by sending a command from the host device or by using the Web browser interface.

- The command error log records up to eight records of information on host device command executions that ended in errors in chronological order.
- If more than 9 errors occur, the oldest errors are deleted in order.
- The command error log is deleted when the power supply to the Reader/Writer is turned OFF.
- The following record information is stored in the command error log.

Item	Description	Remarks
Time	This is the time when the Reader/Writer returned an error completion response to the host device.	
IP address of device that sent the command	This is the IP address of the host device that sent the Modbus/TCP command.	
Transaction ID	This is the transaction ID of the Modbus/TCP command received by the Reader/Writer.	
Command code	This code is used to identify the command.	
Error code	This code is used to identify the error.	Errors that are classified as command errors or RF Tag communications errors are recorded.
Reader/Writer Number	This shows the number identifying the Reader/Writer where an error has occurred when the Multi-Reader/Writer function is enabled.	Master Reader/Writer: 0 Slave Reader/Writers 1 to 7
Attached information 1	These codes provide additional information on the error.	For details, refer to <i>9-3 Errors and Countermeasures</i> on page 9-8.
Attached information 2		

6-6-3 Getting the Most Recent Command Error Information

You can access information on the last command for which Reader/Writer processing ended in an error.

You can read the most recent command error information by sending a command from the host device or by using the Web browser interface. The most recent command error information is deleted when the power supply to the Reader/Writer is turned OFF.

You can get the following most recent command error information.

Item	Description	Remarks
Time information	This is the time when the Reader/Writer returned an error completion response to the host device.	
IP address of device that sent the command	This is the IP address of the host device that sent the Modbus/TCP command.	
Transaction ID	This is the transaction ID of the Modbus/TCP command received by the Reader/Writer.	
Command code	This is the code that identifies the command that was executed.	
Error code	This code is used to identify the error.	
Reader/Writer Number	This shows the number identifying the Reader/Writer where an error has occurred when the Multi-Reader/Writer function is enabled.	Master Reader/Writer: 0 Slave Reader/Writers 1 to 7
Response information 1	These codes provide additional information on the error.	
Response information 2		

6-7 Maintenance: Communications Information

6-7-1 Getting the Reception Level

You can access the reception level that was measured by the Reader/Writer while processing communications with an RF Tag. You can get the reception level information by sending a command from the host device or by using an option specification for a communications command.

- The reception level information is valid only when the communications command ended normally.
- If the communications command ended in an error, a value of 0 will be returned.

Item	Description	Remarks
Reception level	-35 to -61 dBm ^{*1}	A value of 0 dBm will be returned if processing ended in an error.

*1. Values outside of the above range may be detected under some conditions.

6-7-2 Getting the Noise Level

You can measure the noise level in the environment around the Reader/Writer for each frequency channel. You can get the noise level information by sending a command from the host device.

Item	Description	Remarks
Noise level	-35 to -70 dBm ^{*1}	

*1. Values outside of the above range may be detected under some conditions.

6-7-3 Communications Diagnostics

Outline

This function diagnoses the communications leeway whenever the Reader/Writer communicates with an RF Tag, displays the results on an operation indicator, and reports the results to the host device.

With a UHF RFID system, the communications performance is affected by various environmental factors (e.g., installation distance between Reader/Writer and RF Tag, installation objects, and radio wave interference from other wireless devices). You can use the communications diagnostics to check the leeway in communications and achieve more stable RFID system operation.

The communications diagnostics information reports three main results: stable communications, unstable communications, and communications errors.

The NORM/ERR operation indicators light green for a stable communication, yellow for an unstable communication, and red for a communications error.

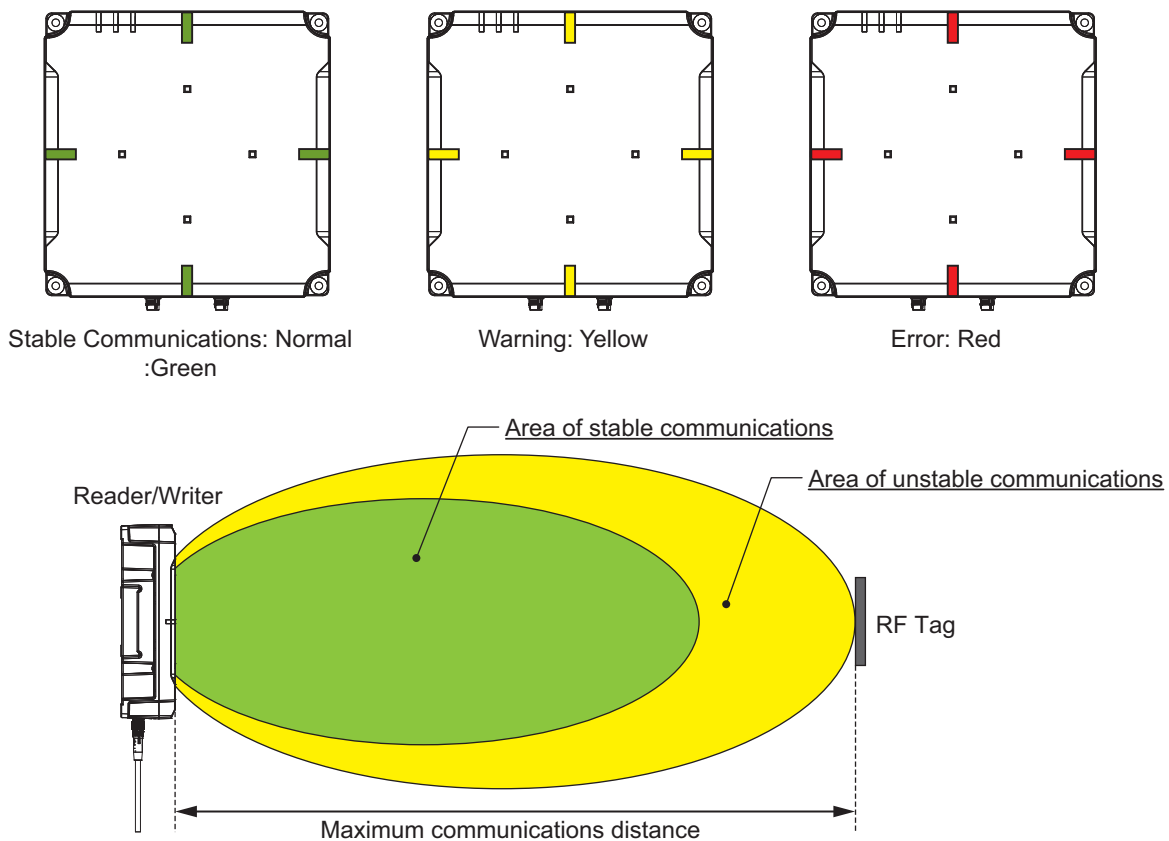



Precautions for Correct Use

- Use the results of communications diagnosis as a guideline. An indication of a stable communication (green) does not necessarily mean that communications are normal.
- An indicator of an unstable communication (yellow), does not necessarily mean that communications are not possible. It merely means that there is little leeway in communications. If you want to ensure more stable communications, we recommend that you use the Reader/Writer so that stable communications (green) are indicated.
- If you enable communications diagnostics, the communications times will be increased by up to 100 ms.
- Communications diagnostics are performed during single-access communications commands. Diagnosis is not performed for multiaccess commands.
- The communications performance in the UHF band is affected by ambient objects, such as metal objects. Therefore, perform sufficient testing in advance of actual system operation.
- RF Communications Diagnostics is disabled when Multi-Reader/Writer Function is enabled. For details, refer to “6-10-4 Communications conditions during Multi-Reader/Writer use”.

Diagnostics

Communications diagnostics give the following diagnostic results when communications are unstable.

Notification priority	Diagnostic result	Description	Remarks
High	A: Insufficient power to send	Indicates that the signal strength of the signal sent from the Reader/Writer to the RF Tag was weak.	
	B: Insufficient power to receive	Indicates that the signal strength of the signal returned from the RF Tag to the Reader/Writer was weak.	
	C: Too much noise	Indicates that the noise level around the Reader/Writer was too high.	
	D: Insufficient read data	Indicates that there was an insufficient number of successful communications with a target RF Tag that entered the communications range of the Reader/Writer, i.e., that there is no leeway in distinguishing the target RF Tag.	Diagnostic processing for these results is performed only in Focus Mode.
Low	E: Excessive read data	Indicates that the influence of a non-target RF Tag in Reader/Writer communications range prevented verifying the target RF Tag.	

You can use communications diagnosis to detect deterioration of performance for the following conditions. Use the diagnostic result to infer the cause and implement countermeasures.

Diagnostic result	Possible cause	Workaround
A/B	Communications performance was reduced by an excessive communications distance between the Reader/Writer and RF Tag.	Place the RF Tag closer to the Reader/Writer.
A/B	Communications performance was reduced because the RF Tag was inclined in relation to the Reader/Writer.	Mount the RF Tag so that it faces the Reader/Writer.

Diagnostic result	Possible cause	Workaround
A/B	Communications performance was reduced because the position of the RF Tag was offset in relation to the Reader/Writer.	Communicate with the RF Tag when it is in front of the Reader/Writer.
A/B	Communications performance was reduced because of the influence of metal around the RF Tag.	Remove all metal from around the RF Tag. * If the recommended RF Tag (V780-A-JIME-BLI-10) is mounted on a metallic material, install it on an Attachment (V780-A-TA-133-10).
A/B	Communications performance was reduced because of the influence of metal around the Reader/Writer.	Remove all metal from around the Reader/Writer. * Metal behind the Reader/Writer will not influence performance.
A/B/C/E	Communications performance was reduced due to the influence of reflected radio waves.	Change the position of physical structures or the Reader/Writer and find the best radio wave environment.
C	Communications performance was reduced by the influence of radio wave interference from a wireless device near the Reader/Writer.	Move wireless devices away from the Reader/Writer.
C	Communications performance was reduced by the influence of interference from a low-frequency device near the Reader/Writer.	Move low-frequency devices away from the Reader/Writer.
D	The RF Tag is traveling too quickly.	Reduce the speed of the RF Tag.
E	The RF Tags are too close to each other.	Separate the RF Tags farther from each other.

Getting RF Communications Diagnostic Information

You can check information on measurements and diagnostics that were performed in RF Tag communications for the last communications command that was executed by the Reader/Writer.

You can check the communications diagnostic information by sending a command from the host device. You can also use the communications option of an expanded command to get diagnostic results in one response.

The following table lists the information that you can get in the communications diagnostic information.

Item	Description	Remarks
Time	Indicates the time that the Reader/Writer communicated with the RF Tag.	
Command code	Indicates the code that identifies the communications command that was executed.	
Communications result (error code)	Indicates the code that identifies the communications command that was executed.	
Diagnostic result	Indicates the code that identifies the result of communications diagnostics. Communications normal, communications error, insufficient power to send, insufficient power to receive, too much noise, insufficient signal-to-noise ratio, insufficient read data, or excessive read data	
Diagnostic details	Indicates all diagnostic results detection status as bit information.	

Item	Description	Remarks
Channel used	Indicates the channel used when communicating with an RF Tag.	Indicates the channel selected by a Reader/Writer when the channel setting is "Automatic."
Communications speed	Indicates the communications speed when communicating with an RF Tag.	Indicates the speed selected by the Reader/Writer when the communications speed setting is "Automatic."
Reception level	Indicates the reception level measured during communications diagnostics. -35 to -61 dBm ^{*1}	
Noise level	Indicates the noise level measured during communications diagnostics. -35 to -70 dBm ^{*1}	
Target level	Indicates the target level measured during communications diagnostics. 0 to 100	This value is input only in Focus Mode.
StoredPC UII (EPC code)	Indicates the UII (EPC code) (including the StoredPC data) of the RF Tag that was communicated with during communications diagnostics.	

*1. Values outside of the above range may be detected under some conditions.

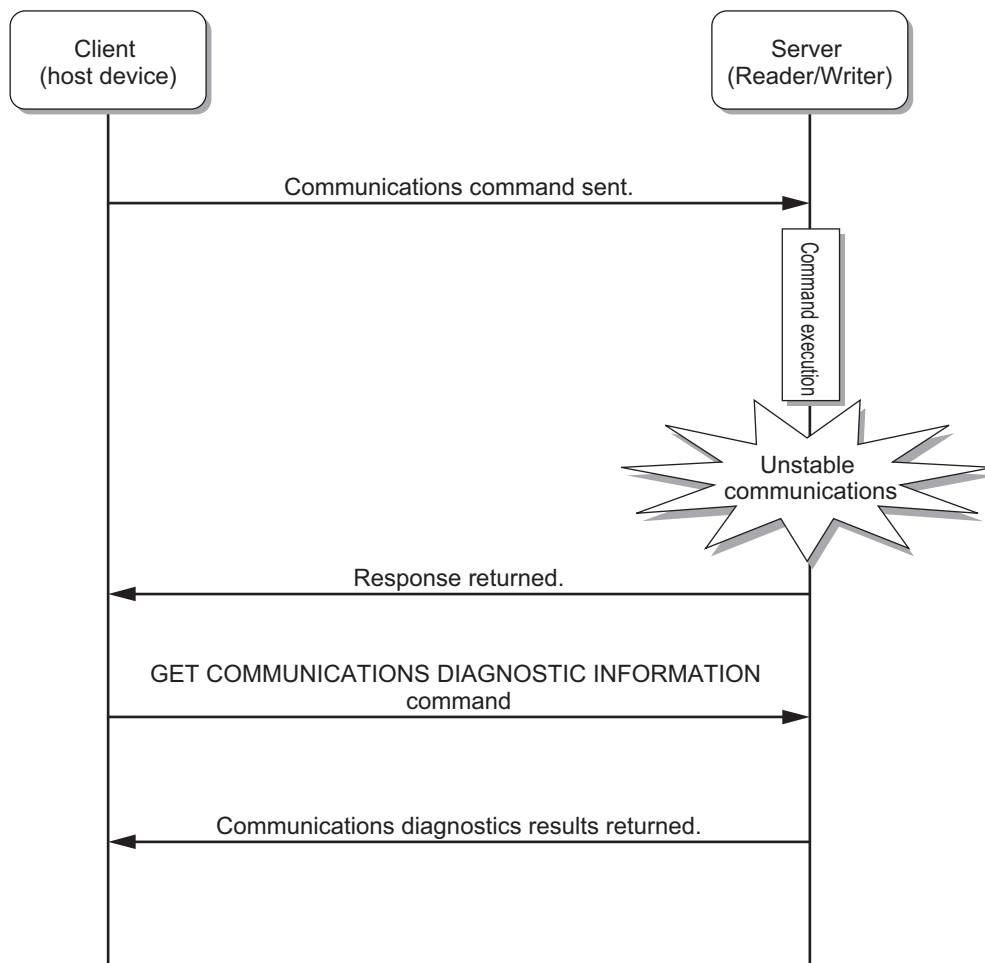

Accessing the RF Communications Diagnostics Log

You can access the information that resulted from communications diagnostics from the communications diagnostics log displayed on the Web browser interface. You can easily check to see how stable communications are and troubleshoot problems.

- The communications diagnostics log stores up to 8,192 records in time sequence of the information that resulted from diagnostics during execution of communications commands from the host device.
- If more than 8,192 records occur, the oldest records are deleted in order.
- The communications diagnostics log is deleted when the power supply to the Reader/Writer is turned OFF.

You can browse a list of diagnostic information and periodically confirm the leeway quantitatively on graphs from the Web browser interface. If you select the record in the list, details will be displayed along with the probable causes and workarounds. You can save a log file that contains the diagnostic information stored in the Reader/Writer for your usage.

Diagnostic Information Table Display

OMRON V780 RFID Reader/Writer

Log view

Command error log System error log **RF communications diagnostics log**

Total : 126 Warning : 9 Error : 51

No	Time	Command	Result	Diagnostics result	UID(EPC)
77	0:02:26	ID read	Warning	Too much noise	0038
78	0:02:26	ID read	Normal	Normal	0038
79	0:02:27	ID read	Warning	Too much noise	0038
80	0:02:27	ID read	Normal	Normal	0038
81	0:02:27	ID read	Normal	Normal	0038
82	0:02:27	ID read	Alarm	RF Tag missing error	
83	0:02:28	ID read	Alarm	RF Tag missing error	

No: 79
 Command: 0001 : ID read
 Diagnostics result: 0003 : Too much noise
 Diagnostic details: 0x0004 Reception level[dBm]: -30 Noise level[dBm]: Target level
 Used channel: 37 RF speed: Normal speed

The ambient noise level around the Reader/Writer is high.
 [Probable cause/Workaround]
 1.
 Probable cause : Communications performance was reduced due to the influence of reflected radio waves.
 Workaround : Change the position of structures.

Buttons: Update, Save, Clear

Diagnostic Information Graph

OMRON V780 RFID Reader/Writer

Log view

Command error log System error log **RF communications diagnostics log**

Total : 126 Warning : 9 Error : 51

Legend: Reception level (blue), Noise level (orange)

Y-axis: [dBm] (-10 to -70)

X-axis: Record numbers (69 to 86)

Buttons: Update, Save, Clear

6-8 Tuning

6-8-1 Transmission Power Tuning

Outline

You can measure the transmission power that is required for the Reader/Writer to communicate with an RF Tag and then adjust the transmission power.

You can set the optimum transmission power for communications with target RF Tags, i.e., the minimum required power. You can use this to prevent communicating with RF Tags you do not want to communicate with or to suppress interference with other Reader/Writers, and thereby achieve more stable RFID system operation.

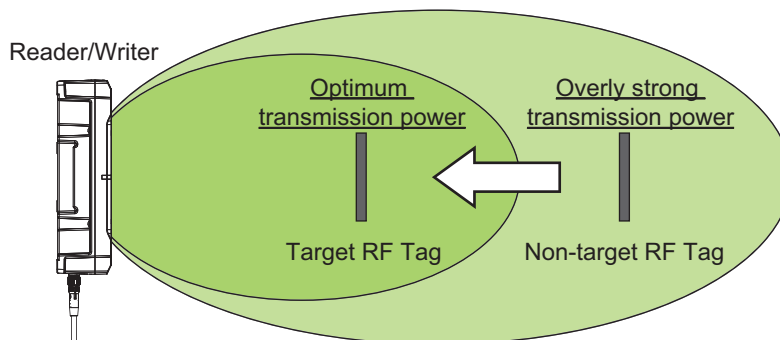

You can use the Transmission Power Tuning View on the Web browser interface to adjust the transmission power settings separately for reading and writing. When you adjust these settings from the Web browser interface, use the actual RF Tags at the same communications distance as the application. When the Reader/Writer is adjusted, it sweeps through the range of transmission powers and measures the communications status while actually reading and writing data in the RF Tag. Finally, the measurement results are used to provide information on the optimum transmission power.

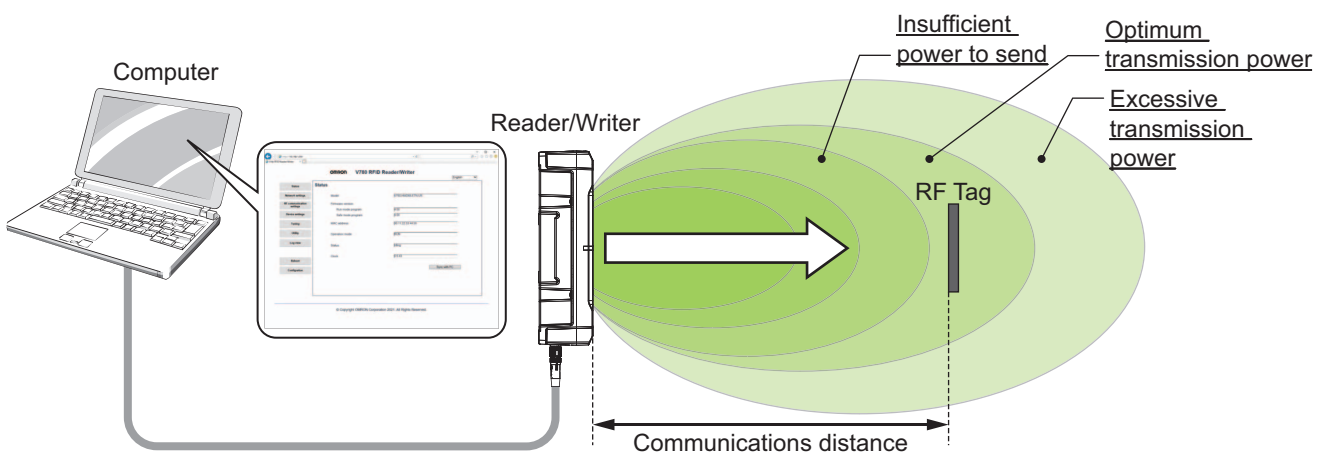



Precautions for Correct Use

- The RUN indicator will light cyan during adjustment.
- For the adjustment, place the RF Tag at the farthest distance from the Reader/Writer that would be normal in the actual application.
- Do not move the RF Tag during adjustment. Doing so will prevent determining the optimum power.
- When you use this function, use the same RF Tag that you will use in actual operation. If you change the type of RF Tag, the adjustment results will differ.
- When the write transmission power is automatically adjusted, data is actually written to the RF Tag.
- Any RF Tag communications errors that are detected as a result of communications with RF Tags during adjustments are recorded in the command error log.
- If you close the Web browser interface, transition the screen, or disconnect the communications cable during the adjustment, the test operation status (i.e., the RUN indicator lit in cyan) may continue. If that occurs, cycle the power supply to the Reader/Writer to reset it.

Transmission Power Adjustment Procedure

From the Transmission power tuning View, select either the read or write option for the transmission power adjustment.

Then, click the **Start** Button. Tuning automatically sets the optimum transmission power. You can also save the transmission power adjustment results to a file.

● Transmission Power Tuning View

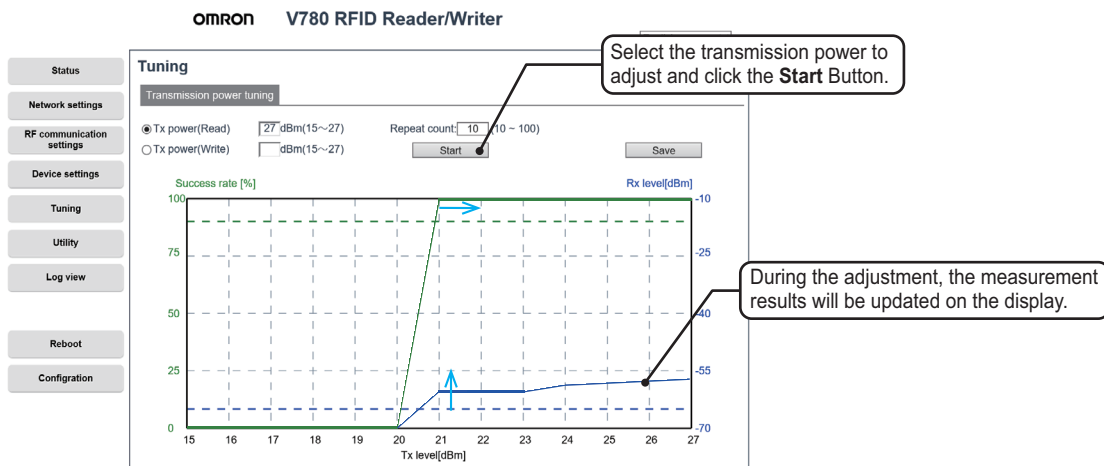

● **Transmission Power Adjustment Failure**

If the communications status changes as shown below during transmission power adjustment, adjustment has failed. Correct the installation environment and perform the adjustment again.

a) Communications Success Rate or Reception Level Is Below the Threshold

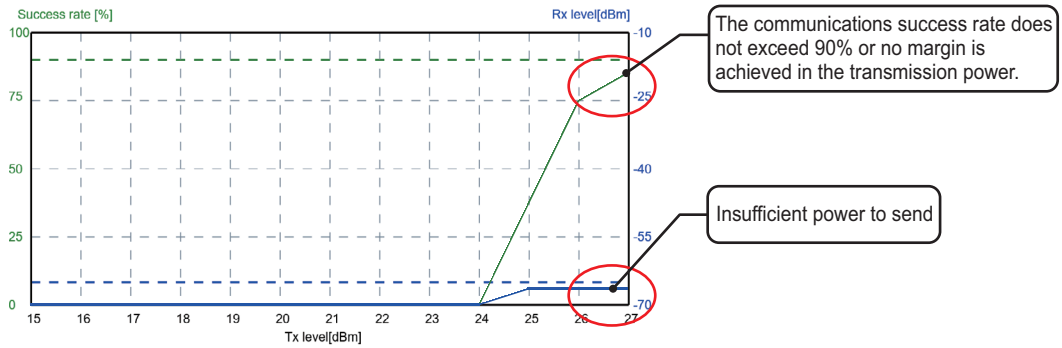

b) Communications Success Rate or Reception Level Exceeds the Threshold Then Goes Below It One or More Times

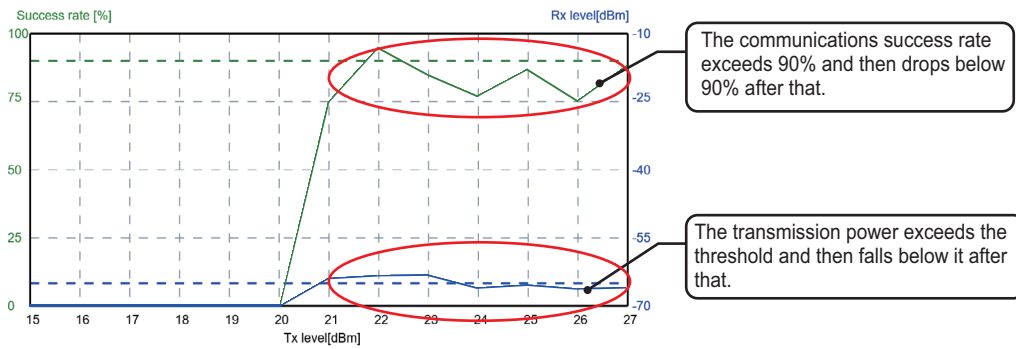

6-9 Utilities

6-9-1 RF Tag Access

Outline

You can check communications between the Reader/Writer and host device for RF Tag communications commands.

You can specify the UII (EPC code) or any address in the RF Tag to access the data.

RF Tag Access Method

The RF Tag Access View displays the communications commands sent to the Reader/Writer and the response that is received.

To start a test, select a communications command from the **RF communication command** Box and enter the parameters required for the command.

After the communications command is sent, the response from the RF Tag is displayed. If communications diagnostics are enabled, the diagnostic results are also displayed.

The time required to communicate with the RF Tag is also displayed.



Precautions for Correct Use

- RF Tag access cannot be performed with the Modbus TCP expansion for communications commands or multiaccess communications.
- You can select any of the following communications commands on the Web browser interface.

Communications command	Data address field	Data size field	Write data field
ID READ	Not used. (Grayed out.)	Not used. (Grayed out.)	Not used. (Grayed out.)
ID WRITE	Not used. (Grayed out.)	Not used. (Grayed out.)	Used. (Can be entered.)
DATA READ	Used. (Can be entered.)	Used. (Can be entered.)	Not used. (Grayed out.)
DATA WRITE	Used. (Can be entered.)	Not used. (Grayed out.)	Used. (Can be entered.)

- You can also manually enter any command and send it.

The screenshot shows the 'Utility' interface with the 'RF Tag access' tab selected. It includes fields for 'Command', 'Data address', 'Data size', and 'Write data'. A 'Send' button is present. Below these fields, the 'Response' and 'Result' are displayed. The 'Result' is shown as 'Normal' in green. A 'Time' field shows '147msec'. A 'Command/Response Log' section shows the hexadecimal data for the transmitted (Tx) and received (Rx) commands. Callouts provide additional information: one points to the 'Command' field stating that ID READ, ID WRITE, DATA READ, or DATA WRITE can be specified; another points to the 'Result' field stating that results are displayed in red, yellow, or green; and a third points to the 'Time' field stating that the communication time is displayed.

6-9-2 RF Tag Scanning

Outline

Use RF Tag access to see if there is an RF Tag in the communications range of the Reader/Writer. You can check communications with RF Tags with just one button.

Scanning Method

Click the **Start** Button on the RF Tag scan View to display information on detected RF Tags. The RF Tag scan list will display information on up to 64 RF Tags in the order that they are detected.

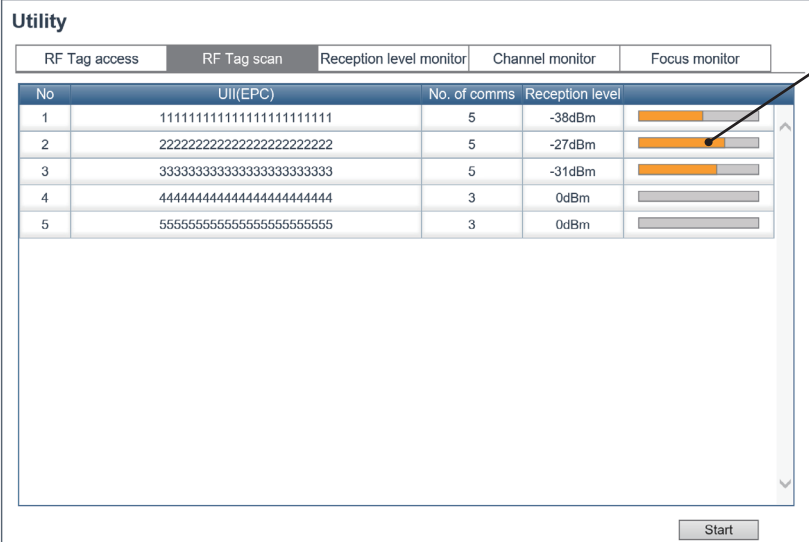

No	UII(EPC)	No. of comms	Reception level	
1	11111111111111111111111111111111	5	-38dBm	<div style="width: 100%;"></div>
2	22222222222222222222222222222222	5	-27dBm	<div style="width: 100%;"></div>
3	33333333333333333333333333333333	5	-31dBm	<div style="width: 100%;"></div>
4	44444444444444444444444444444444	3	0dBm	<div style="width: 100%;"></div>
5	55555555555555555555555555555555	3	0dBm	<div style="width: 100%;"></div>



Precautions for Correct Use

- The RUN indicator will light cyan during the scan.
- During a scan, the NORM/ERR indicators will flash once in red or green according to the results of multiaccess communications.
- During the scan, the Reader/Writer will repeatedly communicate with the RF Tags to read the IDs with multiaccess communications.
- The scan list is updated approx. every 1.5 s.
- If you close the Web browser interface, transition the screen, or disconnect the communications cable during scanning, the test operation status (i.e., the RUN indicator lit in cyan) may continue. If that occurs, cycle the power supply to the Reader/Writer to reset it.

6-9-3 Reception Level Monitor

Outline

You can check the reception level from RF Tags over time on a graph.

You can use this to adjust the installation locations of Reader/Writers and RF Tags and measure the communications ranges to achieve more stable RFID system operation.

Broadly speaking, you can use the Reception Level Monitor View to analyze two communications methods: single-access communications and multiaccess communications. You can also save the reception level information measured by the reception level monitor in a file.

Measurement Method for Single-access Communications

To analyze communications with individual RF Tags with the reception level monitor, select the Single Option and then click the **Start** Button. When analysis begins, the Reader/Writer will start taking measurements and the reception level display for the RF Tag will be updated in realtime. To stop taking measurements, click the **Stop** Button.

● Reception Level Monitor View

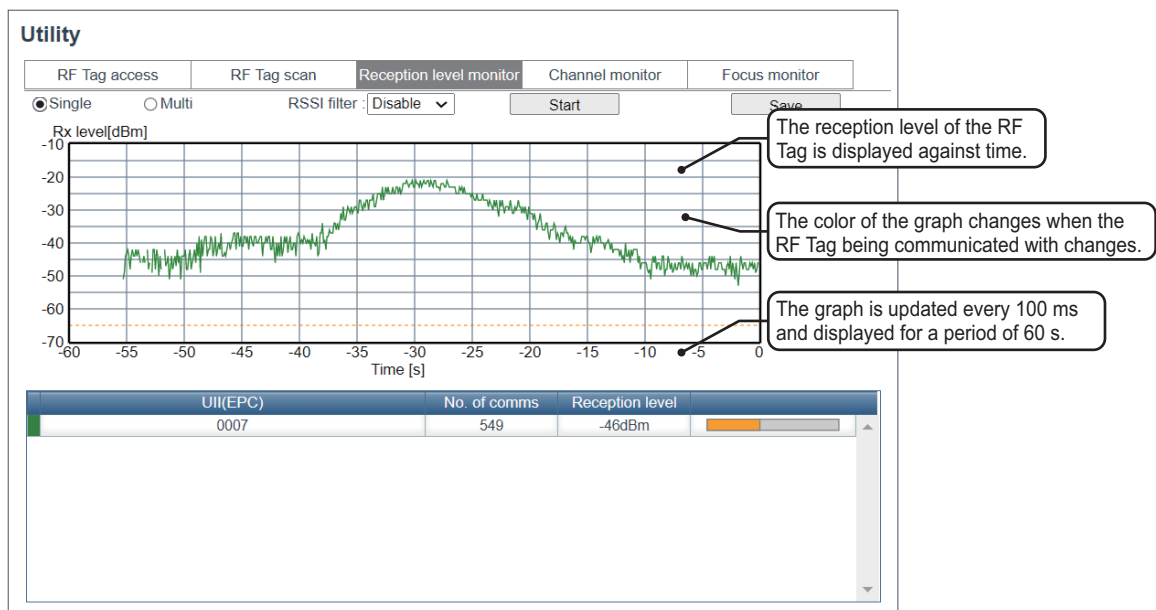













Precautions for Correct Use

- The RUN indicator will light cyan during the measurements.
- During the measurements, the Reader/Writer will repeatedly communicate with the RF Tag to read the ID.
- The reception level graph is updated every 100 ms and displayed for a period of 60 s.
- You can use the **Save** Button to download up to 1,800 measurements (100 ms x 1,800 measurements = 180 s, or 3 min).
- If you close the Web browser interface, transition the screen, or disconnect the communications cable during the measurements, the test operation status (i.e., the RUN indicator lit in cyan) may continue. If that occurs, cycle the power supply to the Reader/Writer to reset it.

● Flashing Speed of NORM/ERR Indicators

During measurements of single-access communications, operation indicators will flash and the flashing speed will indicate the reception level of the Reader/Writer. This allows you to install and adjust the Reader/Writer and RF Tags even if you cannot see the Reception Level Monitor View on the Web browser interface.

Operation indicators	Color	Status	Description
NORM/ERR	Green	 Flashing at 100-ms intervals	Communications processing ended normally with a reception level between -35 and -37 dBm.
	Green	 Flashing at 200-ms intervals	Communications processing ended normally with a reception level between -38 and -40 dBm.
	Green	 Flashing at 400-ms intervals	Communications processing ended normally with a reception level between -41 and -43 dBm.
	Green	 Flashing at 600-ms intervals	Communications processing ended normally with a reception level between -44 and -46 dBm.
	Green	 Flashing at 800-ms intervals	Communications processing ended normally with a reception level between -47 and -49 dBm.
	Green	 Flashing at 1,000-ms intervals	Communications processing ended normally with a reception level between -50 and -52 dBm.
	Green	 Flashing at 1,200-ms intervals	Communications processing ended normally with a reception level between -53 and -55 dBm.
	Green	 Flashing at 1,400-ms intervals	Communications processing ended normally with a reception level between -56 and -58 dBm.
	Green	 Flashing at 1,600-ms intervals	Communications processing ended normally with a reception level between -59 and -61 dBm.
	Green	 Flashing at 1,800-ms intervals	Communications processing ended normally with a reception level between -62 and -64 dBm.
	Yellow	 Flashing at 2,000-ms intervals	The RF Tag being communicated with has changed.
	White	 Lit	The RF Tag being communicated with has changed.
	Red	 Lit	Communications processing ended in an error.



Precautions for Correct Use

- The custom settings for the operation indicators are not used for the reception level monitor.
- The indicators will light in the above green, yellow, and red colors for the reception level monitor regardless of whether communications diagnostics are enabled or disabled.
- The custom settings for the operation indicators are not used for the reception level monitor.

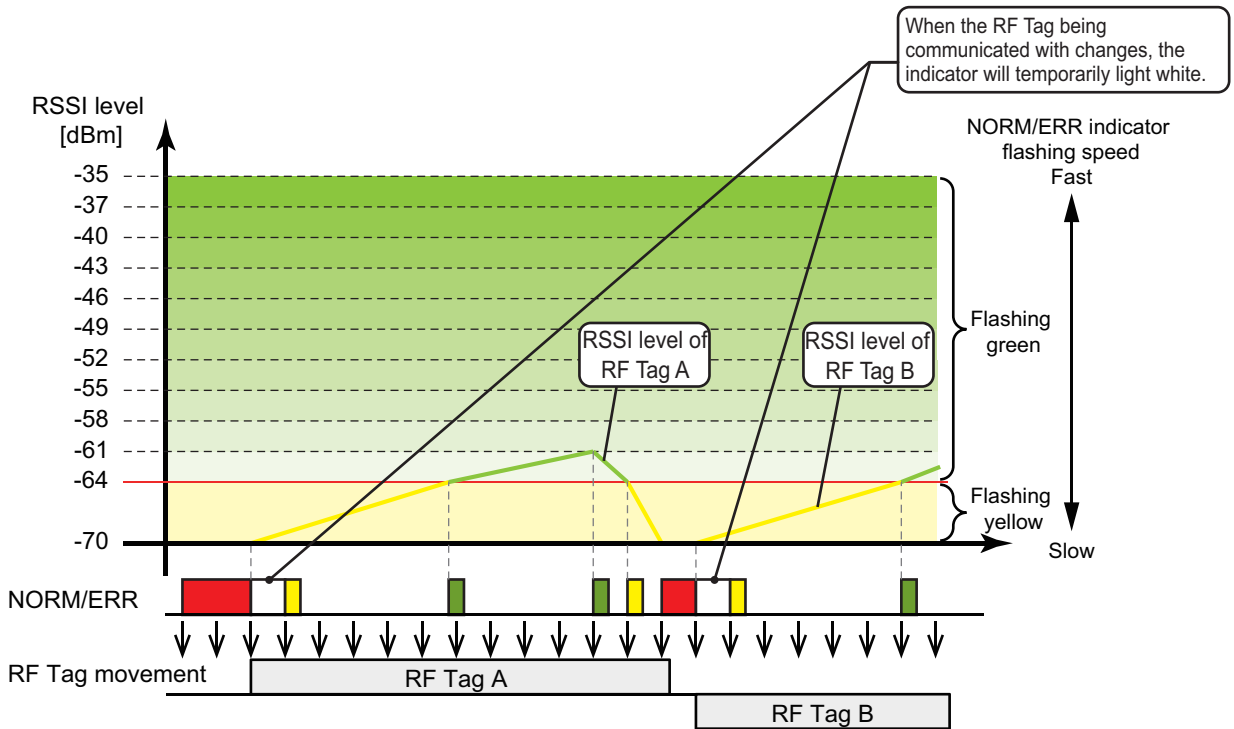
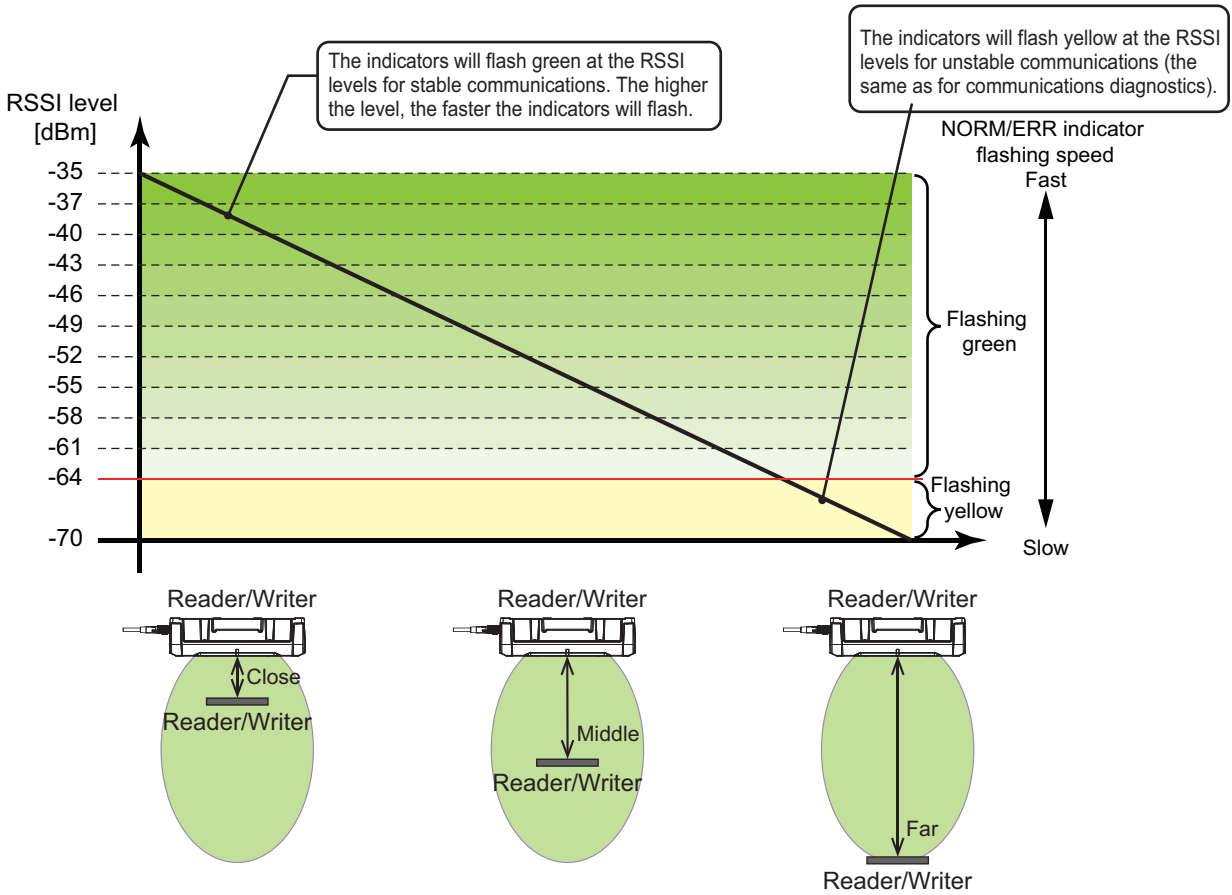

Measurement Method for Multiaccess Communications

To analyze communications with multiple RF Tags with the reception level monitor, select the *Multi* Option and then click the **Start** Button. When analysis begins, the Reader/Writer will start taking measurements for up to eight RF Tags and the reception level display for the RF Tags will be updated in realtime. To stop taking measurements, click the **Stop** Button.

● Reception Level Monitor View

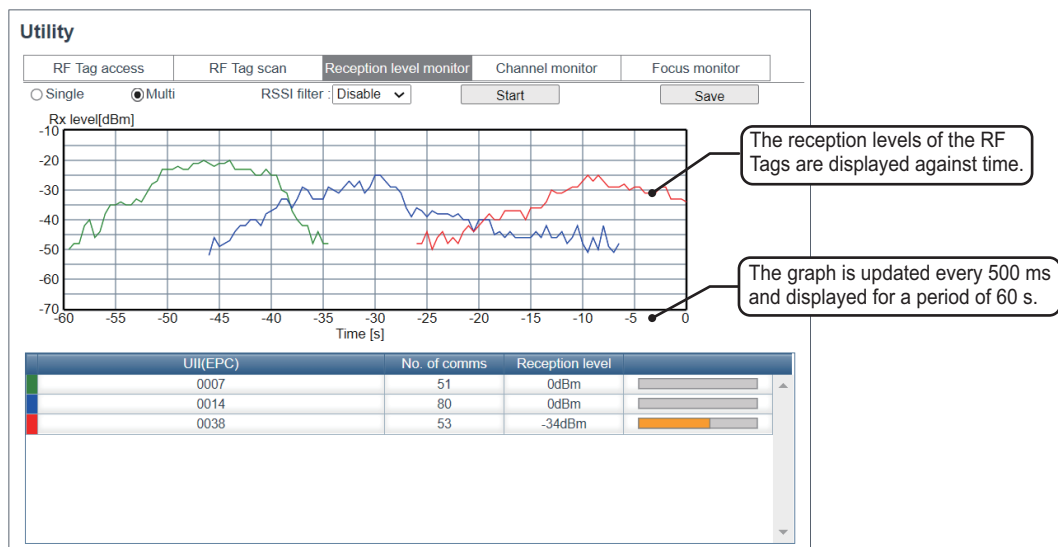

Precautions for Correct Use

- The RUN indicator will light cyan during the measurements.
- During measurements, the NORM/ERR indicators will flash once in red or green according to the results of multiaccess communications.
- During the measurements, the Reader/Writer will repeatedly communicate with the RF Tags to read the IDs with multiaccess communications.
- The reception level graph is updated every 500 ms and displayed for a period of 60 s.
- You can use the **Save** Button to download up to 360 measurements (500 ms x 360 measurements = 180 s, or 3 min).
- If you close the Web browser interface, transition the screen, or disconnect the communications cable during the measurements, the test operation status (i.e., the RUN indicator lit in cyan) may continue. If that occurs, cycle the power supply to the Reader/Writer to reset it.

6-9-4 Channel Monitor

Outline

The Reader/Writer can measure the noise level on each channel so that you can check the channels used by nearby Reader/Writers and check how much radio wave interference there is.

You can use this to identify and perform countermeasures for any equipment that are sources of noise in the application environment before you start operation or when troubles occur to achieve more stable RFID system operation.

Noise Level Measurement Method

The Channel Monitor View displays the measured noise levels of the channels on a bar graph. Click the **Start** Button to start measurements for the channel monitor. After measurements are started, the noise level will be measured for each channel and updated on the display in realtime. To stop taking measurements, click the **Stop** Button.

While monitoring the levels, the maximum noise level for each channel is displayed as the peak value.

The overall diagnostic result of channel monitoring is displayed as the status.

● Channel Monitor View

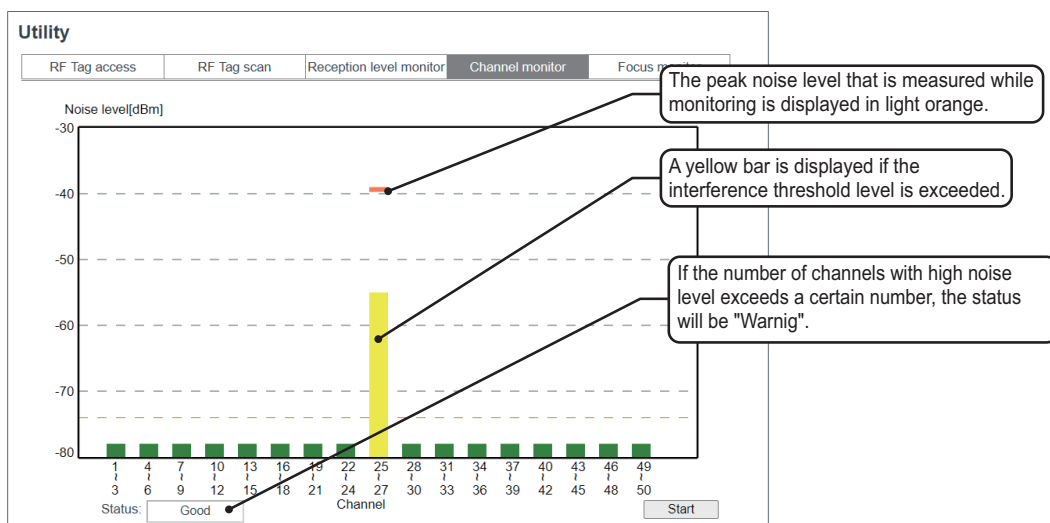

Precautions for Correct Use

- The RUN indicator will light cyan during the measurements.
- The NORM/ERR indicator will repeatedly flash green once during the measurements.
- The noise level of each channel is displayed with a bar graph. If the threshold of -74 dBm is exceeded, a yellow bar will be displayed. (The bar is green if the threshold has not been exceeded.)
- If you stop and restart monitoring, the peak noise levels will be reset.
- If the status is "Good," the ambient noise environment is good. If "Warning" is displayed, there is too much interference. The diagnostic criteria for the status depends on the model number.
- If you close the Web browser interface, transition the screen, or disconnect the communications cable during the measurements, the test operation status (i.e., the RUN indicator lit in cyan) may continue. If that occurs, cycle the power supply to the Reader/Writer to reset it.

6-9-5 Focus Monitor

Outline

The Focus Mode of the Reader/Writer uses a target level index to determine the RF Tag that is positioned in front of the Reader/Writer.

When the Reader/Writer receives a command from the host device, it communicates with the RF Tag that has the highest target level. The target levels will change according to the positions and travel speeds of the RF Tags passing through the communications range. The distance between RF Tags also has some influence on the target levels of those RF Tags.

You can use a focus monitor to check and adjust differentiation of target RF Tags and achieve more stable RFID system operation.

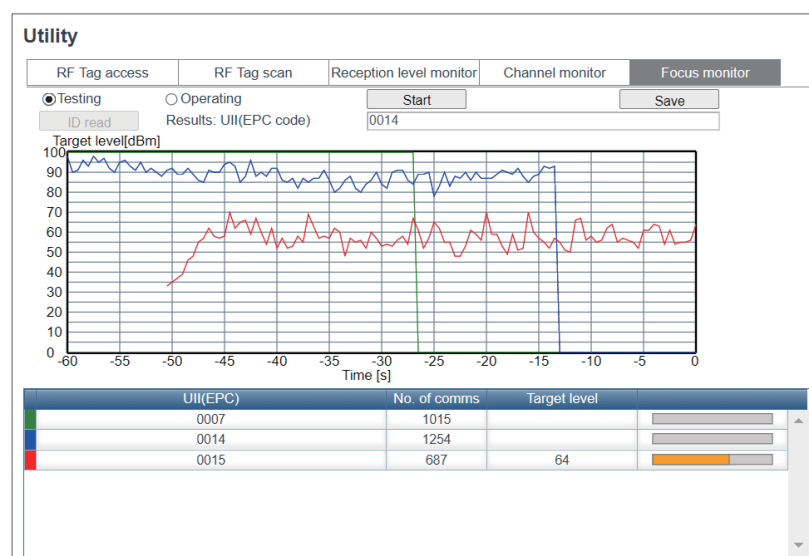

Precautions for Correct Use

- Focus Monitor is disabled when Multi-Reader/Writer Function is enabled.
For details, refer to “6-10-5 Maintenance functions during Multi-Reader/Writer use”.

Monitor Method during Tests

To perform a test, select the Testing Option on the Focus Monitor View on the Web Browser Interface and click the **Start** Button. The Reader/Writer will start measuring the target levels of the RF Tags and update the target level display for up to eight RF Tags in realtime. To stop taking measurements, click the **Stop** Button.

You can also execute a ID READ communications command at any time during the measurements. You can use this to test the operation of communications in Focus Mode.

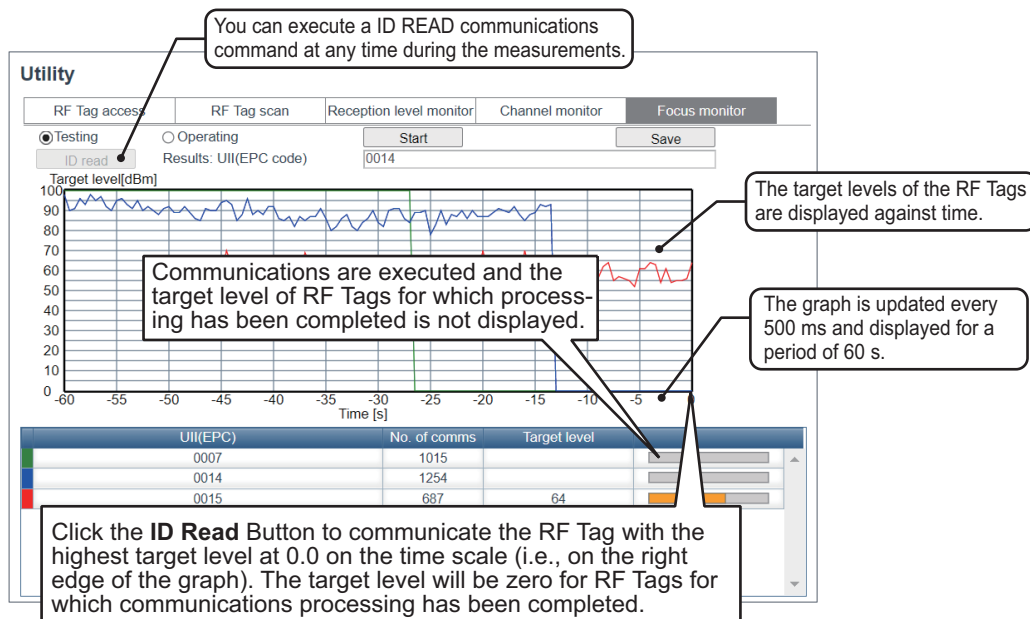

Precautions for Correct Use

- The RUN indicator will light cyan during test monitoring.
- During test monitoring, the communications mode changes to Focus Mode and the NORM/ERR indicators flashes cyan once every 3 s.
- If you execute a ID READ communications command during test monitoring, the NORM/ERR indicator will flash once in red, green, or yellow, according to the communications result.
- The target level graph is updated every 500 ms and displayed for a period of 60 s.
- You can use the **Save** Button to download up to 360 measurements (500 ms x 360 measurements = 180 s, or 3 min).
- If you close the Web browser interface, transition the screen, or disconnect the communications cable during test measurements, the test operation status (i.e., the RUN indicator lit in cyan) may continue. If that occurs, cycle the power supply to the Reader/Writer to reset it.

Monitor Method during Operation

To check the target levels during operation, select the *Operating* Option on the Focus monitor View and click the **Start** Button. The Reader/Writer will start measuring the target levels of the RF Tags and update the target level display for up to eight RF Tags in realtime. To stop taking measurements, click the **Stop** Button.

● Focus Monitor View

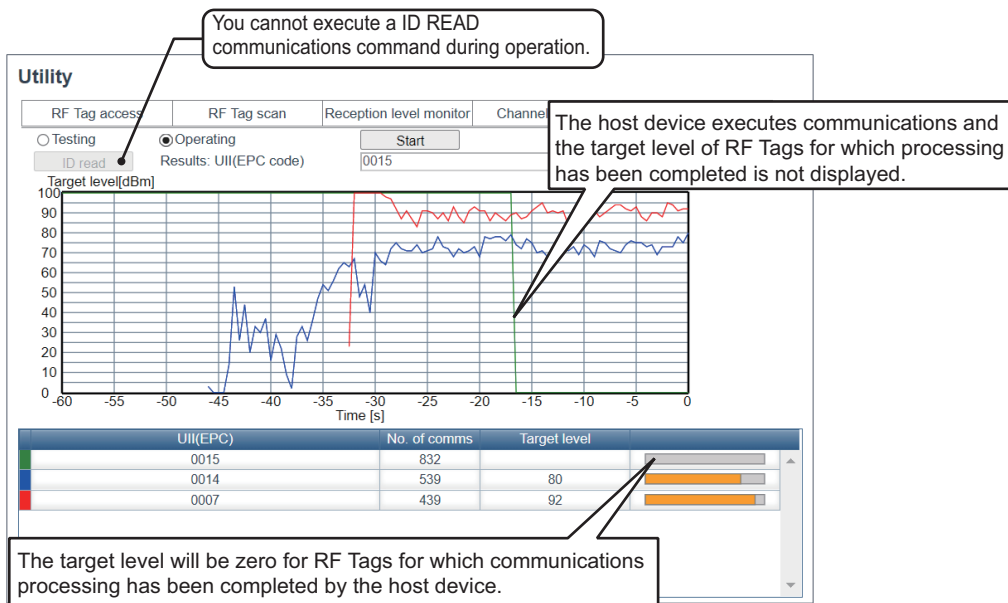

Precautions for Correct Use

- The RUN indicator will light cyan during operation.
- The target level graph is updated every 500 ms and displayed for a period of 60 s.
- You can use the **Save** Button to download up to 360 measurements (500 ms x 360 measurements = 180 s, or 3 min).

6-10 Multi-Reader/Writer Function

6-10-1 Outline

The Multi-Reader/Writer function allows connection to multiple Reader/Writers, and performs communications with RF Tags.

It can connect to a maximum of eight Reader/Writers, and performs master/slave control with one Reader/writer as the master, and the other Reader/Writers as slaves. Because multiple slave Reader/Writers can be jointly controlled simply by controlling a master Reader/Writer, it is possible to easily perform complicated controls from the host device.

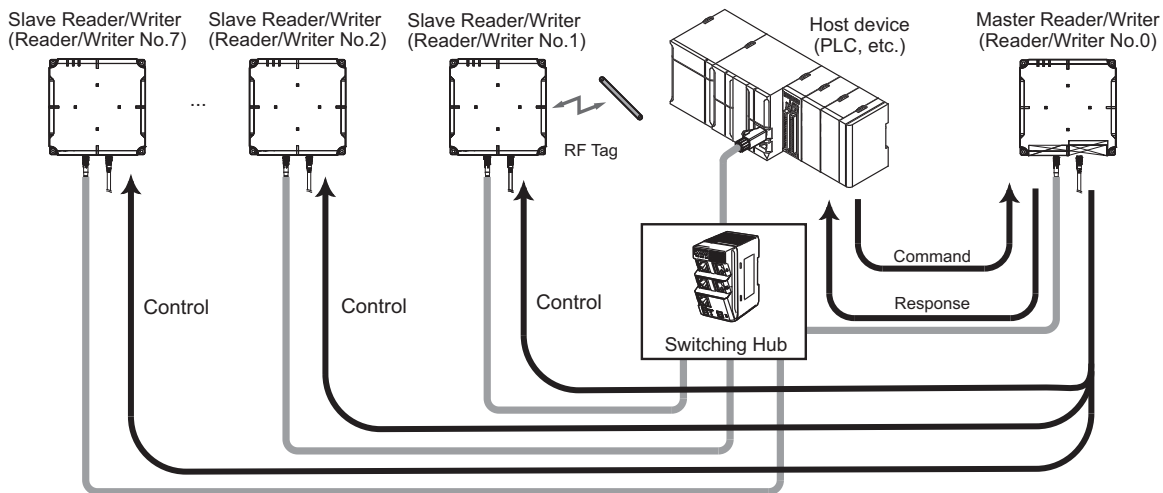

In the Multi-Reader/Writer function, the slave Reader/Writers connected to the master Reader/Writer are differentiated by the following Reader/Writer numbers.

Reader/Writer Type	Reader/Writer Number	Remarks
Master Reader/Writer	0	The Reader/Writer numbers are not used when the Multi-Reader/Writer function is disabled.
Slave Reader/Writer 1	1	
Slave Reader/Writer 2	2	The Reader/Writer numbers will be moved forward by the number of slave Reader/Writers. (Configuration with middle numbers missing is not possible)
Slave Reader/Writer 3	3	
Slave Reader/Writer 4	4	
Slave Reader/Writer 5	5	
Slave Reader/Writer 6	6	
Slave Reader/Writer 7	7	



Precautions for Correct Use

- When using this function, the Reader/Writers connected by the Multi-Reader/Writer function must all be Version 3.0 or later.
- When using this function, the Reader/Writers connected by the Multi-Reader/Writer function must all be the same model (country of specification).
- The Slave Reader/Writer (V780-HMD68-ETN-□□-S) does not accept communications commands or Reader/Writer setting commands. *1
Also, it does not accept Modbus/TCP port connection from other than the Master Reader/Writer. *2
- *1. When using a standard Reader/Writer (V780-HMD68-ETN-□□) as a slave Reader/Writer, the Getting command will be accepted.
- *2. Connection from the web port will be accepted.
- The slave reader/writer (V780-HMD68-ETN-□□-S) can not be used as a master reader/writer.
- The Modbus/TCP port number of the slave Reader/Writer must be set the default (502).
When changed, "Communications error between Reader/Writers (200B hex)" is detected.

6-10-2 Multi-Reader/Writer Modes

The processing operations for communications of multiple linked Reader/Writers differs depending on the Multi-Reader/Writer mode specified in the Reader/Writer.

The setting of the Multi-Reader/Writer mode is effective following restart. It is saved in internal memory in the Reader/Writer even after the power supply is turned OFF.

Name	Description	Remarks
Communications Range Extension Mode	This virtually extends the communications range with multiple Reader/Writers, and communicated with RF Tags detected by any of the Reader/Writers.	

Combination of Communications Modes

Name	Once	Auto	Focus
Communications Range Extension Mode	Supported	Supported	Not supported

Combination of Communications Commands

Command name	Communications Range Extension Mode
ID READ	Supported
ID WRITE	Supported
DATA READ	Supported
DATA WRITE	Supported
LOCK	Supported
DATA FILL	Supported
MULTIACCESS ID READ	Supported
MULTIACCESS DATA READ	Supported
EXTENDED DATA READ	Supported
EXTENDED DATA WRITE	Supported
EXTENDED MULTIACCESS ID READ	Supported
EXTENDED MULTIACCESS DATA READ	Supported

Supported: Available, Not supported: Unavailable



Precautions for Correct Use

- When starting up with an unavailable Multi-Reader/Writer mode and communications mode combination, the master Reader/Writer will detect the minor fault "Multi-Reader/Writer Cannot Start."

Communications Range Extension Mode

This virtually extends the communications range with multiple Reader/Writers, and communicated with RF Tags detected by any of the Reader/Writers.

Use RF Tag communications in the following applications.

- Once multiple RF Tags passing through in logistics/transport, etc., have been read, RF Tag communications are possible at high reading accuracy by arranging multiple Reader/Writers and creating a wide communications range.

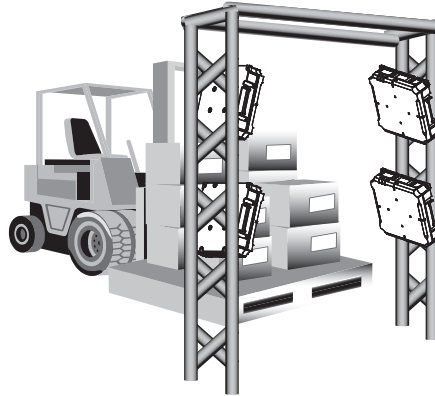

- If a point where the RF Tags are unreadable (null point) is generated due to the cancellation (multi-path) of the radio waves due to reflected wave in the ambient environment, RF Tag communications will be possible at high reading accuracy if multiple Reader/Writers are arranged, supplementing the null point.

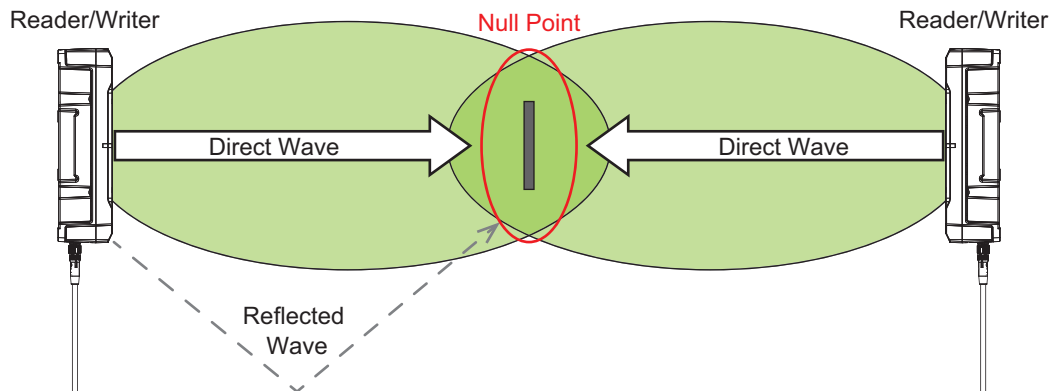

● **Operation of "Once" Communications Mode**

- If the RF Tag completes normally in any of the Reader/Writers in single-access

The master Reader/Writer communicates with the RF Tags by switching control of itself and the Slave Reader/Writers in time division. When "RF Tag Missing Error" or "RF Tag Communications Error" are detected in the communications processing of the Reader/Writers, the communications processing continues through switching the control in the order of Master → Slave 1 → Slave 2 → Slave 3, and repeats this until timeout. When an RF Tag is detected and completes normally, it returns the communications results without waiting for a timeout.

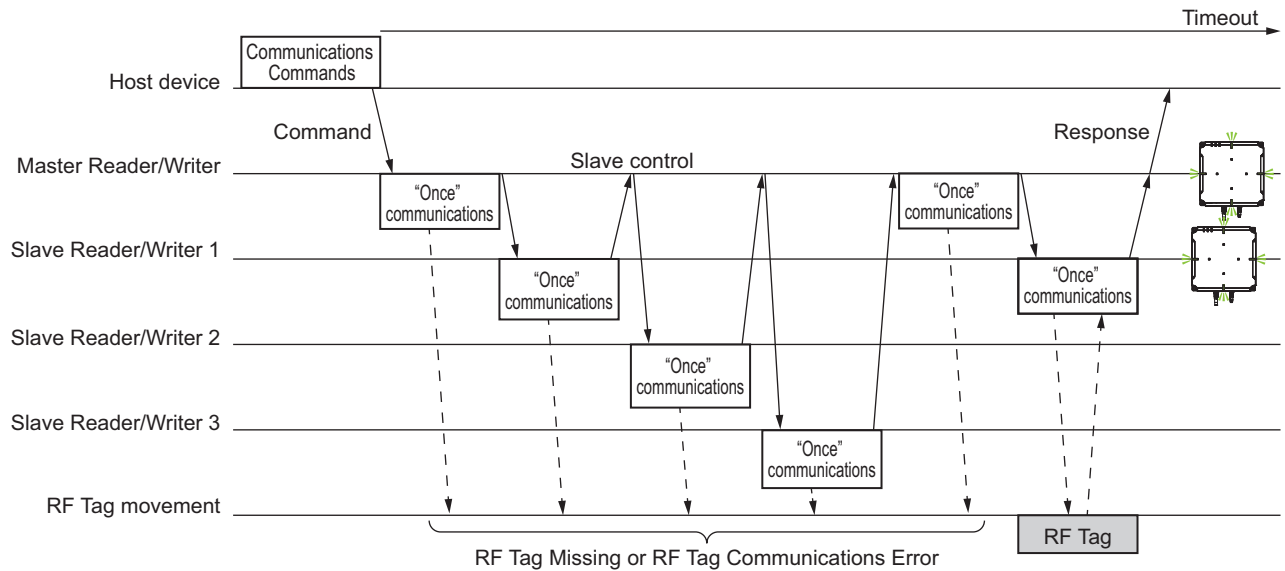

6-10 Multi-Reader/Writer Function

- If communications with an RF Tag completes abnormally in any of the Reader/Writers in single-access

The master Reader/Writer communicates with the RF Tags by switching control of itself and the Slave Reader/Writers in time division. When an RF Tag is detected and completes abnormally (other than the "RF Tag Missing Error" and "RF Tag Communications Error"), it returns the communications results without waiting for a timeout.

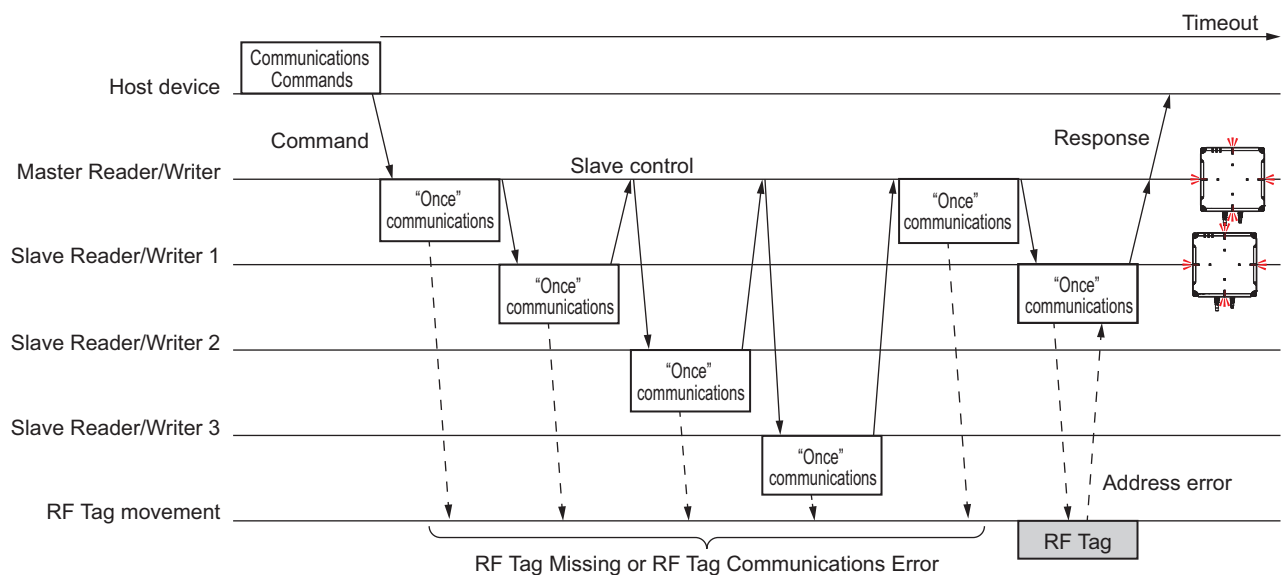

6

6-10-2 Multi-Reader/Writer Modes



Precautions for Correct Use

- While Multi-Reader/Writer communications processing is continuing, the NORM/ERR indicators will not light red even if "RF Tag Missing Error" or "RF Tag Communications Error" is detected in a Reader/Writer.
- The NORM/ERR indicator lamp of the Reader/Writer will light green/red after normal completion/error completion in Multi-Reader/Writer communications processing. Finally, the NORM/ERR indicators of the master Reader/Writer will light green/red when replying to the host device.

- If multiple RF Tags are detected by any of the Reader/Writers in multiaccess

The master Reader/Writer communicates with the RF Tags by switching control of itself and the Slave Reader/Writers in time division. While detecting multiple RF Tags within the timeout time, communications processing will repeat by switching in the sequence of Master → Slave 1 → Slave 2 → Slave 3, and the communications result will be returned after timeout.

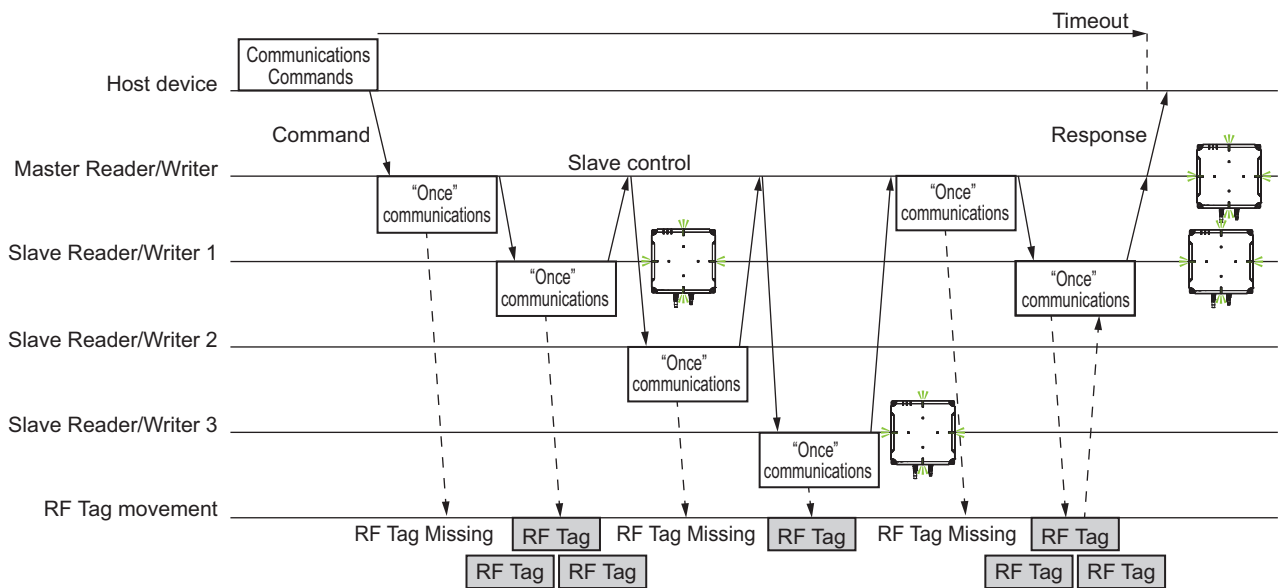

- If no RF Tags exist in any of the Reader/Writers in single-access/multiaccess

When the master Reader/Writer cannot complete communications within the timeout time, the communications results ("RF Tag Missing Error" or "RF Tag Communications Error") will be returned after timeout. If a duplicate "RF Tag Communications Error" is detected in the same RF Tag, the first Reader/Writer detected will be returned.

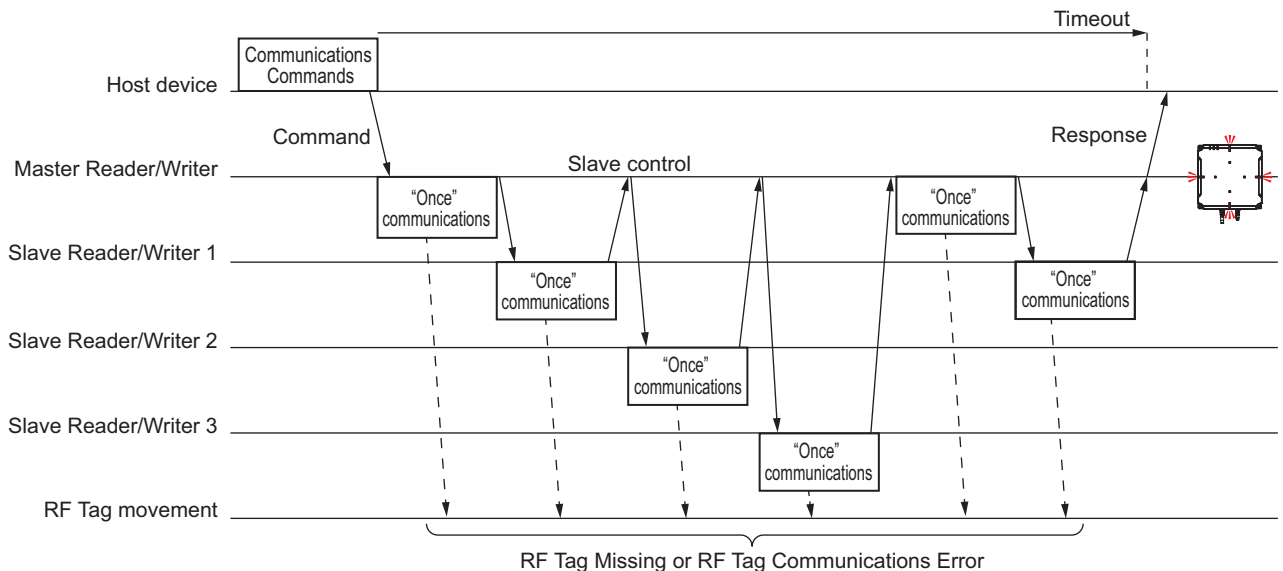

● **Operation of the "Auto" Communications Mode**

- If the RF Tag completes normally in any of the Reader/Writers in single-access

The master Reader/Writer switches the control of itself and the Slave Reader/Writers in time division, waits for the entrance of the RF Tags into any of the communications range, and will return the communications result after detection.

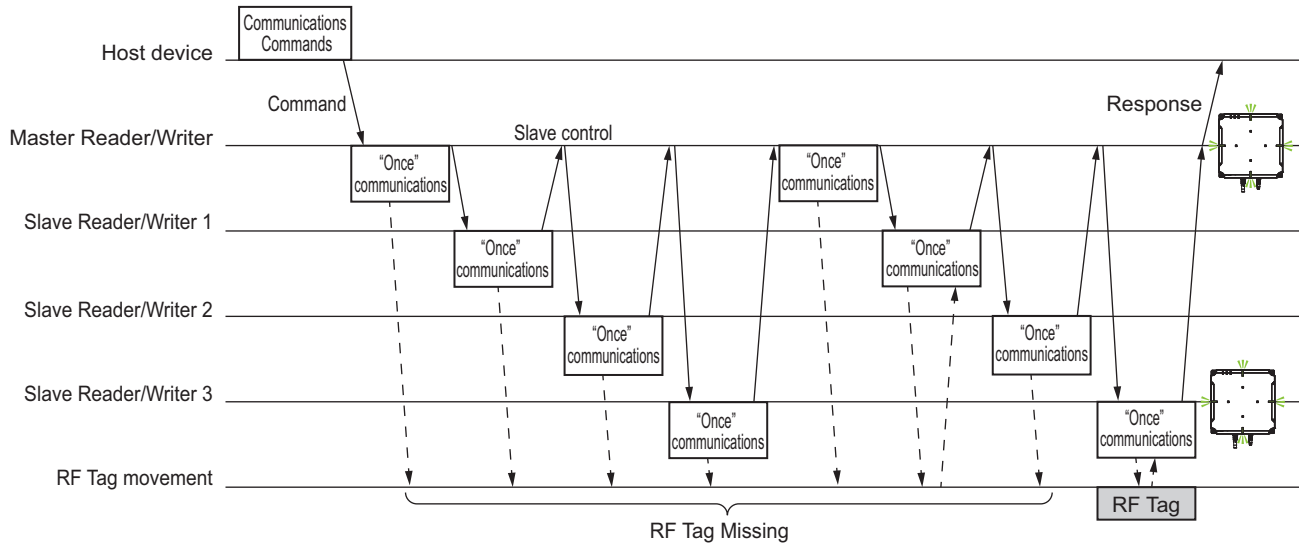

- If the RF Tag completes normally in any of the Reader/Writers in multiaccess

The master Reader/Writer switches the control of itself and the Reader/Writers in time division, waits for the entrance of the RF Tags into any of the communications range, and communications will start if even one RF Tag is detected. Then, if the Reader/Writer detects more RF Tags within the timeout time from the start of communications, it waits for the timeout and then returns the communications results.

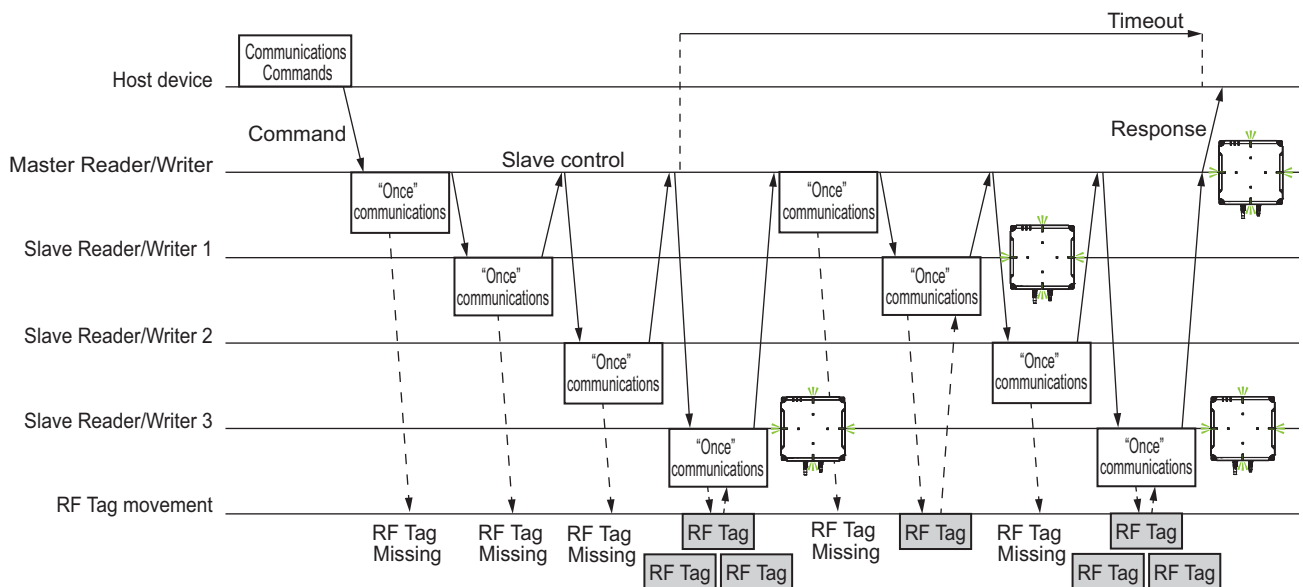

6-10-3 Application

Use this function according to the usage procedure example of the Multi-Reader/Writer mode.

Here, we give an example of the installation of four Reader/Writers as shown in the figure below.

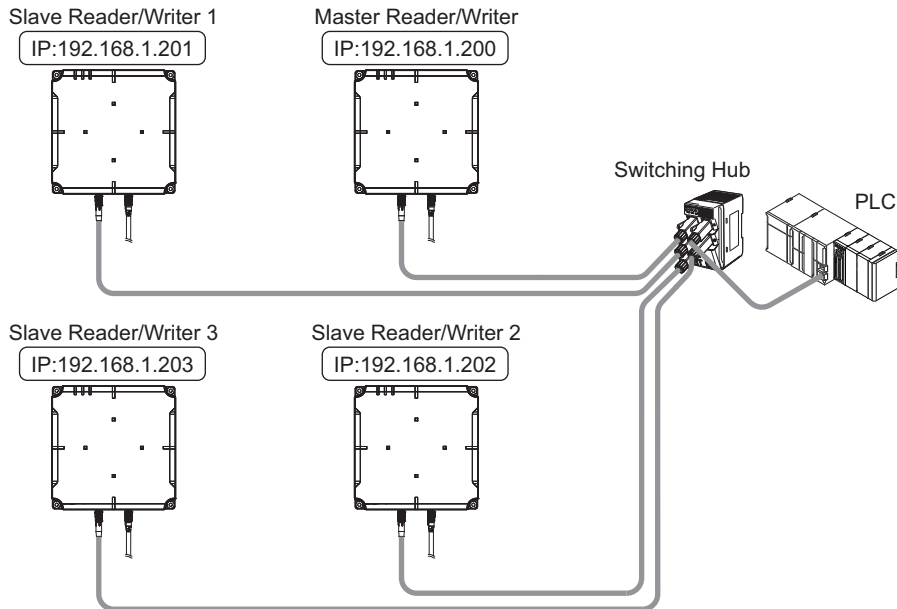

Precautions for Correct Use

Communication range extension mode can not be used only with the slave reader / writer (V780-HMD68-ETN-□□-S).

Be sure to use at least one master reader / writer (V780-HMD68-ETN-□□).

Enable the Communications Range Extension Mode

- 1 Set the same network IP address in all of the Reader/Writers. Connect the Ethernet cable, and start up.
- 2 Start up the web browser on the PC, and specify the IP address of the master Reader/Writer.
- 3 Click the **Device Settings** Button and then click the **Multi-Reader/Writer setting** Tab, Multi-Reader/Writer setting tab page will be displayed.

Device settings

LED custom settings Multi Reader/Writer setting

Multi Reader/Writer mode Disable Enable Field extension mode ▼

	IP address	Status	Tx power(Read)	Tx power(Write)
Slave Reader/Writer1	192.168.1.201	Not registered	27 dBm(15~27)	27 dBm(15~27)
Slave Reader/Writer2	192.168.1.202	Not registered	27 dBm(15~27)	27 dBm(15~27)
Slave Reader/Writer3	192.168.1.203	Not registered	27 dBm(15~27)	27 dBm(15~27)
Slave Reader/Writer4		Not registered	27 dBm(15~27)	27 dBm(15~27)
Slave Reader/Writer5		Not registered	27 dBm(15~27)	27 dBm(15~27)
Slave Reader/Writer6		Not registered	27 dBm(15~27)	27 dBm(15~27)
Slave Reader/Writer7		Not registered	27 dBm(15~27)	27 dBm(15~27)

Update Set

- 4 Place a check mark to enable the Multi-Reader/Writer mode. Then, specify the IP addresses for the slave Reader/Writers (3 units), and press the **Set** Button. This will restart the master Reader/Writer.
- 5 When the master Reader/Writer has restarted, it will perform connection processing with each of the registered slave Reader/Writers. The RUN indicator will change to yellow, which connected as slave Reader/Writers.

- 6** The master Reader/Writer will establish communications with all of the slave Reader/Writers, completing connection processing. You can check the Status of Multi-Reader/Writer setting view that completed connection.

Device settings

LED custom settings Multi Reader/Writer setting

Multi Reader/Writer mode Disable Enable Field extension mode v

	IP address	Status	Tx power(Read)	Tx power(Write)
Slave Reader/Writer1	<input type="text" value="192.168.1.201"/>	Connected	<input type="text" value="27"/> dBm(15~27)	<input type="text" value="27"/> dBm(15~27)
Slave Reader/Writer2	<input type="text" value="192.168.1.202"/>	Communication failure	<input type="text" value="27"/> dBm(15~27)	<input type="text" value="27"/> dBm(15~27)
Slave Reader/Writer3	<input type="text" value="192.168.1.203"/>	Not connected	<input type="text" value="27"/> dBm(15~27)	<input type="text" value="27"/> dBm(15~27)
Slave Reader/Writer4	<input type="text"/>	Not registered	<input type="text" value="27"/> dBm(15~27)	<input type="text" value="27"/> dBm(15~27)
Slave Reader/Writer5	<input type="text"/>	Not registered	<input type="text" value="27"/> dBm(15~27)	<input type="text" value="27"/> dBm(15~27)
Slave Reader/Writer6	<input type="text"/>	Not registered	<input type="text" value="27"/> dBm(15~27)	<input type="text" value="27"/> dBm(15~27)
Slave Reader/Writer7	<input type="text"/>	Not registered	<input type="text" value="27"/> dBm(15~27)	<input type="text" value="27"/> dBm(15~27)

- 7** After this, the multiple Reader/Writers shall jointly operate by the issuing of communications commands from the host device to the master Reader/Writer.



Precautions for Correct Use

- The Multi-Reader/Writers shall repeat connection processing if communications are not established with the registered slave Reader/Writers, and connection processing is not completed (IP address specification error, Reader/Writer non-startup, etc.). The NORM/ERR indicator will light red at a specific interval until connection processing is completed.

Executing DATA READ Using the Communications Range Extension Mode

- If the "RF Tag Communications Option" of the master Reader/Writer is "Once"

1 This will issue a DATA READ command from the host device to the master Reader/Writer.

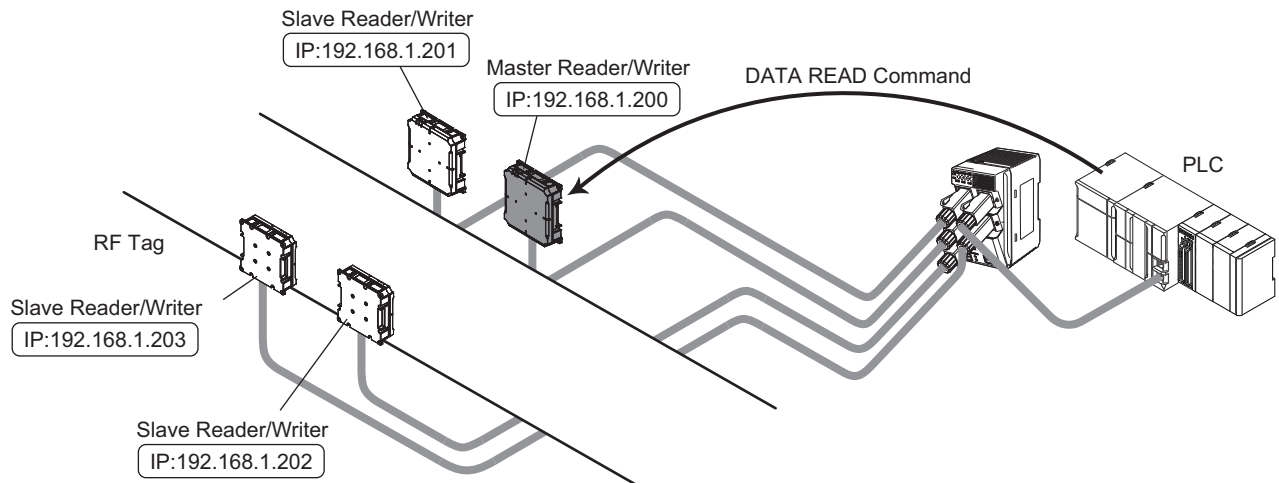

2 The master Reader/Writer will communicate with the RF Tags with the "Once" communications option. Here, if the communications have ended normally, or if the communications have ended with an error, a response is returned to the host device, and the processing ends. If an RF Tag Missing error or a communications error is detected, it will progress to step 3.

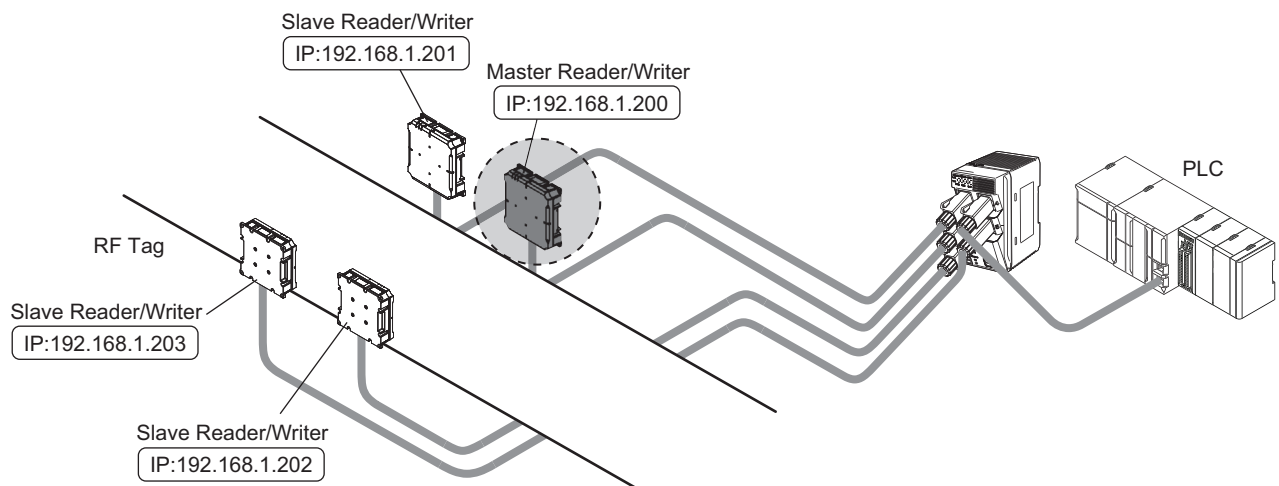

- 3** Slave No. 1 will communicate with the RF Tags with the "Once" communications option. Here, if the communications have ended normally, or if the communications have ended with an error, a response is returned to the host device, and the processing ends. If an RF Tag Missing error or an RF Tag communications error is detected, the processing will continue in the order of Slave No. 2, Slave No. 3.

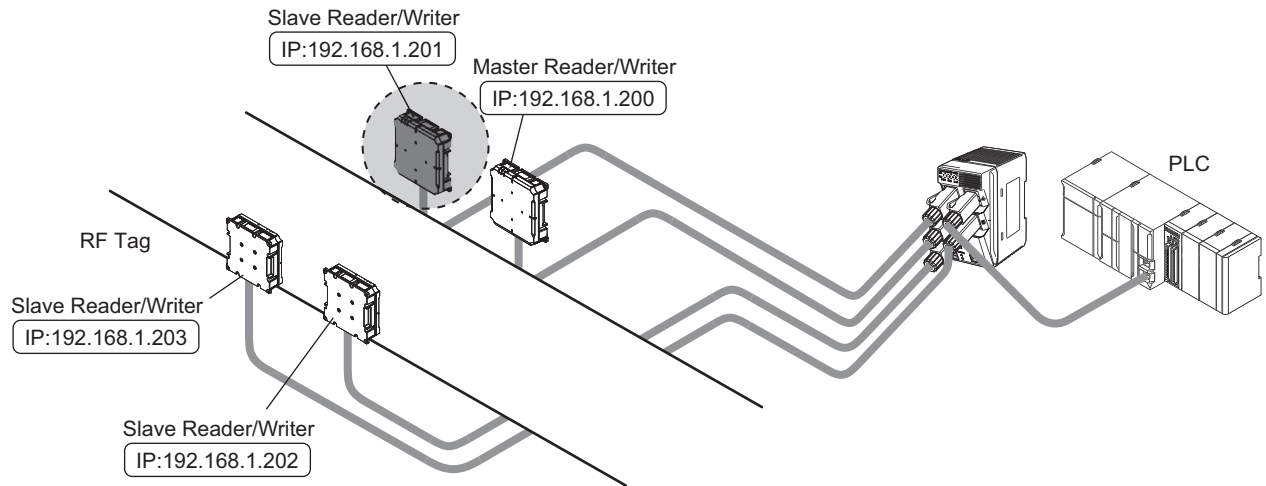

- 4** After the communications process of the Slave Reader/Writer comes a full circle, the operation is repeated from step 2. If the timeout time elapses during the communications process, a response (RF Tag Missing error or RF Tag communications error) is returned to the host device, and the processing ends.

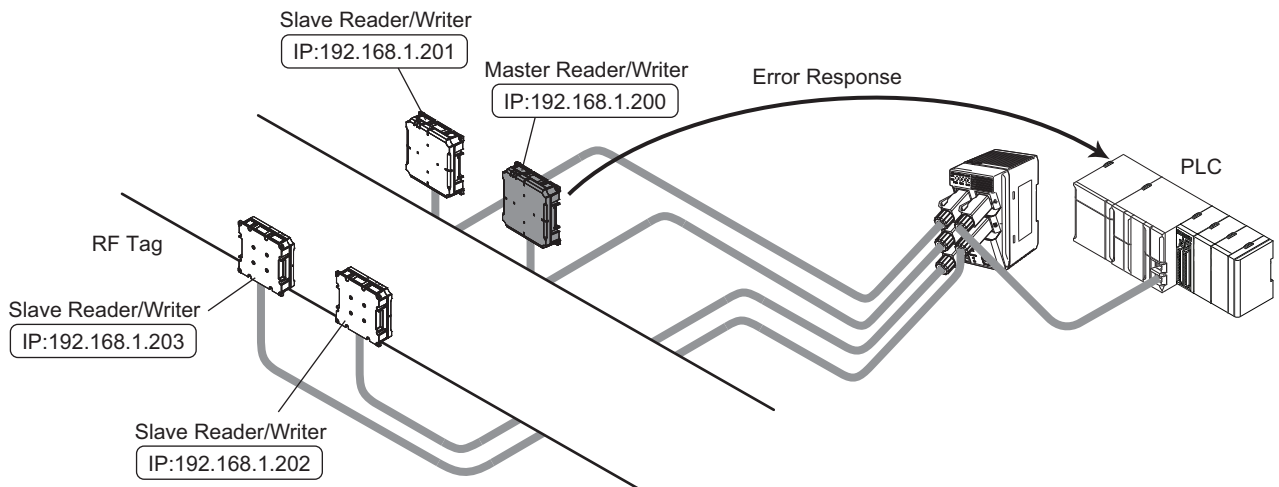

● If the "RF Tag Communications Option" of the master Reader/Writer is "Auto"

1 This will issue a DATA READ Command from the host device to the master Reader/Writer.

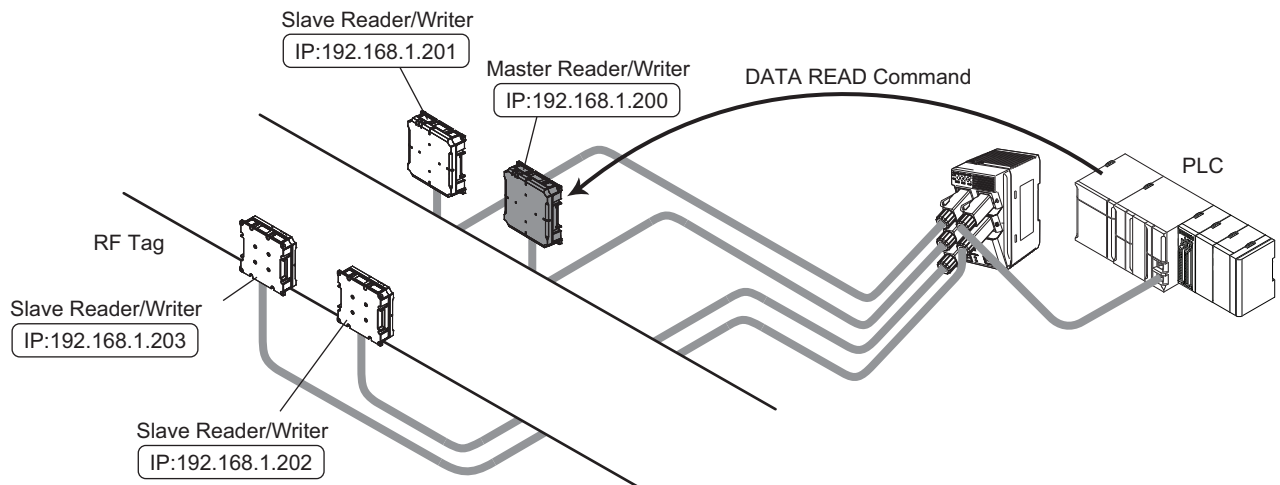

2 The master Reader/Writer will communicate with the RF Tags with the "Once" communications option. Here, if the communications have ended normally, or if the communications have ended with an error, a response is returned to the host device, and the processing ends. If an RF Tag Missing error or a communications error is detected, it will progress to step 3.

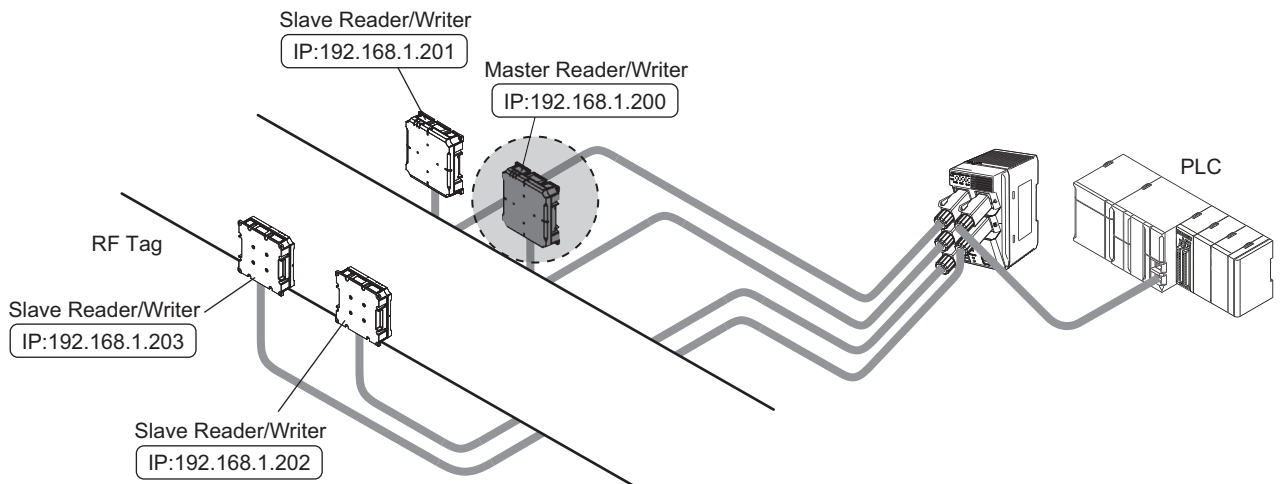

- 3** Slave No. 1 will communicate with the RF Tags with the "Once" communications option. Here, if the communications have ended normally, or if the communications have ended with an error, a response is returned to the host device, and the processing ends. If an RF Tag Missing error or a communications error is detected, the processing will continue in the order of Slave No. 2, Slave No. 3.

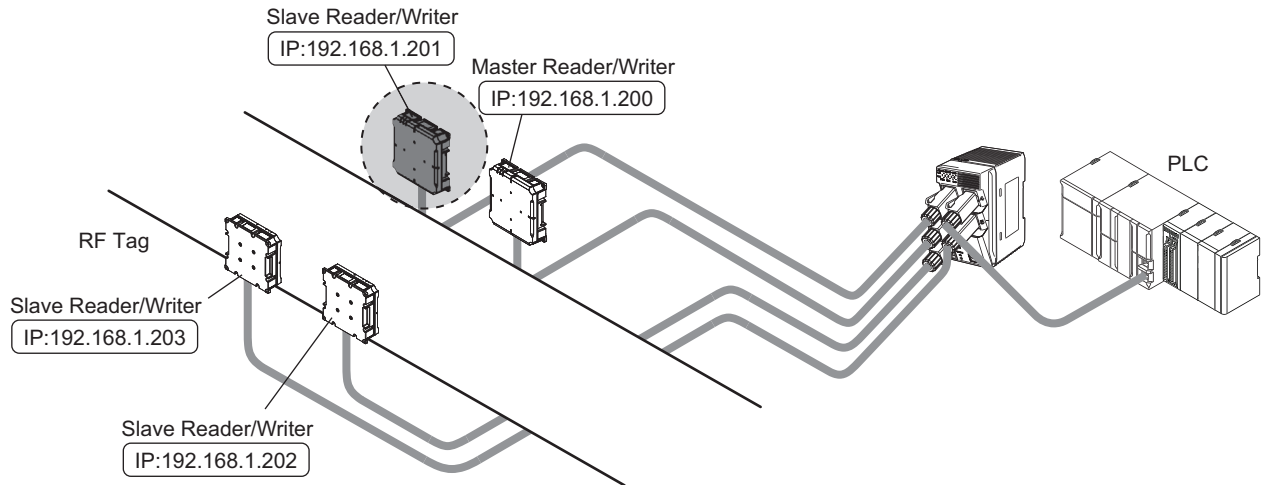

- 4** After the slave Reader/Writer communications processing has completed one cycle, operation will repeat from Procedure 2.

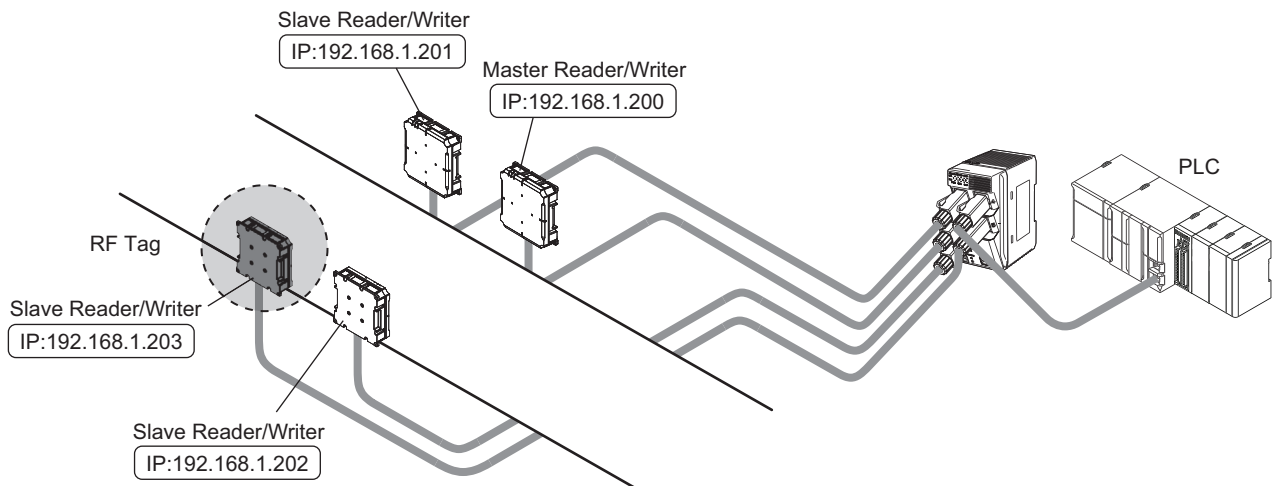

Precautions for Correct Use

- The respective Reader/Writers will not perform simultaneous communications operations in the Communications Range Extension Mode. The respective Reader/Writers will perform communications operations with time division.

6-10-4 Communications conditions during Multi-Reader/Writer use

While the Multi-Reader/Writer is enabled, the master Reader/Writer communications conditions can be set for each individual slave Reader/Writer or globally set for all Reader/Writers. The various setting items are as follows:

Setting classification	Setting item	Description	Remarks
SET TAG COMMUNICATIONS CONDITIONS (Basic)	Communications mode	Global	
	Communications speed	Global	
	Communications timeout time	Global	The "RF Communications Timeout Time" setting of the master Reader/Writer is the timeout time relative to the total communications processing in conjunction with multiple Reader/Writers.
	Write verify	Global	
	RF communication diagnostics	Global	The diagnostics function is disabled.
SET TAG COMMUNICATIONS CONDITIONS (Advanced)	Transmission power	Individual	The transmission power of the slaves is maintained by the master Reader/Writer.
	Channel	Global	
	Gen2 Session	Global	
	Access password	Global	
	Transmission time	Global	
	RSSI filter	Individual	Set individually in each Reader/Writer before enabling Multi-Reader/Writer.
	RF Tag select filter	Global	

6-10-5 Maintenance functions during Multi-Reader/Writer use

With the Multi-Reader/Writer function enabled, the various maintenance functions available in the Web browser interface will operate as follows:

View classification	Tab page classification	Description	Remarks
Tuning	Transmission Power Tuning	It is possible to tune the transmission power for each Reader/Writer on the Multi-Reader/Writer configuration.	
Utilities	RF Tag Access	It is possible to confirm communications command/response communications when multiple Reader/Writers have performed joint operation.	Implementation in Single-access Communications
	RF Tag Scanning	It is possible to confirm the presence of peripheral RF Tags when multiple Reader/Writers perform joint operation.	Implementation in Multiaccess Communications
	Reception level monitor	It is possible to confirm the reception level for each Reader/Writer on the Multi-Reader/Writer configuration.	
	Channel Monitor	It is possible to confirm the channel usage state of peripheral devices for each Reader/Writer on the Multi-Reader/Writer configuration.	
	Focus Monitor	Button operation is disabled.	The Multi-Reader/Writer functions and Focus functions cannot be used together.
Logs	Command error log	This displays the command errors during joint operation of multiple Reader/Writers.	
	System error log	This displays just the system errors of the master Reader/Writer.	Reference the system errors of the slave Reader/Writers via the direct Web browser interface and commands.
	RF Communications Diagnostics Log	Communications diagnostic information is not displayed during joint operation of multiple Reader/Writers.	The Multi-Reader/Writer functions and Communications Diagnostics functions cannot be used together.

Transmission Power Tuning for Multiple Reader/Writers

You can use the Transmission Power Tuning View (click the **Device Settings** Button and then click the **Multi-Reader/Writer setting** Tab) on the Web browser interface, to adjust the transmission power settings separately for the master or slave Reader/Writer.

You can specify the target Reader/Writer number to adjust on the Transmission Power Tuning Tab Page.

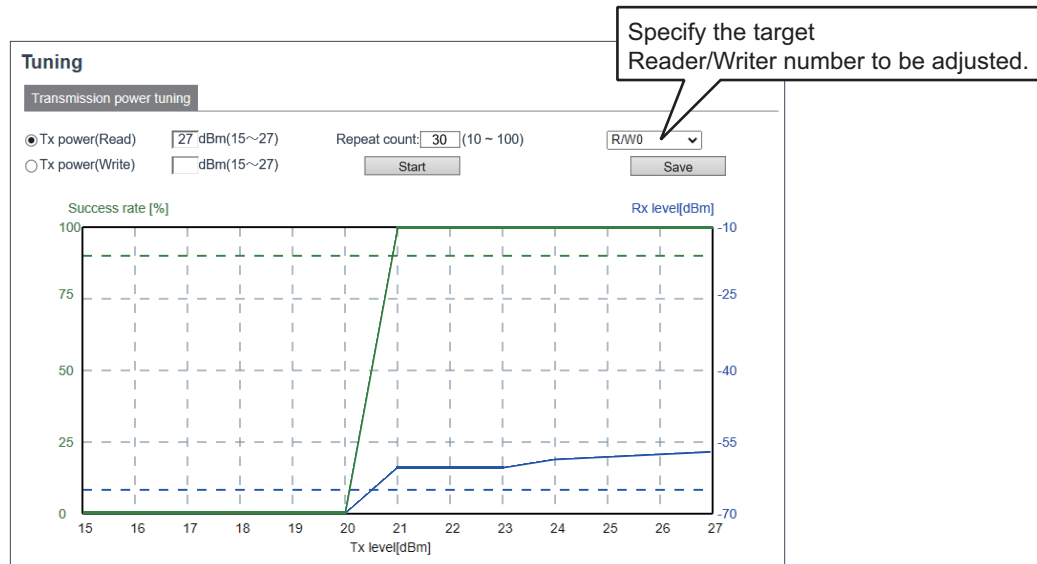

Reception level monitor for Multiple Reader/Writers

You can use the Utilities View (click the **Utilities** Button and then click the **Reception level monitor** Tab) on the Web browser interface, to check the reception level separately for the master or slave Reader/Writer.

● Single-access

On the Reception Level Monitor Tab Page, specify the Reader/Writer numbers to be measured in the Reader/Writers on the Multi-Reader/Writer configuration.

Click the **Start** Button after specification will start measurement by the subject Reader/Writers.

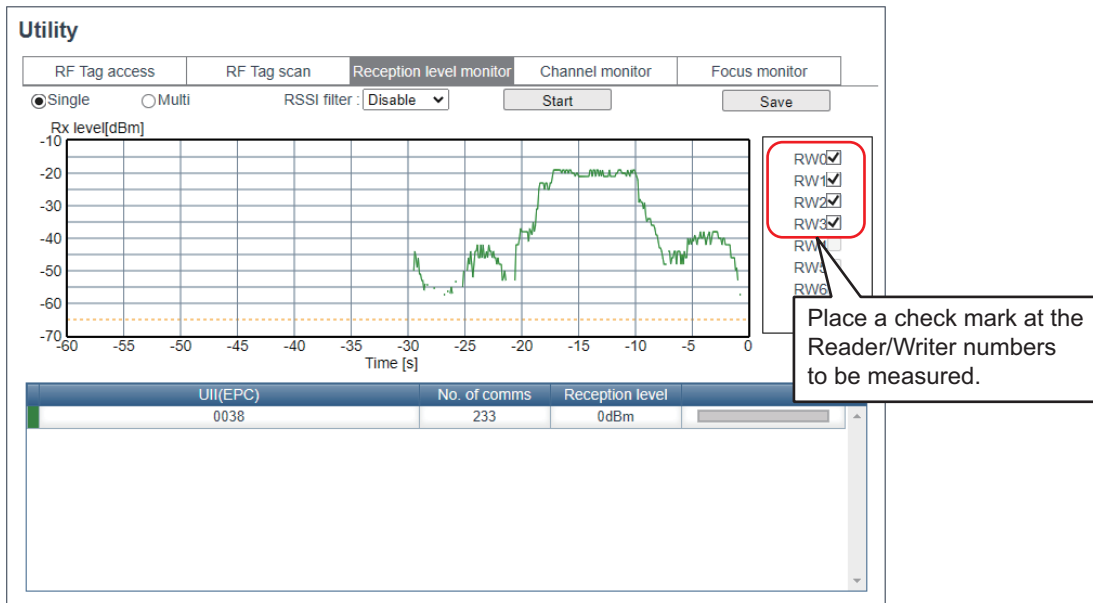

Reception Level Measurement Results

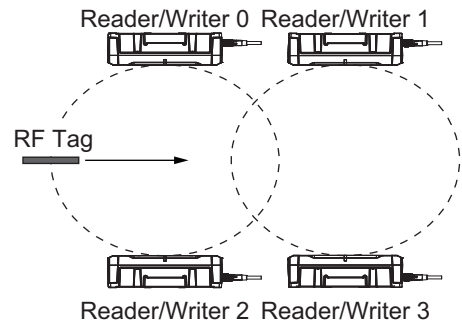
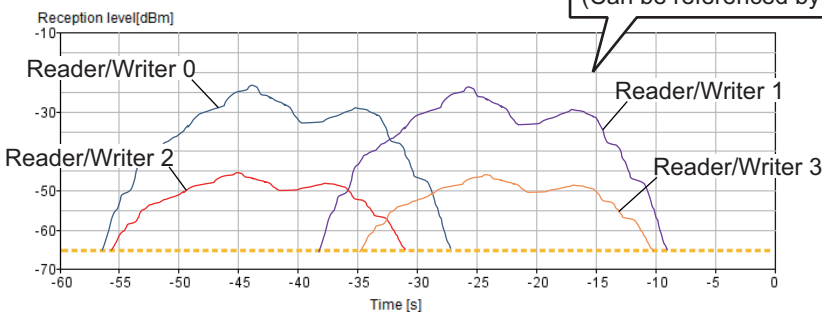

Graph Display on the Web Browser Interface

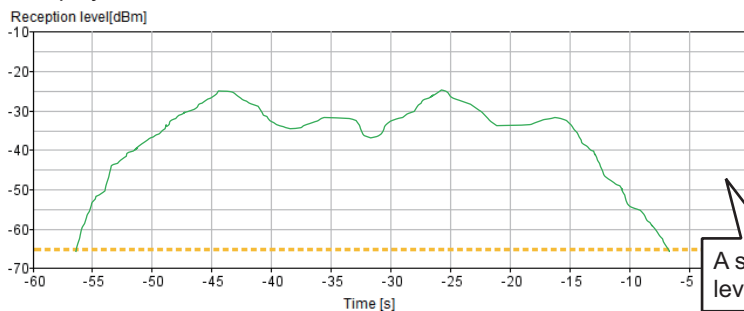

● **Multiaccess**

On the Reception Level Monitor Tab Page, specify the Reader/Writer numbers to be measured in the Reader/Writers on the Multi-Reader/Writer configuration.

Click the **Start** Button after specification will start measurement by the subject Reader/Writers.

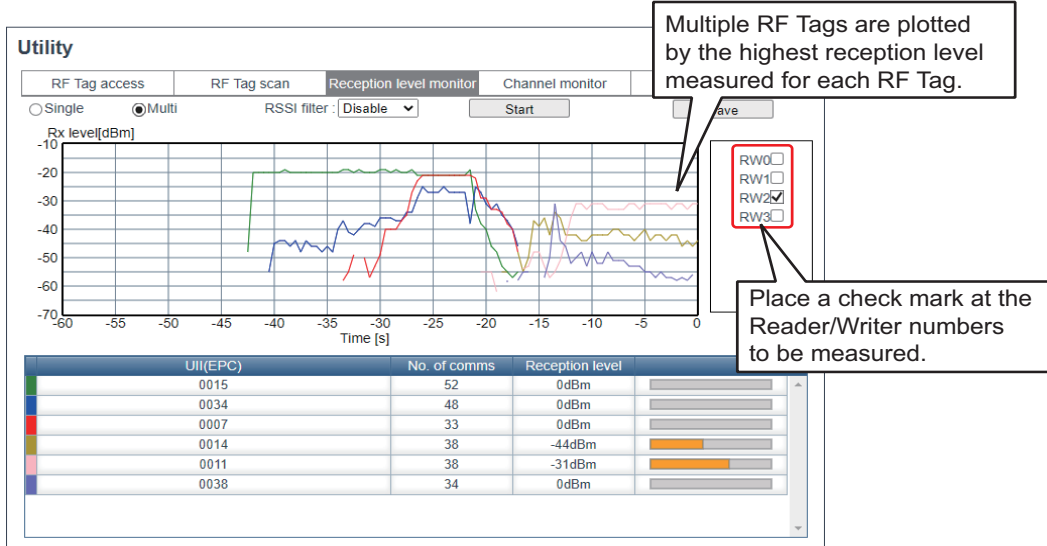

Reception Level Measurement Results

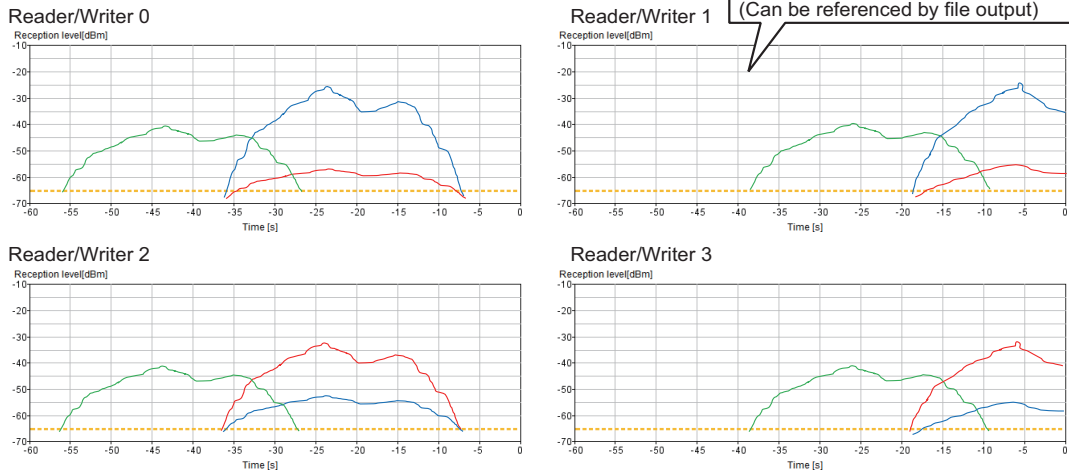

Graph Display on the Web Browser Interface

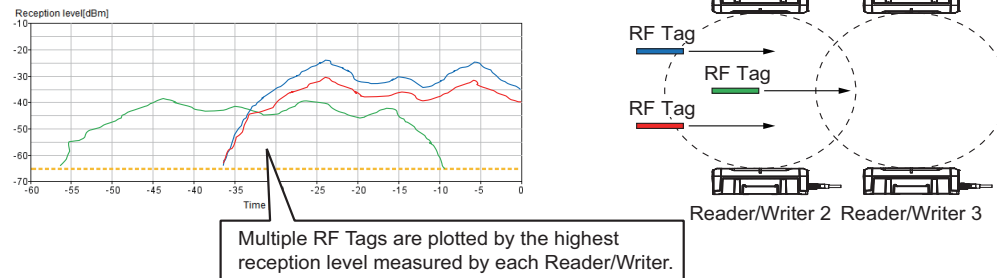

Channel monitor for Multiple Reader/Writers

You can use the Utilities View (click the **Utilities** Button and then click the **Channel monitor** Tab) on the Web browser interface, to check the channel settings separately for the master or slave Reader/Writer.

You can specify the target Reader/Writer number to monitor on the Channel monitor Tab Page.

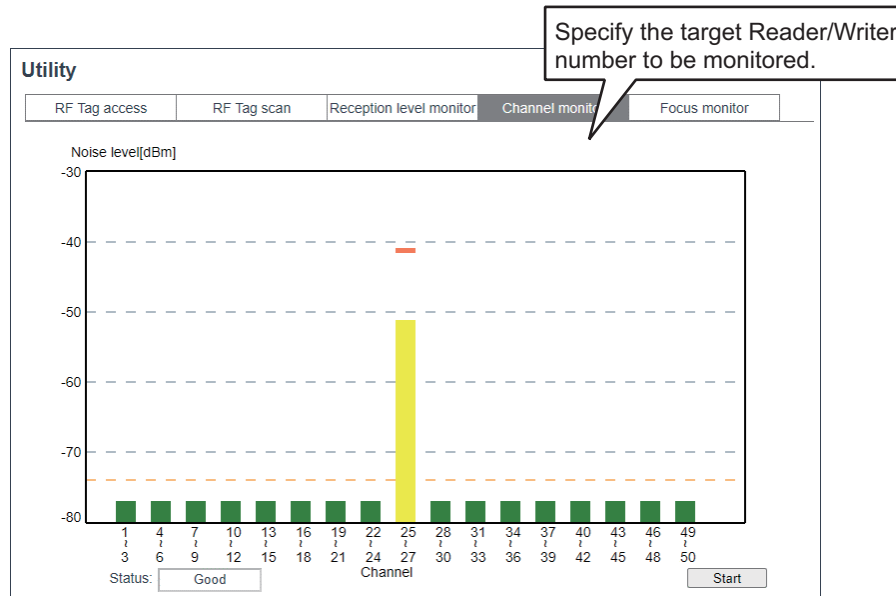

Command error log

If, with the Multi-Reader/Writer function enabled, the master Reader/Writer responds with a communications command error, the reader/writer number of the reader/writer where the error was detected is added and registered to the command error log. (For details, see the "Command Error Log" chapter)

Communications Diagnostics/RF Communications Diagnostics Log

With the Multi-Reader/Writer functions enabled, the Communications Diagnostics functions cannot be used as well.

Even if the communications diagnostic settings are enabled, diagnostic processing cannot be executed when executing communications commands.

7

Modbus/TCP Communications

This section provides an overview of Modbus/TCP communications and describes the communications format, communications commands, and communications procedure.

7-1	Outline	7-2
7-1-1	Modbus/TCP Communications	7-2
7-1-2	Modbus/TCP Function Codes Supported by the V780	7-3
7-1-3	Communications System	7-3
7-2	Message Formats	7-5
7-2-1	Command Format	7-5
7-2-2	Response Format for Normal Completion	7-6
7-2-3	Response Format for Error Completion	7-7
7-2-4	Read Multiple Registers Command/Response (FC03)	7-8
7-2-5	Write Multiple Registers Command/Response (FC16)	7-8
7-2-6	Expanded Command/Response (FC100)	7-9
7-3	RF Communications Command Options	7-10
7-4	Communications Procedure	7-12
7-4-1	Command Communications Procedure	7-12
7-4-2	Error Response Reception Procedure	7-13
7-4-3	RF Tag Communications Command Procedure for Single-access Communications	7-14
7-4-4	RF Tag Communications Command Procedure for Multiaccess Communications	7-16
7-5	Commands	7-19
7-6	V780 Command Details	7-22
7-6-1	Single-access Communications Commands	7-22
7-6-2	Multiaccess Communications Commands	7-34
7-6-3	Modbus Expansion Communications Commands	7-44
7-6-4	Reader/Writer Control Commands	7-52
7-6-5	Reader/Writer Setting Commands: Network Settings	7-57
7-6-6	Reader/Writer Setting Commands: Communications Settings	7-73
7-6-7	Reader/Writer Setting Commands: Device Settings	7-103
7-6-8	Maintenance Commands: Device Information	7-111
7-6-9	Maintenance Commands: Log Information	7-124
7-6-10	Maintenance Commands: RF Communications Information	7-131

7-1 Outline

7-1-1 Modbus/TCP Communications

- A V780 Reader/Writer can perform Modbus/TCP-compliant message communications with the host device (PLC).
- Communications between the host device (PLC) and the V780 Reader/Writer are performed on a client-server basis using the TCP/IP protocol. The computer, PLC, or other host device is the client and the Reader/Writer is the server.
- The message that the host device (PLC) sends to the Reader/Writer is called a command. The message that the Reader/Writer returns is called the response.

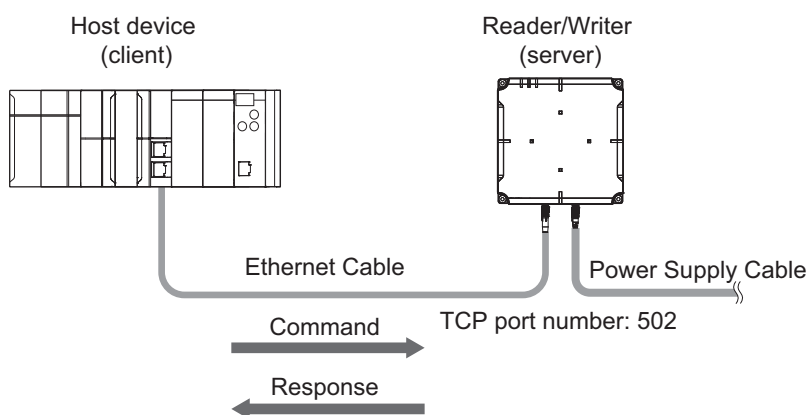

Precautions for Correct Use

The slave reader/writer (V780-HMD68-ETN-□□-S) disconnects the connection when it sends a communication command directly from the host device (client).

Use the slave reader/writer via the master reader/writer (V780-HMD68-ETN-□□).



Additional Information

Modbus/TCP Protocol

The Modbus/TCP protocol is a communications protocol developed for PLCs by Modicon Inc.(AEG Schneider Automation International S.A.S.). It is an open standard and has been used for a variety of industrial devices.

A query in Modbus/TCP communications is called a command in this manual.

7-1-2 Modbus/TCP Function Codes Supported by the V780

The Modbus/TCP function codes that are supported by the V780 Reader/Writer are given in the following table.

Function code	Description
FC03 and FC16 (normal commands)	<p>These function codes comply with Modbus/TCP Class 0.</p> <p>The basic Modbus/TCP function codes are classified in Class 0.</p> <p>Class 0 contains the following two functions: Read Multiple Registers (FC03) and Write Multiple Registers (FC16).</p> <p>These are called normal commands in this manual.</p>
FC100 (expanded command)	<p>This function code has a unique format that was defined by OMRON.</p> <p>This function code is used to reduce command/response exchanges between the host device and Reader/Writer and give priority to the performance of communications with the host device.</p> <p>This is called an expanded command in this manual.</p>

7-1-3 Communications System

There are two communications systems used by the V780 depending on the function codes that are used.

Modbus/TCP Communications System (FC03 and FC16)

The communications system that uses normal commands that are compliant with Modbus/TCP Class 0 is shown below.

Refer to 7-2 Message Formats on page 7-5 for details on the normal commands.

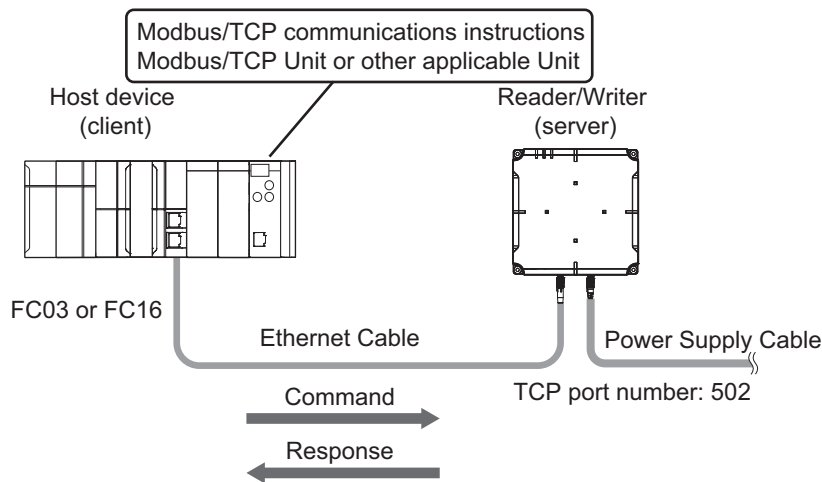

TCP/IP Socket Communications System (FC03, FC16, and FC100)

The expanded command that has a unique format defined by OMRON (FC100) cannot be sent with a Modbus/TCP Class 0-compliant protocol. The TCP/IP socket communications of the host device (PLC) are used instead.

Refer to *7-2 Message Formats* on page 7-5 for details on the expanded communications commands.

Refer to *7-4 Communications Procedure* on page 7-12 for information on creating a program for TCP/IP communications.

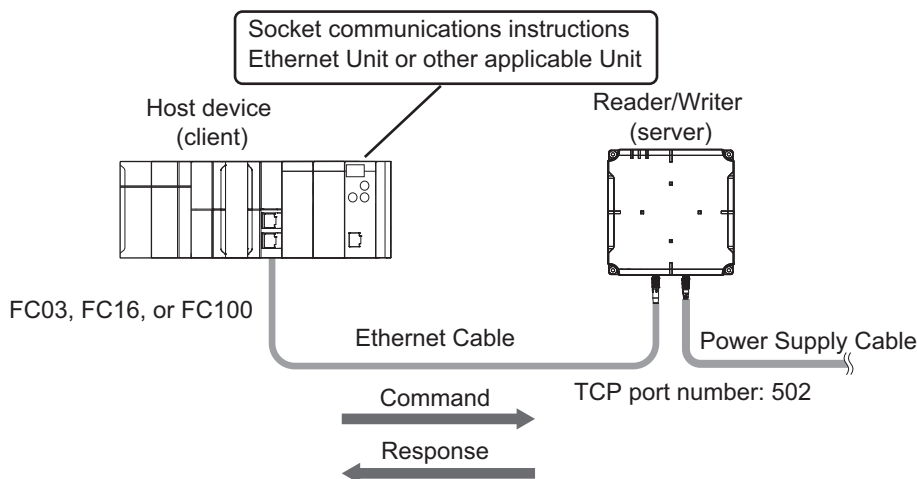

Precautions for Correct Use

Communications Units and communications commands that support the Modbus/TCP protocol support only function codes that comply with Modbus/TCP Class 0. Therefore, the function code FC100 for expanded commands cannot be used.

IP Address Settings of the Reader/Writer

You can set any IP address for the V780 Reader/Writer.

For details, refer to *7-6-5 Reader/Writer Setting Commands: Network Settings* on page 7-57 or *Setting the IP Address of the Reader/Writer from a Web Browser* on page 5-4.

Port Numbers Used for Modbus/TCP Communications

Normally, port number 502 (01F6 hex) is used for Modbus/TCP communications.

With the V780 Reader/Writer, you can change the port number to between 1,024 and 65,535 (0400 hex and FFFF hex).

For details, refer to *8-2-3 Network Settings* on page 8-6.



Precautions for Correct Use

The slave reader/writer (V780-HMD68-ETN-□□-S) can not change the Modbus/TCP port number(502) from the default

7-2 Message Formats

7-2-1 Command Format

Byte-0	Byte-1	Byte-2	Byte-3	Byte-4	Byte-5	Byte-6	Byte-7	Byte-8	Byte-9	...	Byte-n
Transaction identifier	Protocol identifier		Field length		Unit identifier	Function code	Data				
XXXX hex	Always 0000 hex.		XXXX hex		Always FF hex.	03 hex, 10 hex, or 64 hex	XX...XX hex				

X: Any value, n: 4,351 max.

Range included in the field length.

Command frame length

Transaction Identifier

This value is used to identify the message sent by the host device.

The transaction identifier in the response from the Reader/Writer will be a copy of the value that is specified here.

Protocol Identifier

This field is always 0000 hex.

Field Length

Specify the number of bytes inclusively from the unit identifier through the end of the data.

If the function code is FC03 or FC16, the maximum field length is 250 bytes.

If the function code is FC100, the maximum field length is 4,346 bytes.

Unit Identifier

This field is always FF hex.

Function Code

The function code indicates the command to request execution from the Reader/Writer.

Function code	Function	Remarks
FC03 (03 hex)	Read Multiple Registers	Modbus/TCP Class 0 compliant
FC16 (10 hex)	Write Multiple Registers	
FC100 (64 hex)	Reader/Writer command	This function code is used for commands with a unique manufacturer definition that gives priority to the performance of communications with the host device.

Data

Specify the data that is relevant to the function code.
The format of the data depends on the function code.

7-2-2 Response Format for Normal Completion

Byte-0	Byte-1	Byte-2	Byte-3	Byte-4	Byte-5	Byte-6	Byte-7	Byte-8	Byte-9	...	Byte-n
Transaction identifier	Protocol identifier		Field length		Unit identifier	Function code	Data				
XXXX hex	Always 0000 hex.		XXXX hex		Always FF hex.	03 hex, 10 hex, or 64 hex	XX...XX hex				

X: Any value, n: 9,215 max.

Range included in the field length.

Transaction Identifier

The value that was specified in the command is set.

Protocol Identifier

This field is always 0000 hex.

Field Length

The number of bytes inclusively from the unit identifier through the end of the data is set.

Unit Identifier

This field is always FF hex.

Function Code

The value of the function code that was specified in the command is set.

Data

The data that is relevant to the function code is set.
The format of the data depends on the function code.

7-2-3 Response Format for Error Completion

Byte-0	Byte-1	Byte-2	Byte-3	Byte-4	Byte-5	Byte-6	Byte-7	Byte-8
Transaction identifier		Protocol identifier		Field length		Unit identifier	Function code	Exception code
XXXX hex		Always 0000 hex.		Always 0003 hex.		Always FF hex.	83 hex, 90 hex, or E4 hex	XX hex

X: Any value

Range included in the field length.

Transaction Identifier

The value that was specified in the command is set.

Protocol Identifier

This field is always 0000 hex.

Field Length

This field is always 0003 hex.

Unit Identifier

This field is always FF hex.

Function Code

The value of the function code that was specified in the command plus 80 hex is set.

Exception Code

A code that provides information on the error is set.

You can use the error code to identify the error that was detected by the Reader/Writer. The exception code and error code are related as given below. Refer to the most recent command error information or command error log to check details on the error using the error code.

Exception code	Exception code meaning	V780 error code	
01 hex	Illegal function	1001 hex	Frame length error
		1002 hex	Frame header error
		1003 hex	Unknown command error
02 hex	Illegal data address	1004 hex	Command format error
03 hex	Illegal data value	1005 hex	Command parameter error

Exception code	Exception code meaning	V780 error code	
		Hex	Description
04 hex	Failure in slave device	2*** hex	RF Tag communications error
		1012 hex	Command execution failure (inappropriate operation mode)
		1013 hex	Command execution failure (inappropriate RF communications mode)
		1018 hex	Command execution failure, minor fault
		101F hex	Command execution failure, major fault
06 hex	Slave device busy	1011 hex	Command execution failure, busy

7-2-4 Read Multiple Registers Command/Response (FC03)

Command Format

Byte-7	Byte-8	Byte-9	Byte-10	Byte-11
Function code	Register address		Word count	
03 hex	XXXX hex		0001 to 0078 hex (1 to 120)	

Normal Response Format

Byte-7	Byte-8	Byte-9	...	Byte-n
Function code	Byte count	Read multiple registers data		
03 hex	XX hex	XX...XX hex		

7-2-5 Write Multiple Registers Command/Response (FC16)

Command Format

Byte-7	Byte-8	Byte-9	Byte-10	Byte-11	Byte-12	Byte-13	...	Byte-n
Function code	Register address		Word count		Byte count	Write multiple registers data		
10 hex	XXXX hex		0001 to 0078 hex (1 to 120)		Word count x 2	XX...XX hex		

Normal Response Format

Byte-7	Byte-8	Byte-9	Byte-10	Byte-11
Function code	Register address		Word count	
10 hex	XXXX hex		0001 to 0078 hex (1 to 120)	

7-2-6 Expanded Command/Response (FC100)

Command Format

Byte-7	Byte-8	Byte-9	Byte-10	...	Byte-n
Function code	Subfunction code		Expanded command parameters		
64 hex	XXXX hex		XX...XX hex		

Normal Response Format

Byte-7	Byte-8	Byte-9	Byte-10	...	Byte-n
Function code	Subfunction code		Expanded response data		
64 hex	XXXX hex		XX...XX hex		

7-3 RF Communications Command Options

This section describes the options that you can use together with RF communications commands (multiaccess or Modbus expansion). You can specify options to get the UII (EPC) of the RF Tag, the reception level, or other communications information together with the normal data for the command.

For commands with the multiaccess specification, the communications information specified with the option is returned in the response for the command that gets the execution results, i.e., the two commands are used together.

For commands with the Modbus expansion, the communications information specified with the option is returned as an attachment to the response.

Options

● Options

Item	Relevant bit	Description	Information size
UII (EPC)	Bit 0	The StoredPC and UII (EPC code) are attached.	32 words
Reception level	Bit 1	The reception level (signed hexadecimal) is attached. FFFF to FF9D hex (-1 to -99 [dBm]) • A value of 0 will be set if processing ended in an error.	1 word
Reserved 1	Bits 2 to 3	• These bits are reserved.	---
Diagnostic result	Bit 4	The diagnostic results (4-digit hexadecimal) are attached. If communications diagnostics are disabled, 0000 hex is attached. For details, refer to <i>Response Formats</i> on page 7-136 under <i>GET COMMUNICATIONS DIAGNOSTIC INFORMATION</i> on page 7-136.	1 word
Reader/Writer Number	Bit 5	This adds the Reader/Writer number (4 hexadecimal digits) of the reader/writer communicating with the RF Tag. 0000 hex to 0007 hex	1 word
Reserved 2	Bits 6 to 15	• These bits are reserved.	---

Option Specification Examples:

Specify 0001 hex to have the UII (EPC) attached.

Specify 0003 hex to have the UII (EPC) and reception level attached.

Specify 0011 hex to have the UII (EPC) and diagnostic results attached.

● Options Supported by RF Communications Commands

OK: Option can be specified, No: Option cannot be specified. (A parameter error will occur if it is.)

---: Reserved (Always specify 0 for these unused bits.)

Classification	Command	Options				
		Reserved	Diagnostic results	Reserved	RSSI	UII (EPC)
		Bits 5 to 15	Bit 4	Bits 2 and 3	Bit 1	Bit 0
Communications command, multi-access	SET MULTIACCESS ID READ	---	No	---	OK	No
	SET MULTIACCESS DATA READ	---	No	---	OK	OK
Communications command, Modbus expansion	EXTENDED DATA READ	---	OK	---	OK	OK
	EXTENDED DATA WRITE	---	OK	---	OK	OK
	EXTENDED MULTIACCESS ID READ	---	No	---	OK	No
	EXTENDED MULTIACCESS DATA READ	---	No	---	OK	OK

7-4 Communications Procedure

In the computer, PLC, or other host devices, write the program to communicate with the Reader/Writer using TCP sockets.

If you use an Modbus/TCP master device, follow the communications procedure for the device you are using.

7-4-1 Command Communications Procedure

A connection is required between the host device and Reader/Writer to communicate with the Reader/Writer. After you establish a connection, send commands and receive the responses.

- 1** Connection Processing: Opening a Socket
Send a request for a connection from the host device to the Reader/Writer and establish a TCP connection. Monitor for connection timeouts as required.
- 2** Command Send Processing: Sending Socket Data
Send the command from the host device to the Reader/Writer in a message.
Monitor for send timeouts as required.
- 3** Response Reception Processing: Receiving Socket Data
At the host device, wait to receive the message from the host device and receive the response.
Monitor for reception timeouts as required.
- 4** Disconnection Processing: Closing the Socket
Send a request for a disconnection from the host device to the Reader/Writer and disconnect the TCP connection. Monitor for disconnection timeouts as required.

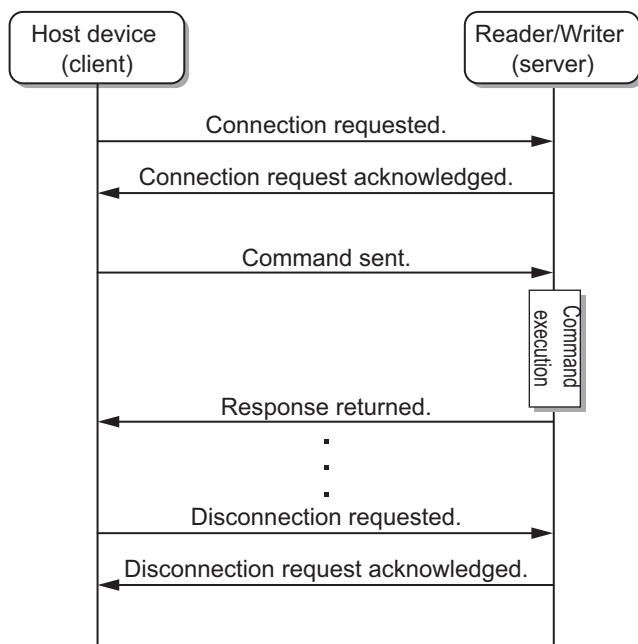



Precautions for Correct Use

Access to a Reader/Writer is possible from only one host device at a time.

If a host device B connects to a Reader/Writer while another host device A is already connected to it, the connection between host device A and the Reader/Writer will be automatically disconnected and a connection with host device B will be established.

7-4-2 Error Response Reception Procedure

If an error response is received, you can check the most recent command error information or command error log in the Reader/Writer to get details on the nature of the error. An error has occurred if the function code in the response that was returned from the Reader/Writer is 80 hex higher than the function code in the query.

You can do this by sending a GET MOST RECENT ERROR INFORMATION command or GET COMMAND ERROR LOG command from the host device or by using the Web browser interface through the Web browser interface.

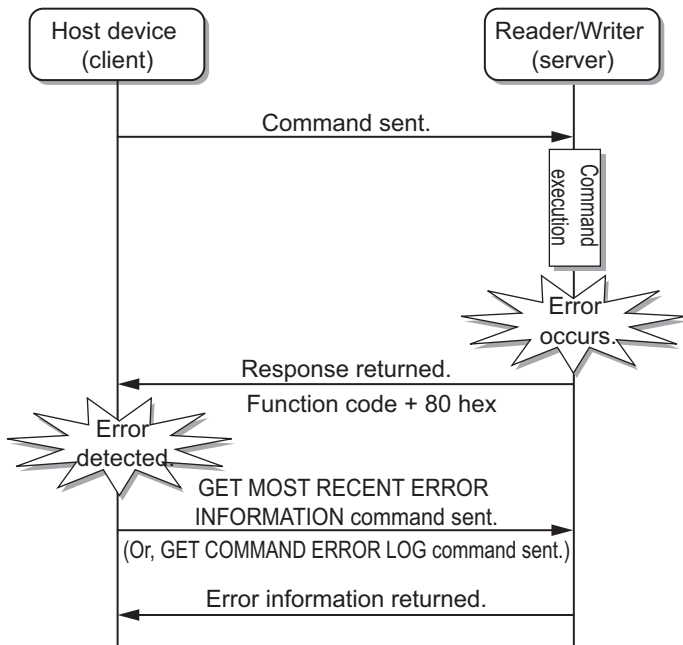

7-4-3 RF Tag Communications Command Procedure for Single-access Communications

When you send an RF Tag communications command with single-access communications, the Reader/Writer communicates with only one RF Tag in the communications range.

Using a Normal Command (FC03 or FC16)

With a normal command, the maximum size of data that you can read from an RF Tag is 120 words. To read more data than that, you must use more than one DATA READ or DATA WRITE command, or use an expanded command.

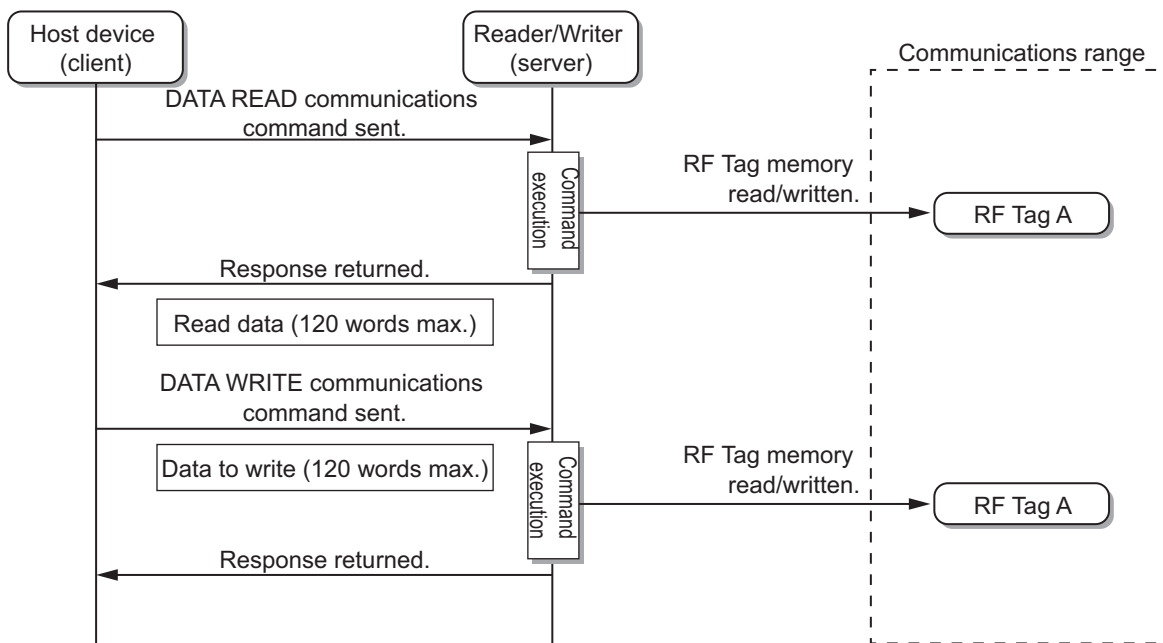

If communications with an RF Tag are not possible, a “failure in slave device” exception code (04 hex) is returned in an error response. Following the error response reception procedure.

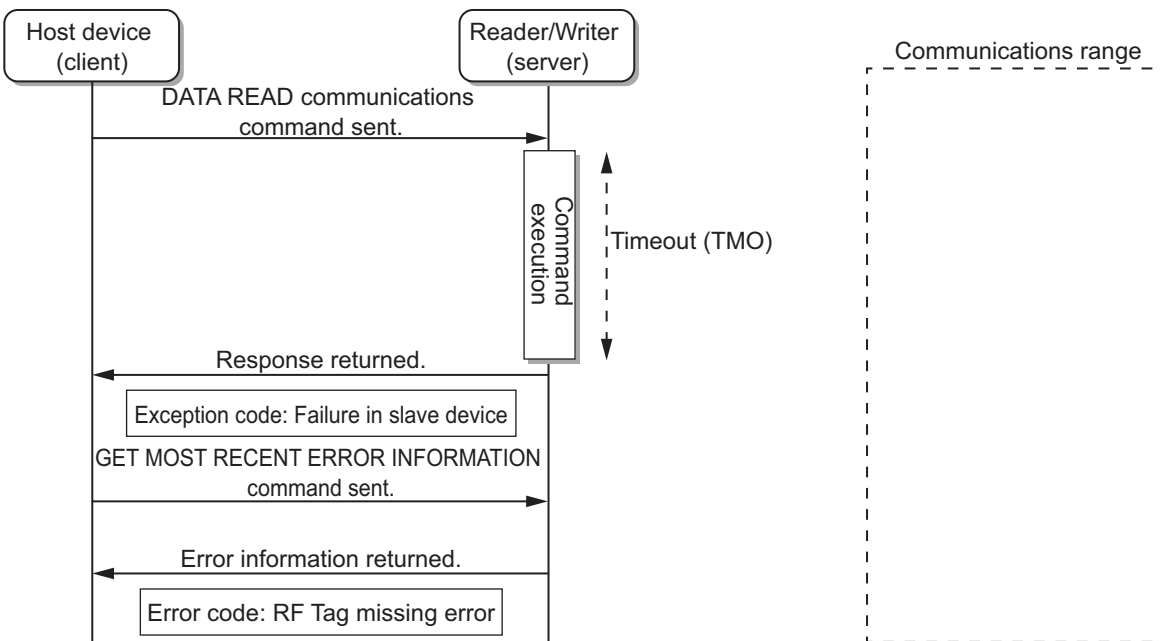

If you want to check the EPC code or reception level when communications with the RF Tag are successful, send a GET RF TAG ADDITIONAL INFORMATION command after the response to the communications command has been received. The reception level from the RF Tag that was just communicated with will be returned.

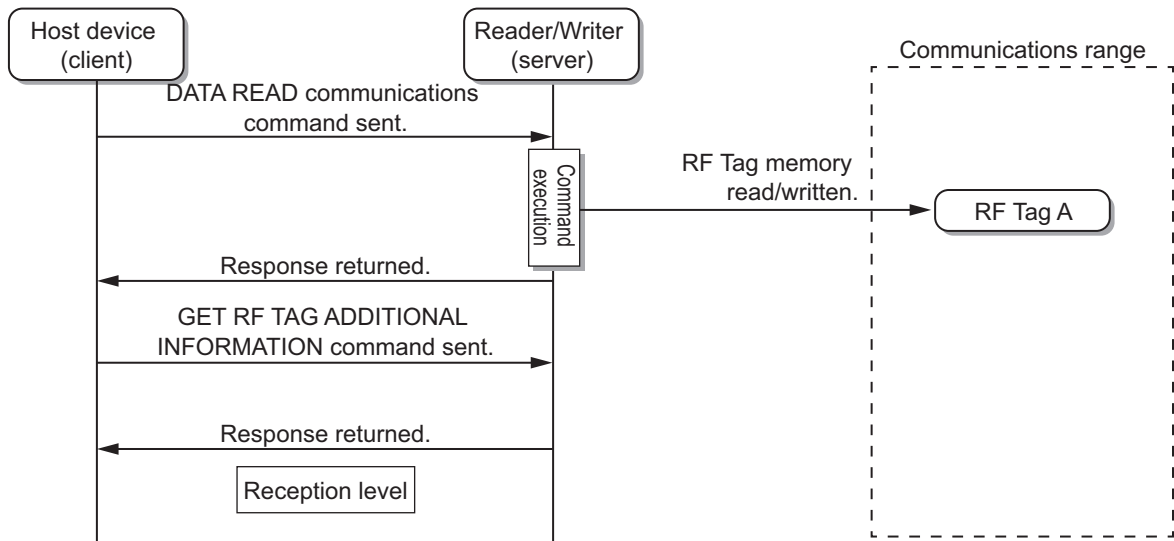

Using an Expanded Command (FC100)

With an expanded command, the maximum size of data that you can read from an RF Tag is 2,048 words.

If an error occurs in the RF Tag communications, the error code is returned with the response. No additional command is required to check the error code.

You can also specify a command option to have the UII (EPC code) or reception level returned with the other data.

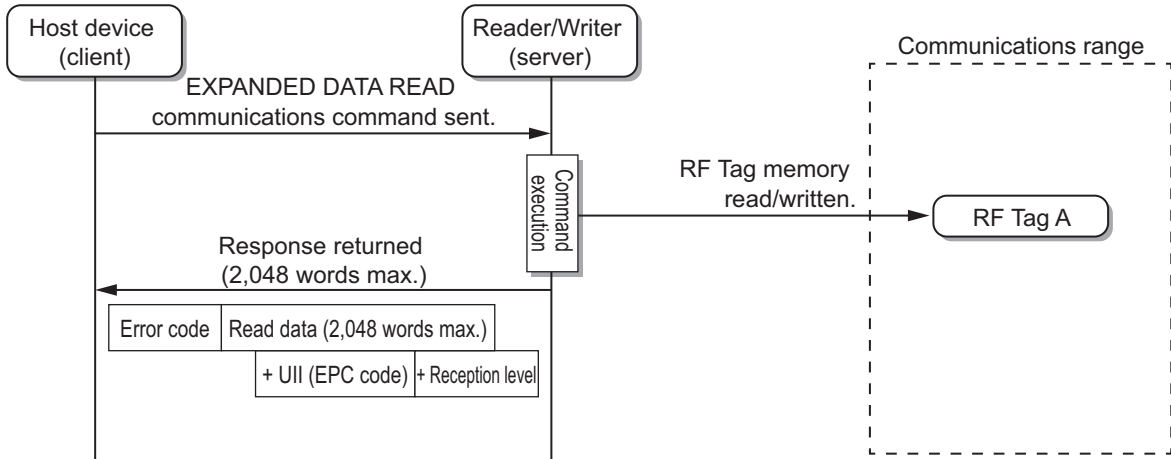

7-4-4 RF Tag Communications Command Procedure for Multiaccess Communications

When you send an RF Tag communications command with multiaccess communications, the Reader/Writer communicates with more than one RF Tag in the communications range.

The Reader/Writer will communicate with all of the RF Tags in the communications range within the communications timeout time (64 max.) and then return a response.

Using a Normal Command (FC03 or FC16)

With a normal multiaccess RF Tag command, two commands are used to exchange the data, one to set communications and another to get the results.

1 Sending the Command to Set Communications

First, send the command to set communications.

If the Reader/Writer detects even one RF Tag, the results of execution are returned as a normal response.

If no RF Tags were detected, an RF Tag missing error is returned.

2 Sending the Command to Get the Results

Send the command to get the results.

When you execute the command to get the results, the results of communications with the first RF Tag that was detected will be returned. The communications results will contain the number of RF Tags detected, the error code, and, for DATA READ, the UII (EPC code).

If the option is specified, the reception level information is also attached.

3 Repeatedly Getting the Results

Execute the command to get the results once for every RF Tag that was detected.

The number of RF Tags that was detected by the Reader/Writer is included in the response to the command to get the results. Repeatedly send the command until the number of RF Tags in the response is 1.

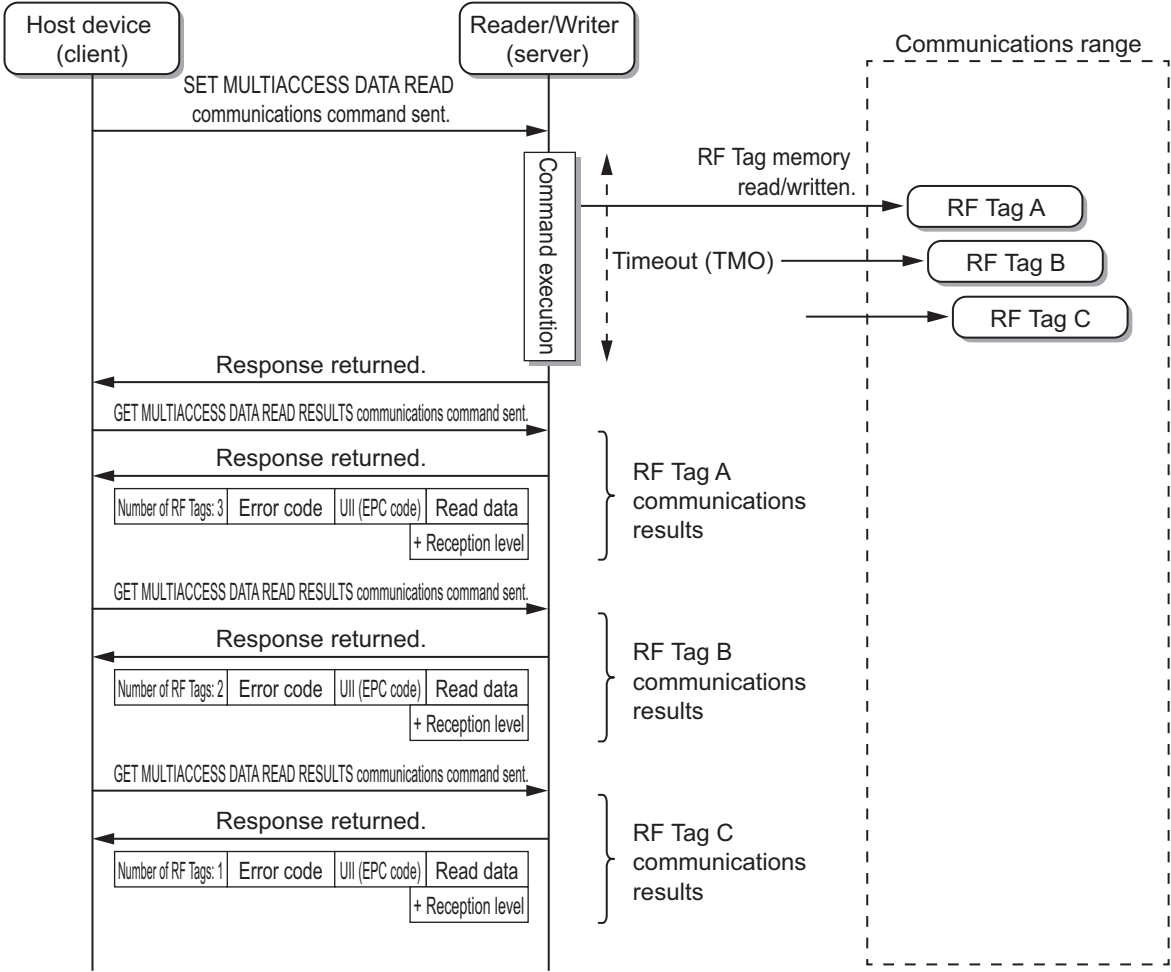

Precautions for Correct Use

If you execute another communications command (e.g., a single-access read, write, or fill command or a multiaccess read command) before you execute the commands to get the results, the multiaccess communications results held in the Reader/Writer will be cleared.

Using an Expanded Command (FC100)

With an expanded command, you can execute one multiaccess RF Tag command to get the communications results from more than one RF Tag with only one command.

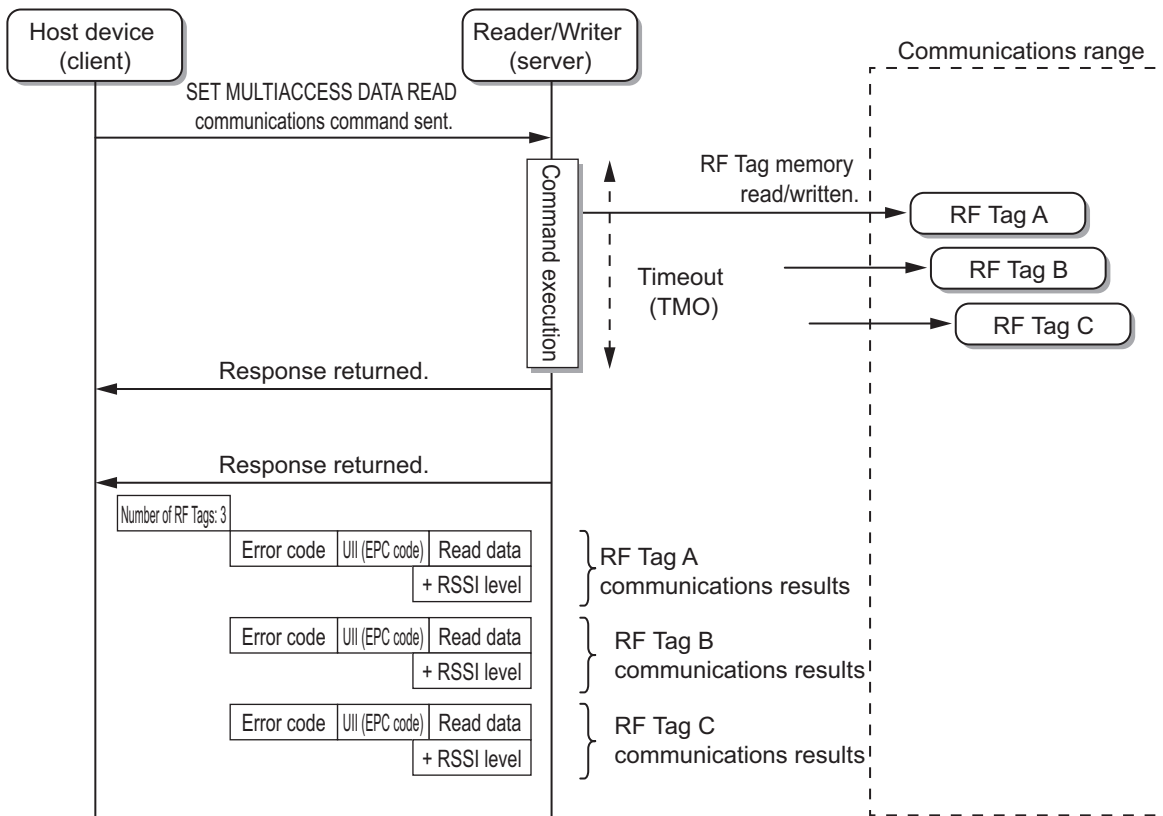

Precautions for Correct Use

The normal MULTIACCESS DATA READ and MULTIACCESS ID READ communications commands are designed for applications that read two to five RF Tags at one time. If your application requires reading more RF Tags than that, we recommend that you use an expanded command.

7-5 Commands

The commands that you can send to a Reader/Writer are listed below.

The command codes are used to identify the commands and they are recorded in the most recent command error information and command error log with an error response is returned. (This information is not included in the Modbus/TCP message format.)

Single-access Communications Commands

Command name	Function code	Register address	Command code
ID READ	FC03	4000 hex	0001 hex
ID WRITE	FC16	4000 hex	0002 hex
DATA READ	FC03	0000 to 07FF hex 1000 to 17FF hex 2000 to 27FF hex 3000 to 3FFF hex	0003 hex
DATA WRITE	FC16	0000 to 07FF hex 1000 to 17FF hex 2000 to 27FF hex 3000 to 3FFF hex	0004 hex
LOCK	FC16	8000 hex	0005 hex
DATA FILL	FC16	8100H hex	0006 hex

Multiaccess Communications Commands

Command name	Function code	Register address	Command code
SET MULTIACCESS ID READ	FC16	Always 9000 hex.	0101 hex
GET MULTIACCESS ID READ RESULTS	FC03	Always 9100 hex.	0102 hex
SET MULTIACCESS DATA READ	FC16	Always 9200 hex.	0103 hex
GET MULTIACCESS DATA READ RESULTS	FC03	Always 9300 hex.	0104 hex

Modbus Expansion Communications Commands

Command name	Function code	Subfunction code	Command code
EXTENDED DATA READ	FC100	0001 hex	0201 hex
EXTENDED DATA WRITE	FC100	0002 hex	0202 hex
EXTENDED MULTIACCESS ID READ	FC100	0003 hex	0203 hex
EXTENDED MULTIACCESS DATA READ	FC100	0004 hex	0204 hex

Reader/Writer Control Commands

Command name	Function code	Register address	Command code
INITIALIZE	FC16	A000 hex	1001 hex
RESET	FC16	A100 hex	1002 hex
STOP	FC16	A200 hex	1003 hex
RESET FOCUS	FC16	A300 hex	1004 hex

Reader/Writer Setting Commands: Network Settings

Command name	Function code	Register address	Command code
SET TCP/IP COMMUNICATIONS CONDITIONS	FC16	B000 hex	2001 hex
GET TCP/IP COMMUNICATIONS CONDITIONS	FC03	B000H hex	2002 hex
SET DEVICE NAME	FC16	B100 hex	2003 hex
GET DEVICE NAME	FC03	B100 hex	2004 hex
SET MODBUS/TCP COMMUNICATIONS CONDITIONS	FC16	B200 hex	2005 hex
GET MODBUS/TCP COMMUNICATIONS CONDITIONS	FC03	B200 hex	2006 hex
SET WEB COMMUNICATIONS CONDITIONS	FC16	B300 hex	2007 hex
GET WEB COMMUNICATIONS CONDITIONS	FC03	B300 hex	2008 hex
SET WEB PASSWORD	FC16	B400 hex	2009 hex
GET WEB PASSWORD	FC03	B400 hex	200A hex

Reader/Writer Setting Commands: Device Settings

Command name	Function code	Register address	Command code
SET OPERATION INDICATOR CUSTOM CONDITIONS	FC16	B800 hex	5001 hex
GET OPERATION INDICATOR CUSTOM CONDITIONS	FC03	B800 hex	5002 hex
SET MULTI-READER/WRITER CONFIGURATION	FC16	B900 hex	5003 hex
GET MULTI-READER/WRITER CONFIGURATION	FC03	B900 hex	5004 hex

Reader/Writer Setting Commands: Communications Settings

Command name	Function code	Register address	Command code
SET TAG COMMUNICATIONS CONDITIONS	FC16	C000 hex	3001 hex
GET TAG COMMUNICATIONS CONDITIONS	FC03	C000 hex	3002 hex
SET TRANSMISSION POWER	FC16	C100 hex	3003 hex
GET TRANSMISSION POWER	FC03	C100 hex	3004 hex
SET CHANNEL	FC16	C200Hex	3005 hex
GET CHANNEL	FC03	C200Hex	3006 hex
SET GEN2 SESSION	FC16	C300 hex	3007 hex
GET GEN2 SESSION	FC03	C300 hex	3008 hex
SET ACCESS PASSWORD	FC16	C400 hex	3009 hex
GET ACCESS PASSWORD	FC03	C400 hex	300A hex
SET RF TAG SELECTION FILTER CONDITIONS	FC16	C500 hex	300B hex
GET RF TAG SELECTION FILTER CONDITIONS	FC03	C500 hex	300C hex
SET RSSI FILTER CONDITIONS	FC16	C600 hex	300D hex
GET RSSI FILTER CONDITIONS	FC03	C600 hex	300E hex
SET TRANSMISSION TIME	FC16	C700 hex	300F hex
GET TRANSMISSION TIME	FC03	C700 hex	3010 hex

Maintenance Commands: Device Information

Command name	Function code	Register address	Command code
GET MODEL INFORMATION	FC03	D000 hex	4001 hex
GET FIRMWARE VERSION	FC03	D100 hex	4002 hex
GET MAC ADDRESS	FC03	D200 hex	4003 hex
GET OPERATING STATUS	FC03	D300 hex	4004 hex
GET TIME INFORMATION	FC03	D400 hex	4005 hex
SET TIME INFORMATION	FC16	D400 hex	4006 hex
GET MULTI-READER/WRITER STATUS	FC03	D500 hex	4007 hex

Maintenance Commands: Log Information

Command name	Function code	Register address	Command code
GET SYSTEM ERROR LOG	FC03	D600 hex	4101 hex
CLEAR SYSTEM ERROR LOG	FC16	D700 hex	4102 hex
GET COMMAND ERROR LOG	FC03	D800 hex	4103 hex
GET MOST RECENT COMMAND ERROR INFORMATION	FC03	D900 hex	4104 hex

Maintenance Commands: RF Communications Information

Command name	Function code	Register address	Command code
GET RF TAG ADDITIONAL INFORMATION	FC03	DA00 hex	4201 hex
GET NOISE LEVEL	FC03	DB00 hex	4202 hex
GET COMMUNICATIONS DIAGNOSTIC INFORMATION	FC03	DC00 hex	4203 hex

7-6 V780 Command Details

7-6-1 Single-access Communications Commands

ID READ

● Function

This command reads the ID (i.e., the UII (EPC code)) of the RF Tag in the communications range.

● Command Format

Byte-0	Byte-1	Byte-2	Byte-3	Byte-4	Byte-5	Byte-6	Byte-7	Byte-8	Byte-9	Byte-10	Byte-11
Transaction identifier		Protocol identifier		Field length		Unit identifier	Function code	Register address		Word count	
X	X	0000 hex		0006 hex		FF hex	03 hex	4000 hex		0020 hex	

Parameter	Description
Register address	The register address (4000 hex) that specifies reading the ID
Word count	The number of words in the read StoredPC and UII (EPC code) (always 0020 hex).

● Response Formats

- Normal Response

Byte-0	Byte-1	Byte-2	Byte-3	Byte-4	Byte-5	Byte-6	Byte-7	Byte-8	Byte-9	Byte-10
Transaction identifier		Protocol identifier		Field length		Unit identifier	Function code	Byte count	StoredPC	
X	X	0000 hex		0043 hex		FF hex	03 hex	40 hex	2 bytes	

Byte-11	...	Byte-72
UII (EPC code)		
62 bytes		

Parameter	Description
StoredPC	Gives the StoredPD data in 4-digit hexadecimal. The upper 5 bits are the UII (EPC code) word length. (Refer to <i>StoredPC Bit Format</i> on page 22, below.)
UII (EPC code)	Gives the Tag-specific information according to Gen2 standards. All bytes of the UII (EPC code) section that exceed the UII (EPC code) word length in the StoredPC are filled with 00 hex.

Note If the reception level is required, use *GET RF TAG ADDITIONAL INFORMATION* on page 7-131.



Additional Information

- StoredPC Bit Format

10	11	12	13	14	15	16	17	18	19	1A	1B	1C	1D	1E	1F
PC + UII (EPC) length 16 x (n + 1)					RFU		0:EPS 1:AFI	Data							

- Error Response

Byte-0	Byte-1	Byte-2	Byte-3	Byte-4	Byte-5	Byte-6	Byte-7	Byte-8
Transaction identifier		Protocol identifier		Field length		Unit identifier	Function code	Exception code
X	X	0000 hex		0003 hex		FF hex	83 hex	1 byte

Parameter	Description
Exception code	For details, refer to <i>Exception Code</i> on page 7-7 under <i>Response Format for Error Completion</i> on page 7-7.

- Execution Examples

Reading the ID Data from the RF Tag

Example 1: Execution When an RF Tag Is in the Communications Range (StoredPC: 3000 hex, UII (EPC code): 111122223333444455556666 hex)

TX: 000000000006FF0340000020

RX: 000000000043FF0340300011112222333344445555666600...00

* Words 7 through 31 of the UII (EPC code) section (i.e., the words past the EPC length of 6 words) are filled with zeros.

Example 2: Execution When an RF Tag Is Not in the Communications Range (Exception Code: 04 Hex (Failure in Device))

TX: 000000000006FF0340000020

RX: 000000000003FF8304

ID WRITE

● Function

This command writes the ID (i.e., the UII (EPC code)) to the RF Tag in the communications range.

● Command Format

Byte-0	Byte-1	Byte-2	Byte-3	Byte-4	Byte-5	Byte-6	Byte-7	Byte-8	Byte-9	Byte-10	Byte-11
Transaction identifier		Protocol identifier		Field length		Unit identifier	Function code	Register address		Word count	
X	X	0000 hex		2 bytes		FF hex	10 hex	4000 hex		2 bytes	

Byte-12	Byte-13	Byte-14	Byte-15	...	Byte-n
Byte count	UII (EPC) length		UII (EPC code)		
1 byte	2 bytes		0 to 62 bytes		

Parameter	Description
Field length	Setting range: 0015 to 0047 hex
Register address	The register address (4000 hex) that specifies reading or writing the ID
Word count	Setting range: 0001 to 0020 hex
Byte count	Setting range: 02 to 40 hex
UII (EPC) length	Gives the word size of the UII (EPC code) in 4-digit hexadecimal. 0000 to 001F hex (0 to 32)
UII (EPC code)	Gives the Tag-specific information according to Gen2 standards.

● Response Formats

• Normal Response

Byte-0	Byte-1	Byte-2	Byte-3	Byte-4	Byte-5	Byte-6	Byte-7	Byte-8	Byte-9	Byte-10	Byte-11
Transaction identifier		Protocol identifier		Field length		Unit identifier	Function code	Register address		Word count	
X	X	0000 hex		0006 hex		FF hex	10 hex	2 bytes		2 bytes	

Parameter	Description
Register address	The register address from the command is set.
Word count	The word count from the command is set.

Note If the reception level is required, use *GET RF TAG ADDITIONAL INFORMATION* on page 7-131.

• Error Response

Byte-0	Byte-1	Byte-2	Byte-3	Byte-4	Byte-5	Byte-6	Byte-7	Byte-8
Transaction identifier		Protocol identifier		Field length		Unit identifier	Function code	Exception code
X	X	0000 hex		0003 hex		FF hex	90 hex	1 byte

Parameter	Description
Exception code	For details, refer to <i>Exception Code</i> on page 7-7 under <i>Response Format for Error Completion</i> on page 7-7.

- **Execution Examples**

Writing the ID Data UII (EPC) to an RF Tag (EPC Length: 0006 Hex, UII (EPC code):
111122223333444455556666 Hex)

TX: 000000000015FF10400000070E0006111122223333444455556666

RX: 000000000006FF1040000007

DATA READ

● Function

This command reads data from the RF Tag in the communications range.

● Command Format

Byte-0	Byte-1	Byte-2	Byte-3	Byte-4	Byte-5	Byte-6	Byte-7	Byte-8	Byte-9	Byte-10	Byte-11
Transaction identifier		Protocol identifier		Field length		Unit identifier	Function code	Register address		Word count	
X	X	0000 hex		0006 hex		FF hex	03 hex	2 bytes		2 bytes	

Parameter	Description
Register address	Specify in 4-digit hexadecimal the start address for reading data. Setting ranges (word address specifications) 0000 to 07FF hex: Reserved area 1000 to 17FF hex: UII (EPC) area 2000 to 27FF hex: TID area 3000 to 3FFF hex: User area
Word count	Specify in 4-digit hexadecimal the number of words of data to read. Setting range: 0001 to 0078 hex (1 to 120)

● Response Formats

• Normal Response

Byte-0	Byte-1	Byte-2	Byte-3	Byte-4	Byte-5	Byte-6	Byte-7	Byte-8	Byte-9	...	Byte-n
Transaction identifier		Protocol identifier		Field length		Unit identifier	Function code	Byte count	Read data		
X	X	0000 hex		00 hex	1 byte	FF hex	03 hex	1 byte	2 to 240 bytes		

Parameter	Description
Byte count	Contains the number of bytes of data that were read from the RF Tag in 2-digit hexadecimal. (02 to F0 hex)
Read data	The data that was read from the RF Tag is attached.

Note If the reception level is required, use *GET RF TAG ADDITIONAL INFORMATION* on page 7-131.

• Error Response

Byte-0	Byte-1	Byte-2	Byte-3	Byte-4	Byte-5	Byte-6	Byte-7	Byte-8
Transaction identifier		Protocol identifier		Field length		Unit identifier	Function code	Exception code
X	X	0000 hex		0003 hex		FF hex	83 hex	1 byte

Parameter	Description
Exception code	For details, refer to <i>Exception Code</i> on page 7-7 under <i>Response Format for Error Completion</i> on page 7-7.

- **Execution Examples**

Reading Four Words of Data (1111222233334444 Hex) Starting from Word Address 0123 Hex (User Area) in the RF Tag

TX: 000000000006FF0331230004

RX: 00000000013FF03081111222233334444

DATA WRITE

● Function

This command writes data to the RF Tag in the communications range.

● Command Format

Byte-0	Byte-1	Byte-2	Byte-3	Byte-4	Byte-5	Byte-6	Byte-7	Byte-8	Byte-9	Byte-10	Byte-11
Transaction identifier		Protocol identifier		Field length		Unit identifier	Function code	Register address		Word count	
X	X	0000 hex		2 bytes		FF hex	10 hex	2 bytes		2 bytes	

Byte-12	Byte-13	...	Byte-n
Byte count	Data to write		
1 byte	1 to 120 words		

Parameter	Description
Field length	Setting range: 0009 to 00F7 hex (9 to 247)
Register address	Specify in 4-digit hexadecimal the start address for writing data in the RF Tag. Setting ranges (word address specifications) 0000 to 07FF hex: Reserved area 1000 to 17FF hex: Ull (EPC) area 2000 to 27FF hex: TID area 3000 to 3FFF hex: User area
Word count	Specify in 4-digit hexadecimal the number of words of data to write. Setting range: 0001 to 0078 hex (120 words max.)
Byte count	Specify in 4-digit hexadecimal the number of bytes of data to write. Setting range: 02 to F0 hex (240 bytes max.)
Data to write	Specify the data to write to RF Tag. Between 1 and 120 words of data can be written with one command.

● Response Formats

• Normal Response

Byte-0	Byte-1	Byte-2	Byte-3	Byte-4	Byte-5	Byte-6	Byte-7	Byte-8	Byte-9	Byte-10	Byte-11
Transaction identifier		Protocol identifier		Field length		Unit identifier	Function code	Register address		Word count	
X	X	0000 hex		0006 hex		FF hex	10 hex	2 bytes		2 bytes	

Parameter	Description
Register address	The register address from the command is set
Word count	The word count from the command is set.

Note If the reception level is required, use *GET RF TAG ADDITIONAL INFORMATION* on page 7-131.

• Error Response

Byte-0	Byte-1	Byte-2	Byte-3	Byte-4	Byte-5	Byte-6	Byte-7	Byte-8
Transaction identifier		Protocol identifier		Field length		Unit identifier	Function code	Exception code
X	X	0000 hex		0003 hex		FF hex	90 hex	1 byte

Parameter	Description
Exception code	For details, refer to <i>Exception Code</i> on page 7-7 under <i>Response Format for Error Completion</i> on page 7-7.

● Execution Examples

Writing Four Words of Data (1111222233334444 Hex) Starting from Word Address 0123 Hex (User Area) in the RF Tag

TX: 000000000000FF1031230004081111222233334444

RX: 0000000000006FF1031230004

LOCK

● Function

This command locks or unlocks the memory of the RF Tag in the communications range.

● Command Format

Byte-0	Byte-1	Byte-2	Byte-3	Byte-4	Byte-5	Byte-6	Byte-7	Byte-8	Byte-9	Byte-10	Byte-11
Transaction identifier		Protocol identifier		Field length		Unit identifier	Function code	Register address		Word count	
X	X	0000 hex		000F hex		FF hex	10 hex	8000F hex		0004 hex	

Byte-12	Byte-13	Byte-14	Byte-15	Byte-16	Byte-17	...	Byte-20
Byte count	Lock operation		Area to lock/unlock		Password		
08 hex	2 bytes		2 bytes		4 bytes		

Parameter	Description
Lock operation	Specify locking or unlocking. 0000 hex: Unlock 0001 hex: Lock <ul style="list-style-type: none"> If you specify locking the UII (EPC), TID, or user area, you will no longer be able to write data to that area. If you specify locking the access password, you will no longer be able to read the access password area. When you unlock an area, specify all of the areas that have been locked.
Area to lock/unlock	Specify one or more of the UII (EPC), TID, and user areas. UII (EPC) area: 0001 hex TID area: 0002 hex User area: 0004 hex Access password: 0008 hex <ul style="list-style-type: none"> If all zeros is specified, a command parameter error will occur.
Password	Specify the access password to set in the Tag in 8-digit hexadecimal (32 bits) (00000000 hex). Locking: The access password to set in the RF Tag to lock. Unlocking: The access password in the RF Tag to unlock.

- Note 1. When an area is locked, the specified password is written to the access password area in the RF Tag.
2. If an address error, lock error, or RF Tag system error occurs when locking an area, the access password area in the RF Tag will be cleared to all zeros.
3. When an RF Tag is unlocked, the access password area in the RF Tag will be cleared to all zeros.

● Response Formats

- Normal Response

Byte-0	Byte-1	Byte-2	Byte-3	Byte-4	Byte-5	Byte-6	Byte-7	Byte-8	Byte-9	Byte-10	Byte-11
Transaction identifier		Protocol identifier		Field length		Unit identifier	Function code	Register address		Word count	
X	X	0000 hex		0006 hex		FF hex	10 hex	2 bytes		2 bytes	

Parameter	Description
Register address	The register address from the command is set
Word count	The word count from the command is set.

Note If the reception level is required, use *GET RF TAG ADDITIONAL INFORMATION* on page 7-131.

- Error Response

Byte-0	Byte-1	Byte-2	Byte-3	Byte-4	Byte-5	Byte-6	Byte-7	Byte-8
Transaction identifier		Protocol identifier		Field length		Unit identifier	Function code	Exception code
X	X	0000 hex		0003 hex		FF hex	90 hex	1 byte

Parameter	Description
Exception code	For details, refer to <i>Exception Code</i> on page 7-7 under <i>Response Format for Error Completion</i> on page 7-7.

- Execution Examples

Example 1: Locking the User Area of the RF Tag with a Password of 12345678 Hex

TX: 000000000000FFF1080000004080001000412345678

RX: 000000000006FF1080000004

Example 2: Unlocking the User Area

TX: 000000000000FFF1080000004080000000412345678

RX: 000000000006FF1080000004

DATA FILL

● Function

This command writes the specified data to the specified number of words beginning from the specified write start address. The specifications are made in the command.

● Command Format

Byte-0	Byte-1	Byte-2	Byte-3	Byte-4	Byte-5	Byte-6	Byte-7	Byte-8	Byte-9	Byte-10	Byte-11
Transaction identifier		Protocol identifier		Field length		Unit identifier	Function code	Register address		Word count	
X	X	0000 hex		000D hex		FF hex	10 hex	8100 hex		0003 hex	

Byte-12	Byte-13	Byte-14	Byte-15	Byte-16	Byte-17	Byte-18
Byte count	Fill information					
	Fill address		Number of fill words		Fill data	
06 hex	2 bytes		2 bytes		2 bytes	

Parameter	Description	
Register address	The register address (8100 hex) that specifies filling data	
Word count	Number of words of fill information (0003 hex)	
Byte count	Number of bytes of fill information (06 hex)	
Fill information	Fill address	Specify in 4-digit hexadecimal the start address for writing data in the RF Tag. 0000 to 07FF hex: Reserved area 1000 to 17FF hex: UII (EPC) area 2000 to 27FF hex: TID area 3000 to 3FFF hex: User area
	Number of fill words	Specify in 4-digit hexadecimal the number of words of data to fill. Setting range: 0000 hex or 0001 to 0800 hex <ul style="list-style-type: none"> If 0000 hex is specified for the number of fill words, the entire memory area will be filled. You cannot write data to more than one area with the same command.
	Fill data	Specify in 4-digit hexadecimal the data to write to the RF Tag.

● Response Formats

- Normal Response

Byte-0	Byte-1	Byte-2	Byte-3	Byte-4	Byte-5	Byte-6	Byte-7	Byte-8	Byte-9	Byte-10	Byte-11
Transaction identifier		Protocol identifier		Field length		Unit identifier	Function code	Register address		Word count	
X	X	0000 hex		0006 hex		FF hex	10 hex	2 bytes		0003 hex	

Parameter	Description
Register address	The register address from the command is set
Word count	The word count from the command is set.

Note If the reception level is required, use *GET RF TAG ADDITIONAL INFORMATION* on page 7-131.

- Error Response

Byte-0	Byte-1	Byte-2	Byte-3	Byte-4	Byte-5	Byte-6	Byte-7	Byte-8
Transaction identifier		Protocol identifier		Field length		Unit identifier	Function code	Exception code
X	X	0000 hex		0003 hex		FF hex	90 hex	1 byte

Parameter	Description
Exception code	For details, refer to <i>Exception Code</i> on page 7-7 under <i>Response Format for Error Completion</i> on page 7-7.

- Execution Examples

Example 1: Writing 5A5A Hex to Four Words Starting from Word Address 0100 Hex (User Area) in the RF Tag

TX: 00000000000DFF108100000306310000045A5A

RX: 000000000006FF1081000003

Example 2: Writing 5A5A Hex to the Entire User Area in the RF Tag

TX: 00000000000DFF108100000306300000005A5A

RX: 000000000006FF1081000003

7-6-2 Multiaccess Communications Commands

SET MULTIACCESS ID READ

● Function

This command specifies reading the IDs (i.e., the UIIs (EPC codes)) of the RF Tags in the communications range.

● Command Format

Byte-0	Byte-1	Byte-2	Byte-3	Byte-4	Byte-5	Byte-6	Byte-7	Byte-8	Byte-9	Byte-10	Byte-11
Transaction identifier		Protocol identifier		Field length		Unit identifier	Function code	Register address		Word count	
X	X	0000 hex		0009 hex		FF hex	10 hex	9000F hex		0001 hex	

Byte-12	Byte-13	Byte-14
Byte count	Options	
02 hex	2 bytes	

Parameter	Description
Register address	The register address (9000 hex) that specifies setting multiaccess ID reading
Word count	The number of words for the option (0001 hex)
Byte count	The number of option bytes (02 hex)
Options	For details, refer to <i>7-3 RF Communications Command Options</i> on page 7-10. Options are implemented in a normal response to the <i>GET MULTIACCESS ID READ RESULTS</i> on page 7-36.

● Response Formats

• Normal Response

Byte-0	Byte-1	Byte-2	Byte-3	Byte-4	Byte-5	Byte-6	Byte-7	Byte-8	Byte-9
Transaction identifier		Protocol identifier		Field length		Unit identifier	Function code	Word count	
X	X	0000 hex		0004 hex		FF hex	10 hex	0001 hex	

Parameter	Description
Word count	Always 0001 hex.

• Error Response

Byte-0	Byte-1	Byte-2	Byte-3	Byte-4	Byte-5	Byte-6	Byte-7	Byte-8
Transaction identifier		Protocol identifier		Field length		Unit identifier	Function code	Exception code
X	X	0000 hex		0003 hex		FF hex	90 hex	1 byte

Parameter	Description
Exception code	For details, refer to <i>Exception Code</i> on page 7-7 under <i>Response Format for Error Completion</i> on page 7-7.

● Execution Examples

Specifying Multiaccess Reading of the IDs by the Reader/Writer with No Options

Example 1: Execution when an RF Tag Is in the Communications Range

TX: 000000000009FF1090000001020000

RX: 000000000004FF100001

Example 2: Execution When an RF Tag Is Not in the Communications Range (Exception Code: 04 Hex (Failure in Device))

TX: 000000000009FF1090000001020000

RX: 000000000003FF9004

GET MULTIACCESS ID READ RESULTS

● Function

This command reads data from the RF Tag in the communications range.

You can specify reading up to 2,048 words with one GET MULTIACCESS ID READ RESULTS command.

● Command Format

Byte-0	Byte-1	Byte-2	Byte-3	Byte-4	Byte-5	Byte-6	Byte-7	Byte-8	Byte-9	Byte-10	Byte-11
Transaction identifier		Protocol identifier		Field length		Unit identifier	Function code	Register address		Word count	
X	X	0000 hex		0006 hex		FF hex	03 hex	9100F hex		2 bytes	

Parameter	Description
Register address	The register address (9100 hex) that specifies getting the results of multiaccess ID reading
Word count	0022 hex + Option size <ul style="list-style-type: none"> For details on option sizes, refer to <i>7-3 RF Communications Command Options</i> on page 7-10.

● Response Formats

- Normal Response

Byte-0	Byte-1	Byte-2	Byte-3	Byte-4	Byte-5	Byte-6	Byte-7	Byte-8	Byte-9	Byte-10
Transaction identifier		Protocol identifier		Field length		Unit identifier	Function code	Byte count	Number of RF Tags	
X	X	0000 hex		2 bytes		FF hex	03 hex	1 byte	2 bytes	

Byte-11	Byte-12	Byte-13	Byte-14	Byte-15	...	Byte-76	Byte-77	Byte-78	Byte-79	Byte-80
Error code		StoredPC		EPC code			Options			
							Reception level		Reader/Writer Number	
2 bytes		2 bytes		62 bytes			2 bytes		2 bytes	

Parameter	Description
Field length	Gives the total number of bytes starting from the unit identifier in 4-digit hexadecimal. 0047 hex + Option size <ul style="list-style-type: none"> For details on option sizes, refer to <i>7-3 RF Communications Command Options</i> on page 7-10.
Byte count	Gives the total number of bytes starting from the number of RF Tags in 2-digit hexadecimal. 44 hex + Option size <ul style="list-style-type: none"> For details on option sizes, refer to <i>7-3 RF Communications Command Options</i> on page 7-10.
Number of RF Tags	Gives the number of RF Tags that were read in 4-digit decimal. (0001 to 001F hex) The number of RF Tags is decremented when a command response is returned.

Parameter	Description
Error code	Gives the RF Tag access results in 4-digit hexadecimal. 0000 hex: Normal end Not 0000 hex: Error code • For details on the error codes, refer to 9-2-1 <i>Command Errors</i> on page 9-4.
StoredPC	Gives the StoredPC data in 4-digit hexadecimal. The upper 5 bits are the UII (EPC) word length.
UII (EPC code)	Gives the Tag-specific information according to Gen2 standards. All bytes of the UII (EPC code) section that exceed the UII (EPC) word length in the StoredPC are filled with 00 hex.
Options	This section may be omitted depending on the option value for the SET MULTIACCESS ID READ command.
Reception level	The reception level is attached in signed 4-digit hexadecimal. FFFF to FF9D hex (-1 to -99 [dBm])
Reader/Writer Number	This displays the Reader/Writer number of the reader/writer communicating with the RF Tag in 4 hexadecimal digits. 0000 hex to 0007 hex

- Error Response

Byte-0	Byte-1	Byte-2	Byte-3	Byte-4	Byte-5	Byte-6	Byte-7	Byte-8
Transaction identifier		Protocol identifier		Field length		Unit identifier	Function code	Exception code
X	X	0000 hex		0003 hex		FF hex	83 hex	1 byte

Parameter	Description
Exception code	For details, refer to <i>Exception Code</i> on page 7-7 under <i>Response Format for Error Completion</i> on page 7-7.

● Execution Examples

Specifying Getting the Results of Multiaccess Reading of the IDs by the Reader/Writer with No Options

There are three RF Tags in the communications range.

① Getting the First Results (Getting the Communications Results for RF Tag A)

TX: 000000000006FF0391000022

RX: 00000000047FF0344000300003000AAAA...AAAA0000...0000

*Number of RF Tags: 3, RF Tag A error code + StoredPC + UII (EPC code) (The six words of the UII (EPC) length are all AAAA hex.)

② Getting the Second Results (Getting the Communications Results for RF Tag B)

TX: 000000000006FF0391000022

RX: 00000000047FF0344000200003000BBBB...BBBB0000...0000

*Number of RF Tags: 2, RF Tag A error code + StoredPC + UII (EPC code) (The six words of the UII (EPC) length are all BBBB hex.)

③ Getting the Third Results (Getting the Communications Results for RF Tag C)

TX: 000000000006FF0391000022

RX: 000000000047FF0344000120020000...0000

*Number of RF Tags: 1, RF Tag C error code (2002 hex: RF Tag communications failure)

④ Getting the Fourth Results (No Communications Results)

TX: 000000000006FF0391000022

RX: 000000000047FF034400000000...0000

*Number of RF Tags: 0, Remaining data: All 00 hex

SET MULTIACCESS DATA READ

● Function

This command specifies reading data from the RF Tags in the communications range.

● Command Format

Byte-0	Byte-1	Byte-2	Byte-3	Byte-4	Byte-5	Byte-6	Byte-7	Byte-8	Byte-9	Byte-10	Byte-11
Transaction identifier		Protocol identifier		Field length		Unit identifier	Function code	Register address		Word count	
X	X	0000 hex		000D hex		FF hex	10 hex	9200F hex		0003 hex	

Byte-12	Byte-13	Byte-14	Byte-15	Byte-16	Byte-17	Byte-18
Byte count	Read area start address		Read size		Options	
06 hex	2 bytes		2 bytes		2 bytes	

Parameter	Description
Register address	The register address (9200 hex) that specifies setting multiaccess data reading
Read area start address	Specify in 4-digit hexadecimal the start address for reading data. Setting ranges (word address specifications) 0000 to 07FF hex: Reserved area 1000 to 17FF hex: EPC area 2000 to 27FF hex: TID area 3000 to 3FFF hex: User area
Read size	Specify in 4-digit hexadecimal the number of words of data to read. Setting range: 0001 to 0020 hex (1 to 32)
Options	For details, refer to 7-3 <i>RF Communications Command Options</i> on page 7-10.

● Response Formats

• Normal Response

Byte-0	Byte-1	Byte-2	Byte-3	Byte-4	Byte-5	Byte-6	Byte-7	Byte-8	Byte-9
Transaction identifier		Protocol identifier		Field length		Unit identifier	Function code	Word count	
X	X	0000 hex		0004 hex		FF hex	10 hex	0003 hex	

Parameter	Description
Word count	Always 0003 hex.

• Error Response

Byte-0	Byte-1	Byte-2	Byte-3	Byte-4	Byte-5	Byte-6	Byte-7	Byte-8
Transaction identifier		Protocol identifier		Field length		Unit identifier	Function code	Exception code
X	X	0000 hex		0003 hex		FF hex	90 hex	1 byte

Parameter	Description
Exception code	For details, refer to <i>Exception Code</i> on page 7-7 under <i>Response Format for Error Completion</i> on page 7-7.

● **Execution Examples**

Specifying to the Reader/Writer a Multiaccess Data Read of Four Words Starting from Word Address 0123 Hex (User Area) with No Options

Example 1: Execution when an RF Tag Is in the Communications Range

TX: 0000000000DFF109200000306312300040000

RX: 000000000004FF100003

Example 2: Execution When an RF Tag Is Not in the Communications Range (Exception Code: 04 Hex (Failure in Device))

TX: 0000000000DFF109200000306312300040000

RX: 000000000003FF9004

GET MULTIACCESS DATA READ RESULTS

● Function

This command specifies getting the results of reading data from the RF Tags in the communications range.

To enable identifying the RF Tags that were read, the StoredPC and EPC code are attached to the read data.

The number of results data from RF Tag communications stored in the Reader/Writer is decremented when a command response is returned.

● Command Format

Byte-0	Byte-1	Byte-2	Byte-3	Byte-4	Byte-5	Byte-6	Byte-7	Byte-8	Byte-9	Byte-10	Byte-11
Transaction identifier		Protocol identifier		Field length		Unit identifier	Function code	Register address		Word count	
X	X	0000 hex		0006 hex		FF hex	03 hex	9300 hex		2 bytes	

Parameter	Description
Register address	The register address (9300 hex) that specifies getting the results of multiaccess data reading
Word count	Specify the total number of words starting from the number of RF Tags in the response in 4-digit hexadecimal. 0003 to 0022 hex + Option size <ul style="list-style-type: none"> For details on option sizes, refer to 7-3 <i>RF Communications Command Options</i> on page 7-10.

● Response Formats

- Normal Response

Byte-0	Byte-1	Byte-2	Byte-3	Byte-4	Byte-5	Byte-6	Byte-7	Byte-8	Byte-10	Byte-11
Transaction identifier		Protocol identifier		Field length		Unit identifier	Function code	Byte count	Number of RF Tags	
X	X	0000 hex		2 bytes		FF hex	03 hex	1 byte	2 bytes	

Byte-12	Byte-12+ n-1
Error code		Read data				Options				
2 bytes		2 to 64 bytes				0 to 68 bytes				
		StoredPC		EPC code		Reception level		Reader/Writer Number		
		2 bytes		62 bytes		2 bytes		2 bytes		

n: 6 to 132

Parameter	Description
Field length	Gives the total number of bytes starting from the unit identifier in 4-digit hexadecimal. 0009 to 0047 hex + Option size <ul style="list-style-type: none"> For details on option sizes, refer to 7-3 <i>RF Communications Command Options</i> on page 7-10.

Parameter	Description
Byte count	Gives the total number of bytes starting from the number of RF Tags in 2-digit hexadecimal. 06 to 44 hex + Option size • For details on option sizes, refer to <i>7-3 RF Communications Command Options</i> on page 7-10.
Number of RF Tags	Gives the number of RF Tags that were read in 4-digit decimal. (0001 to 001F hex) The number of RF Tags is decremented when a command response is returned.
Error code	Gives the RF Tag access results in 4-digit hexadecimal. 0000 hex: Normal end Not 0000 hex: Error code • For details on the error codes, refer to <i>9-2-1 Command Errors</i> on page 9-4.
Read data	The data that was read from the RF Tag is attached.
Options	This section may be omitted depending on the option value for the SET MULTIACCESS ID READ command.
StoredPC	Gives the StoredPC data in 4-digit hexadecimal. The upper 5 bits are the UII (EPC) word length.
UII (EPC code)	Gives the Tag-specific information according to Gen2 standards. All bytes of the UII (EPC code) section that exceed the UII (EPC) word length in the StoredPC are filled with 00 hex.
Reception level	The reception level is attached in signed 4-digit hexadecimal. FFFF to FF9D hex (-1 to -99 [dBm])
Reader/Writer Number	This displays the Reader/Writer number of the reader/writer communicating with the RF Tag in 4 hexadecimal digits. 0000 hex to 0007 hex

- Error Response

Byte-0	Byte-1	Byte-2	Byte-3	Byte-4	Byte-5	Byte-6	Byte-7	Byte-8
Transaction identifier		Protocol identifier		Field length		Unit identifier	Function code	Exception code
X	X	0000 hex		0003 hex		FF hex	83 hex	1 byte

Parameter	Description
Exception code	For details, refer to <i>Exception Code</i> on page 7-7 under <i>Response Format for Error Completion</i> on page 7-7.

● Execution Examples

Specifying Getting the Results of Multiaccess Reading of Four-word Data by the Reader/Writer with No Options

There are three RF Tags in the communications range.

① Getting the First Results (Getting the Communications Results for RF Tag A)

TX: 000000000006FF0393000006

RX: 0000000000FFF030C00030000AAAA...AAAA

*Number of RF Tags: 3, RF Tag A error code + Read data (All four words are AAAA hex.)

② Getting the Second Results (Getting the Communications Results for RF Tag B)

TX: 000000000006FF0393000006

RX: 0000000000FFF030C00020000AAAA...AAAA

*Number of RF Tags: 2, RF Tag B error code + Read data (All four words are BBBB hex.)

③ Getting the Third Results (Getting the Communications Results for RF Tag C)

TX: 000000000006FF0393000006

RX: 0000000000FFF030C000120020000...0000

*Number of RF Tags: 1, RF Tag C error code (2002 hex: RF Tag communications failure)

④ Getting the Fourth Results (No Communications Results)

TX: 000000000006FF0393000006

RX: 0000000000FFF030C000000000000...0000

*Number of RF Tags: 0, Remaining data: All 00 hex

7-6-3 Modbus Expansion Communications Commands

EXTENDED DATA READ

● Function

This command reads data from the RF Tag in the communications range.

You can specify reading up to 2,048 words with one EXTENDED DATA READ command.

● Command Format

Byte-0	Byte-1	Byte-2	Byte-3	Byte-4	Byte-5	Byte-6	Byte-7	Byte-8	Byte-9	Byte-10	Byte-11
Transaction identifier		Protocol identifier		Field length		Unit identifier	Function code	Subfunction code		Read area start address	
X	X	0000 hex		000A hex		FF hex	64 hex	0001 hex		2 bytes	

Byte-12	Byte-13	Byte-14	Byte-15
Read size		Options	
2 bytes		2 bytes	

Parameter	Description
Subfunction code	0001 hex: EXTENDED DATA READ
Read area start address	Specify in 4-digit hexadecimal the start address for reading data. Setting ranges (word address specifications) 0000 to 07FF hex: Reserved area 1000 to 17FF hex: UII (EPC) area 2000 to 27FF hex: TID area 3000 to 3FFF hex: User area
Read size	Specify in 4-digit hexadecimal the start address for reading data. Setting range: 0001 to 0800 hex (2,048 words max.)
Options	For details, refer to 7-3 <i>RF Communications Command Options</i> on page 7-10.

● Response Formats

• Normal Response

Byte-0	Byte-1	Byte-2	Byte-3	Byte-4	Byte-5	Byte-6	Byte-7	Byte-8	Byte-9	Byte-10	Byte-11
Transaction identifier		Protocol identifier		Field length		Unit identifier	Function code	Subfunction code		Error code	
X	X	0000 hex		2 bytes		FF hex	64 hex	0001 hex		0000 hex	

Byte-12	Byte-n
Read data			Options									
1 to 2,048 words (2 to 4,096 bytes)			0 to 70 bytes									
			StoredPC		UII (EPC code)		Reception level		Diagnostic results		Reader/Writer Number	
			2 bytes		62 bytes		2 bytes		2 bytes		2 bytes	
Note The contents depend on the options specified in the command.												

Parameter	Description
Field length	0008 to 1006 hex + Option size <ul style="list-style-type: none"> For details on option sizes, refer to <i>7-3 RF Communications Command Options</i> on page 7-10.
Read data	The data that was read from the RF Tag is attached. (Range: 0001 to 0800 hex, in words)
Options	These parameters may be omitted depending on the option value.
StoredPC	Gives the StoredPC data in 4-digit hexadecimal. The upper 5 bits are the UII (EPC) word length.
UII (EPC code)	Gives the Tag-specific information according to Gen2 standards. All bytes of the UII (EPC code) section that exceed the UII (EPC) word length in the StoredPC are filled with 00 hex.
Reception level	The reception level is attached in signed 4-digit hexadecimal. FFFF to FF9D hex (-1 to -99 [dBm])
Diagnostic results	Gives the diagnostic results in 4-digit hexadecimal. For details, refer to <i>Response Formats</i> on page 7-136 under <i>GET COMMUNICATIONS DIAGNOSTIC INFORMATION</i> on page 7-136.
Reader/Writer Number	This displays the Reader/Writer number of the reader/writer communicating with the RF Tag in 4 hexadecimal digits. 0000 hex to 0007 hex

- Error Response: RF Tag Communications Error

Byte-0	Byte-1	Byte-2	Byte-3	Byte-4	Byte-5	Byte-6	Byte-7	Byte-8	Byte-9	Byte-10	Byte-11
Transaction identifier		Protocol identifier		Field length		Unit identifier	Function code	Subfunction code		Error code	
X	X	0000 hex		0006 hex		FF hex	64 hex	0001 hex		2 bytes	

Parameter	Description
Error code	For details, refer to <i>9-2-1 Command Errors</i> on page 9-4.

- Error Response: Command Error

Byte-0	Byte-1	Byte-2	Byte-3	Byte-4	Byte-5	Byte-6	Byte-7	Byte-8
Transaction identifier		Protocol identifier		Field length		Unit identifier	Function code	Exception code
X	X	0000 hex		0003 hex		FF hex	E5 hex	1 byte

Parameter	Description
Exception code	For details, refer to <i>Exception Code</i> on page 7-7 under <i>Response Format for Error Completion</i> on page 7-7.

● Execution Examples

Reading 2,048 Words of Data Starting from Word Address 0000 Hex (User Area) in the RF Tag with No Options

Example 1: Execution When an RF Tag Is Not in the Communications Range (Read Data: 1111222233334444...FFFF Hex)

TX: 0000000000AFF640001300008000000

RX: 000000000806FF64000100001111222233334444...FFFF

Example 2: Execution When an RF Tag Is Not in the Communications Range (Error Code: 2001 Hex (RF Tag Missing Error))

TX: 0000000000AFF640001300008000000

RX: 000000000006FF6400012001

EXTENDED DATA WRITE

● Function

This command writes data to the RF Tag in the communications range.

You can specify writing up to 2,048 words with one EXTENDED DATA WRITE command.

● Command Format

Byte-0	Byte-1	Byte-2	Byte-3	Byte-4	Byte-5	Byte-6	Byte-7	Byte-8	Byte-9	Byte-10	Byte-11
Transaction identifier		Protocol identifier		Field length		Unit identifier	Function code	Subfunction code		Write area start address	
X	X	0000 hex		000C to 100A hex		FF hex	64 hex	0002 hex		2 bytes	

Byte-12	Byte-13	Byte-14	...	Byte-n + n
Write size		Data to write		Options
2 bytes		1 to 2,048 words (2 to 4,096 bytes)		2 bytes

Parameter	Description
Field length	Setting range: 000C to 100A hex
Subfunction code	0002 hex: EXTENDED DATA WRITE
Write area start address	Specify in 4-digit hexadecimal the start address for writing data in the RF Tag. Setting ranges (word address specifications) 0000 to 07FF hex: Reserved area 1000 to 17FF hex: UII (EPC) area 2000 to 27FF hex: TID area 3000 to 3FFF hex: User area
Write size	Specify in 4-digit hexadecimal the number of words of data to write. Setting range: 0001 to 0800 hex (2,048 words max.)
Data to write	The data to write
Options	For details, refer to 7-3 <i>RF Communications Command Options</i> on page 7-10.

● Response Formats

- Normal Response

Byte-0	Byte-1	Byte-2	Byte-3	Byte-4	Byte-5	Byte-6	Byte-7	Byte-8	Byte-9	Byte-10	Byte-11
Transaction identifier		Protocol identifier		Field length		Unit identifier	Function code	Subfunction code		Error code	
X	X	0000 hex		2 bytes		FF hex	64 hex	0002 hex		0000 hex	

Byte-12	Byte-n
Options										
0 to 70 bytes										
StoredPC		UII (EPC code)		Reception level		Diagnostic results		Reader/Writer Number		
2 bytes		62 bytes		2 bytes		2 bytes		2 bytes		

Parameter	Description
Field length	Normal completion: 0006 hex + Option size <ul style="list-style-type: none"> For details on option sizes, refer to 7-3 <i>RF Communications Command Options</i> on page 7-10.
Error code	For details, refer to 9-2-1 <i>Command Errors</i> on page 9-4.
Options	These parameters may be omitted depending on the option value.
StoredPC	Gives the StoredPC data in 4-digit hexadecimal. The upper 5 bits are the UII (EPC) word length.
UII (EPC code)	Gives the Tag-specific information according to Gen2 standards. All bytes of the UII (EPC code) section that exceed the UII (EPC) word length in the StoredPC are filled with 00 hex.
Reception level	The reception level is attached in signed 4-digit hexadecimal. FFFF to FF9D hex (-1 to -99 [dBm])
Diagnostic results	Gives the diagnostic results in 4-digit hexadecimal. For details, refer to <i>Response Formats</i> on page 7-136 under <i>GET COMMUNICATIONS DIAGNOSTIC INFORMATION</i> on page 7-136.
Reader/Writer Number	This displays the Reader/Writer number of the reader/writer communicating with the RF Tag in 4 hexadecimal digits. 0000 hex to 0007 hex

- Error Response: RF Tag Communications Error

Byte-0	Byte-1	Byte-2	Byte-3	Byte-4	Byte-5	Byte-6	Byte-7	Byte-8	Byte-9	Byte-10	Byte-11
Transaction identifier		Protocol identifier		Field length		Unit identifier	Function code	Subfunction code		Error code	
X	X	0000 hex		0006 hex		FF hex	64 hex	0002 hex		2 bytes	

Parameter	Description
Error code	For details, refer to 9-2-1 <i>Command Errors</i> on page 9-4.

- Error Response: Command Error

Byte-0	Byte-1	Byte-2	Byte-3	Byte-4	Byte-5	Byte-6	Byte-7	Byte-8
Transaction identifier		Protocol identifier		Field length		Unit identifier	Function code	Exception code
X	X	0000 hex		0003 hex		FF hex	E4 hex	1 byte

Parameter	Description
Exception code	For details, refer to <i>Exception Code</i> on page 7-7 under <i>Response Format for Error Completion</i> on page 7-7.

● Execution Examples

Writing 2,048 Words of Data Starting from Word Address 0000 Hex (User Area) in the RF Tag with No Options

Example 1: Execution When an RF Tag Is Not in the Communications Range (Error Code: 0000 (Normal Completion))

TX: 00000000100AFF64000230001111222233334444...FFFF0000

RX: 000000000006FF6600010000

Example 2: Execution When an RF Tag Is Not in the Communications Range (Error Code: 2001 Hex (RF Tag Missing Error))

TX: 00000000100AFF64000230001111222233334444...FFFF0000

RX: 000000000006FF640002200

EXTENDED MULTIACCESS ID READ

● Function

This command reads the IDs (UIIs (EPC codes)) of multiple RF Tags in the communications range. You can get the IDs (UIIs (EPC codes)) of more than one RF Tag with one EXTENDED MULTIACCESS ID READ command.

● Command Format

Byte-0	Byte-1	Byte-2	Byte-3	Byte-4	Byte-5	Byte-6	Byte-7	Byte-8	Byte-9	Byte-10	Byte-11
Transaction identifier		Protocol identifier		Field length		Unit identifier	Function code	Subfunction code		Options	
X	X	0000 hex		0006 hex		FF hex	64 hex	0003 hex		2 bytes	

Parameter	Description
Subfunction code	0003 hex: EXTENDED MULTIACCESS ID READ
Options	For details, refer to 7-3 RF Communications Command Options on page 7-10.

● Response Formats

- Normal Response or Error Response: RF Tag Communications Error

Byte-0	Byte-1	Byte-2	Byte-3	Byte-4	Byte-5	Byte-6	Byte-7	Byte-8	Byte-9	Byte-10	Byte-11
Transaction identifier		Protocol identifier		Field length		Unit identifier	Function code	Subfunction code		Number of RF Tags (m)	
X	X	0000 hex		2 bytes		FF hex	64 hex	0003 hex		0000 to 0040 hex	

Byte-12	...	Byte-12 + n - 1	...	Byte-12+n *(m-1)	...	Byte-12+(n*m)-1
Information from RF Tag 1		...	Information from RF Tag m			
n = 66 to 70 bytes		...	n = 66 to 70 bytes			

Information from RF Tag x				
Error code	StoredPC	UII (EPC code)	Options	
			Reception level	Reader/Writer Number
2 bytes	2 bytes	62 bytes	2 bytes	2 bytes

Parameter	Description
Field length	0048 to 0F86 hex + (Option size × m) <ul style="list-style-type: none"> • For details on option sizes, refer to 7-3 RF Communications Command Options on page 7-10.
Number of RF Tags	Gives the number of RF Tags that were detected in 4-digit decimal. 0000 to 0040 hex (0 to 64)

Parameter		Description
Information from RF Tag 1	Error code	For details, refer to 9-2-1 <i>Command Errors</i> on page 9-4.
	StoredPC	Gives the StoredPC data in 4-digit hexadecimal. The upper 5 bits are the UII (EPC) word length.
	UII (EPC code)	Gives the Tag-specific information according to Gen2 standards. All bytes of the UII (EPC code) section that exceed the UII (EPC) word length in the StoredPC are filled with 00 hex.
	Options	These parameters may be omitted depending on the option value.
	Reception level	The reception level is attached in signed 4-digit hexadecimal. FFFF to FF9D hex (-1 to -99 [dBm])
	Reader/Writer Number	This displays the Reader/Writer number of the reader/writer communicating with the RF Tag in 4 hexadecimal digits. 0000 hex to 0007 hex

- Error Response: Command Error

Byte-0	Byte-1	Byte-2	Byte-3	Byte-4	Byte-5	Byte-6	Byte-7	Byte-8
Transaction identifier		Protocol identifier		Field length		Unit identifier	Function code	Exception code
X	X	0000 hex		0003 hex		FF hex	E4 hex	1 byte

Parameter	Description
Exception code	For details, refer to <i>Exception Code</i> on page 7-7 under 7-2-3 <i>Response Format for Error Completion</i> on page 7-7.

● Execution Examples

Execution for Reading ID Data from Multiple RF Tags with no Option Specification

Example 1: Execution When Four RF Tags Are in the Communications Range

TX: 000000000006FF6400030000

RX: 000000000116FF6400030004

00003000AAAA...AAAA0000...0000: RF Tag A error code + StoredPC + UII (EPC code) (The six words of the UII (EPC) length are all AAAA hex.)

00003000BBBB...BBBB0000...0000: RF Tag B error code + StoredPC + UII (EPC code) (The six words of the UII (EPC) length are all BBBB hex.)

00003000CCCC...CCCC0000...0000: RF Tag C error code + StoredPC + UII (EPC code) (The six words of the UII (EPC) length are all CCCC hex.)

20020000000000000000...0000: RF Tag D error code (2002 hex (RF Tag communications failure))

Example 2: Execution When an RF Tag Is Not in the Communications Range (Exception Code: 04 Hex (Failure in Device))

TX: 000000000006FF6400030000

RX: 000000000003FFE404

EXTENDED MULTIACCESS DATA READ

● Function

This command reads data from multiple RF Tags in the communications range.

You can get data from more than one RF Tag with one EXTENDED MULTIACCESS DATA READ command.

● Command Format

Byte-0	Byte-1	Byte-2	Byte-3	Byte-4	Byte-5	Byte-6	Byte-7	Byte-8	Byte-9	Byte-10	Byte-11
Transaction identifier		Protocol identifier		Field length		Unit identifier	Function code	Subfunction code		Read area start address	
X	X	0000 hex		000A hex		FF hex	64 hex	0004 hex		2 bytes	

Byte-12	Byte-13	Byte-14	Byte-15
Read size		Options	
2 bytes		2 bytes	

Parameter	Description
Subfunction code	0004 hex: EXTENDED MULTIACCESS DATA READ
Read area start address	Specify in 4-digit hexadecimal the start address for reading data. Setting ranges (word address specifications) 0000 to 07FF hex: Reserved area 1000 to 17FF hex: UII (EPC) area 2000 to 27FF hex: TID area 3000 to 3FFF hex: User area
Read size	Specify in 4-digit hexadecimal the start address for reading data. Setting range: 0001 to 0020 hex (1 to 32)
Options	For details, refer to <i>7-3 RF Communications Command Options</i> on page 7-10.

● Response Formats

- Normal Response or Error Response: RF Tag Communication Error

Byte-0	Byte-1	Byte-2	Byte-3	Byte-4	Byte-5	Byte-6	Byte-7	Byte-8	Byte-9	Byte-10	Byte-11
Transaction identifier		Protocol identifier		Field length		Unit identifier	Function code	Subfunction code		Number of RF Tags (m)	
X	X	0000 hex		2 bytes		FF hex	64 hex	0004 hex		0000 to 0040 hex	

Byte-12	...	Byte-12 + n - 1	...	Byte-12+n* (m-1)	...	Byte-12+ (n*m)-1
Information from RF Tag 1			...	Information from RF Tag m		
n = 4 to 134 bytes			...	n = 4 to 134 bytes		

Information from RF Tag x			
Error code	Read data		Options
2 bytes	2 to 64 bytes		0 to 66 bytes
	StoredPC	UII (EPC code)	Reception level
	2 bytes	62 bytes	2 bytes
			Reader/Writer Number
			2 bytes

Parameter		Description
Field length		000A to 2106 hex + (Option size × m) • For details on option sizes, refer to 7-3 <i>RF Communications Command Options</i> on page 7-10.
Number of RF Tags		Gives the number of RF Tags that were detected in 4-digit decimal. 0000 to 0040 hex (0 to 64)
Information from RF Tag 1	Error code	For details, refer to 9-2-1 <i>Command Errors</i> on page 9-4.
	Read data	The data that was read from the RF Tag is attached. The bytes that exceed the word count will be filled with 00 hex.
	Options	This section may be omitted depending on the option value for the SET MULTIACCESS ID READ command.
	StoredPC	Gives the StoredPC data in 4-digit hexadecimal. The upper 5 bits are the UII (EPC) word length.
	UII (EPC code)	Gives the Tag-specific information according to Gen2 standards. All bytes of the UII (EPC code) section that exceed the UII (EPC) word length in the StoredPC are filled with 00 hex.
	Reception level	The reception level is attached in signed 4-digit hexadecimal. FFFF to FF9D hex (-1 to -99 [dBm])
	Reader/Writer Number	This displays the Reader/Writer number of the reader/writer communicating with the RF Tag in 4 hexadecimal digits. 0000 hex to 0007 hex

- Error Response: Command Error

Byte-0	Byte-1	Byte-2	Byte-3	Byte-4	Byte-5	Byte-6	Byte-7	Byte-8
Transaction identifier		Protocol identifier		Field length		Unit identifier	Function code	Exception code
X	X	0000 hex		0003 hex		FF hex	E4 hex	1 byte

Parameter	Description
Exception code	For details, refer to <i>Exception Code</i> on page 7-7 under 7-2-3 <i>Response Format for Error Completion</i> on page 7-7.

● Execution Examples

Reading 4 Words of Data Starting from Word Address 0123 Hex (User Area) in Multiple RF Tags with No Options

Example 1: Execution When Four RF Tags Are in the Communications Range

TX: 000000000000AFF640004312300040000

RX: 000000000002EFF6400040004

0000AAAAAAAAAAAAAAAA: RF Tag A error code + Read data (4 words, all AAAA hex)

0000BBBBBBBBBBBBBBBB: RF Tag B error code + Read data (4 words, all BBBB hex)

0000CCCCCCCCCCCCCCCC: RF Tag C error code + Read data (4 words, all CCCC hex)

20020000000000000000: RF Tag D error code (2002 hex (RF Tag communications failure))

Example 2: Execution When an RF Tag Is Not in the Communications Range (Exception Code: 04 Hex (Failure in Device))

TX: 000000000000AFF640004312300040000

RX: 000000000003FFE404

7-6-4 Reader/Writer Control Commands

INITIALIZE

● Function

This command initializes the Reader/Writer settings. (That is, it returns them to the default settings.)

● Command Format

Byte-0	Byte-1	Byte-2	Byte-3	Byte-4	Byte-5	Byte-6	Byte-7	Byte-8	Byte-9	Byte-10	Byte-11
Transaction identifier		Protocol identifier		Field length		Unit identifier	Function code	Register address		Word count	
X	X	0000 hex		0009 hex		FF hex	10 hex	A000 hex		0001 hex	

Byte-12	Byte-13	Byte-14
Byte count	Options	
02 hex	0000 hex	

Parameter	Description
Register address	The register address (A000 hex) that specifies initializing settings
Word count	The number of words for the option (0001 hex)
Byte count	The number of option bytes (02 hex)
Options	0000 hex: No options

● Response Formats

• Normal Response

Byte-0	Byte-1	Byte-2	Byte-3	Byte-4	Byte-5	Byte-6	Byte-7	Byte-8	Byte-9	Byte-10	Byte-11
Transaction identifier		Protocol identifier		Field length		Unit identifier	Function code	Register address		Word count	
X	X	0000 hex		0006 hex		FF hex	10 hex	A000 hex		0001 hex	

Parameter	Description
Register address	The register address from the command is set.
Word count	The word count from the command is set.

• Error Response

Byte-0	Byte-1	Byte-2	Byte-3	Byte-4	Byte-5	Byte-6	Byte-7	Byte-8
Transaction identifier		Protocol identifier		Field length		Unit identifier	Function code	Exception code
X	X	0000 hex		0003 hex		FF hex	90 hex	1 byte

Parameter	Description
Exception code	For details, refer to <i>Exception Code</i> on page 7-7 under <i>7-2-3 Response Format for Error Completion</i> on page 7-7.

- **Execution Examples**

Execution to Initialize the Reader/Writer Settings

TX: 000000000009FF10A0000001020000

RX: 000000000006FF10A0000001

RESET

● Function

This command restarts the entire Reader/Writer.

● Command Format

Byte-0	Byte-1	Byte-2	Byte-3	Byte-4	Byte-5	Byte-6	Byte-7	Byte-8	Byte-9	Byte-10	Byte-11
Transaction identifier		Protocol identifier		Field length		Unit identifier	Function code	Register address		Word count	
X	X	0000 hex		0009 hex		FF hex	10 hex	A100 hex		0001 hex	

Byte-12	Byte-13	Byte-14
Byte count	Options	
02 hex	2 bytes	

Parameter	Description
Register address	The register address (A100 hex) that specifies resetting the Reader/Writer.
Word count	The number of words for the option (0001 hex)
Byte count	The number of option bytes (02 hex)
Options	0001 hex: Normal reset FFFF hex: Forced reset

● Response Formats

• Normal Response

Byte-0	Byte-1	Byte-2	Byte-3	Byte-4	Byte-5	Byte-6	Byte-7	Byte-8	Byte-9	Byte-10	Byte-11
Transaction identifier		Protocol identifier		Field length		Unit identifier	Function code	Register address		Word count	
X	X	0000 hex		0006 hex		FF hex	10 hex	A100 hex		0001 hex	

Parameter	Description
Register address	The register address from the command is set.
Word count	The word count from the command is set.

Note A response is not returned for forced resetting.

• Error Response

Byte-0	Byte-1	Byte-2	Byte-3	Byte-4	Byte-5	Byte-6	Byte-7	Byte-8
Transaction identifier		Protocol identifier		Field length		Unit identifier	Function code	Exception code
X	X	0000 hex		0003 hex		FF hex	90 hex	1 byte

Parameter	Description
Exception code	For details, refer to <i>Exception Code</i> on page 7-7 under <i>7-2-3 Response Format for Error Completion</i> on page 7-7.

● Execution Examples

Execution to Restart the Entire Reader/Writer

TX: 000000000009FF10A1000001020000

RX: 000000000006FF10A1000001

STOP

● Function

This command stops RF Tag communications command execution by the Reader/Writer.

● Command Format

Byte-0	Byte-1	Byte-2	Byte-3	Byte-4	Byte-5	Byte-6	Byte-7	Byte-8	Byte-9	Byte-10	Byte-11
Transaction identifier		Protocol identifier		Field length		Unit identifier	Function code	Register address		Word count	
X	X	0000 hex		0009 hex		FF hex	10 hex	A200 hex		0001 hex	

Byte-12	Byte-13	Byte-14
Byte count	Options	
02 hex	0000 hex	

Parameter	Description
Register address	The register address (A200 hex) that specifies stopping execution
Word count	The number of words for the option (0001 hex)
Byte count	The number of option bytes (02 hex)
Options	0000 hex: No options

● Response Formats

• Normal Response

Byte-0	Byte-1	Byte-2	Byte-3	Byte-4	Byte-5	Byte-6	Byte-7	Byte-8	Byte-9	Byte-10	Byte-11
Transaction identifier		Protocol identifier		Field length		Unit identifier	Function code	Register address		Word count	
X	X	0000 hex		0006 hex		FF hex	10 hex	A200 hex		0001 hex	

Parameter	Description
Register address	The register address from the command is set.
Word count	The word count from the command is set.

Note A response is not returned for forced resetting.

• Error Response

Byte-0	Byte-1	Byte-2	Byte-3	Byte-4	Byte-5	Byte-6	Byte-7	Byte-8
Transaction identifier		Protocol identifier		Field length		Unit identifier	Function code	Exception code
X	X	0000 hex		0003 hex		FF hex	90 hex	1 byte

Parameter	Description
Exception code	For details, refer to <i>Exception Code</i> on page 7-7 under <i>7-2-3 Response Format for Error Completion</i> on page 7-7.

● Execution Examples

Execution to Stop RF Tag Communications Command Execution by the Reader/Writer

TX: 000000000009FF10A2000001020000

RX: 000000000006FF10A2000001

RESET FOCUS

● Function

This command initializes the target level information of all the RF Tags that are being monitored by the Reader/Writer in Focus Mode.

● Command Format

Byte-0	Byte-1	Byte-2	Byte-3	Byte-4	Byte-5	Byte-6	Byte-7	Byte-8	Byte-9	Byte-10	Byte-11
Transaction identifier		Protocol identifier		Field length		Unit identifier	Function code	Register address		Word count	
X	X	0000 hex		0009 hex		FF hex	10 hex	A300 hex		0001 hex	

Byte-12	Byte-13	Byte-14
Byte count	Options	
02 hex	0000 hex	

Parameter	Description
Register address	The register address (A300 hex) that specifies resetting the focus
Word count	The number of words for the option (0001 hex)
Byte count	The number of option bytes (02 hex)
Options	0000 hex: No options

● Response Formats

• Normal Response

Byte-0	Byte-1	Byte-2	Byte-3	Byte-4	Byte-5	Byte-6	Byte-7	Byte-8	Byte-9	Byte-10	Byte-11
Transaction identifier		Protocol identifier		Field length		Unit identifier	Function code	Register address		Word count	
X	X	0000 hex		0006 hex		FF hex	10 hex	A300 hex		0001 hex	

Parameter	Description
Register address	The register address from the command is set.
Word count	The word count from the command is set.

• Error Response

Byte-0	Byte-1	Byte-2	Byte-3	Byte-4	Byte-5	Byte-6	Byte-7	Byte-8
Transaction identifier		Protocol identifier		Field length		Unit identifier	Function code	Exception code
X	X	0000 hex		0003 hex		FF hex	90 hex	1 byte

Parameter	Description
Exception code	For details, refer to <i>Exception Code</i> on page 7-7 under <i>7-2-3 Response Format for Error Completion</i> on page 7-7.

● Execution Examples

Execution to Initialize Target Levels of All RF Tags Monitored by Reader/Writer in Focus Mode

TX: 000000000009FF10A3000001020000

RX: 000000000006FF10A3000001

7-6-5 Reader/Writer Setting Commands: Network Settings

SET TCP/IP COMMUNICATIONS CONDITIONS

● Function

This command sets the TCP/IP communications conditions of the Reader/Writer.

● Command Format

Byte-0	Byte-1	Byte-2	Byte-3	Byte-4	Byte-5	Byte-6	Byte-7	Byte-8	Byte-9	Byte-10	Byte-11
Transaction identifier		Protocol identifier		Field length		Unit identifier	Function code	Register address		Word count	
X	X	0000 hex		0015 hex		FF hex	10 hex	B000 hex		0007 hex	

Byte-12	Byte-13	Byte-14	Byte-15	...	Byte-18	Byte-19	...	Byte-22	Byte-23	...	Byte-26	
Byte count	TCP/IP communications conditions											
0E hex	IP address setting method	IP address				Subnet mask			Gateway address			
	2 bytes	4 bytes				4 bytes			4 bytes			

Parameter	Description	Default setting	
Register address	The register address (B000 hex) that specifies the TCP/IP communications conditions.		
Word count	The number of words in the TCP/IP communications conditions (0007 hex)		
Byte count	The number of bytes in the TCP/IP communications conditions (0E hex)		
TCP/IP communications conditions	IP address setting method	Specify in 4-digit hexadecimal the IP address setting method. 0000 hex: Fixed setting 00001 hex: Obtain from BOOTP server 0002 hex: Get from BOOTP server as fixed settings	0000 hex
	IP address ^{*1}	Specify in 8-digit hexadecimal the fixed IP addresses to set. Setting range: 00000000 to DFFFFFFF hex Example: C0A801C8 hex (192.168.1.200)	C0A801C8 hex
	Subnet mask ^{*1}	Specify in 8-digit hexadecimal the subnet mask to set. Setting range: FF000000 to FFFFFFFF hex Example: FFFFFFF0 hex (255.255.255.0)	FFFFFFF0 hex
	Gateway address ^{*1}	Specify in 8-digit hexadecimal the gateway address to set. Setting range: 00000000 to DFFFFFFF hex Example: C0A801FE hex (192.168.1.254)	C0A801FE hex

*1. Specify 00000000 hex for any IP address setting method other than using a fixed IP address.

● Response Formats

- Normal Response

Byte-0	Byte-1	Byte-2	Byte-3	Byte-4	Byte-5	Byte-6	Byte-7	Byte-8	Byte-9	Byte-10	Byte-11
Transaction identifier		Protocol identifier		Field length		Unit identifier	Function code	Register address		Word count	
X	X	0000 hex		0006 hex		FF hex	10 hex	B000 hex		0007 hex	

Parameter	Description
Register address	The register address from the command is set.
Word count	The word count from the command is set.

• Error Response

Byte-0	Byte-1	Byte-2	Byte-3	Byte-4	Byte-5	Byte-6	Byte-7	Byte-8
Transaction identifier		Protocol identifier		Field length		Unit identifier	Function code	Exception code
X	X	0000 hex		0003 hex		FF hex	90 hex	1 byte

Parameter	Description
Exception code	For details, refer to <i>Exception Code</i> on page 7-7 under <i>7-2-3 Response Format for Error Completion</i> on page 7-7.

● Execution Examples

Execution to Set the Following TCP/IP Communications Conditions in the Reader/Writer

IP address setting method: Fixed, IP address: 192.168.1.200, Subnet mask: 255.255.255.0, Gateway address: 192.168.1.1

TX: 000000000015FF10B00000070E0000C0A801C8FFFFFF00C0A80101

RX: 000000000006FF10B0000007

GET TCP/IP COMMUNICATIONS CONDITIONS

● Function

This command is used to check the TCP/IP communications conditions that are set in the Reader/Writer.

● Command Format

Byte-0	Byte-1	Byte-2	Byte-3	Byte-4	Byte-5	Byte-6	Byte-7	Byte-8	Byte-9	Byte-10	Byte-11
Transaction identifier		Protocol identifier		Field length		Unit identifier	Function code	Register address		Word count	
X	X	0000 hex		0006 hex		FF hex	03 hex	B000 hex		0007 hex	

Parameter	Description
Register address	The register address (B000 hex) that specifies the TCP/IP communications conditions.
Word count	The number of words of the TCP/IP communications conditions to read (0007 hex)

● Response Formats

- Normal Response

Byte-0	Byte-1	Byte-2	Byte-3	Byte-4	Byte-5	Byte-6	Byte-7	Byte-8
Transaction identifier		Protocol identifier		Field length		Unit identifier	Function code	Byte count
X	X	0000 hex		0011 hex		FF hex	03 hex	0E hex

Byte-9	Byte-10	Byte-11	...	Byte-14	Byte-15	...	Byte-18	Byte-19	...	Byte-22
TCP/IP communications conditions										
IP address setting method		IP address			Subnet mask			Gateway address		
2 bytes		4 bytes			4 bytes			4 bytes		

Parameter	Description	Default setting	
Byte count	The number of bytes in the TCP/IP communications conditions that were read (0E hex)		
TCP/IP communications conditions	IP address setting method	Gives the IP address setting method that was read in 4-digit hexadecimal. 0000 hex: Fixed setting 00001 hex: Obtain from BOOTP server 0002 hex: Get from BOOTP server as fixed settings	0000 hex
	IP address* ¹	Gives the IP address that was read in 8-digit hexadecimal. Example: C0A801C8 hex (192.168.1.200)	C0A801C8 hex
	Subnet mask* ¹	Gives the subnet mask that was read in 8-digit hexadecimal. Example: FFFFFFF0 hex (255.255.255.0)	FFFFFFF0 hex
	Gateway address* ¹	Gives the gateway address that was read in 8-digits hexadecimal. Example: C0A801FE hex (192.168.1.254)	C0A801FE hex

*1. For any IP address setting method except for using a fixed address, 00000000 hex is returned.

• Error Response

Byte-0	Byte-1	Byte-2	Byte-3	Byte-4	Byte-5	Byte-6	Byte-7	Byte-8
Transaction identifier		Protocol identifier		Field length		Unit identifier	Function code	Exception code
X	X	0000 hex		0003 hex		FF hex	83 hex	1 byte

Parameter	Description
Exception code	For details, refer to <i>Exception Code</i> on page 7-7 under <i>7-2-3 Response Format for Error Completion</i> on page 7-7.

● Execution Examples

Execution When the Following TCP/IP Communications Conditions Are Set in the Reader/Writer

IP address setting method: Fixed, IP address: 192.168.1.200, Subnet mask: 255.255.255.0, Gateway address: 192.168.1.1

TX: 000000000006FF03B0000007

RX: 00000000011FF030E0000C0A801C8FFFFFF00C0A80101

SET DEVICE NAME

● Function

This command is used to set or clear a name for the Reader/Writer.

● Command Format

Byte-0	Byte-1	Byte-2	Byte-3	Byte-4	Byte-5	Byte-6	Byte-7	Byte-8	Byte-9	Byte-10	Byte-11
Transaction identifier		Protocol identifier		Field length		Unit identifier	Function code	Register address		Word count	
X	X	0000 hex		0047 hex		FF hex	10 hex	B100 hex		0020 hex	

Byte-12	Byte-13	...	Byte-76
Byte count	Device name		
40 hex	64 bytes		

Parameter	Description
Register address	The register address (B100 hex) that specifies the device name
Word count	The number of words in the device name (0020 hex)
Byte count	The number of bytes in the device name (40 hex)
Device name	<p>ASCII characters, 64 bytes max. (63 ASCII characters max. + End code of 00 hex)</p> <p>If there are fewer than 63 characters, the remaining bytes are filled with 00 hex. The device name is given with ASCII characters 20 hex (space) to 7E hex (~).</p> <p>Specify 00 hex for all bytes to clear the device name.</p>

● Response Formats

• Normal Response

Byte-0	Byte-1	Byte-2	Byte-3	Byte-4	Byte-5	Byte-6	Byte-7	Byte-8	Byte-9	Byte-10	Byte-11
Transaction identifier		Protocol identifier		Field length		Unit identifier	Function code	Register address		Word count	
X	X	0000 hex		0006 hex		FF hex	10 hex	B100 hex		0020 hex	

Parameter	Description
Register address	The register address from the command is set.
Word count	The word count from the command is set.

• Error Response

Byte-0	Byte-1	Byte-2	Byte-3	Byte-4	Byte-5	Byte-6	Byte-7	Byte-8
Transaction identifier		Protocol identifier		Field length		Unit identifier	Function code	Exception code
X	X	0000 hex		0003 hex		FF hex	90 hex	1 byte

Parameter	Description
Exception code	For details, refer to <i>Exception Code</i> on page 7-7 under <i>Response Format for Error Completion</i> on page 7-7.

● **Execution Examples**

Execution to Set the Reader/Writer Device Name to V780-A001

TX: 000000000047FF10B10000204056363830532D413030310000000000...00

RX: 000000000006FF10B1000020

GET DEVICE NAME

● Function

This command is used to check the name that is set in the Reader/Writer.

● Command Format

Byte-0	Byte-1	Byte-2	Byte-3	Byte-4	Byte-5	Byte-6	Byte-7	Byte-8	Byte-9	Byte-10	Byte-11
Transaction identifier		Protocol identifier		Field length		Unit identifier	Function code	Register address		Word count	
X	X	0000 hex		0006 hex		FF hex	03 hex	B100 hex		0020 hex	

Parameter	Description
Register address	The register address (B100 hex) that specifies the device name
Word count	The number of words in the device name (0020 hex)

● Response Formats

• Normal Response

Byte-0	Byte-1	Byte-2	Byte-3	Byte-4	Byte-5	Byte-6	Byte-7	Byte-8	Byte-9	...	Byte-72
Transaction identifier		Protocol identifier		Field length		Unit identifier	Function code	Byte count	Device name		
X	X	0000 hex		0043 hex		FF hex	03 hex	40 hex	64 bytes		

Parameter	Description
Byte count	The number of words in the device name that was read (40 hex)
Device name	The device name that was read is given with up to 64 bytes of ASCII characters (up to 63 ASCII characters plus the end code (00 hex)) If there are fewer than 63 characters, the remaining bytes are filled with 00 hex. The device name is given with ASCII characters 20 hex (space) to 7E hex (~).

• Error Response

Byte-0	Byte-1	Byte-2	Byte-3	Byte-4	Byte-5	Byte-6	Byte-7	Byte-8
Transaction identifier		Protocol identifier		Field length		Unit identifier	Function code	Exception code
X	X	0000 hex		0003 hex		FF hex	83 hex	1 byte

Parameter	Description
Exception code	For details, refer to <i>Exception Code</i> on page 7-7 under <i>7-2-3 Response Format for Error Completion</i> on page 7-7.

● Execution Examples

Execution When the Reader/Writer Device Name Is Set to V780-A001

TX: 000000000006FF03B1000020

RX: 000000000043FF034056363830532D41303031000000000...00

SET MODBUS/TCP COMMUNICATIONS CONDITIONS

● Function

This command sets the Modbus/TCP communications conditions of the Reader/Writer.

● Command Format

Byte-0	Byte-1	Byte-2	Byte-3	Byte-4	Byte-5	Byte-6	Byte-7	Byte-8	Byte-9	Byte-10	Byte-11
Transaction identifier		Protocol identifier		Field length		Unit identifier	Function code	Register address		Word count	
X	X	0000 hex		0009 hex		FF hex	10 hex	B200 hex		0001 hex	

Byte-12	Byte-13	Byte-14
Byte count	Modbus/TC communications conditions	
	Port number	
02 hex	2 bytes	

Parameter	Description	Default setting
Register address	The register address (B200 hex) that specifies the Modbus/TCP communications conditions	
Word count	The number of words in the Modbus/TCP communications conditions (0001 hex)	
Byte count	The number of bytes in the Modbus/TCP communications conditions (02 hex)	
Modbus/TC communications conditions	Specify the Modbus/TCP communications port number in 4-digit hexadecimal. Setting range: 01F6 hex or 0400 to FFFF hex Example: 01F6 hex (502) <ul style="list-style-type: none"> IANA manages ports 000 to 03FF hex. 	01F6 hex (502)

● Response Formats

• Normal Response

Byte-0	Byte-1	Byte-2	Byte-3	Byte-4	Byte-5	Byte-6	Byte-7	Byte-8	Byte-9	Byte-10	Byte-11
Transaction identifier		Protocol identifier		Field length		Unit identifier	Function code	Register address		Word count	
X	X	0000 hex		0006 hex		FF hex	10 hex	B200 hex		0001 hex	

Parameter	Description
Register address	The register address from the command is set.
Word count	The word count from the command is set.

• Error Response

Byte-0	Byte-1	Byte-2	Byte-3	Byte-4	Byte-5	Byte-6	Byte-7	Byte-8
Transaction identifier		Protocol identifier		Field length		Unit identifier	Function code	Exception code
X	X	0000 hex		0003 hex		FF hex	90 hex	1 byte

Parameter	Description
Exception code	For details, refer to <i>Exception Code</i> on page 7-7 under <i>Response Format for Error Completion</i> on page 7-7.

- **Execution Examples**

Execution to Set the Following Modbus/TCP Communications Conditions in the Reader/Writer
Port number: 502

TX: 000000000009FF10B20000010201F6

RX: 000000000006FF10B2000001

GET MODBUS/TCP COMMUNICATIONS CONDITIONS

● Function

This command is used to check the Modbus/TCP communications conditions of the Reader/Writer.

● Command Format

Byte-0	Byte-1	Byte-2	Byte-3	Byte-4	Byte-5	Byte-6	Byte-7	Byte-8	Byte-9	Byte-10	Byte-11
Transaction identifier		Protocol identifier		Field length		Unit identifier	Function code	Register address		Word count	
X	X	0000 hex		0006 hex		FF hex	03 hex	B200 hex		0001 hex	

Parameter	Description	Default setting
Register address	The register address (B200 hex) that specifies the Modbus/TCP communications conditions	
Word count	The number of words of the Modbus/TCP communications conditions to read (0001 hex)	

● Response Formats

• Normal Response

Byte-0	Byte-1	Byte-2	Byte-3	Byte-4	Byte-5	Byte-6	Byte-7	Byte-8	Byte-9	Byte-10
Transaction identifier		Protocol identifier		Field length		Unit identifier	Function code	Byte count	Modbus/TC communications conditions	
X	X	0000 hex		0005 hex		FF hex	03 hex	02 hex	Port number	
										2 bytes

Parameter	Description
Byte count	The number of bytes in the Modbus/TCP communications conditions that were read (02 hex)
Modbus/TC communications conditions	Port number Gives the Modbus/TCP communications port number in 4-digit hexadecimal. Example: 01F6 hex (502)

• Error Response

Byte-0	Byte-1	Byte-2	Byte-3	Byte-4	Byte-5	Byte-6	Byte-7	Byte-8
Transaction identifier		Protocol identifier		Field length		Unit identifier	Function code	Exception code
X	X	0000 hex		0003 hex		FF hex	83 hex	1 byte

Parameter	Description
Exception code	For details, refer to <i>Exception Code</i> on page 7-7 under <i>7-2-3 Response Format for Error Completion</i> on page 7-7.

● Execution Examples

Execution When the Following Modbus/TCP Communications Conditions Are Set in the Reader/Writer

Port number: 502

TX: 000000000006FF03B2000001

RX: 000000000005FF030201F6

SET WEB COMMUNICATIONS CONDITIONS

● Function

This command sets the Web browser communications conditions of the Reader/Writer.

● Command Format

Byte-0	Byte-1	Byte-2	Byte-3	Byte-4	Byte-5	Byte-6	Byte-7	Byte-8	Byte-9	Byte-10	Byte-11
Transaction identifier		Protocol identifier		Field length		Unit identifier	Function code	Register address		Word count	
X	X	0000 hex		0009 hex		FF hex	10 hex	B300 hex		0001 hex	

Byte-12	Byte-13	Byte-14
Byte count	Web communications conditions	
	Port number	
02 hex	2 bytes	

Parameter	Description	Default setting
Register address	The register address (B300 hex) that specifies the Web communications conditions	
Word count	The number of words in the Web communications conditions (0001 hex)	
Byte count	The number of bytes in the Web communications conditions (02 hex)	
Web communications conditions	Specify the Web communications port number in 4-digit hexadecimal. Setting range: 0400 to FFFF hex Example: 1BB2 hex (7090) • IANA manages ports 000 to 03FF hex.	1BB2 hex (7090)

● Response Formats

• Normal Response

Byte-0	Byte-1	Byte-2	Byte-3	Byte-4	Byte-5	Byte-6	Byte-7	Byte-8	Byte-9	Byte-10	Byte-11
Transaction identifier		Protocol identifier		Field length		Unit identifier	Function code	Register address		Word count	
X	X	0000 hex		0006 hex		FF hex	10 hex	B300 hex		0001 hex	

Parameter	Description
Register address	The register address from the command is set.
Word count	The word count from the command is set.

• Error Response

Byte-0	Byte-1	Byte-2	Byte-3	Byte-4	Byte-5	Byte-6	Byte-7	Byte-8
Transaction identifier		Protocol identifier		Field length		Unit identifier	Function code	Exception code
X	X	0000 hex		0003 hex		FF hex	90 hex	1 byte

Parameter	Description
Exception code	For details, refer to <i>Exception Code</i> on page 7-7 under <i>7-2-3 Response Format for Error Completion</i> on page 7-7.

● Execution Examples

Execution to Set the Following Web Communications Conditions in the Reader/Writer

Port number: 7090

TX: 000000000009FF10B3000001021BB2

RX: 000000000006FF10B3000001

GET WEB COMMUNICATIONS CONDITIONS

● Function

This command is used to check the Web browser communications conditions of the Reader/Writer.

● Command Format

Byte-0	Byte-1	Byte-2	Byte-3	Byte-4	Byte-5	Byte-6	Byte-7	Byte-8	Byte-9	Byte-10	Byte-11
Transaction identifier		Protocol identifier		Field length		Unit identifier	Function code	Register address		Word count	
X	X	0000 hex		0006 hex		FF hex	03 hex	B300 hex		0001 hex	

Parameter	Description
Register address	The register address (B300 hex) that specifies the Web communications conditions
Word count	The number of words of the Web communications conditions to read (0001 hex)

● Response Formats

• Normal Response

Byte-0	Byte-1	Byte-2	Byte-3	Byte-4	Byte-5	Byte-6	Byte-7	Byte-8	Byte-9	Byte-10
Transaction identifier		Protocol identifier		Field length		Unit identifier	Function code	Byte count	Web communications conditions	
X	X	0000 hex		0005 hex		FF hex	03 hex	02 hex	Port number	
										2 bytes

Parameter	Description
Byte count	The number of bytes in the Web communications conditions that were read (02 hex)
Web communications conditions	Port number Gives the Web communications port number that was read in 4-digit hexadecimal. Example: 1BB2 hex (7090)

• Error Response

Byte-0	Byte-1	Byte-2	Byte-3	Byte-4	Byte-5	Byte-6	Byte-7	Byte-8
Transaction identifier		Protocol identifier		Field length		Unit identifier	Function code	Exception code
X	X	0000 hex		0003 hex		FF hex	83 hex	1 byte

Parameter	Description
Exception code	For details, refer to <i>Exception Code</i> on page 7-7 under <i>7-2-3 Response Format for Error Completion</i> on page 7-7.

● Execution Examples

Execution When the Following Web Communications Conditions Are Set in the Reader/Writer
Port number: 7090

TX: 000000000006FF03B3000001

RX: 000000000005FF03021BB2

SET WEB PASSWORD

● Function

This command sets or clears the Reader/Writer login password for the Web browser interface.

● Command Format

Byte-0	Byte-1	Byte-2	Byte-3	Byte-4	Byte-5	Byte-6	Byte-7	Byte-8	Byte-9	Byte-10	Byte-11
Transaction identifier		Protocol identifier		Field length		Unit identifier	Function code	Register address		Word count	
X	X	0000 hex		0017 hex		FF hex	10 hex	B400 hex		0008 hex	

Byte-12	Byte-13	...	Byte-28
Byte count	Web password		
10 hex	16 bytes		

Parameter	Description
Register address	The register address (B400 hex) that specifies the Web password
Word count	The number of words in the Web password (0008 hex)
Byte count	The number of bytes in the Web password (10 hex)
Web password	Specify the Web password with up to 16 bytes of ASCII characters (up to 15 ASCII characters plus the end code (00 hex)). If there are fewer than 15 characters, fill the remaining bytes with 00 hex. You can specify ASCII characters 20 hex (space) to 7E hex (~). To clear the password, specify 00 hex for all of the write data.

● Response Formats

• Normal Response

Byte-0	Byte-1	Byte-2	Byte-3	Byte-4	Byte-5	Byte-6	Byte-7	Byte-8	Byte-9	Byte-10	Byte-11
Transaction identifier		Protocol identifier		Field length		Unit identifier	Function code	Register address		Word count	
X	X	0000 hex		0006 hex		FF hex	10 hex	B400 hex		0008 hex	

Parameter	Description
Register address	The register address from the command is set.
Word count	The word count from the command is set.

• Error Response

Byte-0	Byte-1	Byte-2	Byte-3	Byte-4	Byte-5	Byte-6	Byte-7	Byte-8
Transaction identifier		Protocol identifier		Field length		Unit identifier	Function code	Exception code
X	X	0000 hex		0003 hex		FF hex	90 hex	1 byte

Parameter	Description
Exception code	For details, refer to <i>Exception Code</i> on page 7-7 under <i>7-2-3 Response Format for Error Completion</i> on page 7-7.

- **Execution Examples**

Setting the Reader/Writer Web Password to “password”

TX: 000000000017FF10B40000081070617373776F72640000000000000000

RX: 000000000006FF10B4000008

GET WEB PASSWORD

● Function

This command is used to check the login password that is set in the Reader/Writer for the Web browser interface.

● Command Format

Byte-0	Byte-1	Byte-2	Byte-3	Byte-4	Byte-5	Byte-6	Byte-7	Byte-8	Byte-9	Byte-10	Byte-11
Transaction identifier		Protocol identifier		Field length		Unit identifier	Function code	Register address		Word count	
X	X	0000 hex		0006 hex		FF hex	03 hex	B400 hex		0008 hex	

Parameter	Description
Register address	The register address (B400 hex) that specifies the Web password
Word count	The number of words in the Web password (0008 hex)

● Response Formats

• Normal Response

Byte-0	Byte-1	Byte-2	Byte-3	Byte-4	Byte-5	Byte-6	Byte-7	Byte-8	Byte-9	...	Byte-24
Transaction identifier		Protocol identifier		Field length		Unit identifier	Function code	Byte count	Web password		
X	X	0000 hex		0013 hex		FF hex	03 hex	10 hex	16 bytes		

Parameter	Description
Byte count	The number of bytes in the Web password that was read (10 hex)
Web password	Gives the Web password that was read with up to 16 bytes of ASCII characters (up to 15 ASCII characters plus the end code (00 hex)). If there are fewer than 15 characters, the remaining bytes are filled with 00 hex. The Web password is given with ASCII characters 20 hex (space) to 7E hex (~).

• Error Response

Byte-0	Byte-1	Byte-2	Byte-3	Byte-4	Byte-5	Byte-6	Byte-7	Byte-8
Transaction identifier		Protocol identifier		Field length		Unit identifier	Function code	Exception code
X	X	0000 hex		0003 hex		FF hex	83 hex	1 byte

Parameter	Description
Exception code	For details, refer to <i>Exception Code</i> on page 7-7 under <i>7-2-3 Response Format for Error Completion</i> on page 7-7.

● Execution Examples

Execution When the Reader/Writer Web Password Is Set to "password"

TX: 000000000006FF03B4000008

RX: 000000000013FF031070617373776F72640000000000000000

7-6-6 Reader/Writer Setting Commands: Communications Settings

SET TAG COMMUNICATIONS CONDITIONS

● Function

This command sets the communications conditions for the Reader/Writer.

● Command Format

Byte-0	Byte-1	Byte-2	Byte-3	Byte-4	Byte-5	Byte-6	Byte-7	Byte-8	Byte-9	Byte-10	Byte-11
Transaction identifier		Protocol identifier		Field length		Unit identifier	Function code	Register address		Word count	
X	X	0000 hex		0011 hex		FF hex	10 hex	C000 hex		0005 hex	

Byte-12	Byte-13	Byte-14	Byte-15	Byte-16	Byte-17	Byte-18	Byte-19	Byte-20	Byte-21	Byte-22
Byte count	Communications conditions									
0A hex	RF communications mode	RF communications speed		RF communications timeout time		Write verification		RF communications diagnostic		
	2 bytes	2 bytes		2 bytes		2 bytes		2 bytes		

Parameter		Description	Default setting
Register address		The register address (C000 hex) that specifies the RF communications conditions	
Word count		The number of words in the RF communications conditions (0005 hex)	
Byte count		The number of bytes in the RF communications conditions (0A hex)	
Communications conditions	RF communications mode	Specify the communications mode in 4-digit hexadecimal. 0000 hex: Once 0001 hex: Auto 0002 hex: Focus	0000 hex
	RF communications speed	Specify the communications speed in 4-digit hexadecimal. 0000 hex: Automatic (default) 0001 hex: High speed 0002 hex: Normal speed	0000 hex
	RF communications timeout time	Specify the RF communications timeout time. 0001 to EA60 hex (1 to 60,000 [ms])	00FA hex (250)
	Write verification	Specify in 4-digit hexadecimal whether to perform write verification. 0000 hex: Disable, 0001 hex: Enable	0001 hex
	RF communications diagnostic	Specify in 4-digit hexadecimal whether to perform diagnostic 0000 hex: Disable, 0001 hex: Enable	0000 hex

● Response Formats

- Normal Response

Byte-0	Byte-1	Byte-2	Byte-3	Byte-4	Byte-5	Byte-6	Byte-7	Byte-8	Byte-9	Byte-10	Byte-11
Transaction identifier		Protocol identifier		Field length		Unit identifier	Function code	Register address		Word count	
X	X	0000 hex		0006 hex		FF hex	10 hex	C000 hex		0005 hex	

Parameter	Description
Register address	The register address from the command is set.

Parameter	Description
Word count	The word count from the command is set.

• Error Response

Byte-0	Byte-1	Byte-2	Byte-3	Byte-4	Byte-5	Byte-6	Byte-7	Byte-8
Transaction identifier	Protocol identifier		Field length		Unit identifier	Function code	Exception code	
X	X	0000 hex		0003 hex		FF hex	90 hex	1 byte

Parameter	Description
Exception code	For details, refer to <i>Exception Code</i> on page 7-7 under <i>7-2-3 Response Format for Error Completion</i> on page 7-7.

● Execution Examples

Execution to Set the Following RF Communications Conditions in the Reader/Writer

RF communications mode: Once, RF communications speed: Auto, RF communications timeout time: 250 ms, Write verification: Enabled, RF communications diagnostic: Enabled

TX: 000000000011FF10C00000050A000000000FA00010001

RX: 000000000006FF10C0000005

GET TAG COMMUNICATIONS CONDITIONS

● Function

This command is used to check the RF communications conditions that are set in the Reader/Writer.

● Command Format

Byte-0	Byte-1	Byte-2	Byte-3	Byte-4	Byte-5	Byte-6	Byte-7	Byte-8	Byte-9	Byte-10	Byte-11
Transaction identifier		Protocol identifier		Field length		Unit identifier	Function code	Register address		Word count	
X	X	0000 hex		0006 hex		FF hex	03 hex	C000 hex		0005 hex	

Parameter	Description
Register address	The register address (C000 hex) that specifies the RF communications conditions
Word count	The number of words of the RF communications conditions to read (0005 hex)

● Response Formats

- Normal Response

Byte-0	Byte-1	Byte-2	Byte-3	Byte-4	Byte-5	Byte-6	Byte-7	Byte-8
Transaction identifier		Protocol identifier		Field length		Unit identifier	Function code	Byte count
X	X	0000 hex		000D hex		FF hex	03 hex	0A hex

Byte-9	Byte-10	Byte-11	Byte-12	Byte-13	Byte-14	Byte-15	Byte-16	Byte-17	Byte-18
Communications conditions									
RF communications mode		RF communications speed		RF communications timeout time		Write verification		RF communications diagnostic	
2 bytes		2 bytes		2 bytes		2 bytes		2 bytes	

Parameter	Description	Default setting
Register address	The register address (C000 hex) that specifies the RF communications conditions	
Word count	The number of words in the RF communications conditions (0005 hex)	
Byte count	The number of bytes in the RF communications conditions (0A hex)	

Parameter		Description	Default setting
Communica- tions conditions	RF communica- tions mode	Gives the communications mode in 4-digit hexadecimal. 0000 hex: Once 0001 hex: Auto 0002 hex: Focus	0000 hex
	RF communica- tions speed	Gives the communications speed in 4-digit hexadecimal. 0000 hex: Automatic (default) 0001 hex: High speed 0002 hex: Normal speed	0000 hex
	RF communica- tions timeout time	Gives the RF communications timeout time. 0001 to EA60 hex (1 to 60,000 [ms])	00FA hex (250)
	Write verification	Gives whether write verification is being performed in 4-digit hexadecimal. 0000 hex: Disable, 0001 hex: Enable	0001 hex
	RF communica- tions diagnostic	Gives whether diagnostic is being performed in 4-digit hexadecimal. 0000 hex: Disable, 0001 hex: Enable	0000 hex

• Error Response

Byte-0	Byte-1	Byte-2	Byte-3	Byte-4	Byte-5	Byte-6	Byte-7	Byte-8
Transaction identi- fier		Protocol identifier		Field length		Unit identifier	Function code	Excep- tion code
X	X	0000 hex		0003 hex		FF hex	83 hex	1 byte

Parameter	Description
Exception code	For details, refer to <i>Exception Code</i> on page 7-7 under <i>7-2-3 Response Format for Error Completion</i> on page 7-7.

● Execution Examples

Execution When the Following RF Communications Conditions Are Set in the Reader/Writer

RF communications mode: Once, RF communications speed: Auto, RF communications timeout time: 250 ms, Write verification: Enabled, RF communications diagnostic: Enabled

TX: 000000000006FF03C0000005

RX: 0000000000DFF030A000000000FA00010001

SET TRANSMISSION POWER

● Function

This command sets the transmission powers of the Reader/Writer.

● Command Format

Byte-0	Byte-1	Byte-2	Byte-3	Byte-4	Byte-5	Byte-6	Byte-7	Byte-8	Byte-9	Byte-10	Byte-11	Byte-12
Transaction identifier		Protocol identifier		Field length		Unit identifier	Function code	Register address		Word count		Byte count
X	X	0000 hex		2 bytes		FF hex	10 hex	C100 hex		2 bytes		1 byte

Byte-13	Byte-14	Byte-15	Byte-16	Byte-17	Byte-18	Byte-19	Byte-20	...	Byte-41	Byte-42	Byte-43	Byte-44
Transmission power												
Master Reader/Writer (Reader/Writer Number 0)				Slave Reader/Writer 1 (Reader/Writer Number 1)				...	Slave Reader/Writer 7 (Reader/Writer Number 7)			
Read transmission power		Write transmission power		Read transmission power		Write transmission power		...	Read transmission power		Write transmission power	
2 bytes		2 bytes		2 bytes		2 bytes		...	2 bytes		2 bytes	

Parameter	Description	Default setting
Field length	Setting range: 000B to 0027 hex 7 bytes + Number of Readers/Writers × 4 bytes	
Register address	The register address (C100 hex) that specifies setting the transmission powers	
Word count	Number of words in the obtained transmission power settings 0002 hex: Obtains the transmission power of the Master Reader/Writer 0004 hex: Obtains the transmission power of the Master Reader/Writer and Slave Reader/Writer 1 0006 hex: Obtains the transmission power of the Master Reader/Writer and Slave Reader/Writer 1 to 2 : : : 000E hex: Obtains the transmission power of the Master Reader/Writer and Slave Reader/Writer 1 to 6 0010 hex: Obtains the transmission power of the Master Reader/Writer and Slave Reader/Writer 1 to 7 Number of Readers/Writers × 2 words	
Byte count	The number of bytes in the transmission powers 04 hex: Obtains the transmission power of the Master Reader/Writer 08 hex: Obtains the transmission power of the Master Reader/Writer and Slave Reader/Writer 1 0C hex: Obtains the transmission power of the Master Reader/Writer and Slave Reader/Writer 1 to 2 : : : 1C hex: Obtains the transmission power of the Master Reader/Writer and Slave Reader/Writer 1 to 6 20 hex: Obtains the transmission power of the Master Reader/Writer and Slave Reader/Writer 1 to 7 Number of Readers/Writers × 4 bytes	

Parameter		Description	Default setting
Transmission power	Read transmission power	Specify the transmission power for read RF communications commands in 4-digit hexadecimal. 000F to 001B hex (15 to 27 dBm)	001B hex (27 [dBm])
	Write transmission power	Specify the transmission power for write RF communications commands in 4-digit hexadecimal. 000F to 001B hex (15 to 27 dBm)	001B hex (27 [dBm])

● Response Formats

- Normal Response

Byte-0	Byte-1	Byte-2	Byte-3	Byte-4	Byte-5	Byte-6	Byte-7	Byte-8	Byte-9	Byte-10	Byte-11
Transaction identifier		Protocol identifier		Field length		Unit identifier	Function code	Register address		Word count	
X	X	0000 hex		0006 hex		FF hex	10 hex	C100 hex		0002 hex	

Parameter	Description
Register address	The register address from the command is set.
Word count	The word count from the command is set.

- Error Response

Byte-0	Byte-1	Byte-2	Byte-3	Byte-4	Byte-5	Byte-6	Byte-7	Byte-8
Transaction identifier		Protocol identifier		Field length		Unit identifier	Function code	Exception code
X	X	0000 hex		0003 hex		FF hex	90 hex	1 byte

Parameter	Description
Exception code	For details, refer to <i>Exception Code</i> on page 7-7 under <i>7-2-3 Response Format for Error Completion</i> on page 7-7.

● Execution Examples

- Example 1) Execution to Set the Following Transmission Powers in the Reader/Writer
Read transmission power: 27 dBm, Write transmission power: 27 dBm

TX: 0000000000BFF10C100000204001B001B

RX: 00000000006FF10C1000002

- Example 2) Execution to Set the Following Transmission Powers in the Reader/Writer

Reader/Writer	Read transmission power	Write transmission power
Master Reader/Writer	27 dBm	27 dBm
Slave Reader/Writer 1	26 dBm	26 dBm
Slave Reader/Writer 2	25 dBm	25 dBm
Slave Reader/Writer 3	24 dBm	24 dBm

TX: 00000000017FF10C100000810001B001B001A001A0019001900180018

RX: 00000000006FF10C1000008

GET TRANSMISSION POWER

● Function

This command is used to check the transmission powers that are set in the Reader/Writer.

● Command Format

Byte-0	Byte-1	Byte-2	Byte-3	Byte-4	Byte-5	Byte-6	Byte-7	Byte-8	Byte-9	Byte-10	Byte-11
Transaction identifier		Protocol identifier		Field length		Unit identifier	Function code	Register address		Word count	
X	X	0000 hex		0006 hex		FF hex	03 hex	C100 hex		2 bytes	

Parameter	Description
Register address	The register address (C100 hex) that specifies setting the transmission power
Word count	Number of words in the obtained transmission power settings 0002 hex: Obtains the transmission power of the Master Reader/Writer 0004 hex: Obtains the transmission power of the Master Reader/Writer and Slave Reader/Writer 1 0006 hex: Obtains the transmission power of the Master Reader/Writer and Slave Reader/Writer 1 to 2 ⋮ 000E hex: Obtains the transmission power of the Master Reader/Writer and Slave Reader/Writer 1 to 6 0010 hex: Obtains the transmission power of the Master Reader/Writer and Slave Reader/Writer 1 to 7 Number of Readers/Writers × 2 words

● Response Formats

- Normal Response

Byte-0	Byte-1	Byte-2	Byte-3	Byte-4	Byte-5	Byte-6	Byte-7	Byte-8
Transaction identifier		Protocol identifier		Field length		Unit identifier	Function code	Byte count
X	X	0000 hex		2 bytes		FF hex	03 hex	1 byte

Byte-9	Byte-10	Byte-11	Byte-12	Byte-13	Byte-14	Byte-15	Byte-16	...	Byte-37	Byte-38	Byte-39	Byte-40
Transmission power												
Master Reader/Writer (Reader/Writer Number 0)				Slave Reader/Writer 1 (Reader/Writer Number 1)				...	Slave Reader/Writer 7 (Reader/Writer Number 7)			
Read transmission power		Write transmission power		Read transmission power		Write transmission power		...	Read transmission power		Write transmission power	
2 bytes		2 bytes		2 bytes		2 bytes		...	2 bytes		2 bytes	

Parameter		Description	Default setting
Field length		Gives the total number of bytes starting from the unit identifier in 4-digit hexadecimal. 07 to 23 hex 3 + Number of Readers/Writers × 4 bytes	
Byte count		The number of bytes in the transmission powers 04 hex: Obtains the transmission power of the Master Reader/Writer 08 hex: Obtains the transmission power of the Master Reader/Writer and Slave Reader/Writer 1 0C hex: Obtains the transmission power of the Master Reader/Writer and Slave Reader/Writer 1 to 2 ⋮ 1C hex: Obtains the transmission power of the Master Reader/Writer and Slave Reader/Writer 1 to 6 20 hex: Obtains the transmission power of the Master Reader/Writer and Slave Reader/Writer 1 to 7 Number of Readers/Writers × 4 bytes	
Transmission power	Read transmission power	Gives the transmission power for read RF communications commands in 4-digit hexadecimal. 000F to 001B hex (15 to 27 dBm)	001B hex (27 [dBm])
	Write transmission power	Gives the transmission power for write RF communications commands in 4-digit hexadecimal. 000F to 001B hex (15 to 27 dBm)	001B hex (27 [dBm])

● Execution Examples

Example 1) Execution When the Following RF Transmission Powers Are Set in the Reader/Writer
Read transmission power: 27 dBm, Write transmission power: 27dBm

TX: 000000000006FF03C1000002
RX: 000000000007FF0304001B001B

Example 2) Execution When the Following RF Transmission Powers Are Set in the Reader/Writer

Reader/Writer	Read transmission power	Write transmission power
Master Reader/Writer	27 dBm	27 dBm
Slave Reader/Writer 1	26 dBm	26 dBm
Slave Reader/Writer 2	25 dBm	25 dBm
Slave Reader/Writer 3	24 dBm	24 dBm

TX: 000000000006FF03C1000008
RX: 000000000013FF0310001B001B001A001A0019001900180018

SET CHANNEL

● Function

This command sets the channel for the Reader/Writer.

● Command Format

Byte-0	Byte-1	Byte-2	Byte-3	Byte-4	Byte-5	Byte-6	Byte-7	Byte-8	Byte-9	Byte-10	Byte-11
Transaction identifier		Protocol identifier		Field length		Unit identifier	Function code	Register address		Word count	
X	X	0000 hex		0009 hex		FF hex	10 hex	C200 hex		0001hex	

Byte-12	Byte-13	Byte-14
Byte count	Channel	
02 hex	2 bytes	

Parameter	Description	Default setting
Register address	Register address (C200 hex) that specifies the channel	
Channel* ¹	Specify the channel in 4-digit hexadecimal.	0000 hex
V780-HMD68-ETN-JP	0000 hex: Automatic 0005 hex: 5CH 000B hex: 11CH 0011 hex: 17CH	
V780-HMD68-ETN-IN	0000 hex: Automatic 0004 hex: 4CH 0007 hex: 7CH 000A hex: 10CH	
V780-HMD68-ETN-EU	0000 hex: Automatic 0004 hex: 4CH 0007 hex: 7CH 000A hex: 10CH 000D hex: 13CH	
V780-HMD68-ETN-RU	0000 hex: Automatic 0007 hex: 7CH 000A hex: 10CH 000D hex: 13CH	

*1. The channel used can only be specified in models V780-HMD68-ETN-JP/-IN/-EU/-RU. The channel cannot be specified in the other models.

● Response Formats

- Normal Response

Byte-0	Byte-1	Byte-2	Byte-3	Byte-4	Byte-5	Byte-6	Byte-7	Byte-8	Byte-9	Byte-10	Byte-11
Transaction identifier		Protocol identifier		Field length		Unit identifier	Function code	Register address		Word count	
X	X	0000 hex		0006 hex		FF hex	10 hex	C200 hex		0001 hex	

Parameter	Description
Register address	The register address from the command is set.
Word count	The word count from the command is set.

• Error Response

Byte-0	Byte-1	Byte-2	Byte-3	Byte-4	Byte-5	Byte-6	Byte-7	Byte-8
Transaction identifier		Protocol identifier		Field length		Unit identifier	Function code	Exception code
X	X	0000 hex		0003 hex		FF hex	90 hex	1 byte

Parameter	Description
Exception code	For details, refer to <i>Exception Code</i> on page 7-7 under <i>Response Format for Error Completion</i> on page 7-7.

● Execution Examples

-JP: When “5CH” is set as the channel for the Reader/Writer.

TX: 000000000009FF10C2000001020005

RX: 000000000006FF10C2000001

GET CHANNEL

● Function

This command writes the ID (i.e., the UII (EPC code)) to the RF Tag in the communications range.

● Command Format

Byte-0	Byte-1	Byte-2	Byte-3	Byte-4	Byte-5	Byte-6	Byte-7	Byte-8	Byte-9	Byte-10	Byte-11
Transaction identifier		Protocol identifier		Field length		Unit identifier	Function code	Register address		Word count	
X	X	0000 hex		0006 hex		FF hex	03 hex	C200 hex		1 byte	

Parameter	Description
Register address	Register address (C200 hex) that specifies the channel
Word count	0001 hex (Fixed)

● Response Formats

- Normal Response

Byte-0	Byte-1	Byte-2	Byte-3	Byte-4	Byte-5	Byte-6	Byte-7	Byte-8	Byte-9	Byte-10
Transaction identifier		Protocol identifier		Field length		Unit identifier	Function code	Byte count	Channel	
X	X	0000 hex		0005 hex		FF hex	03 hex	02 hex	2 bytes	

Parameter	Description	Default setting
Field Length	0005 hex (Fixed)	
Byte count	02 hex (Fixed)	
Channel*1	Specify the channel in 4-digit hexadecimal.	0000 hex
V780-HMD68-ETN-JP	0000 hex: Automatic 0005 hex: 5CH 000B hex: 11CH 0011 hex: 17CH	
V780-HMD68-ETN-IN	0000 hex: Automatic 0004 hex: 4CH 0007 hex: 7CH 000A hex: 10CH	
V780-HMD68-ETN-EU	0000 hex: Automatic 0004 hex: 4CH 0007 hex: 7CH 000A hex: 10CH 000D hex: 13CH	
V780-HMD68-ETN-RU	0000 hex: Automatic 0007 hex: 7CH 000A hex: 10CH 000D hex: 13CH	

*1. You can specify only the channels used in the model V780-HMD68-ETN-JP/-IN/-EU/-RU. You cannot specify the channel in other models.

- Error Response

Byte-0	Byte-1	Byte-2	Byte-3	Byte-4	Byte-5	Byte-6	Byte-7	Byte-8
Transaction identifier		Protocol identifier		Field length		Unit identifier	Function code	Exception code
X	X	0000 hex		0003 hex		FF hex	83 hex	1 byte

Parameter	Description
Exception code	For details, refer to <i>Exception Code</i> on page 7-7 under <i>Response Format for Error Completion</i> on page 7-7.

- Execution Examples

-JP: When "5CH" is set as the channel for the Reader/Writer.

TX: 000000000006FF03C2000001

RX: 000000000005FF03020005

SET GEN2 SESSION

● Function

This command sets the Gen2 session for the Reader/Writer.

● Command Format

Byte-0	Byte-1	Byte-2	Byte-3	Byte-4	Byte-5	Byte-6	Byte-7	Byte-8	Byte-9	Byte-10	Byte-11
Transaction identifier		Protocol identifier		Field length		Unit identifier	Function code	Register address		Word count	
X	X	0000 hex		009 hex		FF hex	10 hex	C300 hex		0001 hex	

Byte-12	Byte-13	Byte-14
Byte count	Gen2 Session	
02 hex	2 bytes	

Parameter	Description	Default setting
Register address	The register address (C300 hex) that specifies the Gen2 session setting	
Word count	The number of words in the Gen2 session setting (0001 hex)	
Byte count	The number of bytes in the Gen2 session setting (02 hex)	
Gen2 session	Specify the session to use for RF Tag communications in 4-digit hexadecimal. 0000 hex: S0 flag 0001 hex: S1 flag 0002 hex: S2 flag 0003 hex: S3 flag	0000 hex

● Response Formats

• Normal Response

Byte-0	Byte-1	Byte-2	Byte-3	Byte-4	Byte-5	Byte-6	Byte-7	Byte-8	Byte-9	Byte-10	Byte-11
Transaction identifier		Protocol identifier		Field length		Unit identifier	Function code	Register address		Word count	
X	X	0000 hex		0006 hex		FF hex	10 hex	C300 hex		0001 hex	

Parameter	Description
Register address	The register address from the command is set.
Word count	The word count from the command is set.

• Error Response

Byte-0	Byte-1	Byte-2	Byte-3	Byte-4	Byte-5	Byte-6	Byte-7	Byte-8
Transaction identifier		Protocol identifier		Field length		Unit identifier	Function code	Exception code
X	X	0000 hex		0003 hex		FF hex	90 hex	1 byte

Parameter	Description
Exception code	For details, refer to <i>Exception Code</i> on page 7-7 under <i>7-2-3 Response Format for Error Completion</i> on page 7-7.

● **Execution Examples**

Execution to Set S2 as the Gen2 Session for the Reader/Writer

TX: 000000000009FF10C3000001020002

RX: 000000000006FF10C3000001

GET GEN2 SESSION

● Function

This command is used to check the Gen2 session that is set in the Reader/Writer.

● Command Format

Byte-0	Byte-1	Byte-2	Byte-3	Byte-4	Byte-5	Byte-6	Byte-7	Byte-8	Byte-9	Byte-10	Byte-11
Transaction identifier		Protocol identifier		Field length		Unit identifier	Function code	Register address		Word count	
X	X	0000 hex		0006 hex		FF hex	03 hex	C300 hex		0001 hex	

Parameter	Description
Register address	The register address (C300 hex) that specifies the Gen2 session setting
Word count	The number of words in the Gen2 session setting to read (0001 hex)

● Response Formats

- Normal Response

Byte-0	Byte-1	Byte-2	Byte-3	Byte-4	Byte-5	Byte-6	Byte-7	Byte-8	Byte-9	Byte-10
Transaction identifier		Protocol identifier		Field length		Unit identifier	Function code	Byte count	Gen2 session	
X	X	0000 hex		0005 hex		FF hex	03 hex	02 hex	2 bytes	

Parameter	Description	Default setting
Byte count	The number of bytes in the Gen2 session setting that was read (02 hex)	
Gen2 session	Gives the session that is being used for RF Tag communications in 4-digit hexadecimal. 0000 hex: S0 flag (default) 0001 hex: S1 flag 0002 hex: S2 flag 0003 hex: S3 flag	0000 hex

- Error Response

Byte-0	Byte-1	Byte-2	Byte-3	Byte-4	Byte-5	Byte-6	Byte-7	Byte-8
Transaction identifier		Protocol identifier		Field length		Unit identifier	Function code	Exception code
X	X	0000 hex		0003 hex		FF hex	83 hex	1 byte

Parameter	Description
Exception code	For details, refer to <i>Exception Code</i> on page 7-7 under <i>7-2-3 Response Format for Error Completion</i> on page 7-7.

● Execution Examples

Execution When S2 Is Set as the Gen2 Session for the Reader/Writer

TX: 000000000006FF03C3000001

RX: 000000000005FF03020002

SET ACCESS PASSWORD

● Function

This command sets the access password for RF Tag communications of the Reader/Writer.

● Command Format

Byte-0	Byte-1	Byte-2	Byte-3	Byte-4	Byte-5	Byte-6	Byte-7	Byte-8	Byte-9	Byte-10	Byte-11
Transaction identifier		Protocol identifier		Field length		Unit identifier	Function code	Register address		Word count	
X	X	0000 hex		000B hex		FF hex	10 hex	C400 hex		0002 hex	

Byte-12	Byte-13	...	Byte-16
Byte count	Access password		
04 hex	4 bytes		

Parameter	Description	Default setting
Register address	The register address (C400 hex) that specifies the access password setting	
Access password	Specify the access password to use for RF Tag communications in 8-digit hexadecimal. The specified access password is stored in EEPROM memory in the Reader/Writer. If the access password in the RF Tag is not all zeros, the access password that is stored in EEPROM memory must be used to execute LOCK, ID WRITE, DATA READ, or DATA WRITE commands.	00000000 hex

● Response Formats

• Normal Response

Byte-0	Byte-1	Byte-2	Byte-3	Byte-4	Byte-5	Byte-6	Byte-7	Byte-8	Byte-9	Byte-10	Byte-11
Transaction identifier		Protocol identifier		Field length		Unit identifier	Function code	Register address		Word count	
X	X	0000 hex		0006 hex		FF hex	10 hex	C400 hex		0002 hex	

Parameter	Description
Word count	Always 0002 hex.

• Error Response

Byte-0	Byte-1	Byte-2	Byte-3	Byte-4	Byte-5	Byte-6	Byte-7	Byte-8
Transaction identifier		Protocol identifier		Field length		Unit identifier	Function code	Exception code
X	X	0000 hex		0003 hex		FF hex	90 hex	1 byte

Parameter	Description
Exception code	For details, refer to <i>Exception Code</i> on page 7-7 under <i>7-2-3 Response Format for Error Completion</i> on page 7-7.

- **Execution Examples**

Execution to Set the Reader/Writer Access Password to “12345678 hex”

TX: 0000000000BFF10C40000020412345678

RX: 00000000006FF10C4000002

GET ACCESS PASSWORD

● Function

This command reads the access password that is set for RF Tag communications in the Reader/Writer.

● Command Format

Byte-0	Byte-1	Byte-2	Byte-3	Byte-4	Byte-5	Byte-6	Byte-7	Byte-8	Byte-9	Byte-10	Byte-11
Transaction identifier		Protocol identifier		Field length		Unit identifier	Function code	Register address		Word count	
X	X	0000 hex		0006 hex		FF hex	03 hex	C400 hex		0002 hex	

Parameter	Description
Register address	The register address (C400 hex) that specifies reading the access password
Word count	The number of words in the access password to read (0002 hex)

● Response Formats

• Normal Response

Byte-0	Byte-1	Byte-2	Byte-3	Byte-4	Byte-5	Byte-6	Byte-7	Byte-8	Byte-9	...	Byte-12
Transaction identifier		Protocol identifier		Field length		Unit identifier	Function code	Byte count	Access password		
X	X	0000 hex		0007 hex		FF hex	03 hex	04 hex	4 bytes		

Parameter	Description	Default setting
Byte count	The number of bytes in the access password (04 hex)	
Access password	Gives the access password to use for RF Tag communications in 8-digit hexadecimal. The specified access password is stored in EEPROM memory in the Reader/Writer. If the access password in the RF Tag is not all zeros, the access password that is stored in EEPROM memory must be used to execute LOCK, ID WRITE, DATA READ, or DATA WRITE commands.	00000000 hex

• Error Response

Byte-0	Byte-1	Byte-2	Byte-3	Byte-4	Byte-5	Byte-6	Byte-7	Byte-8
Transaction identifier		Protocol identifier		Field length		Unit identifier	Function code	Exception code
X	X	0000 hex		0003 hex		FF hex	83 hex	1 byte

Parameter	Description
Exception code	For details, refer to <i>Exception Code</i> on page 7-7 under <i>7-2-3 Response Format for Error Completion</i> on page 7-7.

● Execution Examples

Execution When the Reader/Writer Access Password Is Set to "12345678 hex"

TX: 000000000006FF03C4000002

RX: 000000000007FF030412345678

SET RF TAG SELECTION FILTER CONDITIONS

● Function

This command sets the RF Tag selection filter conditions for the Reader/Writer.

● Command Format

Byte-0	Byte-1	Byte-2	Byte-3	Byte-4	Byte-5	Byte-6	Byte-7	Byte-8	Byte-9	Byte-10	Byte-11
Transaction identifier		Protocol identifier		Field length		Unit identifier	Function code	Register address		Word count	
X	X	0000 hex		002D hex		FF hex	10 hex	C500 hex		0013 hex	

Byte-12	Byte-13	Byte-14	Byte-15	Byte-16	Byte-17	Byte-18	Byte-19	...	Byte-50
RF Tag selection filter conditions									
Byte count	Enable/disable		Address		Data length		Data		
26 hex	2 bytes		2 bytes		2 bytes		32 bytes		

Parameter	Description	Default setting	
Register address	The register address (C500 hex) that specifies setting the RF Tag selection filter conditions		
Word count	The number of words in the RF Tag selection filter conditions (0013 hex)		
Byte count	The number of bytes in the RF Tag selection filter conditions (26 hex)		
RF Tag selection filter conditions	Enable/disable	Specify whether to enable or disable RF Tag selection filter conditions in 4-digit hexadecimal. 0000 hex: Disable 0001 hex: Enable	0000 hex
	Address* ¹ .	Set the address (in words) of the RF Tag to check for in 4-digit hexadecimal. Setting ranges (word address specifications) 1000 to 17FF hex: UII (EPC) area 2000 to 27FF hex: TID area 3000 to 37FF hex: User area *You cannot specify 0000 to 07FF hex (reserved area).	0000 hex
	Data length* ¹ .	Specify the number of words of data to check in 4-digit hexadecimal. Setting range: 0000 to 0010 hex	0000 hex
	Data* ¹ .	Specify the data to check for. (Always 16 words.) *Fill unused data with 0000 hex. *In compliance with Gen2 standards, bits 0 to 255 are masked, so the last bit of word 16 (bit 256) is ignored.	00....00 hex

*1. If the RF Tag selection filter conditions settings are disabled, this value is always 0000 hex.

● Response Formats

- Normal Response

Byte-0	Byte-1	Byte-2	Byte-3	Byte-4	Byte-5	Byte-6	Byte-7	Byte-8	Byte-9	Byte-10	Byte-11
Transaction identifier		Protocol identifier		Field length		Unit identifier	Function code	Register address		Word count	
X	X	0000 hex		0006 hex		FF hex	10 hex	C500 hex		0013 hex	

Parameter	Description
Register address	The register address from the command is set.
Word count	The word count from the command is set.

• Error Response

Byte-0	Byte-1	Byte-2	Byte-3	Byte-4	Byte-5	Byte-6	Byte-7	Byte-8
Transaction identifier		Protocol identifier		Field length		Unit identifier	Function code	Exception code
X	X	0000 hex		0003 hex		FF hex	90 hex	1 byte

Parameter	Description
Exception code	For details, refer to <i>Exception Code</i> on page 7-7 under <i>7-2-3 Response Format for Error Completion</i> on page 7-7.

● Execution Examples

Example 1) When communicating with a tag where the lead word of the RF Tag Ull (EPC code) is 1234 hex using the RF Tag selection filter conditions of the Reader/Writer

Address: 1002 hex, Data length: 1 word, Data to check for: 1234 hex

TX: 00000000002DFF10C500001326000110020001123400...00

RX: 000000000006FF10C5000013

Example 2) Execution When Disabling RF Tag Selection Filter Conditions for the Reader/Writer

TX: 00000000002DFF10C5000013260000000000000000...00

RX: 000000000006FF10C5000013

GET RF TAG SELECTION FILTER CONDITIONS

● Function

This command reads the RF Tag selection filter conditions that are set in the Reader/Writer.

● Command Format

Byte-0	Byte-1	Byte-2	Byte-3	Byte-4	Byte-5	Byte-6	Byte-7	Byte-8	Byte-9	Byte-10	Byte-11
Transaction identifier		Protocol identifier		Field length		Unit identifier	Function code	Register address		Word count	
X	X	0000 hex		0006 hex		FF hex	03 hex	C500 hex		0013 hex	

Parameter	Description
Register address	The register address (C500 hex) that specifies setting the RF Tag selection filter conditions
Word count	The number of words in the RF Tag selection filter conditions to read (0013 hex)

● Response Formats

- Normal Response

Byte-0	Byte-1	Byte-2	Byte-3	Byte-4	Byte-5	Byte-6	Byte-7	Byte-8
Transaction identifier		Protocol identifier		Field length		Unit identifier	Function code	Byte count
X	X	0000 hex		0028 hex		FF hex	03 hex	26 hex

Byte-9	Byte-10	Byte-11	Byte-12	Byte-13	Byte-14	Byte-15	...	Byte-46
RF Tag selection filter conditions								
Enable/disable		Address		Data length		Data		
2 bytes		2 bytes		2 bytes		32 bytes		

Parameter	Description	Default setting	
Byte count	The number of bytes in the RF Tag selection filter conditions (26 hex)		
RF Tag selection filter conditions	Enable/disable	Gives whether RF Tag selection filter conditions are enabled or disabled in 4-digit hexadecimal. 0000 hex: Disable 0001 hex: Enable	0000 hex
	Address ^{*1.}	Gives the address (in words) of the RF Tag to check for in 4-digit hexadecimal. 1000 to 17FF hex: Ull (EPC) area 2000 to 27FF hex: TID area 3000 to 37FF hex: User area	0000 hex
	Data length ^{*1.}	Gives the number of words of data to check in 4-digit hexadecimal. 0000 to 0010 hex	0000 hex
	Data ^{*1.}	Gives the data to check for. (Always 16 words.) ^{*1.} Unused data is filled with 0000 hex. ^{*1.} In compliance with Gen2 standards, bits 0 to 255 are masked, so the last bit of word 16 (bit 256) is ignored.	00....00 hex

*1. If the RF Tag selection filter conditions settings are being disabled, this value is always 0000 hex.

- Error Response

Byte-0	Byte-1	Byte-2	Byte-3	Byte-4	Byte-5	Byte-6	Byte-7	Byte-8
Transaction identifier		Protocol identifier		Field length		Unit identifier	Function code	Exception code
X	X	0000 hex		0003 hex		FF hex	83 hex	1 byte

Parameter	Description
Exception code	For details, refer to <i>Exception Code</i> on page 7-7 under <i>7-2-3 Response Format for Error Completion</i> on page 7-7.

- Execution Examples

Execution When RF Tag Selection Filter Conditions for the Reader/Writer Are Enabled with the Following Settings

Address: 3000 hex, Data length: 1 word, Data to check: 1234 hex

TX: 000000000006FF03C5000013

RX: 00000000029FF0326000130000001123400...00

SET RSSI FILTER CONDITIONS

● Function

This command sets the RSSI filter conditions for the Reader/Writer.

● Command Format

Byte-0	Byte-1	Byte-2	Byte-3	Byte-4	Byte-5	Byte-6	Byte-7	Byte-8	Byte-9	Byte-10	Byte-11
Transaction identifier		Protocol identifier		Field length		Unit identifier	Function code	Register address		Word count	
X	X	0000 hex		000D hex		FF hex	10 hex	C600 hex		0003 hex	

Byte-12	Byte-13	Byte-14	Byte-15	Byte-16	Byte-17	Byte-18
Byte count	RSSI filter conditions					
	Enable/disable		High threshold		Low threshold	
06 hex	2 bytes		2 bytes		2 bytes	

Parameter	Description	Default setting	
Register address	The register address (C600 hex) that specifies the RSSI filter conditions		
Word count	The number of words in the RSSI filter conditions (0003 hex)		
Byte count	The number of bytes in the RSSI filter conditions (06 hex)		
RSSI filter conditions	Enable/disable	Specify whether the RSSI filter is enabled or disabled in 4-digits hexadecimal. 0000 hex: Disable 0001 hex: Enable	0000 hex
	High threshold ^{*1}	Specify the high threshold for the reception level in signed 4-digit hexadecimal. FFF6 to FFBA hex (0 or -70 to -10) [dBm]	0000 hex
	Low threshold ^{*1}	Specify the low threshold for the reception level in signed 4-digit hexadecimal. FFF6 to FFBA hex (0 or -70 to -10) [dBm]	0000 hex

*1. When you disable the RSSI filter conditions, set the high and low thresholds to 0000 hex. When you enable the RSSI filter, set the high threshold value for the RSSI filter condition to a higher value than the low threshold level. Otherwise, a command parameter error will occur.

● Response Formats

• Normal Response

Byte-0	Byte-1	Byte-2	Byte-3	Byte-4	Byte-5	Byte-6	Byte-7	Byte-8	Byte-9	Byte-10	Byte-11
Transaction identifier		Protocol identifier		Field length		Unit identifier	Function code	Register address		Word count	
X	X	0000 hex		0006 hex		FF hex	10 hex	C600 hex		0003 hex	

Parameter	Description
Register address	The register address from the command is set.
Word count	The word count from the command is set.

• Error Response

Byte-0	Byte-1	Byte-2	Byte-3	Byte-4	Byte-5	Byte-6	Byte-7	Byte-8
Transaction identifier		Protocol identifier		Field length		Unit identifier	Function code	Exception code
X	X	0000 hex		0003 hex		FF hex	90 hex	1 byte

Parameter	Description
Exception code	For details, refer to <i>Exception Code</i> on page 7-7 under <i>Response Format for Error Completion</i> on page 7-7.

● Execution Examples

Example 1) Execution When Enabling RSSI Filter Conditions for the Reader/Writer with the Following Settings

High threshold: -40 dBm (FFD8 hex), Low threshold: -64 dBm (FFC0 hex)

TX: 00000000000DFF10C6000003060001FFD8FFC0

RX: 000000000006FF10C6000003

Example 2) Execution When Disabling RSSI Filter Conditions for the Reader/Writer

TX: 00000000000DFF10C60000030600000000000

RX: 000000000006FF10C6000003

GET RSSI FILTER CONDITIONS

● Function

This command is used to check the RSSI filter conditions that are set in the Reader/Writer.

● Command Format

Byte-0	Byte-1	Byte-2	Byte-3	Byte-4	Byte-5	Byte-6	Byte-7	Byte-8	Byte-9	Byte-10	Byte-11
Transaction identifier		Protocol identifier		Field length		Unit identifier	Function code	Register address		Word count	
X	X	0000 hex		0006 hex		FF hex	03 hex	C600 hex		0003 hex	

Parameter	Description
Register address	The register address (C600 hex) that specifies reading the RSSI filter conditions
Word count	The number of words in the RSSI filter conditions to read (0003 hex)

● Response Formats

• Normal Response

Byte-0	Byte-1	Byte-2	Byte-3	Byte-4	Byte-5	Byte-6	Byte-7	Byte-8
Transaction identifier		Protocol identifier		Field length		Unit identifier	Function code	Byte count
X	X	0000 hex		0009 hex		FF hex	03 hex	04 hex

Byte-9	Byte-10	Byte-11	Byte-12	Byte-13	Byte-14
RSSI filter conditions					
Enable/disable		High threshold		Low threshold	
2 bytes		2 bytes		2 bytes	

Parameter	Description	Default setting	
Byte count	The number of bytes in the RSSI filter conditions (06 hex)		
RSSI filter conditions	Enable/disable	Gives whether the RSSI filter is enabled or disabled in 4-digits hexadecimal. 0000 hex: Disable 0001 hex: Enable	0000 hex
	High threshold *1	Gives the RSSI high threshold level in signed 4-digit hexadecimal. FFF6 to FFBA hex (0 or -70 to -10) [dBm]	0000 hex
	Low threshold *1	Gives the RSSI low threshold level in signed 4-digit hexadecimal. FFF6 to FFBA hex (0 or -70 to -10) [dBm]	0000 hex

*1. If the RSSI filter conditions are disabled, the high and low threshold levels will always be 0000 hex.

• Error Response

Byte-0	Byte-1	Byte-2	Byte-3	Byte-4	Byte-5	Byte-6	Byte-7	Byte-8
Transaction identifier		Protocol identifier		Field length		Unit identifier	Function code	Exception code
X	X	0000 hex		0003 hex		FF hex	83 hex	1 byte

Parameter	Description
Exception code	For details, refer to <i>Exception Code</i> on page 7-7 under <i>7-2-3 Response Format for Error Completion</i> on page 7-7.

● Execution Examples

Execution When RSSI Filter Conditions for the Reader/Writer Are Enabled with the Following Settings

High threshold: -40 dBm (FFD8 hex), Low threshold: -64 dBm (FFC0 hex)

TX: 000000000006FF03C6000003

RX: 000000000009FF03060001FFD8FFC0

SET TRANSMISSION TIME

● Function

This command sets the time to stop the transmission power.

● Command Format

Byte-0	Byte-1	Byte-2	Byte-3	Byte-4	Byte-5	Byte-6	Byte-7	Byte-8	Byte-9	Byte-10	Byte-11
Transaction identifier		Protocol identifier		Field length		Unit identifier	Function code	Register address		Word count	
X	X	0000 hex		000B hex		FF hex	10 hex	C700 hex		0002 hex	

Byte-12	Byte-13	Byte-14	Byte-15	Byte-16
Byte count	Stop time		Reserved	
04 hex	2 bytes		Always 0000 hex.	

Parameter	Description	Default setting
Register address	The register address (C700 hex) that specifies setting the transmission times	
Word count	The number of words in the transmission time setting (0002 hex)	
Byte count	The number of bytes in the transmission time setting (04 hex)	
Stop time*1.	Gives the maximum time to continuously output radio waves during the execution of the communications command in 4-digit hexadecimal.	
V780-HMD68-E TN-JP	0000 hex, 000A hex to 03E8 hex (0000 hex is ignored, or 10 to 1,000) [ms]	0000 hex
V780-HMD-ETN -KR/-TW/-ID/-M Y/-SG/-MX	000A to 03E8 hex (10 to 1,000) [ms]	000A hex
V780-HMD68-E TN-CN	000A to 03E8 hex (10 to 1,000) [ms]	000A hex
V780-HMD68-E TN-IN/-EU/-RU	0064 to 03E8 hex (100 to 1,000) [ms]	0064 hex
Continuous transmission time	Gives the maximum time to continuously output radio waves during the execution of the communications command in 4-digit hexadecimal.	
V780-HMD68-E TN-JP*1	0000 hex, 000A hex to 03E8 hex (0000 hex is ignored, or 10 to 1,000) [ms]	0000 hex
Models other than V780-HMD68-E TN-JP	Always 0000 hex.	---

*1. The stop time cannot be set to 0000 hex in models other than V780-HMD68-ETN-JP. The default is 0010 hex.

● Response Formats

• Normal Response

Byte-0	Byte-1	Byte-2	Byte-3	Byte-4	Byte-5	Byte-6	Byte-7	Byte-8	Byte-9	Byte-10	Byte-11
Transaction identifier		Protocol identifier		Field length		Unit identifier	Function code	Register address		Word count	
X	X	0000 hex		0006 hex		FF hex	10 hex	C700 hex		0002 hex	

Parameter	Description
Register address	The register address from the command is set.
Word count	The word count from the command is set.

• Error Response

Byte-0	Byte-1	Byte-2	Byte-3	Byte-4	Byte-5	Byte-6	Byte-7	Byte-8
Transaction identifier		Protocol identifier		Field length		Unit identifier	Function code	Exception code
X	X	0000 hex		0003 hex		FF hex	90 hex	1 byte

Parameter	Description
Exception code	For details, refer to <i>Exception Code</i> on page 7-7 under 7-2-3 <i>Response Format for Error Completion</i> on page 7-7.

● Execution Examples

Example 1: Execution to Set the Following Times in the Reader/Writer

<Stop time: 10 ms (000A hex), Continuous transmission time: 400 ms (0190 hex)>

TX: 000000000000BFF10C700000204000A0190

RX: 0000000000006FF10C7000002

Example 2: Execution to Set the Following Times in the Reader/Writer

<Stop time: None, Continuous transmission time: Infinite>

TX: 000000000000BFF10C70000020400000000

RX: 0000000000006FF10C7000002

GET TRANSMISSION TIME

● Function

This command is used to check the transmission times that are set in the Reader/Writer.

● Command Format

Byte-0	Byte-1	Byte-2	Byte-3	Byte-4	Byte-5	Byte-6	Byte-7	Byte-8	Byte-9	Byte-10	Byte-11
Transaction identifier		Protocol identifier		Field length		Unit identifier	Function code	Register address		Word count	
X	X	0000 hex		0006 hex		FF hex	03 hex	C700 hex		0002 hex	

Parameter	Description
Register address	The register address (C700 hex) that specifies reading the transmission time settings
Word count	Always 0002 hex.

● Response Formats

- Normal Response

Byte-0	Byte-1	Byte-2	Byte-3	Byte-4	Byte-5	Byte-6	Byte-7	Byte-8
Transaction identifier		Protocol identifier		Field length		Unit identifier	Function code	Byte count
X	X	0000 hex		0007 hex		FF hex	03 hex	04 hex

Byte-9	Byte-10	Byte-11	Byte-12
Stop time		Reserved	
2 bytes		Always 0000 hex.	

Parameter	Description	Default setting
Field length	Always 0007 hex.	
Byte count	The number of bytes in the transmission times to read (04 hex)	
Stop time* ¹ .	Gives the time that is set to stop the output during RF communications command execution in 4-digit hexadecimal.	
V780-HMD68-E TN-JP	0000 hex, 000A hex to 03E8 hex (0000 hex is ignored, or 10 to 1,000) [ms]	0000 hex
V780-HMD68-E TN-KR/-SG/-TW /-US/-MX	000A hex to 03E8 hex (10 to 1,000) [ms]	000A hex
V780-HMD68-E TN-CN	000A hex to 03E8 hex (10 to 1,000) [ms]	000A hex
V780-HMD68-E TN-IN/-EU/-RU	0064 hex to 03E8 hex (100 to 1,000) [ms]	0064 hex
Continuous transmission time	Gives the maximum time to continuously output radio waves during the execution of the communications command in 4-digit hexadecimal.	
V780-HMD68-E TN-JP	0000 hex, 0190 hex to 2710 hex (0000 hex is infinite, or 400 to 10,000) [ms]	0000 hex
Models other than V780-HMD68-E TN-JP	Always 0000 hex.	---

- Error Response

Byte-0	Byte-1	Byte-2	Byte-3	Byte-4	Byte-5	Byte-6	Byte-7	Byte-8
Transaction identifier		Protocol identifier		Field length		Unit identifier	Function code	Exception code
X	X	0000 hex		0003 hex		FF hex	83 hex	1 byte

Parameter	Description
Exception code	For details, refer to <i>Exception Code</i> on page 7-7 under <i>7-2-3 Response Format for Error Completion</i> on page 7-7.

- **Execution Examples**

Execution When the Following RF Transmission Times Are Set in the Reader/Writer

Stop time: 10 ms (000A hex)

TX: 000000000006FF03C7000002

RX: 000000000007FF0304000A0000

7-6-7 Reader/Writer Setting Commands: Device Settings

SET OPERATION INDICATOR CUSTOM CONDITIONS

● Function

This command sets the colors of the NORM/ERR indicators during command execution.

● Command Format

Byte-0	Byte-1	Byte-2	Byte-3	Byte-4	Byte-5	Byte-6	Byte-7	Byte-8	Byte-9	Byte-10	Byte-11
Transaction identifier		Protocol identifier		Field length		Unit identifier	Function code	Register address		Word count	
X	X	0000 hex		000D hex		FF hex	10 hex	B800 hex		0003 hex	

Byte-12	Byte-13	Byte-14	Byte-15	Byte-16	Byte-17	Byte-18
Byte count	Color to flash once for normal command execution		Color to flash once for command error		Color to flash once for unstable communications	
06 hex	2 bytes		2 bytes		2 bytes	

Parameter	Description	
Register address	The register address (B800 hex) that specifies setting operation indicator custom conditions	
Word count	The number of words in the operation indicator custom condition settings (0003 hex)	
Byte count	The number of bytes in the operation indicator custom condition settings (06 hex)	
Color to flash once for normal command execution	Specify the color to flash once when V780 command processing ends normally in 4-digit hexadecimal. 0000 hex: Default 0001 hex: Green 0002 hex: Red 0003 hex: Yellow 0004 hex: Blue 0005 hex: Cyan 0006 hex: Magenta 0007 hex: White FFFF hex: Do not flash.* ¹	0000 hex
Color to flash once for command error	Specify the color to flash once when V780 command processing ends in an error in 4-digit hexadecimal. *The color settings are they same as for flashing once for normal command completion, given above.	0002 hex
Color to flash once for unstable communications	Specify the color to flash once when the results of executing communications diagnostics indicates that communications are unstable in 4-digit hexadecimal. *The colors settings are they same as for flashing once for normal command completion, given above.	0003 hex

*1. To prevent the NORM/ERR indicators from lighting at all during command execution, set all of the lighting conditions to "Do not flash." You cannot prevent them from lighting by setting only individual conditions.



Precautions for Correct Use

If you set all of the conditions to “Do not flash,” the NORM/ERR indicators will not light at all even during operation in Focus Mode.

● **Response Formats**

- Normal Response

Byte-0	Byte-1	Byte-2	Byte-3	Byte-4	Byte-5	Byte-6	Byte-7	Byte-8	Byte-9	Byte-10	Byte-11
Transaction identifier		Protocol identifier		Field length		Unit identifier	Function code	Register address		Word count	
X	X	0000 hex		0006 hex		FF hex	10 hex	B800 hex		0003 hex	

Parameter	Description
Register address	The register address from the command is set.
Word count	The word count from the command is set.

- Error Response

Byte-0	Byte-1	Byte-2	Byte-3	Byte-4	Byte-5	Byte-6	Byte-7	Byte-8
Transaction identifier		Protocol identifier		Field length		Unit identifier	Function code	Exception code
X	X	0000 hex		0003 hex		FF hex	90 hex	1 byte

Parameter	Description
Exception code	For details, refer to <i>Exception Code</i> on page 7-7 under <i>7-2-3 Response Format for Error Completion</i> on page 7-7.

● **Execution Examples**

Execution to Set Operation Indicator Custom Conditions for the Reader/Writer

Example 1: Execution to Change to the Following Colors for the NORM/ERR Indicators during Command Execution

Normal completion: Cyan, Error completion: Magenta, Unstable communications: White

TX: 0000000000DFF10B800000306000500060007

RX: 000000000006FF10B8000003

Example 2: Execution to Change the NORM/ERR Indicators to Not Light at All during Command Execution

TX: 0000000000DFF10B800000306FFFFFFFFFFFFFF

RX: 000000000006FF10B8000003

GET OPERATION INDICATOR CUSTOM CONDITIONS

● Function

This command is used to check the NORM/ERR indicator lighting colors for communications results that are set in the Reader/Writer.

● Command Format

Byte-0	Byte-1	Byte-2	Byte-3	Byte-4	Byte-5	Byte-6	Byte-7	Byte-8	Byte-9	Byte-10	Byte-11
Transaction identifier		Protocol identifier		Field length		Unit identifier	Function code	Register address		Word count	
X	X	0000 hex		0006 hex		FF hex	03 hex	B800 hex		0003 hex	

Parameter	Description	Default setting
Register address	The register address (B800 hex) that specifies the operation indicator custom settings	
Word count	The number of words in the operation indicator custom conditions to read (0003 hex)	

● Response Formats

- Normal Response

Byte-0	Byte-1	Byte-2	Byte-3	Byte-4	Byte-5	Byte-6	Byte-7	Byte-8
Transaction identifier		Protocol identifier		Field length		Unit identifier	Function code	Byte count
X	X	0000 hex		0009 hex		FF hex	03 hex	06 hex

Byte-9	Byte-10	Byte-11	Byte-12	Byte-13	Byte-14
Color to flash once for normal command execution		Color to flash once for command error		Color to flash once for unstable communications	
2 bytes		2 bytes		2 bytes	

Parameter	Description	
Byte count	The number of bytes in the operation indicator custom settings (06 hex)	
Color to flash once for normal command execution	Gives the color to flash once when V780 command processing ends normally in 4-digit hexadecimal. 0001 hex: Green 0002 hex: Red 0003 hex: Yellow 0004 hex: Blue 0004 hex: Blue 0006 hex: Magenta 0007 hex: White FFFF hex: Do not flash.	0001 hex
Color to flash once for command error	Gives the color to flash once when V780 command processing ends in an error in 4-digit hexadecimal. *The colors settings are they same as for flashing once for normal command completion, given above.	0002 hex
Color to flash once for unstable communications	Gives the color to flash once when the results of executing communications diagnostics indicates that communications are unstable in 4-digit hexadecimal. *The colors settings are they same as for flashing once for normal command completion, given above.	0003 hex

- Error Response

Byte-0	Byte-1	Byte-2	Byte-3	Byte-4	Byte-5	Byte-6	Byte-7	Byte-8
Transaction identifier		Protocol identifier		Field length		Unit identifier	Function code	Exception code
X	X	0000 hex		0003 hex		FF hex	83 hex	1 byte

Parameter	Description
Exception code	For details, refer to <i>Exception Code</i> on page 7-7 under <i>7-2-3 Response Format for Error Completion</i> on page 7-7.

- Execution Examples

Execution When the Following NORM/ERR Indicator Lighting Colors Are Set for Command Execution by the Reader/Writer

Normal completion: Green, Error completion: Red, Unstable communications: Yellow

TX: 000000000006FF03B8000003

RX: 000000000009FF0306000100020003

SET MULTI-READER/WRITER CONFIGURATION

● Function

This sets the Multi-Reader/Writer configuration.
These setting are enabled after the next startup.

● Command Format

Byte-0	Byte-1	Byte-2	Byte-3	Byte-4	Byte-5	Byte-6	Byte-7	Byte-8	Byte-9	Byte-10	Byte-11	Byte-12
Transaction identifier		Protocol identifier		Field length		Unit identifier	Function code	Register address		Word count		Byte count
X	X	0000 hex		0027 hex		FF hex	10 hex	B900 hex		0010 hex		20 hex

Byte-13	Byte-14	Byte-15	Byte-16	Byte-17	...	Byte-20	Byte-21	...	Byte-24	...	Byte-41	...	Byte-44
Multi-Reader/Writer Configuration Setting Information													
Multi-Reader/Writer Mode		Number of Slave Reader/Writers		IP address									
				Slave Reader/Writer 1		Slave Reader/Writer 2		...		Slave Reader/Writer 7			
2 bytes		2 bytes		4 bytes		4 bytes		...		4 bytes			

Parameter	Description		Default setting	
Register address	Register number (B900 hex) indicating the Multi-Reader/Writer configuration setting			
Word count	Number of words (0010 hex) of the Multi-Reader/Writer Configuration Setting			
Byte count	Number of bytes (20 hex) of the Multi-Reader/Writer Configuration Setting			
Multi-Reader/Writer Configuration Setting Information	Multi-Reader/Writer Mode		0000 hex	
	Number of Slave Reader/Writers		0000 hex	
	IP address	Slave Reader/Writer 1	This specifies the IP address of slave Reader/Writer 1 in 8 hexadecimal digits. Setting range: 00000000 hex to DFFFFFFF hex Example) C0A801C9 hex (192.168.1.201)	00000000 hex
		Slave Reader/Writer 2	This specifies the IP address of slave Reader/Writer 2 in 8 hexadecimal digits. Setting range: 00000000 hex to DFFFFFFF hex Example) C0A801CA hex (192.168.1.202)	00000000 hex
	⋮		⋮	⋮
		Slave Reader/Writer 6	This specifies the IP address of slave Reader/Writer 6 in 8 hexadecimal digits. Setting range: 00000000 hex to DFFFFFFF hex Example) C0A801CE hex (192.168.1.206)	00000000 hex
	Slave Reader/Writer 7	This specifies the IP address of slave Reader/Writer 7 in 8 hexadecimal digits. Setting range: 00000000 hex to DFFFFFFF hex Example) C0A801CF hex (192.168.1.207)	00000000 hex	

● **Response Formats**

- Normal Response

Byte-0	Byte-1	Byte-2	Byte-3	Byte-4	Byte-5	Byte-6	Byte-7	Byte-8	Byte-9	Byte-10	Byte-11
Transaction identifier		Protocol identifier		Field length		Unit identifier	Function code	Register address		Word count	
X	X	0000 hex		0006 hex		FF hex	10 hex	B900 hex		0010 hex	

Parameter	Description
Register address	The register address from the command is set.
Word count	The word count from the command is set.

- Error Response

Byte-0	Byte-1	Byte-2	Byte-3	Byte-4	Byte-5	Byte-6	Byte-7	Byte-8
Transaction identifier		Protocol identifier		Field length		Unit identifier	Function code	Exception code
X	X	0000 hex		0003 hex		FF hex	90 hex	1 byte

Parameter	Description
Exception code	For details, refer to <i>Exception Code</i> on page 7-7 under <i>7-2-3 Response Format for Error Completion</i> on page 7-7.

● **Execution Examples**

Execution to set the following in the Multi-Reader/Writer configuration

Setting item	Description	
Multi-Reader/Writer Mode	Enabled (Communications Range Extension Mode)	
Number of Slave Reader/Writers	3	
IP Address	Slave Reader/Writer 1	192.168.1.201
	Slave Reader/Writer 2	192.168.1.202
	Slave Reader/Writer 3	192.168.1.203

TX: 000000000023FF032000010003C0A801C9C0A801CAC0A801CB00000000000000
00000000000000000000

RX: 000000000006FF03B9000010

GET MULTI-READER/WRITER CONFIGURATION

● Function

This command is used to check the Multi-Reader/Writer configuration set in the Reader/Writer.

● Command Format

Byte-0	Byte-1	Byte-2	Byte-3	Byte-4	Byte-5	Byte-6	Byte-7	Byte-8	Byte-9	Byte-10	Byte-11
Transaction identifier		Protocol identifier		Field length		Unit identifier	Function code	Register address		Word count	
X	X	0000 hex		0006 hex		FF hex	03 hex	B900 hex		0010 hex	

Parameter	Description	Default setting
Register address	Register number (B900 hex) indicating the Multi-Reader/Writer configuration setting	
Word count	Number of words (0010 hex) of the Multi-Reader/Writer Configuration to be obtained	

● Response Formats

- Normal Response

Byte-0	Byte-1	Byte-2	Byte-3	Byte-4	Byte-5	Byte-6	Byte-7	Byte-8
Transaction identifier		Protocol identifier		Field length		Unit identifier	Function code	Byte count
X	X	0000 hex		0023 hex		FF hex	03 hex	20 hex

Byte-9	Byte-10	Byte-11	Byte-12	Byte-13	...	Byte-16	Byte-17	...	Byte-20	...	Byte-37	...	Byte-40
Multi-Reader/Writer Configuration Setting Information													
Multi-Reader/Writer Mode		Number of Slave Reader/Writers		IP address									
				Slave Reader/Writer 1		Slave Reader/Writer 2		...		Slave Reader/Writer 7			
2 bytes		2 bytes		4 bytes		4 bytes		...		4 bytes			

Parameter	Description	Default setting	
Byte count	The number of bytes in the Multi-Reader/Writer Configuration Settings that was read (10 hex)		
Multi-Reader/Writer Configuration Setting Information	Multi-Reader/Writer Mode	This specifies whether the Multi-Reader/Writer mode is enabled in 4 hexadecimal digits. 0000 hex: Disabled 0001 hex: Enabled (Communications Range Extension Mode)	0000 hex
	Number of Slave Reader/Writers	This specifies the number of slave Reader/Writers in 4 hexadecimal digits. 0000 hex to 0007 hex	0000 hex

Parameter	Description		Default setting	
Multi-Reader/Writer Configuration Setting Information	IP address	Slave Reader/Writer 1	This specifies the IP address of slave Reader/Writer 1 in 8 hexadecimal digits. Setting range: 00000000 hex to DFFFFFFF hex Example) C0A801C9 hex (192.168.1.201)	00000000 hex
		Slave Reader/Writer 2	This specifies the IP address of slave Reader/Writer 2 in 8 hexadecimal digits. Setting range: 00000000 hex to DFFFFFFF hex Example) C0A801CA hex (192.168.1.202)	00000000 hex
		⋮	⋮	⋮
		Slave Reader/Writer 6	This specifies the IP address of slave Reader/Writer 6 in 8 hexadecimal digits. Setting range: 00000000 hex to DFFFFFFF hex Example) C0A801CE hex (192.168.1.206)	00000000 hex
		Slave Reader/Writer 7	This specifies the IP address of slave Reader/Writer 7 in 8 hexadecimal digits. Setting range: 00000000 hex to DFFFFFFF hex Example) C0A801CF hex (192.168.1.207)	00000000 hex

• Error Response

Byte-0	Byte-1	Byte-2	Byte-3	Byte-4	Byte-5	Byte-6	Byte-7	Byte-8
Transaction identifier	Protocol identifier		Field length		Unit identifier	Function code	Exception code	
X	X	0000 hex		0003 hex		FF hex	83 hex 1 byte	

Parameter	Description
Exception code	For details, refer to <i>Exception Code</i> on page 7-7 under <i>7-2-3 Response Format for Error Completion</i> on page 7-7.

● Execution Examples

Execution to set the following in the Multi-Reader/Writer configuration

Setting item	Description	
Multi-Reader/Writer Mode	Enabled (Communications Range Extension Mode)	
Number of Slave Reader/Writers	3	
IP Address	Slave Reader/Writer 1	192.168.1.201
	Slave Reader/Writer 2	192.168.1.202
	Slave Reader/Writer 3	192.168.1.203

TX: 000000000006FF03B9000010

RX: 00000000023FF032000010003C0A801C9C0A801CAC0A801CB00000000000000
000000000000000000

7-6-8 Maintenance Commands: Device Information

GET MODEL INFORMATION

● Function

This command is used to check the model number of the Reader/Writer.

● Command Format

Byte-0	Byte-1	Byte-2	Byte-3	Byte-4	Byte-5	Byte-6	Byte-7	Byte-8	Byte-9	Byte-10	Byte-11
Transaction identifier		Protocol identifier		Field length		Unit identifier	Function code	Register address		Word count	
X	X	0000 hex		0006 hex		FF hex	03 hex	D000 hex		0010 hex	

Parameter	Description
Register address	The register address (D000 hex) that specifies the model number information
Word count	The number of words in the model number information to read (0010 hex)

● Response Formats

- Normal Response

Byte-0	Byte-1	Byte-2	Byte-3	Byte-4	Byte-5	Byte-6	Byte-7	Byte-8	Byte-9	...	Byte-40
Transaction identifier		Protocol identifier		Field length		Unit identifier	Function code	Byte count	Model information		
X	X	0000 hex		0023 hex		FF hex	03 hex	20 hex	32 bytes		

Parameter	Description
Byte count	The number of bytes in the model number information that was read (20 hex)
Model information	Gives the model information that was read with up to 32 bytes of ASCII characters (up to 31 ASCII characters plus the end code (00 hex)). If there are fewer than 31 characters, the remaining bytes are filled with 00 hex. The model number is given with ASCII characters 20 hex (space) to 7E hex (~).

- Error Response

Byte-0	Byte-1	Byte-2	Byte-3	Byte-4	Byte-5	Byte-6	Byte-7	Byte-8
Transaction identifier		Protocol identifier		Field length		Unit identifier	Function code	Exception code
X	X	0000 hex		0003 hex		FF hex	83 hex	1 byte

Parameter	Description
Exception code	For details, refer to <i>Exception Code</i> on page 7-7 under <i>7-2-3 Response Format for Error Completion</i> on page 7-7.

GET FIRMWARE VERSION

● Function

This command reads the firmware version of the Reader/Writer.

● Command Format

Byte-0	Byte-1	Byte-2	Byte-3	Byte-4	Byte-5	Byte-6	Byte-7	Byte-8	Byte-9	Byte-10	Byte-11
Transaction identifier		Protocol identifier		Field length		Unit identifier	Function code	Register address		Word count	
X	X	0000 hex		0006 hex		FF hex	03 hex	D100 hex		0006 hex	

Parameter	Description
Register address	The register address (D100 hex) that specifies the firmware version
Word count	The number of words in the firmware version information to read (0006 hex)

● Response Formats

• Normal Response

Byte-0	Byte-1	Byte-2	Byte-3	Byte-4	Byte-5	Byte-6	Byte-7	Byte-8
Transaction identifier		Protocol identifier		Field length		Unit identifier	Function code	Byte count
X	X	0000 hex		000F hex		FF hex	03 hex	0C hex

Byte-9	Byte-10	Byte-11	Byte-12	Byte-13	Byte-14	Byte-15	Byte-16	Byte-17	Byte-18	Byte-19	Byte-20
Firmware version											
Major version of Run Mode program		Minor version of Run Mode program		Run Mode program revision		Major version of Safe Mode program		Minor version of Safe Mode program		Safe Mode program revision	
2 bytes		2 bytes		2 bytes		2 bytes		2 bytes		2 bytes	

Parameter	Description	
Byte count	The number of bytes in the firmware version information (0C hex)	
Firmware version	Major version of Run Mode program	0000 to 0099 hex (BCD)
	Minor version of Run Mode program	0000 to 0099 hex (BCD)
	Run Mode program revision	0000 to 9999 hex (BCD)
	Major version of Safe Mode program	0000 to 0099 hex (BCD)
	Minor version of Safe Mode program	0000 to 0099 hex (BCD)
	Safe Mode program revision	0000 to 9999 hex (BCD)

• Error Response

Byte-0	Byte-1	Byte-2	Byte-3	Byte-4	Byte-5	Byte-6	Byte-7	Byte-8
Transaction identifier		Protocol identifier		Field length		Unit identifier	Function code	Exception code
X	X	0000 hex		0003 hex		FF hex	83 hex	1 byte

Parameter	Description
Exception code	For details, refer to <i>Exception Code</i> on page 7-7 under <i>7-2-3 Response Format for Error Completion</i> on page 7-7.

● Execution Examples

Execution with the Following Firmware Versions in the Reader/Writer

Run Mode program version: 1.2.3, Safe Mode program version: 1.2.2

TX: 000000000006FF03D1000006

RX: 00000000000FFF030C000100020003000100020002

GET MAC ADDRESS

● Function

This command is used to check the MAC address from the Reader/Writer.

● Command Format

Byte-0	Byte-1	Byte-2	Byte-3	Byte-4	Byte-5	Byte-6	Byte-7	Byte-8	Byte-9	Byte-10	Byte-11
Transaction identifier		Protocol identifier		Field length		Unit identifier	Function code	Register address		Word count	
X	X	0000 hex		0006 hex		FF hex	03 hex	D200 hex		0003 hex	

Parameter	Description
Register address	The register address (D200 hex) that specifies the MAC address
Word count	The number of words in the MAC address to read (0003 hex)

● Response Formats

• Normal Response

Byte-0	Byte-1	Byte-2	Byte-3	Byte-4	Byte-5	Byte-6	Byte-7	Byte-8	Byte-9	...	Byte-14
Transaction identifier		Protocol identifier		Field length		Unit identifier	Function code	Byte count	MAC address		
X	X	0000 hex		0009 hex		FF hex	03 hex	06 hex	6 bytes		

Parameter	Description
Byte count	The number of bytes in the MAC address that was read (06 hex)
MAC address	Gives the MAC address that was read as a 12-digit hexadecimal between 000000000000 and FFFFFFFF hex.

• Error Response

Byte-0	Byte-1	Byte-2	Byte-3	Byte-4	Byte-5	Byte-6	Byte-7	Byte-8
Transaction identifier		Protocol identifier		Field length		Unit identifier	Function code	Exception code
X	X	0000 hex		0003 hex		FF hex	83 hex	1 byte

Parameter	Description
Exception code	For details, refer to <i>Exception Code</i> on page 7-7 under <i>7-2-3 Response Format for Error Completion</i> on page 7-7.

● Execution Examples

Execution to Read a MAC Address of "11-22-33-44-55-66" from the Reader/Writer

TX: 000000000006FF03D2000003

RX: 000000000009FF0306112233445566

GET OPERATING STATUS

● Function

This command is used to check the operating status from the Reader/Writer.

● Command Format

Byte-0	Byte-1	Byte-2	Byte-3	Byte-4	Byte-5	Byte-6	Byte-7	Byte-8	Byte-9	Byte-10	Byte-11
Transaction identifier		Protocol identifier		Field length		Unit identifier	Function code	Register address		Word count	
X	X	0000 hex		0006 hex		FF hex	03 hex	D300 hex		0002 hex	

Parameter	Description
Register address	The register address (D300 hex) that specifies the operating status
Word count	The number of words in the Reader/Writer operating status to read (0002 hex)

● Response Formats

• Normal Response

Byte-0	Byte-1	Byte-2	Byte-3	Byte-4	Byte-5	Byte-6	Byte-7	Byte-8
Transaction identifier		Protocol identifier		Field length		Unit identifier	Function code	Byte count
X	X	0000 hex		0007 hex		FF hex	03 hex	04 hex

Byte-9	Byte-10	Byte-11	Byte-12
Reader/Writer operating status			
Mode		Status	
2 bytes		2 bytes	

Parameter	Description	
Byte count	The number of bytes in the Reader/Writer operating status that was read (0C hex)	
Reader/Writer operating status	Mode	Gives the mode of the Reader/Writer that was read in 4-digits hexadecimal. 0000 hex: Safe Mode 0001 hex: Run Mode
	Status	Gives the status of the Reader/Writer that was read in 4-digits hexadecimal. 0001 hex: Idling 0002 hex: RF Tag communications in progress 0003 hex: Changing settings 0004 hex: Error

• Error Response

Byte-0	Byte-1	Byte-2	Byte-3	Byte-4	Byte-5	Byte-6	Byte-7	Byte-8
Transaction identifier		Protocol identifier		Field length		Unit identifier	Function code	Exception code
X	X	0000 hex		0003 hex		FF hex	83 hex	1 byte

Parameter	Description
Exception code	For details, refer to <i>Exception Code</i> on page 7-7 under 7-2-3 <i>Response Format for Error Completion</i> on page 7-7.

- **Execution Examples**

Execution with the Following Reader/Writer Operating Status

Mode: Run Mode, Status: Idling

TX: 000000000006FF03D3000002

RX: 000000000007FF030400010001

GET TIME INFORMATION

● Function

This command is used to check the time information from the Reader/Writer.

● Command Format

Byte-0	Byte-1	Byte-2	Byte-3	Byte-4	Byte-5	Byte-6	Byte-7	Byte-8	Byte-9	Byte-10	Byte-11
Transaction identifier		Protocol identifier		Field length		Unit identifier	Function code	Register address		Word count	
X	X	0000 hex		0006 hex		FF hex	03 hex	D400 hex		0002 hex	

Parameter	Description
Register address	The register address (D400 hex) that specifies the time information
Word count	The number of words in the time information to read (0002 hex)

● Response Formats

• Normal Response

Byte-0	Byte-1	Byte-2	Byte-3	Byte-4	Byte-5	Byte-6	Byte-7	Byte-8	Byte-9	...	Byte-12	
Transaction identifier		Protocol identifier		Field length		Unit identifier	Function code	Byte count	Time information			
X	X	0000 hex		0007 hex		FF hex	03 hex	04 hex	4 bytes			
									Actual time flag:*1 0/1	Hour: 0 to 23	Minutes: 0 to 59	Sec- onds: 0 to 59
									1 byte	1 byte	1 byte	1 byte

Parameter	Description
Byte count	The number of bytes in the time information that was read (04 hex)
Time information	<p>Gives the time information that is managed inside the Reader/Writer in 4-digit hexadecimal.</p> <p>*1 This byte indicates whether the actual time was set from the host device.</p> <p>0: The time has not been set, so the time information gives the running time since the power supply to the Reader/Writer was turned ON.</p> <p>1: The time was set, so the time information is the running time from the time set from the host device.</p>

• Error Response

Byte-0	Byte-1	Byte-2	Byte-3	Byte-4	Byte-5	Byte-6	Byte-7	Byte-8
Transaction identifier		Protocol identifier		Field length		Unit identifier	Function code	Exception code
X	X	0000 hex		0003 hex		FF hex	83 hex	1 byte

Parameter	Description
Exception code	For details, refer to <i>Exception Code</i> on page 7-7 under <i>7-2-3 Response Format for Error Completion</i> on page 7-7.

- **Execution Examples**

Execution When the Time Information in the Reader/Writer Is 09:30:10

TX: 000000000006FF03D4000002

RX: 000000000007FF030400091E0A

SET TIME INFORMATION

● Function

This command sets the time information in the Reader/Writer.

When the Reader/Writer is restarted, the time information is reset. (All zeros will be set for the actual time flag, hour, minutes, and seconds.)

● Command Format

Byte-0	Byte-1	Byte-2	Byte-3	Byte-4	Byte-5	Byte-6	Byte-7	Byte-8	Byte-9	Byte-10	Byte-11
Command Format		Protocol identifier		Field length		Unit identifier	Function code	Register address		Word count	
X	X	0000 hex		000B hex		FF hex	10 hex	D400 hex		0002 hex	

Byte-12	Byte-13	Byte-14	Byte-15	Byte-16
Byte count	Time information			
	Reserved	Hour: 0 to 23	Minutes: 0 to 59	Seconds: 0 to 59
04 hex	1 byte	1 byte	1 byte	1 byte

Parameter	Description
Register address	The register address (D400 hex) that specifies the time information
Word count	The number of words of time information (0002 hex)
Byte count	The number of bytes of time information (04 hex)
Time information	The time to set in the Reader/Writer in 8-digit hexadecimal.

● Response Formats

• Normal Response

Byte-0	Byte-1	Byte-2	Byte-3	Byte-4	Byte-5	Byte-6	Byte-7	Byte-8	Byte-9	Byte-10	Byte-11
Transaction identifier		Protocol identifier		Field length		Unit identifier	Function code	Register address		Word count	
X	X	0000 hex		0006 hex		FF hex	10 hex	D400 hex		0002 hex	

Parameter	Description
Register address	The register address from the command is set.
Word count	The word count from the command is set.

• Error Response

Byte-0	Byte-1	Byte-2	Byte-3	Byte-4	Byte-5	Byte-6	Byte-7	Byte-8
Transaction identifier		Protocol identifier		Field length		Unit identifier	Function code	Exception code
X	X	0000 hex		0003 hex		FF hex	90 hex	1 byte

Parameter	Description
Exception code	For details, refer to <i>Exception Code</i> on page 7-7 under <i>7-2-3 Response Format for Error Completion</i> on page 7-7.

- **Execution Examples**

Execution to Set the Time Information in the Reader/Writer to 09:30:10

TX: 000000000000BFF10D40000020400091E0A

RX: 0000000000006FF10D4000002

GET MULTI-READER/WRITER STATUS

● Function

This command is used to check the status of the Multi-Reader/Writer.

● Command Format

Byte-0	Byte-1	Byte-2	Byte-3	Byte-4	Byte-5	Byte-6	Byte-7	Byte-8	Byte-9	Byte-10	Byte-11
Transaction identifier		Protocol identifier		Field length		Unit identifier	Function code	Register address		Word count	
X	X	0000 hex		0006 hex		FF hex	03 hex	D500 hex		0008 hex	

Parameter	Description
Register address	Register number (D500 hex) indicating the Multi-Reader/Writer status obtained
Word count	Number of words (0008 hex) of the Multi-Reader/Writer status to be obtained

● Response Formats

- Normal Response

Byte-0	Byte-1	Byte-2	Byte-3	Byte-4	Byte-5	Byte-6	Byte-7	Byte-8
Transaction identifier		Protocol identifier		Field length		Unit identifier	Function code	Byte count
X	X	0000 hex		0013 hex		FF hex	03 hex	10 hex

Byte-9	Byte-10	Byte-11	Byte-12	Byte-13	Byte-14	Byte-15	Byte-16
Multi-Reader/Writer Status							
Reader/Writer 0 (Master Reader/Writer)		Reader/Writer 1 (Slave Reader/Writer 1)		Reader/Writer 2 (Slave Reader/Writer 2)		Reader/Writer 3 (Slave Reader/Writer 3)	
2 bytes		2 bytes		2 bytes		2 bytes	

Byte-17	Byte-18	Byte-19	Byte-20	Byte-21	Byte-22	Byte-23	Byte-24
Multi-Reader/Writer Status							
Reader/Writer 4 (Slave Reader/Writer 4)		Reader/Writer 5 (Slave Reader/Writer 5)		Reader/Writer 6 (Slave Reader/Writer 6)		Reader/Writer 7 (Slave Reader/Writer 7)	
2 bytes		2 bytes		2 bytes		2 bytes	

Parameter		Description
Byte count		The number of bytes in the Multi-Reader/Writer status that was read (10 hex)
Multi-Reader/Writer Status	Reader/Writer 0 (Master Reader/Writer)	Gives the status of the multiaccess mode of the master Reader/Writer in 4 hexadecimal digits. 0000 hex: Disabled 1000 hex: During Communications Range Extension Mode startup *1 1001 hex: During Communications Range Extension Mode operation *1 *1. It is necessary to complete connection processing for all slave Reader/Writers in order to be in operation.
	Reader/Writers 1 to 7 (Slave Reader/Writers)	This displays the status of slave Reader/Writer 1 in 4 hexadecimal digits. 0000 hex: Not registered 0001 hex: Connected 0002 hex: Not connected 0003 hex: Communication failure *2 *2. This is the state when communications with a slave Reader/Writer has failed after connection. If communications with the slave Reader/Writer has succeeded, it will shift from "Communications failure" to "Connected."

- Error Response

Byte-0	Byte-1	Byte-2	Byte-3	Byte-4	Byte-5	Byte-6	Byte-7	Byte-8
Transaction identifier		Protocol identifier		Field length		Unit identifier	Function code	Exception code
X	X	0000 hex		0003 hex		FF hex	83 hex	1 byte

Parameter	Description
Exception code	For details, refer to <i>Exception Code</i> on page 7-7 under 7-2-3 Response Format for Error Completion on page 7-7.

● Execution Examples

If the Multi-Reader/Writer status is the following:

Setting item	Description
Reader/Writer 0 (Master Reader/Writer)	During Communications Range Extension Mode startup
Reader/Writer 1 (Slave Reader/Writer)	Connected
Reader/Writer 2 (Slave Reader/Writer)	Connected
Reader/Writer 3 (Slave Reader/Writer)	Not connected
Reader/Writer 4 (Slave Reader/Writer)	Not registered
Reader/Writer 5 (Slave Reader/Writer)	Not registered
Reader/Writer 6 (Slave Reader/Writer)	Not registered
Reader/Writer 7 (Slave Reader/Writer)	Not registered

TX: 000000000006FF03D5000008

RX: 00000000013FF031010010001000100020000000000000000

7-6-9 Maintenance Commands: Log Information

GET SYSTEM ERROR LOG

● Function

This command is used to check the log of system errors that have occurred in the Reader/Writer.

The system error log is retained even when the Reader/Writer is restarted.

● Command Format

Byte-0	Byte-1	Byte-2	Byte-3	Byte-4	Byte-5	Byte-6	Byte-7	Byte-8	Byte-9	Byte-10	Byte-11
Transaction identifier		Protocol identifier		Field length		Unit identifier	Function code	Register address		Word count	
X	X	0000 hex		0006 hex		FF hex	03 hex	D600 hex		0079 hex	

Parameter	Description
Register address	The register address (D600 hex) that specifies the system error log information
Word count	The number of words in the system error log information to read (0079 hex)

● Response Formats

- Normal Response

Byte-0	Byte-1	Byte-2	Byte-3	Byte-4	Byte-5	Byte-6	Byte-7	Byte-8	Byte-9	Byte-10
Transaction identifier		Protocol identifier		Field length		Unit identifier	Function code	Byte count	Number of records	
X	X	0000 hex		00F5 hex		FF hex	03 hex	F2 hex	1 word	

Byte-11	...	Byte-26	Byte-27	...	Byte-42	...	Byte-235	...	Byte-250
Newest record in system error log			Newest record - 1 in system error log			...	Newest record - 14 in system error log		
16 bytes			16 bytes			...	16 bytes		

Time information	Error code	Reserved	Attached information 1	Attached information 2
4 bytes	2 bytes	2 bytes	4 bytes	4 bytes

Parameter	Description	
Byte count	The number of bytes in system error log (F2 hex)	
Number of records	Gives the number of records in the valid data of the system error log.	
Newest record in system error log	Time information	Gives the time information in 8-digit hexadecimal (actual time flag, hour, minutes, and seconds).
	Error code	For details, refer to 9-2-1 <i>Command Errors</i> on page 9-4.
	Reserved	(Reserved for future use as error device information.)
	Attached information 1	Additional error information 1 (00 hex if there is no attached information)
	Attached information 2	Additional error information 2 (00 hex if there is no attached information)
Newest record - 1 in system error log	---	
...	...	
Newest record - 14 in system error log	---	

• Error Response

Byte-0	Byte-1	Byte-2	Byte-3	Byte-4	Byte-5	Byte-6	Byte-7	Byte-8
Transaction identifier		Protocol identifier		Field length		Unit identifier	Function code	Exception code
X	X	0000 hex		0003 hex		FF hex	83 hex	1 byte

Parameter	Description
Exception code	For details, refer to <i>Exception Code</i> on page 7-7 under <i>7-2-3 Response Format for Error Completion</i> on page 7-7.

● Execution Examples

Execution with the Following System Error Log in the Reader/Writer

Number of records	2
Newest record	Time information: 09:31:30, Error code: 8011 hex (IP address conflict), Attached information: None
Newest record – 1	Time information: 09:30:10, Error code: 8012 hex (BOOTP server connection failed), Attached information: None

TX: 000000000006FF03D6000079

RX: 000000000F5FF03F2000201091F1E8011000000000000000000001091E0A8012
0000000000000000.....00

CLEAR SYSTEM ERROR LOG

● Function

This command clears the log of system errors (fatal errors) that is stored in the Reader/Writer.

● Command Format

Byte-0	Byte-1	Byte-2	Byte-3	Byte-4	Byte-5	Byte-6	Byte-7	Byte-8	Byte-9	Byte-10	Byte-11
Transaction identifier		Protocol identifier		Field length		Unit identifier	Function code	Register address		Word count	
X	X	0000 hex		0009 hex		FF hex	10 hex	D700 hex		0001 hex	

Byte-12	Byte-13	Byte-14
Byte count	Clear type	
02 hex	2 bytes	

Parameter	Description
Register address	The register address (D700 hex) that specifies clearing the system error log information
Word count	Number of words for the clear type (0001 hex)
Byte count	Number of bytes for the clear type (02 hex)
Clear type	0000 hex: Clear all

● Response Formats

• Normal Response

Byte-0	Byte-1	Byte-2	Byte-3	Byte-4	Byte-5	Byte-6	Byte-7	Byte-8	Byte-9	Byte-10	Byte-11
Transaction identifier		Protocol identifier		Field length		Unit identifier	Function code	Register address		Word count	
X	X	0000 hex		0006 hex		FF hex	10 hex	D700 hex		0001 hex	

Parameter	Description
Register address	The register address from the command is set.
Word count	The word count from the command is set.

• Error Response

Byte-0	Byte-1	Byte-2	Byte-3	Byte-4	Byte-5	Byte-6	Byte-7	Byte-8
Transaction identifier		Protocol identifier		Field length		Unit identifier	Function code	Exception code
X	X	0000 hex		0003 hex		FF hex	90 hex	1 byte

Parameter	Description
Exception code	For details, refer to <i>Exception Code</i> on page 7-7 under <i>7-2-3 Response Format for Error Completion</i> on page 7-7.

● Execution Examples

Execution to Clear the System Error Log in the Reader/Writer

TX: 000000000009FF10D7000001020000

RX: 000000000006FF10D7000001

GET COMMAND ERROR LOG

● Function

This command is used to check the log of command errors that have occurred in the Reader/Writer. The command error log information is cleared when the Reader/Writer is restarted.

● Command Format

Byte-0	Byte-1	Byte-2	Byte-3	Byte-4	Byte-5	Byte-6	Byte-7	Byte-8	Byte-9	Byte-10	Byte-11
Transaction identifier		Protocol identifier		Field length		Unit identifier	Function code	Register address		Word count	
X	X	0000 hex		0006 hex		FF hex	03 hex	D800 hex		0061 hex	

Parameter	Description
Register address	The register address (D800 hex) that specifies the command error log information
Word count	The number of words in the command error log to read (0061 hex)

● Response Formats

- Normal Response

Byte-0	Byte-1	Byte-2	Byte-3	Byte-4	Byte-5	Byte-6	Byte-7	Byte-8	Byte-9	Byte-10
Transaction identifier		Protocol identifier		Field length		Unit identifier	Function code	Byte count	Number of records	
X	X	0000 hex		00C5 hex		FF hex	03 hex	C2 hex	2 bytes	

Byte-11	...	Byte-34	Byte-35	...	Byte-58	...	Byte-179	...	Byte-202
Newest record in the command error log			Newest record - 1 in the command error log			...	Newest record -7 in the command error log		
24 bytes			24 bytes			...	24 bytes		

Time information	IP address of the remote device	Transaction identifier	Command code	Error code	Reader/Writer Number
4 bytes	4 bytes	2 bytes	2 bytes	2 bytes	2 bytes

Attached information 1	Attached information 2
4 bytes	4 bytes

Parameter	Description	
Number of records	Gives the number of records in the valid data of the system error log.	
Newest record in the command error log	Time information	Gives the time information in 8-digit hexadecimal (actual time flag, hour, minutes, and seconds).
	IP address of the remote device	Gives the IP address that was read in 8-digit hexadecimal. Example: C0A801C8 hex (192.168.1.200)
	Transaction identifier	The transaction identifier specified in the command that produced the error
	Command code	Gives the command code in 8-digit hexadecimal.
	Error code	For details, refer to 9-2-1 <i>Command Errors</i> on page 9-4.
	Reader/Writer Number	This displays the Reader/Writer number of the reader/writer communicating with the RF Tag in 4 hexadecimal digits. * This is 0000 hex if Multi-Reader/Writer mode is disabled or if there is a command error.
	Attached information 1	Gives additional information 1 on the error in 16-digit hexadecimal.
Attached information 2	Gives additional information 2 on the error in 16-digit hexadecimal.	

Parameter		Description
Newest record - 1 in the command error log	---	---
...
Newest record -7 in the command error log	---	---

• Error Response

Byte-0	Byte-1	Byte-2	Byte-3	Byte-4	Byte-5	Byte-6	Byte-7	Byte-8
Transaction identifier		Protocol identifier		Field length		Unit identifier	Function code	Exception code
X	X	0000 hex		0003 hex		FF hex	83 hex	1 byte

Parameter	Description
Exception code	For details, refer to <i>Exception Code</i> on page 7-7 under <i>7-2-3 Response Format for Error Completion</i> on page 7-7.

● Execution Examples

Execution with the Following Command Error Log in the Reader/Writer

Number of records	2
Newest record	Time information: 09:31:30, IP address: 192.168.1.121, Command code: 0004 hex (DATA WRITE), Error code: 1005 hex (command parameter error), Attached information: None
Newest record - 1	Time information: 09:30:10, IP address: 192.168.1.120, Command code: 0003 hex (DATA READ), Error code: 2004 hex (address error), Attached information: None

TX: 000000000006FF03D8000061

RX: 0000000000C5FF03C2000201091F1EC0A801780000000410050000000000000000000001091E0AC0A801780000000320040000000000000000...00

GET MOST RECENT COMMAND ERROR INFORMATION

● Function

This command is used to check the most recent command error information from the Reader/Writer. The most recent command error information is cleared when the Reader/Writer is restarted.

● Command Format

Byte-0	Byte-1	Byte-2	Byte-3	Byte-4	Byte-5	Byte-6	Byte-7	Byte-8	Byte-9	Byte-10	Byte-11
Transaction identifier		Protocol identifier		Field length		Unit identifier	Function code	Register address		Word count	
X	X	0000 hex		0006 hex		FF hex	03 hex	D900 hex		000C hex	

Parameter	Description
Register address	The register address (D900 hex) that specifies reading the most recent command error information
Word count	The number of words in the most recent command error information to read (000C hex)

● Response Formats

- Normal Response

Byte-0	Byte-1	Byte-2	Byte-3	Byte-4	Byte-5	Byte-6	Byte-7	Byte-8
Transaction identifier		Protocol identifier		Field length		Unit identifier	Function code	Byte count
X	X	0000 hex		001B hex		FF hex	03 hex	18 hex

Byte-9	...	Byte-12	Byte-13	...	Byte-16	Byte-17	Byte-18	Byte-19	Byte-20	Byte-21	Byte-22
Most recent command error information											
Time information		IP address of the remote device			Transaction identifier		Command code		Error code		
4 bytes		4 bytes			2 bytes		2 bytes		2 bytes		

Byte-23	Byte-24	Byte-25	Byte-26	Byte-27	Byte-28	Byte-29	Byte-30	Byte-31	Byte-32
Most recent command error information									
Reader/Writer Number		Attached information 1				Attached information 2			
2 bytes		4 bytes				4 bytes			

Parameter	Description	
Byte count	The number of bytes in the most recent command error information that was read (18 hex)	
Most recent command error information	Time information	Gives the time information in 8-digit hexadecimal
	IP address of the remote device	Gives the IP address that was read in 8-digit hexadecimal. Example: C0A801C8 hex (192.168.1.200)
	Transaction identifier	The transaction identifier specified in the command that produced the error
	Command code	Gives the command code in 8-digit hexadecimal.
	Error code	For details, refer to <i>9-2-1 Command Errors</i> on page 9-4.
	Reader/Writer Number	This displays the Reader/Writer number of the reader/writer communicating with the RF Tag in 4 hexadecimal digits. * This is 0000 hex if Multi-Reader/Writer mode is disabled or if there is a command error.
	Attached information 1	Gives additional information 1 on the error in 8-digit hexadecimal.
Attached information 2	Gives additional information 2 on the error in 8-digit hexadecimal.	

- Error Response

Byte-0	Byte-1	Byte-2	Byte-3	Byte-4	Byte-5	Byte-6	Byte-7	Byte-8
Transaction identifier		Protocol identifier		Field length		Unit identifier	Function code	Exception code
X	X	0000 hex		0003 hex		FF hex	83 hex	1 byte

Parameter	Description
Exception code	For details, refer to <i>Exception Code</i> on page 7-7 under <i>7-2-3 Response Format for Error Completion</i> on page 7-7.

- Execution Examples

Execution with the Following Most Recent Command Error Information in the Reader/Writer

Time information: 09:31:30, IP address: 192.168.1.121, Command code: 0004 hex (DATA WRITE), Error code: 1005 hex (command parameter error), Attached information: None

TX: 0000000000006FF03D900000C

RX: 0000000001BFF031801091F1EC0A801780000000410050000000000000000000

7-6-10 Maintenance Commands: RF Communications Information

GET RF TAG ADDITIONAL INFORMATION

● Function

This command is used to check the attached information (i.e., the UII (EPC code) and reception level) that resulted from communications for a single-access command with the immediately preceding RF Tag.

If communications for the immediately preceding single-access command ended in an error, attached information of 00 hex will be returned.

● Command Format

Byte-0	Byte-1	Byte-2	Byte-3	Byte-4	Byte-5	Byte-6	Byte-7	Byte-8	Byte-9	Byte-10	Byte-11
Transaction identifier		Protocol identifier		Field length		Unit identifier	Function code	Register address		Word count	
X	X	0000 hex		0006 hex		FF hex	03 hex	DA00 hex		0021 hex	

Parameter	Description
Register address	The register address (DA00 hex) for reading the attached information for RF Tag communications
Word count	0021 hex: If there is no Reader/Writer number 0022 hex: If there is a Reader/Writer number

● Response Formats

- Normal Response

Byte-0	Byte-1	Byte-2	Byte-3	Byte-4	Byte-5	Byte-6	Byte-7	Byte-8
Transaction identifier		Protocol identifier		Field length		Unit identifier	Function code	Byte count
X	X	0000 hex		0045 hex		FF hex	03 hex	1 bytes

If there is no Reader/Writer number:

Byte-9	Byte-10	Byte-11	...	Byte-72	Byte-73	Byte-74
StoredPC		UII (EPC code)			Reception level	
2 bytes		62 bytes			2 bytes	

If there is a Reader/Writer number:

Byte-9	Byte-10	Byte-11	...	Byte-72	Byte-73	Byte-74	Byte-75	Byte-76
StoredPC		UII (EPC code)			Reception level		Reader/Writer number	
2 bytes		62 bytes			2 bytes		2 bytes	

Parameter	Description
Byte count	42 hex: if there is no Reader/Writer number 44 hex: If there is a Reader/Writer number
StoredPC	Gives the StoredPC data in 4-digit hexadecimal. The upper 5 bits are the UII (EPC) word length.
UII (EPC code)	Gives the Tag-specific information according to Gen2 standards. All bytes of the UII (EPC code) section that exceed the UII (EPC) word length in the StoredPC are filled with 00 hex.
Reception level	Gives the reception level in signed hexadecimal. FFFF to FF9D hex (-1 to -99) [dBm]
Reader/Writer Number	This displays the Reader/Writer number of the reader/writer communicating with the RF Tag in 4 hexadecimal digits. * This will be 0000 hex if the Multi-Reader/Writer mode is disabled.

• Error Response

Byte-0	Byte-1	Byte-2	Byte-3	Byte-4	Byte-5	Byte-6	Byte-7	Byte-8
Transaction identifier		Protocol identifier		Field length		Unit identifier	Function code	Exception code
X	X	0000 hex		0003 hex		FF hex	83 hex	1 byte

Parameter	Description
Exception code	For details, refer to <i>Exception Code</i> on page 7-7 under <i>7-2-3 Response Format for Error Completion</i> on page 7-7.

● Execution Examples

Execution for the Following Attached Information as the Results of Reader/Writer Communications with the Immediately Preceding RF Tag

StoredPC: 3000 hex, UII (EPC code): 111122223333444455556666 hex, Reception level: -27 (FFE5 hex)

TX: 000000000006FF03DA000021

RX: 000000000045FF0342300011112222333344445555666600...00FFE5

GET NOISE LEVEL

● Function

This command measures the ambient noise level around the Reader/Writer.

● Command Format

Byte-0	Byte-1	Byte-2	Byte-3	Byte-4	Byte-5	Byte-6	Byte-7	Byte-8	Byte-9	Byte-10	Byte-11
Transaction identifier		Protocol identifier		Field length		Unit identifier	Function code	Register address		Word count	
X	X	0000 hex		0006 hex		FF hex	03 hex	DB00 hex		2 bytes	

Parameter	Description
Register address	The register address (DB00 hex) for getting the noise level
Word count	Word count of noise information from channels 1 to n * The range of the word count for each model number is as follows: V780-HMD68-ETN-JP: 000F hex V780-HMD68-ETN-KR: 0013 hex V780-HMD68-ETN-CN: 0010 hex V780-HMD68-ETN-TW: 000A hex V780-HMD68-ETN-IN/-ID/-EU/-RU: 0004 hex V780-HMD68-ETN-MY/-SG: 0008 hex V780-HMD68-ETN-US/-MX: 0032 hex

● Response Formats

- Normal Response

Byte-0	Byte-1	Byte-2	Byte-3	Byte-4	Byte-5	Byte-6	Byte-7	Byte-8
Transaction identifier		Protocol identifier		Field length		Unit identifier	Function code	Byte count
X	X	0000 hex		2 bytes		FF hex	03 hex	1 byte

Byte-9	Byte-10	Byte-m ^{*1}
Channel 1 noise level		...	Channel n noise level	
2 bytes		...	2 bytes	

Parameter	Description
Field length	Gives the total number of bytes starting from the unit identifier in 4-digit hexadecimal. * The field length for each model number is as follows: V780-HMD68-ETN-JP: 0021 hex (33) V780-HMD68-ETN-KR: 0029 hex (41) V780-HMD68-ETN-CN: 0023 hex (35) V780-HMD68-ETN-TW: 0017 hex (23) V780-HMD68-ETN-IN/-ID/-EU/-RU: 000B hex (11) V780-HMD68-ETN-MY/-SG: 0013 hex (19) V780-HMD68-ETN-US/-MX: 0067 hex (103)

Parameter	Description
Byte count	<p>Gives the total number of bytes for noise level from channel 1 to channel n in 4-digit hexadecimal.</p> <p>* The byte count for each model number is as follows: V780-HMD68-ETN-JP: 1E hex (30) V780-HMD68-ETN-KR: 26 hex (38) V780-HMD68-ETN-CN: 20 hex (32) V780-HMD68-ETN-TW: 14 hex (20) V780-HMD68-ETN-IN/-ID/-EU/-RU: 08 hex (8) V780-HMD68-ETN-MY/-SG: 10 hex (16) V780-HMD68-ETN-US/-MX: 64 hex (100)</p>
Channel 1 noise level	<p>Gives the noise level for channel 1 in signed digit hexadecimal. FFFF to FF9D hex (-1 to -99) [dBm]</p>
...	...
Channel n noise level	<p>Gives the noise level for channel n in signed digit hexadecimal. FFFF to FF9D hex (-1 to -99) [dBm]</p> <p>* The maximum number of channels for each model number is as follows: V780-HMD68-ETN-JP: 15 V780-HMD68-ETN-KR: 19 V780-HMD68-ETN-CN: 16 V780-HMD68-ETN-TW: 10 V780-HMD68-ETN-IN/-ID/-EU/-RU: 4 V780-HMD68-ETN-MY/-SG: 8 V780-HMD68-ETN-US/-MX: 50</p>

*1. The number of bytes in response depends on the model number.

Byte-m	
V780-HMD68-ETN-JP	: 39
V780-HMD68-ETN-KR	: 47
V780-HMD68-ETN-CN	: 41
V780-HMD68-ETN-TW	: 29
V780-HMD68-ETN-IN/-ID/-EU/-RU	: 17
V780-HMD68-ETN-MY/-SG	: 39
V780-HMD68-ETN-US/-MX	: 109

• Error Response

Byte-0	Byte-1	Byte-2	Byte-3	Byte-4	Byte-5	Byte-6	Byte-7	Byte-8
Transaction identifier		Protocol identifier		Field length		Unit identifier	Function code	Exception code
X	X	0000 hex		0003 hex		FF hex	83 hex	1 byte

Parameter	Description
Exception code	For details, refer to <i>Exception Code</i> on page 7-7 under <i>7-2-3 Response Format for Error Completion</i> on page 7-7.

● Execution Examples

Execution When the Reader/Writer Measures the Following Noise Levels

Channel 4 noise level: -40 dBm (FFD8 hex), Channel 5 noise level: -77 (FFB3 hex), ... , Channel 18 noise level: -77(FFB3 hex)

TX: 000000000006FF03DB00000F

RX: 000000000067FF0364FFD8FFB3...FFB3

GET COMMUNICATIONS DIAGNOSTIC INFORMATION

● Function

This command gets the most recent communications diagnostic information.

● Command Format

Byte-0	Byte-1	Byte-2	Byte-3	Byte-4	Byte-5	Byte-6	Byte-7	Byte-8	Byte-9	Byte-10	Byte-11
Transaction identifier		Protocol identifier		Field length		Unit identifier	Function code	Register address		Word count	
X	X	0000 hex		0006 hex		FF hex	03 hex	DC00 hex		002E hex	

Parameter	Description
Register address	The register address (DC00 hex) for reading the communications diagnostic information
Word count	The number of words in the communications diagnostic information to read (002E hex)

● Response Formats

- Normal Response

Byte-0	Byte-1	Byte-2	Byte-3	Byte-4	Byte-5	Byte-6	Byte-7	Byte-8
Transaction identifier		Protocol identifier		Field length		Unit identifier	Function code	Byte count
X	X	0000 hex		005F hex		FF hex	03 hex	5C hex

Byte-9	...	Byte-88
--------	-----	---------

Most recent communications diagnostic information

92 bytes

Byte-9	...	Byte-12	Byte-13	Byte-14	Byte-15	Byte-16	Byte-17	Byte-18	Byte-19	Byte-20
--------	-----	---------	---------	---------	---------	---------	---------	---------	---------	---------

Communications diagnostic information

Time information			Command code	Error code	Diagnostic results	Detailed diagnostic results
4 bytes			2 bytes	2 bytes	2 bytes	2 bytes

Byte-21	Byte-22	Byte-23	Byte-24	Byte-25	Byte-26	Byte-27	Byte-28	Byte-29	Byte-30
---------	---------	---------	---------	---------	---------	---------	---------	---------	---------

Communications diagnostic information

Reserved 1		Reserved 2		Channel used	Communications speed	Reception level
2 bytes		2 bytes		2 bytes	2 bytes	2 bytes

Byte-31	Byte-32	Byte-33	Byte-34	Byte-35	Byte-36	Byte-37	Byte-38	Byte-39	...	Byte-100
---------	---------	---------	---------	---------	---------	---------	---------	---------	-----	----------

Communications diagnostic information

Noise level	Target level	Reserved 3	Stored PC	UII (EPC code)
2 bytes	2 bytes	2 bytes	2 bytes	62 bytes

Parameter		Description
Byte count		The number of bytes in the most recent communications diagnosis information (5C hex)
Most recent communications diagnostic information ^{*1}	Time information	Gives the time information in 8-digit hexadecimal (actual time flag, hour, minutes, and seconds).
	Command code	Gives the command code in 8-digit hexadecimal.
	Error code	For details, refer to <i>Exception Code</i> on page 7-7 under <i>Response Format for Error Completion</i> on page 7-7.
	Diagnostic results	Gives the diagnostic results in 4-digit hexadecimal. FFFF hex: Error (Set when the error code is not normal.) 0000 hex: Normal 0001 hex: Insufficient power to send 0002 hex: Insufficient power to receive 0003 hex: Too much noise 0005 hex: Insufficient read data ^{*2} 0006 hex: Excessive read data ^{*2}
	Diagnostic details	Gives the diagnostic details in 4-digit hexadecimal. Bit 0: Insufficient power to send flag Bit 1: Insufficient power to receive flag Bit 2: Too much noise Bit 3: Reserved Bit 4: Insufficient data read flag Bit 5: Excessive data read flag ^{*2} Bits 6 to 15: Reserved (all zeros) ^{*2}
	Reserved 1 to 2	0000 hex: No options
	Channel used	Gives the channel used in actual communications in 4 hexadecimal digits. 0001 hex to 0064 hex (1 to 100) [CH]
	Communications speed	Gives the speed used in actual communications in 4 hexadecimal digits. 0001 hex: High-speed 0002 hex: Standard
	Reception level	Gives the reception level in signed 4-digit hexadecimal. FFFF to FF9D hex (-1 to -99) [dBm]
	Noise level	Gives the noise level in signed 4-digit hexadecimal. FFFF to FF9D hex (-1 to -99) [dBm]
	Target level	Gives the target level in 4 hexadecimal digits. 0000 to 0064 hex (0 to 100)
	Reserved 3	0000 hex: No specifications
	Stored PC	Gives the StoredPC data of the RF Tag for diagnostics in 4-digit hexadecimal. The upper 5 bits are the UII (EPC) word length.
UII (EPC code)	Gives the Tag-specific information according to Gen2 standards. All bytes of the UII (EPC code) section that exceed the UII (EPC) word length in the StoredPC are filled with 00 hex.	

*1. All of the most recent communications diagnostic information will be 00 hex if communications diagnostics are disabled.

*2. This data is output for diagnostic processing only in Focus Mode. It is not output in any other mode.

• Error Response

Byte-0	Byte-1	Byte-2	Byte-3	Byte-4	Byte-5	Byte-6	Byte-7	Byte-8
Transaction identifier		Protocol identifier		Field length		Unit identifier	Function code	Exception code
X	X	0000 hex		0003 hex		FF hex	83 hex	1 byte

Parameter	Description
Exception code	For details, refer to <i>Exception Code</i> on page 7-7 under <i>7-2-3 Response Format for Error Completion</i> on page 7-7.

● Execution Examples

Execution with the Following Most Recent Communications Diagnostic Information in the Reader/Writer

Time information: 09:31:30, Command code: 0003 hex (DATA READ), Error code: 0000 hex (normal), Diagnostic results: Insufficient power to send (0001 hex), Diagnostic details: Insufficient power to send + Insufficient power to receive (0003 hex), Reception level: -41 dBm (FFD7 hex), Noise level: -70 dBm (FFBA hex), UII (EPC code): 11...11

TX: 000000000006FF03DC00002E

RX: 0000000005FFF035C 01091F1E 0003 0000 0001 0003 0000000000000000 FFD7
FFBA 00000000 30001111...11110000...0000



Browser Interface

This section describes the V780 Reader/Writer settings and operations that you can perform from a Web browser on a computer connected to the V780 Reader/Writer.

8-1	Browser Operation Interface	8-2
8-2	Operation Interface	8-4
8-2-1	Password Entry View	8-4
8-2-2	Status	8-5
8-2-3	Network Settings	8-6
8-2-4	RF Communications Settings	8-9
8-2-5	Device Settings	8-13
8-2-6	Tuning	8-15
8-2-7	Utilities	8-17
8-2-8	Logs	8-26
8-2-9	Rebooting	8-32
8-2-10	Configuration	8-33
8-2-11	Configuration File	8-39

8-1 Browser Operation Interface

Connect the Ethernet cable and start a Web browser on the computer.

Enter the IP address of the Reader/Writer in the address field of the Web browser to display the Browser Operation Interface.

Enter `http://192.168.1.200` if you are using the default IP address.

If a Web password is not set in the Reader/Writer, the Status View will be displayed first.

To display another view, click the specified menu button.

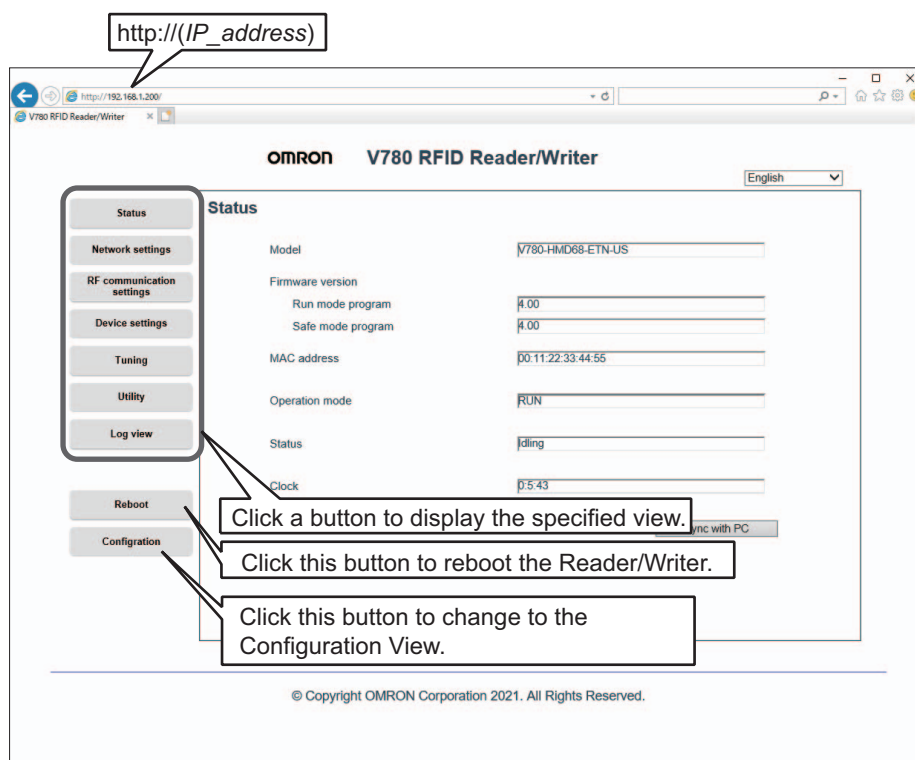

Precautions for Correct Use

Do not connect multiple Web browsers to one reader / writer.

If you operate with multiple Web browsers at the same time, it may not be displayed correctly or you may not be able to perform the correct operation.



Precautions for Correct Use

If the characters on the Web browser screen are difficult to see, use the zoom function provided by the Web browser.



Precautions for Correct Use

The operating indicator (Green) may flash because the Web browser communicates with the Reader/Writer at fixed interval.

The Web browser interface can be used in the following operating environments.

- OS: Windows 8.1/Windows 10/Windows 11
- Web Browser: Internet Explorer 11
 - Microsoft Edge
 - Google Chrome

OS	Web Browser	Propriety of use
Windows XP	IE7 to IE8	Not available
Windows 7	IE8 to IE10	Not available
Windows 8.1	IE11	Available
Windows 10	IE11	Available
Windows 10	Edge	Available
Windows 10	Chrome	Available
Windows 11	Edge	Available
Windows 11	Chrome	Available

No Java plug-in is required to use the Web browser interface.



Precautions for Correct Use

Depending on the combination of OS and Web browser, you may not be able to use the Web browser.

Please refer to the above figure and use the Web browser suitable for your OS.

If you want to use it in the conventional PC operating environment, please contact our sales staff.



Additional Information

The operating environment when using Reader/Writer earlier than firmware Ver.4.00, please refer to *For customers using Reader/Writer earlier than firmware Ver.4.00.* on page A-30 in *Section A Appendices*

8-2 Operation Interface

8-2-1 Password Entry View

If a Web password is set in the Reader/Writer, the Password Entry View will be displayed first. This view is not displayed for the default settings because a default password is not set.

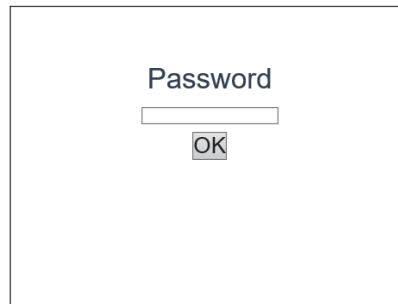

Item name	Description
Password	Enter the Web password that is set in the Reader/Writer.



Additional Information

- If an error message is displayed when you click the **OK** Button, please recheck the password that you entered.
- If you start the Reader/Writer in Safe Mode, the Password Entry View will not be displayed even if a password is set.
- If you forget the password, set it again with the SET WEB PASSWORD command, or start the Reader/Writer in Safe Mode and clear the password from the Web interface.

8-2-2 Status

Click the **Status** Button. The Status View will be displayed.

You can use this view to check the device information for the Reader/Writer.

OMRON V780 RFID Reader/Writer English ▾

Status

Network settings

RF communication settings

Device settings

Tuning

Utility

Log view

Reboot

Configuration

Status

Model	V780-HMD68-ETN-US
Firmware version	
Run mode program	4.00
Safe mode program	4.00
MAC address	11:22:33:44:55:66
Operation mode	RUN
Status	Idling
Clock	0:7:48

Sync with PC

This button sets the time on the computer into the Reader/Writer.

Item name	Description
Model	Displays the product model number.
Firmware version	Run mode program
	Safe mode program
	Version notation: xx.yy xx: Major version yy: Minor version
MAC address	Displays the MAC address of the Reader/Writer.
Operation mode	Displays the operation mode of the Reader/Writer. <i>6-1 Operation Modes</i> on page 6-3
Status	Displays the status of the Reader/Writer. Idling: The Reader/Writer is on standby. RF communications in progress: The Reader/Writer is communicating with an RF Tag. Change settings: The settings of the Reader/Writer are being changed. System error: An error has occurred in the Reader/Writer.
Clock	Displays the time since the Reader/Writer was started. Example: 0:12:34 (0 hours, 12 minutes, 34 seconds) If you click the Sync with PC Button, the time on the computer will be displayed.

8-2-3 Network Settings

TCP/IP Settings

Click the **Network settings** Button and then click the **TCP/IP** Tab.

A tab page to set the IP address and other network settings will be displayed. You can edit the settings.

Item name	Description	Default
IP address setting method	Select one of the following: Fixed setting, Obtain from BOOTP server, or Fix at the IP address which is obtained from BOOTP server.	Fixed setting
Fixed setting	Operation is performed with the fixed IP address that is set.	---
IP address	Enter the fixed IP address.	192.168.1.200
Subnet mask	Enter the subnet mask (IPv4) that is used to identify the network address and host address within the IP address.	255.255.255.0
Gateway address	Enter the IP address of the gateway to use to reach networks outside the one that the Reader/Writer is on.	192.168.1.254
Obtain from BOOTP server	The IP address will be obtained from the BOOTP server every time the power supply to the Reader/Writer is turned ON.	---
Fix at the IP address which is obtained from BOOTP server	The IP address will be obtained from the BOOTP server only one time when the Reader/Writer is restarted after this setting is made. After that, operation will be performed with the fixed IP address.	---
Device name	Enter a name to use to identify the Reader/Writer on the network. Setting range: 63 ASCII characters max.	None



Precautions for Correct Use

If you change the IP address setting method from Fixed setting to Obtain from BOOTP server or Fix at the IP address which is obtained from BOOTP server, the IP address, subnet mask, and default gateway that are set for Fixed setting become 0. If necessary, perform a backup in advance.

Port Settings

Click the **Network settings** Button and then click the **Port setting** Tab.

A tab page will be displayed to set the communications ports. You can edit the settings.

The slave reader/writer (V780-HMD68-ETN-□□-S) can not change the Modbus/TCP port number from the default.

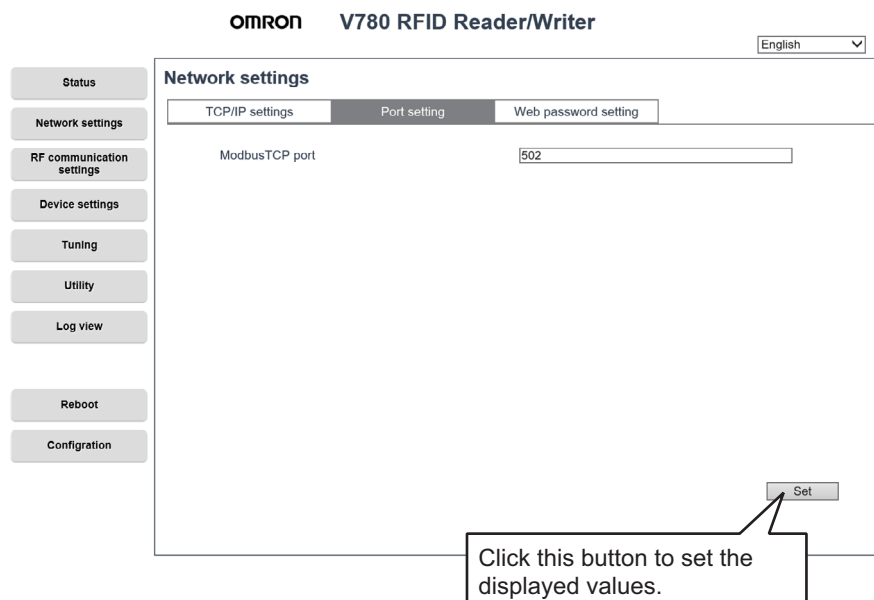

Item name	Description	Default
Modbus/TCP port	Enter the logical port number to use for Modbus/TCP communications with the host device. Setting range: 502 or 1024 to 65535	502



Precautions for Correct Use

- If you change any of the network settings, restart the Reader/Writer. The new settings will be enabled after the Reader/Writer is restarted.
- If you change the IP address and restart the Reader/Writer, the Web browser interface will not reconnect to the Reader/Writer. The browser interface will be displayed again if you set the new IP address in the address box of your Web browser.
- If you change the settings while the Reader/Writer is performing RF Tag communications, noise measurement, or other processing, an error message will be displayed. Change the settings when the Reader/Writer is in idle state.

Web Password Setting

Click the **Network settings** Button and then click the **Web password setting** Tab.

A tab page to set the Web password will be displayed. You can edit the setting.

Item name	Description	Default
Web password	Enter the login password for the Web browser interface. Setting range: 15 ASCII characters max.	None
Web password (confirmation)	Enter the login password that you entered in the Web password Box again. Setting range: 15 ASCII characters max.	None



Precautions for Correct Use

- If you change any of the network settings, restart the Reader/Writer. The new settings will be enabled after the Reader/Writer is restarted.
- If you change the settings while the Reader/Writer is performing RF Tag communications, noise measurement, or other processing, an error message will be displayed. Change the settings when the Reader/Writer is in idle state.

8-2-4 RF Communications Settings

Basic Settings

Click the **RF communication settings** Button and then click the **Basic settings** Tab.

A tab page to set the basic parameters for communications with RF Tags will be displayed. You can edit the settings.

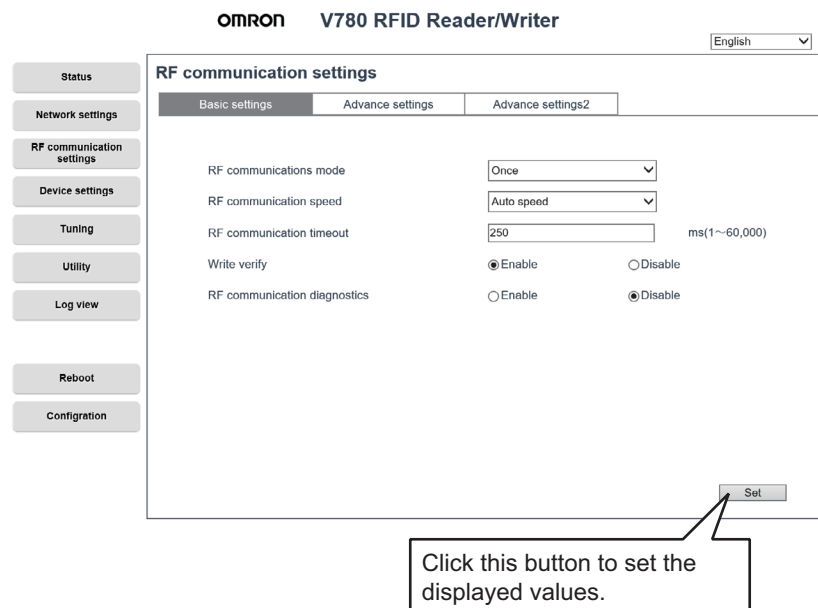

Item name	Description	Default
RF communication mode	Select the communications mode. Setting range: Once, Auto, or Focus	Once
RF communication speed	Select the speed of communications with the RF Tags. Setting range: Auto speed, High speed, or Normal speed	Auto speed
RF communication timeout	Enter the timeout time for RF communications in milliseconds. Setting range: 1 to 60,000 ms	250 ms
Write verify	Select whether or not to use write verification. Setting range: Enable or Disable	Enable
RF communication diagnostics	Select whether or not to use RF communications diagnostics. Setting range: Enable or Disable	Disable

For information on the basic settings, refer to 6-4-2 *RF Communications Conditions: Basic Settings* on page 6-24.



Precautions for Correct Use

- Click the **Set** Button. The settings will be applied immediately.
- If you change the settings while the Reader/Writer is performing RF Tag communications, noise measurement, or other processing, an error message will be displayed. Change the settings when the Reader/Writer is in idle state.

Advanced Settings

Click the **RF communication settings** Button and then click the **Advanced settings** Tab.

A tab page to set the advanced parameters for communications with RF Tags will be displayed. You can edit the settings.

OMRON V780 RFID Reader/Writer English

RF communication settings

Basic settings | **Advance settings** | Advance settings2

Transmission power

Tx power(Read) dBm(15~27)

Tx power(Write) dBm(15~27)

Channel

Gen2 session

Access password Hex(8digit)

Transmission time

Continuous time ms(400)

Stop time ms(10~1,000)

Click this button to set the displayed values.

Item name	Description	Default
Tx power (Read) and Tx power (Write)	Enter the reading transmission power and the writing transmission power separately for the antenna output. Setting range: 15 to 27	27
Channel*1	Select the frequency channel to use. For details on the settings, refer to <i>Channel</i> on page 6-26.	Auto channel
Gen2 session	Select the value for the Gen2 session flag. Setting range: S0, S1, S2, or S3	S0
Access password	Enter the RF communications access password in eight hexadecimal digits.	00000000
Transmission time	Enter the time to output radio waves continuously and the stop time when the Reader/Writer communicates with RF Tags.	—
Continuous time	Enter the maximum time to continuously output radio waves during communications command execution. Setting range: [V780-HMD68-ETN-JP] 0 or 400 to 10000 [ms] *If you set 0, the time will be infinite.*2 [Models other than V780-HMD68-ETN-JP] Cannot set the Continuous time.	*3
Stop time	Enter the time to pause output during communications command execution. Setting range: [V780-HMD68-ETN-JP] 0 or 10 to 1000 [ms] *If you set 0, the time will be 0.*2 [V780-HMD68-ETN-KR/-TW/-CN/-MY/-US/-MX] 10 to 1000 [ms] [V780-HMD68-ETN-IN/-EU/-RU] 100 to 1000 [ms]	*3

*1. The channel used can only be specified in models V780-HMD68-ETN-IN/-EU/-RU. The channel cannot be specified in the other models.

- *2. You cannot specify either one of the stop time and continuous transmission time as 0 in the model V780-HMD68-ETN-JP.
- *3. The default settings depends on the each model number. For details, refer to *Transmission Time* on page 6-28.

For information on the advanced settings, refer to *6-4-3 RF Communications Conditions: Advanced Settings* on page 6-26.



Precautions for Correct Use

- Click the **Set** Button. The settings will be applied immediately.
 - If you change the settings while the Reader/Writer is performing RF Tag communications, noise measurement, or other processing, an error message will be displayed. Change the settings when the Reader/Writer is in idle state.
-

Advanced Settings 2

Click the **RF communication settings** Button and then click the **Advanced settings 2** Tab.

A tab page to set the advanced parameters for communications with RF Tags will be displayed. You can edit the settings.

Item name	Description	Default
RSSI filter	Select whether or not to use filtering for reception levels. Setting range: Enable or Disable	Disable
High threshold	Enter the high threshold for the reception level. Setting range: 0 or -70 to -10	---
Low threshold	Enter the low threshold for the reception level. Setting range: 0 or -70 to -10	---
RF Tag select filter	Select whether or not to use filtering for RF Tag data verification.	Disable
Memory address	Enter the memory address to use for verification in the RF Tags. Setting range: 1000 to 17FF hex (UII (EPC) area) 2000 to 27FF hex (TID area) 3000 to 37FF hex (user area)	---
Verification data	Enter the data to verify with the data in the RF Tags. Setting range: 16 hexadecimal words max.	---

For information on the advanced settings, refer to *6-4-3 RF Communications Conditions: Advanced Settings* on page 6-26.



Precautions for Correct Use

- Click the **Set** Button. The settings will be applied immediately.
- If you change the settings while the Reader/Writer is performing RF Tag communications, noise measurement, or other processing, an error message will be displayed. Change the settings when the Reader/Writer is in idle state.

8-2-5 Device Settings

Operation Indicator Custom Settings

Click the **Device settings** Button and then click the **LED custom settings** Tab.

A tab page to customize the operation indicators on the Reader/Writer will be displayed. You can edit the settings.

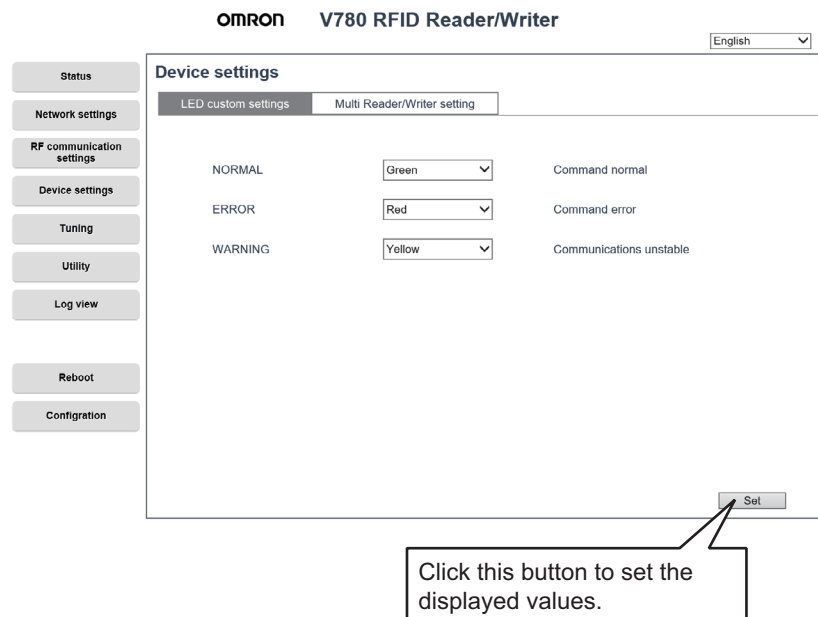

Item name	Description	Default
Command normal (NORMAL)	Select the color for the indicators to light when processing a communications command or another command from the host device is completed normally. Setting range: Red, Green, Blue, Yellow, Cyan, Magenta, White, or OFF	Green
Command error (ERROR)	Select the color for the indicators to light when processing a communications command or another command from the host device ends in an error. Setting range: Red, Green, Blue, Yellow, Cyan, Magenta, White, or OFF	Red
Unstable communications (WARNING)	Select the color for the indicators to light when an unstable communication is detected while communications diagnosis is enabled. Setting range: Red, Green, Blue, Yellow, Cyan, Magenta, White, or OFF	Yellow

For details on custom settings for operation indicators, refer to *6-4-4 Device Settings* on page 6-31.



Precautions for Correct Use

- If you change any of the device settings, restart the Reader/Writer. The settings will be applied after the Reader/Writer is restarted.
- If you change the settings while the Reader/Writer is performing RF Tag communications, noise measurement, or other processing, an error message will be displayed. Change the settings when the Reader/Writer is in idle state.

Multi-Reader/Writer Setting

Click the **Device settings** Button and then click the **Multi-Reader/Writer setting** Tab.

A tab page to customize the multi-reader/writer on the Reader/Writer will be displayed.

The slave reader/writer (V780-HMD68-ETN-□□-S) and Reader/Writer set to SLAVE mode can not change the multi reader/writer configuration setting.

OMRON V780 RFID Reader/Writer English ▼

Status

Network settings

RF communication settings

Device settings

Tuning

Utility

Log view

Reboot

Configuration

Device settings

LED custom settings Multi Reader/Writer setting

Multi Reader/Writer mode Disable Enable Field extension mode ▼

	IP address	Status	Tx power(Read)	Tx power(Write)
Slave Reader/Writer1	<input type="text" value="192.168.1.201"/>	Not registered	<input type="text" value="27"/> dBm(15~27)	<input type="text" value="27"/> dBm(15~27)
Slave Reader/Writer2	<input type="text" value="192.168.1.202"/>	Not registered	<input type="text" value="27"/> dBm(15~27)	<input type="text" value="27"/> dBm(15~27)
Slave Reader/Writer3	<input type="text" value="192.168.1.203"/>	Not registered	<input type="text" value="27"/> dBm(15~27)	<input type="text" value="27"/> dBm(15~27)
Slave Reader/Writer4	<input type="text"/>	Not registered	<input type="text" value="27"/> dBm(15~27)	<input type="text" value="27"/> dBm(15~27)
Slave Reader/Writer5	<input type="text"/>	Not registered	<input type="text" value="27"/> dBm(15~27)	<input type="text" value="27"/> dBm(15~27)
Slave Reader/Writer6	<input type="text"/>	Not registered	<input type="text" value="27"/> dBm(15~27)	<input type="text" value="27"/> dBm(15~27)
Slave Reader/Writer7	<input type="text"/>	Not registered	<input type="text" value="27"/> dBm(15~27)	<input type="text" value="27"/> dBm(15~27)

Click Update Button to re-get the status of each Slave Reader/Writer stored in the Master Reader/Writer.
 * The status of the Slave Reader/Writer stored in the Master Reader/Writer varies under the following conditions.

1. Multi Reader Writer Mode is during normal or abnormal startup
2. From Master Reader/Writer to Slave Reader/Writer during communications failed or success.

Click this button to set the displayed values.

Item name	Description	Default
Multi-Reader/Writer Mode	Select whether or not to use the Multi-Reader/Writer mode. Setting range: Enabled or Disabled	Disable
Mode Selection	This selects the mode if the Multi-Reader/Writer mode is enabled. Setting Range: Communications Range Extension Mode	
Slave Reader/Writer Status	This gives the status of each slave Reader/Writer. Connected: (Green) Not connected: (Red) Communications failed: (Red) Not registered: (Gray)	
IP address	This gives the IP addresses assigned to each Reader/Writer.	
Tx power(Read)	This gives the value of the read transmission power, and a level bar, for each slave Reader/Writer.	
Tx power(Write)	This gives the value of the write transmission power, and a level bar, for each slave Reader/Writer.	

8-2-6 Tuning

Transmission Power Tuning

Click the **Utility** Button, and then click the **Transmission power tuning** Tab. A tab page to automatically adjust the transmission powers of the Reader/Writer will be displayed. You can adjust or set the transmission power separately for read communications and write communications. When the Multi-Reader/Writer function is enabled, it is possible to select the reader/writer subject to automatic adjustment and setting.



Precautions for Correct Use

This tab page cannot be used if the Reader/Writer is started in Safe Mode or SLAVE Mode. Use this tab page when the Reader/Writer is operating in Run Mode.

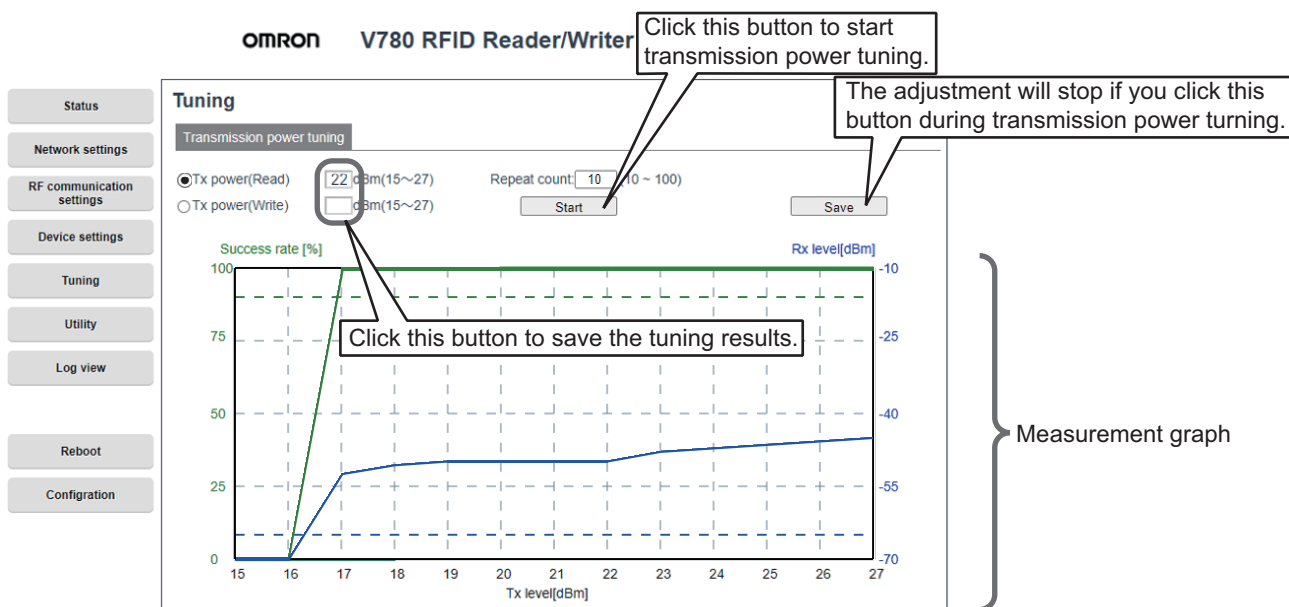

8-2 Operation Interface

8

8-2-6 Tuning

Item name	Description	Default
Tx power (Read) and Tx power (Write)	Select the transmission power to adjust: reading or writing. If tuning is completed successfully, the transmission power that was determined to be optimum will be displayed. If tuning fails, -1 will be displayed.	---
Measurement graph	During tuning, the broken-line graph will show the communications success rates and reception levels against time for each transmission power.	---
Communications success rate	The optimum power is determined based on a success rate of 90% or higher. This displays the slave Reader/Writers to which the master reader/writer is connected.	---
Reception level	The optimum power is determined based on a level of -65 dBm or higher.	---
Repeat count	Specify the number of repeat count when tuning. The larger the number of repeat count, the longer the tuning time, but the more accurate the transmission power tuning. Setting range: 10 to 100	10

For information on transmission power tuning, refer to *6-8-1 Transmission Power Tuning* page 6-13.

● Saving Files

You can click the **Save** Button on the Transmission Power Tuning Tab Page to save the results of transmission power tuning at a specified path and file name. The transmission power tuning results are saved in a CSV file in the following format.

```

CSV Format
Tx level[dBm], Success rate[%], RX level[dBm]
15, <communications_success_rate>, <reception_level>
:      :
27, <communications_success_rate>, <reception_level>
Tuning result :, before=XX[dBm], after=YY[dBm]
  
```

Item name	Description	Remarks
Tx level[dBm]	Gives the transmission powers that were swept through during tuning. 15 to 27	
Success rate[%]	Gives the communications success rates for the RF Tags measured for each transmission power. 0 to 100	
Rx level[dBm]	Gives the transmission levels measured for each transmission power. 0 or -1 to -99	
Tuning result : before=XX[dBm], after=YY[dBm]	Gives the tuning results. XX: Gives the transmission power that was set before tuning. YY: Gives the transmission power that was set after tuning. (If tuning fails, the value will be -1.)	

8-2-7 Utilities

RF Tag Access

Click the **Utility** Button, and then click the **RF Tag access** Tab.

A tab page to use RF communications commands to access RF Tags will be displayed. You can use this tab page to check operation for reading and writing the RF Tag UIIs (EPC codes) or data at any RF Tag addresses.



Precautions for Correct Use

This tab page cannot be used if the Reader/Writer is started in Safe Mode or SLAVE Mode. Use this tab page when the Reader/Writer is operating in Run Mode.

Item name	Description
RF communications command	Select the command to send. Setting range: ID read (ID READ), ID write (ID WRITE), Data read (DATA READ), or Data write (DATA WRITE)
Data address	Enter the first RF Tag address to read or write in four hexadecimal digits. Setting range: 0000 to 3FFF hex
Data size	If you specify reading data, enter the data size to read in four hexadecimal digits. If you specify writing data, the Write data box will display the count of the data size in four hexadecimal digits. Setting range: 0001 to 0078 hex
Write data	Enter hexadecimal words for the data to write to the RF Tag. Setting range: 120 words max.
Command	The command to send will be displayed.
Repeat	Select this check box to repeatedly send the command.
Response	The response from the Reader/Writer will be displayed.
Result	The communications result and a description will be displayed. The display color depends on the communications result, as follows: <ul style="list-style-type: none"> • Normal: Green • Warning: Yellow • Error: Red

Item name	Description
Time	The time required to communicate with the RF Tag will be displayed.
Command/Response Log	A history of communications between the Reader/Writer and RF Tag will be displayed. [Tx]: The send ModbusTCP command is displayed. [Rx]: Result of the response is displayed.
Summary	The maximum, minimum, and average communications times will be displayed.
No. of comms	The number of communications between the Reader/Writer and RF Tag will be displayed.

For information on RF Tag access, refer to *6-9-1 RF Tag Access* on page 6-46.

RF Tag Scanning

Click the **Utility** Button, and then click the **RF Tag scan** Tab.

A tab page to scan for RF Tags will be displayed. You can use this tab page to check for RF Tags in the communications field of the Reader/Writer.

Results of RF Tag scanning are displayed for up to 64 RF Tags.



Precautions for Correct Use

This tab page cannot be used if the Reader/Writer is started in Safe Mode or SLAVE Mode. Use this tab page when the Reader/Writer is operating in Run Mode.

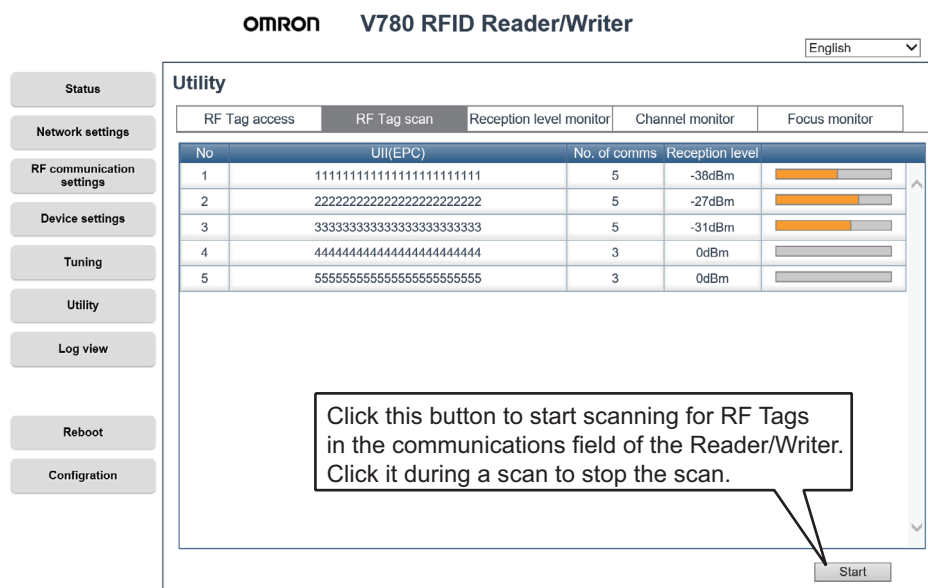

Item name	Description	Remarks
No	Displays the index numbers of the RF Tags.	
UII (EPC)	Displays the UIIs (EPC codes) of the RF Tags that were detected in the scan.	
No. of comms	Displays the numbers of communications with the RF Tags during the scan.	
Reception level	Displays the most recent reception levels measured during the scan numerically and as a bar graph.	

For information on RF Tag scanning, refer to 6-9-2 *RF Tag Scanning* on page 6-47.

Reception Level Monitor

Click the **Utility** Button, and then click the **Reception level monitor** Tab.

A tab page to monitor the reception levels from RF Tags will be displayed. You can use this tab page to adjust the installation and check the communications field.

When the Multi-Reader/Writer function is enabled, it is possible to select multiple Reader/Writers subject to communications with RF Tags.

Results of RF Tag monitoring are displayed for up to 8 RF Tags.



Precautions for Correct Use

This tab page cannot be used if the Reader/Writer is started in Safe Mode or SLAVE Mode. Use this tab page when the Reader/Writer is operating in Run Mode.

Click this button to start measurements to monitor the reception power. If you click it while measurements are being taken, the measurements will stop.

Item name	Description	Remarks
Single	Select this option to check the reception level for just one RF Tag.	
Multi	Select this option to check the reception level for more than one RF Tag.	
Measurement graph	This broken-line graph displays the reception level against time for each RF Tag during monitoring.	The data is plotted for 60 s.
RSSI filter	Select whether to enable or disable the RSSI filter set in the Reader/Writer during monitoring.	Default: Disable*1
RF Tag list	Ull (EPC)	This list displays the Ulls (EPC codes) of the RF Tags that were detected during monitoring.
	No. of comms	Displays the numbers of communications with the RF Tags during monitoring.
	Reception level	Displays the current reception levels measured during monitoring numerically and as a bar graph.

*1. Select Disable when testing like Ver.3.01 or earlier.

For information on reception level monitoring, refer to 6-9-3 *Reception Level Monitor* on page 6-48.

● Saving Files

You can click the **Save** Button on the Reception Level Monitor Tab Page to save the reception level monitoring information that was measured at a specified path and file name. The measurement results are saved in a CSV file in the following format.

<p>CSV Format</p> <p>No, Time, UII (EPC), Reception level[dBm]</p> <p>1 <time>, <UII (EPC code)>, <reception_level></p> <p>2 : : :</p>
--

Item name	Description	Remarks
No	Gives index numbers in chronological order. Single: 1 to 1,800 (100-ms sampling × 1,800 samples) Multi: 1 to 360 (500-ms sampling × 360 samples)	Data is output for up to 3 minutes.
Time	Displays the times of communications with the RF Tags during monitoring. hh:mm:ss.sss hh: hour, mm: minutes, ss.sss: seconds (millisecond increments)	The time is synchronized with the computer on which the Web browser is running.
UII (EPC)	Gives the UIIs (EPC codes) in hexadecimal of the RF Tags that were detected during monitoring. XX ... XX hex	
Reception level[dBm]	Gives the reception levels measured during monitoring. 0 or -1 to -99	The reception level will be 0 if a communications error occurs.

- Multiple Reader/Writers is enabled

The measurement results of the reception level monitor are saved in a CSV file in the following format with the Reader/Writer number attached.

The reception level trend can be checked for each Reader/Writer using the Excel filter function.

CSV Format

```
No, Time, R/W No, UII(EPC), Reception level[dBm]
1 <Time 1>, 0, <UII (EPC code)>, <Reception Level>
1 <Time 1>, 0, <UII (EPC code)>, <Reception Level> ← Result when measured with Reader/Writer 0 (2 RF tags)
1 <Time 1>, 0, <UII (EPC code)>, <Reception Level>
1 <Time 1>, 1, <UII (EPC code)>, <Reception Level> ← Result when measured with Reader/Writer 1 (1 RF tag)
1 <Time 1>, 1, <UII (EPC code)>, <Reception Level> ← Result when measured with Reader/Writer 2 (3 RF tags)
1 <Time 1>, 2, <UII (EPC code)>, <Reception Level>
1 <Time 1>, 2, <UII (EPC code)>, <Reception Level>
1 <Time 1>, 3, <UII (EPC code)>, <Reception Level> ← Result when measured with Reader/Writer 3 (2 RF tag)
1 <Time 1>, 3, <UII (EPC code)>, <Reception Level>
2 <Time 1>, 0, <UII (EPC code)>, <Reception Level>
: : : : :
```

* The number of saving item per one communications (the number of each index items) depend on the number of Reader/Writers and RF tags.

Item name	Description	Remarks
No	Gives index numbers in chronological order. Single: 1 to 1,800 (100-ms sampling × 1,800 samples) Multi: 1 to 360 (500-ms sampling × 360 samples)	Data is output for up to 3 minutes.
Time	Displays the times of communications with the RF Tags during monitoring. hh:mm:ss.sss hh: hour, mm: minutes, ss.sss: seconds (millisecond increments)	The time is synchronized with the computer on which the Web browser is running.
R/W No.	This gives the measured Reader/Writer number. 0 to 7	

Item name	Description	Remarks
UII (EPC)	Gives the UIIs (EPC codes) in hexadecimal of the RF Tags that were detected during monitoring. XX ... XX hex	
Reception level[dBm]	Gives the reception levels measured during monitoring. 0 or -1 to -99	The reception level will be 0 if a communications error occurs.



Precautions for Correct Use

To display Time in milliseconds in Excel, you need to change the display format of the cell.
Display format (user definition): "hh: mm: ss.000"

Channel Monitor

Click the **Utility** Button, and then click the **Channel monitor** Tab.

A tab page to monitor the noise level on each channel will be displayed. You can use this tab page to check the channels that are used by nearby Reader/Writers or to check the level of radio wave interference.

When the Multi-Reader/Writer function is enabled, it is possible to select the reader/writer subject to noise measurement.



Precautions for Correct Use

This tab page cannot be used if the Reader/Writer is started in Safe Mode or SLAVE Mode. Use this tab page when the Reader/Writer is operating in Run Mode.

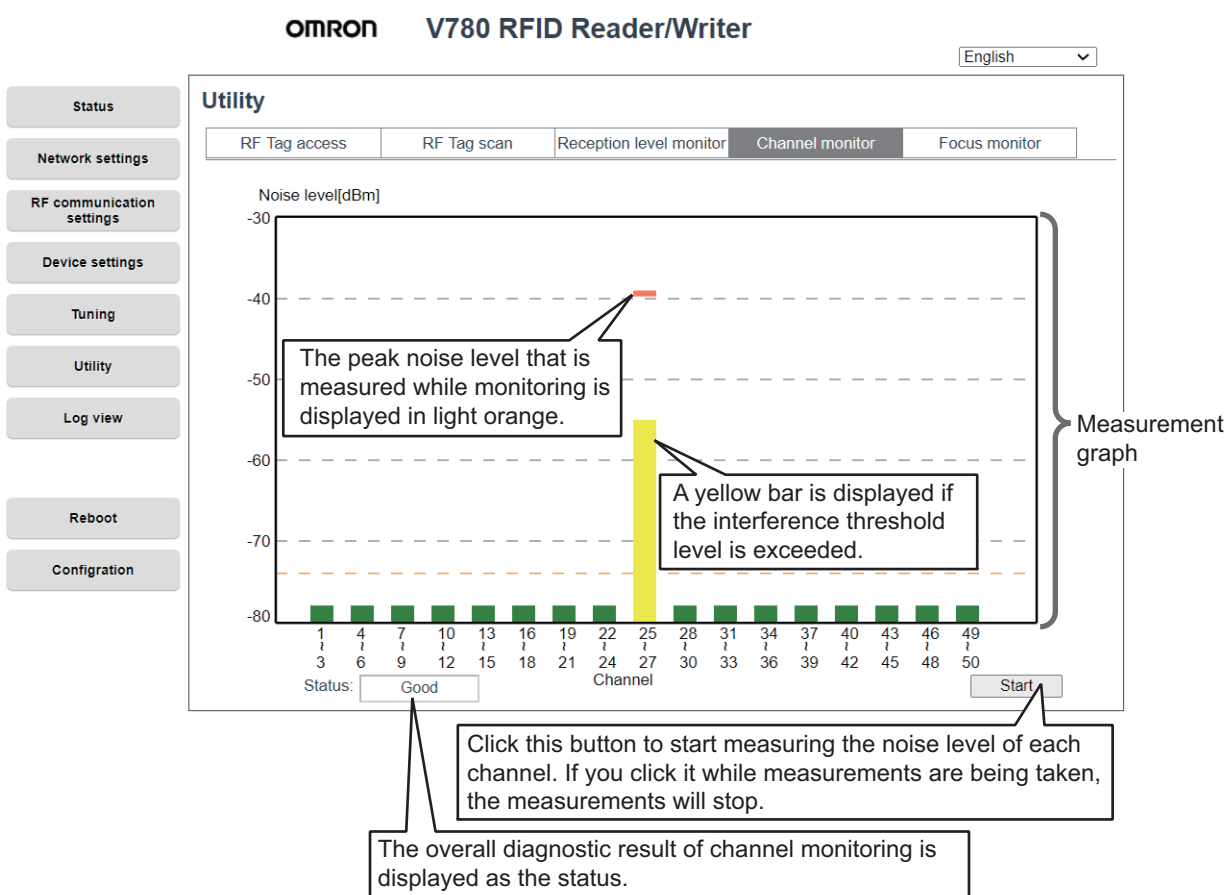

Note The channel monitor tab page depends on the model number.

Item name	Description	Remarks
Measurement graph	During monitoring, the noise level of each channel is displayed on a bar graph. The color of a bar is green if the noise level is smaller than -74 dBm and yellow if it is larger.	
Status	The diagnostic result of channel monitoring is displayed as "Good" or "Warning." If "Good" is displayed, the ambient noise environment is good. If "Warning" is displayed, there is too much interference.	

For information on channel monitoring, refer to 6-9-4 Channel Monitor on page 6-52.

Focus Monitor

Click the **Utility** Button, and then click the **Focus monitor** Tab.

A tab page to monitor the status when the Reader/Writer's Focus Mode is used will be displayed. You can use this tab page to check the target level indexes that determine which RF Tag is in front of the Reader/Writer.

Results of RF Tag monitoring are displayed for up to 64 RF Tags.



Precautions for Correct Use

This tab page cannot be used if the Reader/Writer is started in Safe Mode. Use this tab page when the Reader/Writer is operating in Run Mode.

Click this button to start measurements for focus monitoring. If you click it while measurements are being taken, the measurements will stop.

Click this button to save the measured target level information.

Measurement graph

RF Tag list

UII(EPC)	No. of comms	Target level
11111111111111111111111111111111	260	0
222222222222222222222222222222	255	0
333333333333333333333333333333	259	0

Item name	Description	Remarks
Testing	Select this option to test operation for communications in Focus Mode.	
Read ID	Click this button to execute test communications with ID READ during monitoring. When you click this button, the RF Tag with the highest target level on the right edge of the measurement graph will be selected as the RF Tag in front of the Reader/Writer.	
Result	The UII (EPC code) of the RF Tag that was communicated with is displayed as the result of test communications with ID READ. If communications failed, the background will change to red.	
Operating	Select this operation to check the target levels of the Reader/Writer during operation in Focus Mode.	
Measurement graph	This broken-line graph displays the target level against time for each RF Tag during monitoring.	The data is plotted for 60 s.
RF Tag list	UII (EPC code)	This list displays the UIIs (EPC codes) of the RF Tags that were detected during monitoring.
	No. of comms	Displays the numbers of communications with the RF Tags during monitoring.
	Target level	Displays the current target levels measured during monitoring numerically and as a bar graphs.

For information on focus monitoring, refer to 6-9-5 *Focus Monitor* on page 6-53.

● Saving Files

You can click the **Save** Button on the Focus Monitor Tab Page to save the focus information at a specified path and file name. The focus information is saved in a CSV file in the following format.

CSV Format	
No, Time, UII (EPC), Target level	
1 <time>, <UII (EPC code)>, <target_level>	
2 <time>, <UII (EPC code)>, <target_level>	
3 <time>, <UII (EPC code)>, N/A (Test ID READ)	← This is displayed when testing communications with ID READ.
4 : : :	

Item name	Description	Remarks
No	Gives index numbers in chronological order. 1 to 360 (500-ms sampling × 360 samples)	Data is output for up to 3 minutes.
Time	Gives the time when the RF Tag target level was measured during monitoring. hh:mm:ss.sss hh: hour, mm: minutes, ss.sss: seconds (millisecond increments)	The time is synchronized with the computer on which the Web browser is running.
UII (EPC)	Gives the UIIs (EPC codes) of the RF Tags that were detected during monitoring in hexadecimal. XX ... XX hex	
Target level	Gives the target level measured during monitoring. 00 to 100: Target level When test communications with ID READ are performed, the following text is output. "N/A(Test ID READ)"	The target level for RF Tag what have already executed the RF communications command will be 0.

8-2-8 Logs

Command Error Log

Click the **Log view** Button, and then click the **Command error log** Tab.

The Command Error Log Tab Page will be displayed. You can check the command error information that was returned by the Reader/Writer. If you select one of the records in the list, details for the record will be displayed.

Item name	Description	Remarks
No.	Displays the log record number. The lower numbers are assigned to the most recent records.	
Time	Time	
IP address	Displays the IP address of the host device that sent the Modbus/TCP command.	
Transaction ID	Displays the transaction ID of the Modbus/TCP command received by the Reader/Writer.	
Command name	Displays the command code and command name of the Modbus/TCP command received by the Reader/Writer.	
Error name	Displays the error name and error code.	For details, refer to <i>9-3 Errors and Countermeasures</i> on page 9-8.
Additional info 1	Display codes that provide supplemental error information.	
Additional info 2		

For details on the command error log, refer to *9-2-1 Command Errors* on page 9-4.

System Error Log

Click the **Log view** Button, and then click the **System error log** Tab.

The System Error Log Tab Page will be displayed. You can check the system error information that was detected by the Reader/Writer. If you select one of the records in the list, details for the record will be displayed.

OMRON V780 RFID Reader/Writer English ▾

- Status
- Network settings
- RF communication settings
- Device settings
- Tuning
- Utility
- Log view
- Reboot
- Configuration

Log view

Command error log System error log RF communications diagnostics log

No	Time	Level	Error name
1	0:00:00	Major fault	System configuration error
2	0:00:01	Minor fault	BOOTP server connection error
3	0:00:05	Minor fault	IPAddress duplication error
4			
5			
6			
7			
8			

List

No	1
Error name	0xF001 : System configuration error
Additional info 1	00000000
Additional info 2	00000000

A mistake was detected in the system program or system data stored in memory in the Reader/Writer.

Details

Update Clear

Click this button to refresh the display.

Click this button to delete log information.

Item name	Description	Remarks
No.	Displays the log record number. The lower numbers are assigned to the most recent records.	
Time	Displays the time when the system error was detected by the Reader/Writer.	
Level	Displays the level of the system error as follows: Minor fault or Major fault	
Error name	Displays the error code and error name.	For details, refer to 9-3 <i>Errors and Countermeasures</i> on page 9-8.
Additional info 1	Display codes that provide supplemental error information.	
Additional info 2		

For details on the system error log, refer to 9-2-1 *Command Errors* on page 9-4.

RF Communications Diagnostics Log

Click the **Log view** Button, and then click the **RF communications diagnostics log** Tab.

The Communications Diagnostics Log Tab Page will be displayed. You can use this tab page to check the results of RF communications diagnostics.



Precautions for Correct Use

This tab page cannot be used if the Reader/Writer is started in Safe Mode. Use this tab page when the Reader/Writer is operating in Run Mode.

● Communications Diagnostic Information Display

If you select one of the records in the list, details for the record will be displayed.

OMRON V780 RFID Reader/Writer English

Status

Network settings

RF communication settings

Device settings

Tuning

Utility

Log view

Reboot

Configuration

Log view

Command error log System error log **RF communications diagnostics log**

Total : 22 Warning : 3 Error : 4 Graph

No	Time	Command	Result	Diagnostics result	UID(EPC)
1	0:36:14	ID read	Normal	Normal	0011
2	0:36:14	ID read	Normal	Normal	0011
3	0:36:14	ID read	Error	RF Tag missing error	
4	0:36:14	ID read	Normal	Normal	0011
5	0:36:14	ID read	Normal	Normal	0011
6	0:36:14	ID read	Warning	Too much noise	0011
7	0:36:14	ID read	Warning	Too much noise	0011

List

No	6
Command	0001 : ID read
Diagnostics result	0003 : Too much noise
Diagnostics details	0x0004 Reception level[dBm] -19 Noise level[dBm] -60
Used channel	5 RF speed High speed Target level 0

The ambient noise level around the Reader/Writer is high.

[Probable cause/Workaround]

1.
Probable cause : Communications performance was reduced due to the influence of reflected radio waves.
Workaround : Change the position of structure or the Reader/Writer and find the best radio wave environment.

Details

Update Save Clear

Click this button to get the most recent record information in the RF communication diagnostics log from the Reader/Writer and refresh the display.

Click this button to save the record information displayed in the RF communications diagnostic information log.

Click this button to delete the RF communications log information in the Reader/Writer.

Item name	Description	Remarks
No.	Displays the log record number. The lower numbers are assigned to the most recent records.	
Time	Displays the time when the Reader/Writer executed the RF communications command.	
Command	Displays the command code and command name of the command executed by the Reader/Writer.	
Result	Displays the execution result for the RF communications command. Normal (normal communications), Warning (unstable communications), or Error (communications error)	
Diagnostic result	“Normal” will be displayed if the RF communications result was Normal. The communications result and diagnosis code will be displayed if the communications result was Warning. The error code and error name will be displayed if the communications result was Error.	
UII (EPC)	Displays the UIIs (EPC codes) of the RF Tags that were detected in communications diagnostics.	
Diagnostic details	Displays all diagnostic results detection status as bit information in four hexadecimal digits.	
Reception level	Displays the reception level measured during communications diagnostics.	
Noise level	Displays the noise level measured during communications diagnostics.	
Channel	Displays the channel that the Reader/Writer communicated with the RF Tag.	
RF communications speed	Displays the communications speed that the Reader/Writer communicated with the RF Tag.	
Target level	Displays the target level measured during communications diagnostics.	
Probable Cause and Workaround	Displays the probable causes and workarounds for unstable communications.	

For details on the RF communications diagnostics log, refer to *9-2-1 Command Errors* on page 9-4.

● **Communications Diagnostic Information Graph Display**

Click the **Graph** Button on the display of RF communications diagnostics information to display the Graph View. The RF communications diagnostics information will be displayed on a bar graph against time so that you can quantitatively check the leeway in communications.

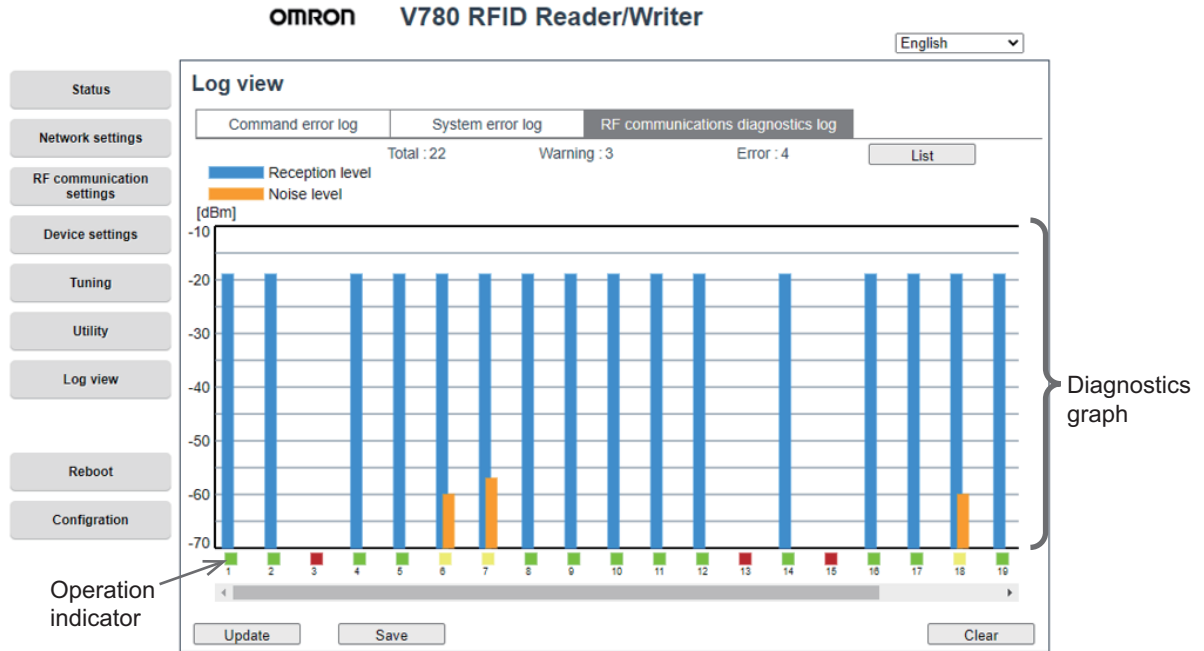

Item name		Description	Remarks
Diagnostics graph	Reception level	Displays the reception level from RF communications diagnostics with a blue bar.	
	Noise level	Displays the noise level from RF communications diagnostics with an orange bar.	
	Operation indicator	Displays the operation indicator color for RF communications diagnostics as green, yellow, or red.	These colors will not change even if you set operation indicator custom colors. They will display the default lighting colors.

For details on the RF communications diagnostics log, refer to 9-2-1 *Command Errors* on page 9-4.

● Saving Files

You can click the **Save** Button on the RF Communications Diagnostics Log Tab Page to save the RF communications diagnostics log at a specified path and file name. The RF communications diagnostics log information is saved in a CSV file in the following format.

CSV Format	
No,	Time, Command, Result, Diagnostics result, Diagnostic details, Reception level[dBm], Noise level[dBm], UII (EPC)
1	<time>, <command_name>, <RF_communications_result>, <diagnostic_result>, <diagnostic_details>, <reception_level>, <noise_level>, <UUI (EPC code)>
2	:
Total,	XX
Warning,	YY
Error,	ZZ

Item name	Description	Remarks
No	Gives the log record number. 1 to 8192	
Time	Gives the time when the Reader/Writer executed the RF communications command. hh:mm:ss hh: hour, mm: minutes, ss: seconds (second increments)	
Command	Gives the name of the command that was executed by the Reader/Writer. "Command name text"	
Result	Gives the execution result for the RF communications command. Normal: Normal communications Warning: Unstable communications Error: Communications error	
Diagnostics result	Gives the communications diagnostic results. Normal Insufficient power to send Insufficient power to receive Too much noise Insufficient read data Excessive read data Error name text: RF Tag communications error name	
Diagnostic details	Gives all diagnostic results detection status as bit information in four hexadecimal digits. XXXX hex	
Reception level[dBm]	Gives the reception level measured during communications diagnostics. 0 or -1 to -99	The level will be 0 if the result is Error.
Noise level[dBm]	Gives the noise level measured during communications diagnostics. 0 or -1 to -99	
Channel	Displays the channel that the Reader/Writer communicated with the RF Tag.	
RF communications speed	Displays the communications speed that the Reader/Writer communicated with the RF Tag.	
Target level	Displays the target level measured during communications diagnostics.	
UUI (EPC)	Gives the UIIs (EPC codes) of the RF Tags that were detected during RF communications diagnostics in hexadecimal. XX ... XX hex	
Total	Gives the total number of log records in decimal.	
Error	Gives the number of communications errors in the log in decimal.	
Warning	Gives the number of unstable communications in the log in decimal.	

8-2-9 Rebooting

When network settings have been changed and you click the **Reboot** Button on one of the displays, the Reader/Writer will be restarted and the changes to the setting will be applied.

If you click the **Reboot** Button, a Confirm Reboot Dialog Box will be displayed.

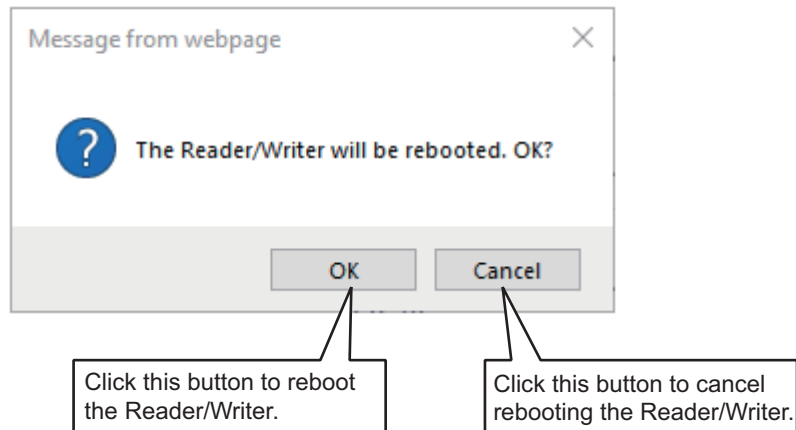

The following dialog box is displayed after the Reader/Writer has finished rebooting. Click the **OK** Button to connect to the Reader/Writer.

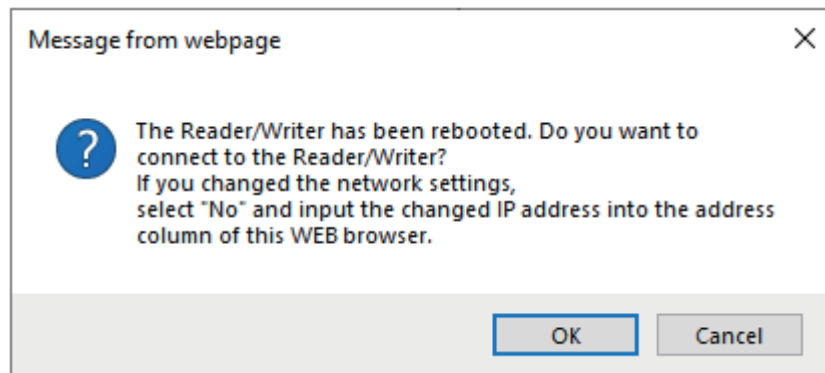

The following dialog box is displayed after reconnecting to the Reader/Writer. Click the **OK** Button.

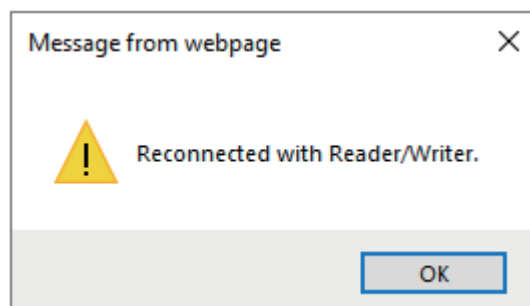

Precautions for Correct Use

If reconnection fails and an error is displayed, check the connection with the Reader/Writer and restart your browser.

8-2-10 Configuration

You can save a configuration file (INI file) that contains the configuration information from the Reader/Writer in the computer. You can also send a configuration file to the Reader/Writer to change all of the configuration information in the Reader/Writer. Click the **Default** Button to return the settings in the Reader/Writer to the default settings.

To display the Configuration View, click the **Configuration** Button at the bottom of the Browser Operation Interface.

You can click the **Status** Button at the bottom left of the Configuration View to return to the original status.

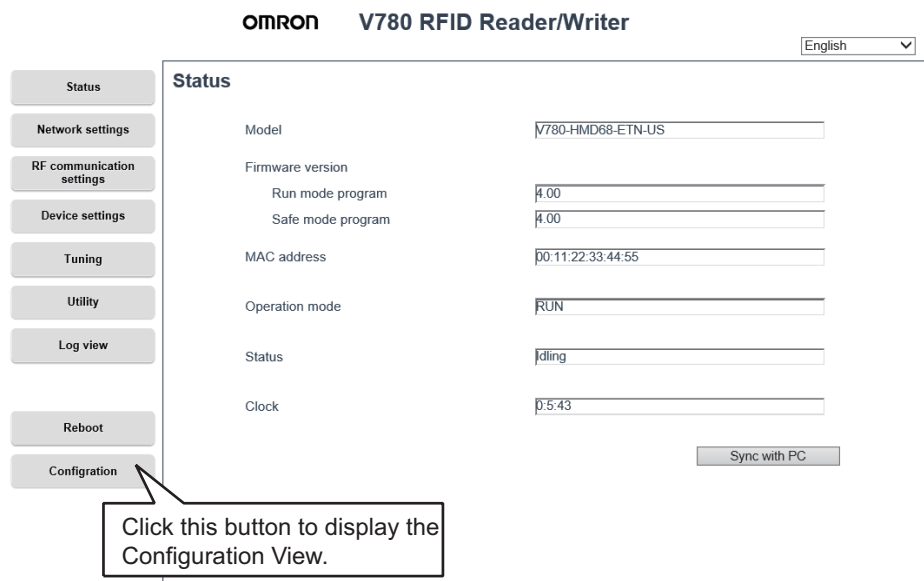

Click the **Configuration** Button to display the Configuration View.

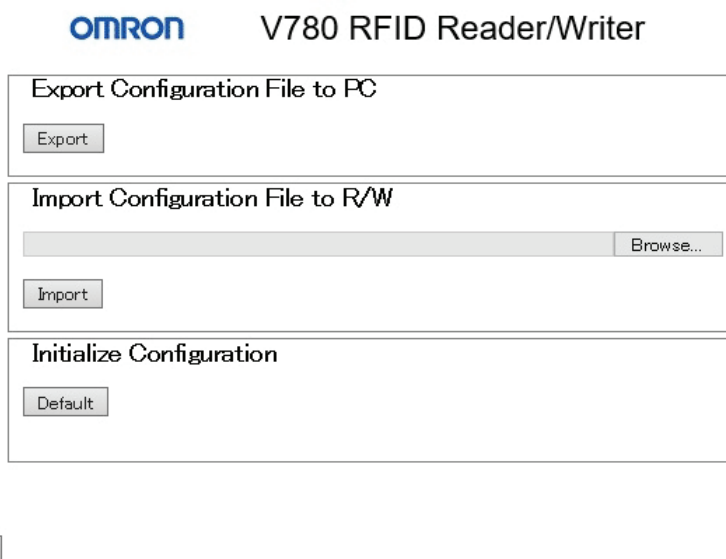

Item name	Description
Export Configuration File to PC	Saves a configuration file that contains the Reader/Writer settings on the computer.
Import Configuration File to R/W	Updates the settings in the Reader/Writer with the settings in a configuration file that you specify on the computer.
Initialize Configuration	Returns all of the settings in the Reader/Writer to the default settings.

Saving a Configuration File on the Computer

You can click the **Export** Button in the Export Configuration File to PC Area to save a configuration file (file name: conf.ini) that contains the configuration information from the Reader/Writer on the computer. The configuration file uses a normal INI file format.

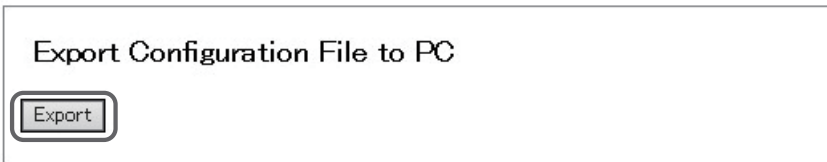

Click the **Export** Button. The following dialog box will be displayed. Click the **Save** Button.



The following Security Warning Dialog Box will be displayed. Click the **Allow** Button.

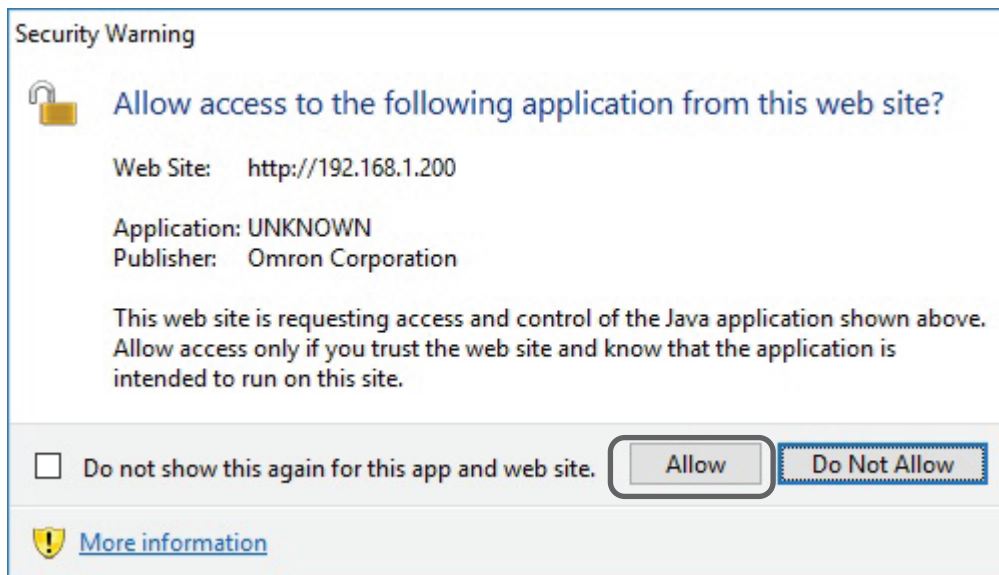

When the configuration file has been saved (file name: conf.ini), the following dialog box will be displayed. Click the **Open folder** Button to display the folder in which the configuration file was saved.

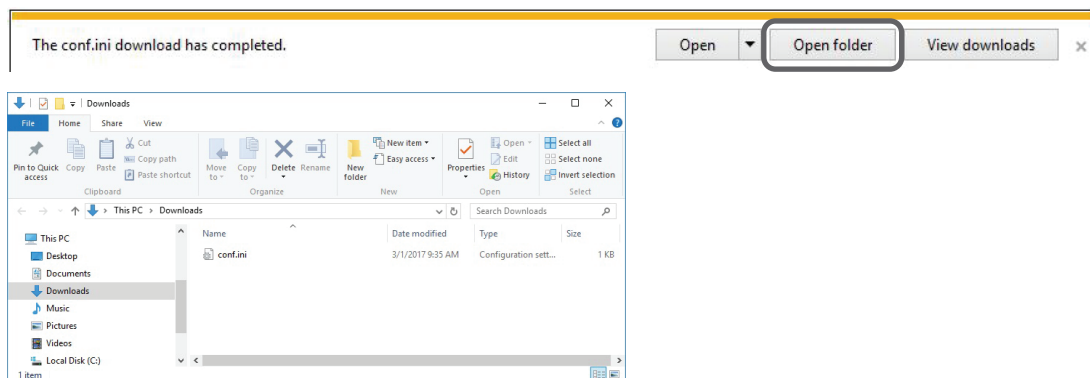

Loading a Configuration File to the Reader/Writer

You can change all of the configuration information in the Reader/Writer with the following procedure: Click the **Browse** Button in the Import Configuration File to R/W Area, select the configuration file to use to set up the Reader/Writer, and then click the **Import** Button.

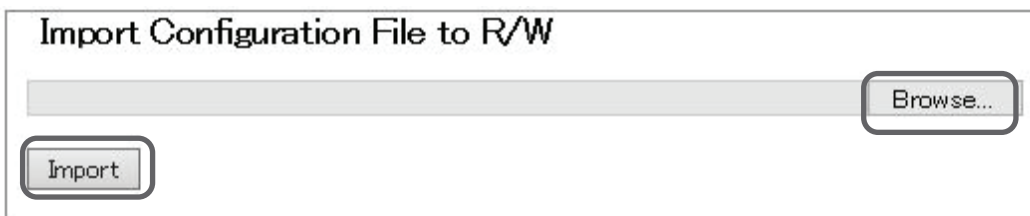

Click the **Browse** Button. A dialog box to select the configuration file will be displayed. Select the configuration file and then click the **Open** Button.

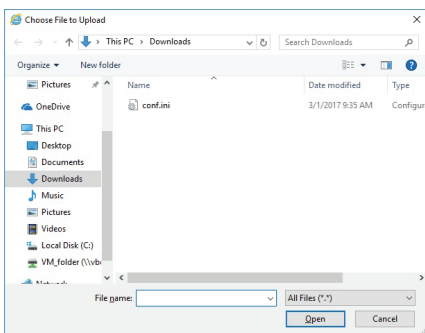

Click the **Import** Button. All of the configuration information in the Reader/Writer will be changed.



8-2-11 Configuration File

This section describes the format of the configuration file. The configuration file uses a normal INI file format.

- Any line that starts with a semicolon (;) is treated as a comment.
- Any line that starts with an opening bracket ([) is treated as a section declaration row. The row must also end in a closing bracket (]).
- Any row that does not start with either of the above two characters is an entry row.

Section and Entry Table

Section name	Entry name	Description	Default
NetworkSetting	IPAddressSetting Method	Gives the IP address setting method for the Reader/Writer. Specify a decimal value. 0000: Fixed setting 0001: Obtain from BOOTP server 0002: Get from BOOTP server as fixed settings	0000
	IPAddress	Gives the setting of the IP address of the Reader/Writer. It is given as four decimal numbers separated by periods.	192.168.1.200
	SubnetMask	Gives the setting of the subnet mask of the Reader/Writer. It is given as four decimal numbers separated by periods.	255.255.255.0
	GatewayAddress	Gives the setting of the default gateway of the Reader/Writer. It is given as four decimal numbers separated by periods.	192.168.1.254
	DeviceName	Gives the name of the Reader/Writer. It is given in up to 63 ASCII characters.	(Not set.)
	ModbusTCPPort ^{*1}	Gives the Modbus/TCP port. It is set to 502 or from 1024 to 65535 decimal.	502
	WebPort	Gives the Ethernet communications port number for the browser interface. It is set to 1024 to 65535 decimal.	7090
	WebPassword	Gives the login password for the browser interface. It is specified in up to 15 ASCII characters. "" (blank) is specified for no password.	(Not set.)
RFCommunication-Setting	RFCommunication Mode	Gives the RF communications mode setting. It is specified as a decimal value. 0: Once 1: Auto 2: Focus	0
	RFCommunication Speed	Gives the communications speed between the Reader/Writer and RF Tags. It is specified as a decimal value. 0: Auto speed 1: High speed 2: Normal speed	0
	RFCommunication Timeout	Gives the RF communications timeout time. It is specified as a decimal value.	250

Section name	Entry name	Description	Default
RFCommunication-Setting	WriteVerify	Gives the setting for write verification for write communications. Either “true” or “false” is specified. true: Verification used. false: Verification not used.	true
	RFCommunicationDiagnostics	Gives the enable/disable setting for RF communications diagnostics. It is set to true or false. true: Enable false: Disable	false
RFCommunication-AdvanceSetting	ReadTransmissionPower	Gives the transmission power setting for read RF communications commands. It is specified as a decimal value. 15 to 27: 15 to 27 dBm	27
	WriteTransmissionPower	Gives the transmission power setting for write RF communications commands. It is specified as a decimal value. 15 to 27: 15 to 27 dBm	27
	Channel	Gives the channel setting. It is specified as a decimal value. *1. You can specify the value depending on the model number. For details, refer to <i>Channel</i> on page 6-26 under 6-4-3 <i>RF Communications Conditions: Advanced Settings</i> on page 6-26.	0
	Gen2Session	Gives the setting of the Gen2 session. It is specified as a decimal value. 0 to 3: S0 to S3	0
	AccessPassword	Gives the access password for RF Tag communications. It is specified in eight hexadecimal digits. A setting of 00000000 is treated as no password setting.	00000000
	ContinuousTime	Gives the setting of the continuous transmission time. It is specified as a decimal value. *1. You can specify the value depending on the model number. For details, refer to <i>Transmission Time</i> on page 6-28 under 6-4-3 <i>RF Communications Conditions: Advanced Settings</i> on page 6-26.	*1. You can specify the value depending on the model number. For details, refer to <i>Transmission Time</i> on page 6-28 under 6-4-3 <i>RF Communications Conditions: Advanced Settings</i> on page 6-26.
	StopTime	Gives the setting of the stop time. It is specified as a decimal value. *1. You can specify the value depending on the model number. For details, refer to <i>Transmission Time</i> on page 6-28 under 6-4-3 <i>RF Communications Conditions: Advanced Settings</i> on page 6-26.	

Section name	Entry name	Description	Default
RFCommunication-AdvanceSetting	RSSIFilterEnable	Gives the enable/disable setting of the RSSI filter. It is set to true or false. true: Enable false: Disable	false
	RSSIFilterHighThreshold	Gives the setting of the high threshold for the RSSI filter. It is set to 0 or from -10 to -70 decimal.	0
	RSSIFilterLowThreshold	Gives the setting of the low threshold for the RSSI filter. It is set to 0 or from -10 to -70 decimal.	0
	RFTagSelectFilterEnable	Gives the enable/disable setting of the RF Tag selection filter. It is set to true or false. true: Enable false: Disable	false
	RFTagSelectFilterMemoryAddress1	Gives the memory address setting for the RF Tag selection filter. It is specified in four hexadecimal digits.	0000
	RFTagSelectFilterSize1	Gives the setting of the data length in words for the RF Tag selection filter. It is set to 0 to 16 decimal.	0
	RFTagSelectFilterVerificationData1	Gives the setting of the verification data for the RF Tag selection filter. It is specified in 64 hexadecimal digits (16 words).	00...00
DeviceSetting	LEDCustomNormal	Gives the custom indicator setting for a normal command (NORM). It is set to -1 (not lit) or from 1 to 7 (individual colors) decimal.	1 (green)
	LEDCustomError	Gives the custom indicator setting for a command error (ERROR). It is set to -1 (not lit) or from 1 to 7 (individual colors) decimal.	2 (red)
	LEDCustomWarning	Gives the custom indicator setting for unstable communications (WARNING). It is set to -1 (not lit) or from 1 to 7 (individual colors) decimal.	3 (yellow)

Section name	Entry name	Description	Default
Multi-ReaderWriter-Setting	Multi-ReaderWriter Mode	This is the Multi-Reader/Writer setting. It is given as a decimal value. 0: Disabled 1: Enabled (Communications range expansion mode)	0
	NumberOfSlave ReaderWriters	This is the number of connected slave Reader/Writers. It is given as a decimal value. 1 to 7	0
	SlaveReaderWriter1_IPAddress	This is the fixed IP address setting of slave Reader/Writer 1. It is given as four decimal numbers separated by periods.	0.0.0.0
	SlaveReaderWriter2_IPAddress	This is the fixed IP address setting of slave Reader/Writer 2. It is given as four decimal numbers separated by periods.	0.0.0.0
	SlaveReaderWriter3_IPAddress	This is the fixed IP address setting of slave Reader/Writer 3. It is given as four decimal numbers separated by periods.	0.0.0.0
	SlaveReaderWriter4_IPAddress	This is the fixed IP address setting of slave Reader/Writer 4. It is given as four decimal numbers separated by periods.	0.0.0.0
	SlaveReaderWriter5_IPAddress	This is the fixed IP address setting of slave Reader/Writer 5. It is given as four decimal numbers separated by periods.	0.0.0.0
	SlaveReaderWriter6_IPAddress	This is the fixed IP address setting of slave Reader/Writer 6. It is given as four decimal numbers separated by periods.	0.0.0.0
	SlaveReaderWriter7_IPAddress	This is the fixed IP address setting of slave Reader/Writer 7. It is given as four decimal numbers separated by periods.	0.0.0.0
	SlaveReaderWriter1_ReadTransmission Power	This is the transmission power setting for communications commands of the slave Reader/Writer 1 read system. It is given as a decimal value. 15 to 27: 15 to 27 dBm	27
	SlaveReaderWriter1_WriteTransmission Power	This is the transmission power setting for communications commands of the slave Reader/Writer 1 write system. It is given as a decimal value. 15 to 27: 15 to 27 dBm	27
	SlaveReaderWriter2_ReadTransmission Power	This is the transmission power setting for communications commands of the slave Reader/Writer 2 read system. It is given as a decimal value. 15 to 27: 15 to 27 dBm	27
	SlaveReaderWriter2_WriteTransmission Power	This is the transmission power setting for communications commands of the slave Reader/Writer 2 write system. It is given as a decimal value. 15 to 27: 15 to 27 dBm	27
	SlaveReaderWriter3_ReadTransmission Power	This is the transmission power setting for communications commands of the slave Reader/Writer 3 read system. It is given as a decimal value. 15 to 27: 15 to 27 dBm	27

Section name	Entry name	Description	Default
Multi-ReaderWriter-Setting ^{*1}	SlaveReaderWriter3_WriteTransmission Power	This is the transmission power setting for communications commands of the slave Reader/Writer 3 write system. It is given as a decimal value. 15 to 27: 15 to 27 dBm	27
	SlaveReaderWriter4_ReadTransmission Power	This is the transmission power setting for communications commands of the slave Reader/Writer 4 read system. It is given as a decimal value. 15 to 27: 15 to 27 dBm	27
	SlaveReaderWriter4_WriteTransmission Power	This is the transmission power setting for communications commands of the slave Reader/Writer 4 write system. It is given as a decimal value. 15 to 27: 15 to 27 dBm	27
	SlaveReaderWriter5_ReadTransmission Power	This is the transmission power setting for communications commands of the slave Reader/Writer 5 read system. It is given as a decimal value. 15 to 27: 15 to 27 dBm	27
	SlaveReaderWriter5_WriteTransmission Power	This is the transmission power setting for communications commands of the slave Reader/Writer 5 write system. It is given as a decimal value. 15 to 27: 15 to 27 dBm	27
	SlaveReaderWriter6_ReadTransmission Power	This is the transmission power setting for communications commands of the slave Reader/Writer 6 read system. It is given as a decimal value. 15 to 27: 15 to 27 dBm	27
	SlaveReaderWriter6_WriteTransmission Power	This is the transmission power setting for communications commands of the slave Reader/Writer 6 write system. It is given as a decimal value. 15 to 27: 15 to 27 dBm	27
	SlaveReaderWriter7_ReadTransmission Power	This is the transmission power setting for communications commands of the slave Reader/Writer 7 read system. It is given as a decimal value. 15 to 27: 15 to 27 dBm	27
	SlaveReaderWriter7_WriteTransmission Power	This is the transmission power setting for communications commands of the slave Reader/Writer 7 write system. It is given as a decimal value. 15 to 27: 15 to 27 dBm	27

*1. The slave reader / writer (V780-HMD68-ETN-□□-S) can not import/export “Multi-ReaderWriterSetting” and “ModbusTCPPort” of the setting file.

9

Troubleshooting

This section describes the types of errors that can occur for V780 Reader/Writers, how to check for errors, and how to correct errors.

9-1	Types of Errors	9-2
9-1-1	Errors Indicated on Operation Indicators	9-2
9-1-2	Errors Indicated with Error Codes	9-3
9-2	Error Tables	9-4
9-2-1	Command Errors	9-4
9-2-2	System Errors	9-6
9-2-3	WDT Errors	9-7
9-3	Errors and Countermeasures	9-8
9-3-1	Command Errors	9-8
9-3-2	RF Tag Communications Error	9-11
9-3-3	Minor Fault	9-15
9-3-4	Major Fault	9-18
9-3-5	WDT Error	9-18
9-4	How to deal with browser interface problems	9-19
9-4-1	When the Web browser screen is not displayed or the screen layout is strange	9-19

9-1 Types of Errors

The Reader/Writer indicates errors in the following ways.

- Errors are indicated on the operation indicators.
- Errors are indicated with error codes.

9-1-1 Errors Indicated on Operation Indicators

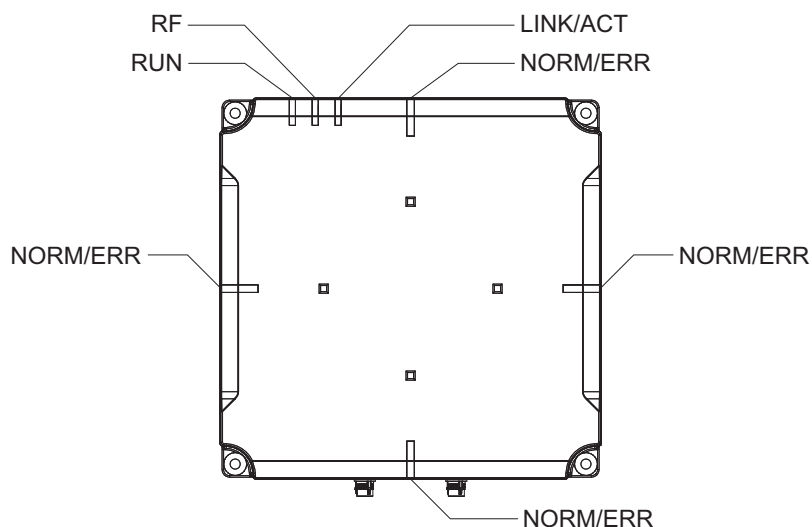

Reader/Writer operating status		Operation indicators		Execution of RF Tag communications	Communications connection to the host device
		RUN (green)	NORM/ERR (red)		
Running		Flashing at 0.1-s intervals	Not lit	Not possible	Not possible
Normal operation	Run Mode	Lit	Not lit	Possible	Possible
	Safe Mode	Flashing at 0.4-s intervals	Not lit	Not possible	Possible
	SLAVE Mode	Lit	Not lit	Not possible	Not possible
Errors for which the Reader/Writer will not operate	WDT error	Not lit	Lit	Not possible	Not possible
	IP address conflict	Flashing at 0.1-s intervals	Flashing irregularly twice	Not possible	Not possible
	BOOTP server connection error	Flashing at 0.1-s intervals	Flashing irregularly twice	Not possible	Not possible
Errors for which the Reader/Writer will operate	Command error	Lit	Flashes once	Possible	Possible
	RF Tag communications error	Lit	Flashes once	Possible	Possible
	Minor fault	Lit (See note.)	Flashing at 0.4-s intervals	Not possible	Possible
	Major fault	Lit (See note.)	Lit	Not possible	Possible

Note If these errors are detected during operation, the RUN indicator will flash at 0.4-s intervals.

9-1-2 Errors Indicated with Error Codes

Type		Description
Command errors	Command error	Errors related to command input or execution
	RF Tag communications error	Errors related to communications with RF Tags
System errors	Minor fault	Errors related to Reader/Writer settings or operation
	Major fault	Errors related to hardware

9-2 Error Tables

You can use the error code (4-digit hexadecimal value) to identify the error that was detected by the Reader/Writer.

Error codes are part of the information that is recorded in the command error log or system error log.

9-2-1 Command Errors

There are two types of command errors, command errors related to command input or execution and RF Tag communications errors related to communications with RF Tags. Command errors are recorded in the command error log when the response for command execution is returned.

Command Errors

Error name	Error code	Description
Frame length error	1001 hex	There was an error in the frame length of the received command.
Frame header error	1002 hex	There was an error in the frame header of the received command.
Unknown command error	1003 hex	A command that is not supported was received.
Command format error	1004 hex	There was an error in the format of the received command.
Command parameter error	1005 hex	There was an error in the parameters of the received command.
(Reserved)	---	
Command execution failure, busy	1011 hex	The Reader/Writer was executing another command and could not execute the received command.
Command execution failure (inappropriate operation mode)	1012 hex	The received command cannot be executed in the current operation mode of the Reader/Writer.
Command execution failure (inappropriate RF communications mode)	1013 hex	The received command cannot be executed in the current RF communications mode of the Reader/Writer.
(Reserved)	---	
Command execution failure, minor fault	1018 hex	There was a minor fault system error in the Reader/Writer and the Reader/Writer could not execute the received command.
(Reserved)	---	
Command execution failure, major fault	101F hex	There was a major fault system error in the Reader/Writer and the Reader/Writer could not execute the received command.
(Reserved)	---	
Command reply failure	1020 hex	A failure occurred in replying to a received command. (The command execution results cannot be returned to the host device.)

RF Tag Communications Errors

Error name	Error code	Description
RF Tag missing error ^{*1}	2001 hex	There is no RF Tag in the communications range.
RF Tag communications failed. ^{*1}	2002 hex	Communications with the RF Tag did not end normally.
(Reserved)	---	
RF Tag address error	2004 hex	The access address for the RF Tag is outside of the area supported by the target RF Tag.
RF Tag lock error	2005 hex	Access to an area that is locked in the RF Tag failed.
RF Tag verification error	2006 hex	Verification was performed for the results of writing data to the RF Tag, but inconsistencies were discovered.
(Reserved)	---	
RF Tag system error	2008 hex	The RF Tag returned an error response.
Password error	2009 hex	The access password does not match the RF Tag. ^{*2}
(Reserved)	---	
Communications error between Reader/Writers	200B hex	The master Reader/Writer will establish communications with the slave Reader/Writers during execution of the Multi-Reader/Writer function.
(Reserved)	---	
Communications canceled	2011 hex	Processing was canceled when a STOP command was received before an RF Tag was detected. (The contents of the RF Tag was not changed, even for a DATA WRITE command.)
Communications aborted	2012 hex	Processing was aborted when a STOP command was received during communications with an RF Tag.

*1. Due to the surrounding environment, the intended RF tag may not be readable if the transmission power output is overly strong.

*2. When the environment is unstable, this error can occur even if the access password is correct.

9-2-2 System Errors

There are mainly two types of system errors, minor faults related to Reader/Writer settings or operation and major faults related to hardware. System errors are recorded in the system error log when they are detected by Reader/Writer self-diagnostic processing.

Minor Faults

Error name	Error code	Description
Unfixed operating mode	8001 hex	The control signals that determine the operation mode of the Reader/Writer could not be read. If this error is detected, the Reader/Writer will start in Safe Mode.
Invalid network setting	8002 hex	A mistake was detected in the network settings stored in memory in the Reader/Writer. If this error is detected, the Reader/Writer will start in Safe Mode.
Invalid RF communications setting	8003 hex	A mistake was detected in the RF communications settings stored in memory in the Reader/Writer.
Incorrect device setting data	8004 hex	A mistake was detected in the device settings stored in memory in the Reader/Writer.
(Reserved)	---	
Invalid system error log data	800F hex	A mistake was detected in the system error log stored in memory in the Reader/Writer. When this error occurs, only one record of it is left in the error log.
(Reserved)	---	
IP address conflict	8011 hex	The same IP address as the Reader/Writer was detected on the same network.
BOOTP server connection error	8012 hex	Communications with the BOOTP server could not be established to get the IP address.
(Reserved)	---	
Multi-Reader/Writer cannot start	8021 hex	Startup of Multi-Reader/Writer function failed.

Major Faults

Error name	Error code	Description
System configuration error	F00* hex	A mistake was detected in the system program or system data stored in memory in the Reader/Writer.
(Reserved)	---	
Non-volatile memory access error	F01* hex	Reading/writing non-volatile memory in the Reader/Writer failed.
(Reserved)	---	
Hardware fault	F02* hex	A failure was detected in the hardware in the Reader/Writer.
(Reserved)	---	

9-2-3 WDT Errors

A WDT timer occurs when a system runaway causes the watchdog timer to time out.

If a WDT error is detected when the system runs out of control during operation, the RUN indicator will go out and the NORM/ERR indicators will light red. There is no error code for a WDT error and no record is recorded in the system error log.

Error name	Error code	Description
WDT error	---	A system runaway in the Reader/Writer was detected. This is a fatal error, so you must either restart or replace the Reader/Writer.

Refer to 9-1-1 *Errors Indicated on Operation Indicators* on page 9-2 and 3-1-2 *Operation Indicators at Startup* on page 3-3 for information on the operation indicators when a WDT error occurs.

9-3 Errors and Countermeasures

This section gives the errors detected by the Reader/Writer and corresponding countermeasures. The items used in the following tables are described below.

Error name	The name of the error.	Error code	The value of the error code (four hexadecimal digits).
Description	A description of the error.		
Detection timing	When the error is detected.	Recovery method	How to recover from the error.
Log category	The type of log the error is recorded in.		
Additional information 1	A description of the additional information 1 that is recorded.	Additional information 2	A description of the additional information 2 that is recorded.
Probable cause	A description of the probable cause of the error.		
Workaround	A description of countermeasures for the probable cause of the error.		
Precautions/Remarks	Precautions, restrictions, and other supplemental information.		

9-3-1 Command Errors

Error name	Frame length error	Error code	1001 hex
Description	There was an error in the frame length of the received command data.		
Detection timing	At command reception	Recovery method	None
Log category	Command error log		
Additional information 1	Cause code	Additional information 2	None
Probable cause	(1) Cause code: 00000001 hex The command frame length exceeded the upper limit (255 bytes) (FC03/FC16). (2) Cause code: 00000002 hex The command frame length exceeded the upper limit (4,352 bytes) (FC100). (3) Cause code: 00000003 hex The command frame length does not agree with the value given for the field length.		
Workaround	Check the command frame length and send the command again.		
Precautions/Remarks	None		

Error name	Frame header error	Error code	1002 hex
Description	There was an error in the frame header of the received command.		
Detection timing	At command reception	Recovery method	None
Log category	Command error log		
Additional information 1	Cause code	Additional information 2	None
Probable cause	(1) Cause code: 00000001 hex The protocol ID in the frame header was not 0000 hex. (2) Cause code: 00000002 hex The unit ID in the frame header was not FF hex.		
Workaround	Check the command frame contents and send the command again.		
Precautions/Remarks	None		

Error name	Unknown command error	Error code	1003 hex
Description	A command that is not supported was received.		
Detection timing	At command reception	Recovery method	None
Log category	Command error log		
Additional information 1	Cause code	Additional information 2	None
Probable cause	<p>(1) Cause code: 00000001 hex The value of the function code is incorrect.</p> <p>(2) Cause code: 00000002 hex The function code and register address combination is not correct (FC03/FC16).</p> <p>(3) Cause code: 00000003 hex The function code and subfunction code combination is not correct (FC100).</p>		
Workaround	Check the command frame contents and send the command again.		
Precautions/Remarks	None		

Error name	Command format error	Error code	1004 hex
Description	There was an error in the format of the received command.		
Detection timing	At command reception	Recovery method	None
Log category	Command error log		
Additional information 1	Cause code	Additional information 2	None
Probable cause	<p>(1) Cause code: 00000001 hex The register address and word count fields are missing (FC03).</p> <p>(2) Cause code: 00000002 hex The register address field and word count or byte count field are missing (FC16).</p> <p>(3) Cause code: 00000003 hex The value of the word count is not correct for the register address (FC03/FC16).</p> <p>(4) Cause code: 00000004 hex The values of the word count and byte count do not agree with the register data size (FC16).</p>		
Workaround	Check the command frame contents and send the command again.		
Precautions/Remarks	None		

Error name	Command parameter error	Error code	1005 hex
Description	There was an error in the parameters of the received command.		
Detection timing	At command reception	Recovery method	None
Log category	Command error log		
Additional information 1	None	Additional information 2	None
Probable cause	<p>(1) The value of the holding register data is not correct (FC16).</p> <p>(2) The value of the expanded command parameter is not correct (FC100).</p>		
Workaround	Check the command frame contents and send the command again.		
Precautions/Remarks	None		

Error name	Command execution failure, busy	Error code	1011 hex
Description	The Reader/Writer was executing another command and could not execute the received command.		
Detection timing	At command execution	Recovery method	None
Log category	Command error log		
Additional information 1	None	Additional information 2	None
Probable cause	(1) An RF communications command was received during a setting change. (2) A setting command was received during execution of an RF communications command.		
Workaround	Check the operation status of the Reader/Writer and send the command again.		
Precautions/Remarks	None		

Error name	Command execution failure (inappropriate operation mode)	Error code	1012 hex
Description	The received command cannot be executed in the current operation mode of the Reader/Writer.		
Detection timing	At command execution	Recovery method	None
Log category	Command error log		
Additional information 1	None	Additional information 2	None
Probable cause	An RF communications command was received during operation in Safe Mode.		
Workaround	Check the operation mode of the Reader/Writer and send the command again.		
Precautions/Remarks	None		

Error name	Command execution failure (inappropriate RF communications mode)	Error code	1013 hex
Description	The received command cannot be executed in the current RF communications mode of the Reader/Writer.		
Detection timing	At command execution	Recovery method	None
Log category	Command error log		
Additional information 1	None	Additional information 2	None
Probable cause	A multiaccess RF communications command was received in Focus Mode.		
Workaround	Check the RF communications mode of the Reader/Writer and send the command again.		
Precautions/Remarks	None		

Error name	Command execution failure, minor fault	Error code	1018 hex
Description	There was a system error (minor fault) in the Reader/Writer and the Reader/Writer could not execute the received command.		
Detection timing	At command execution	Recovery method	Restart the Reader/Writer.
Log category	Command error log		
Additional information 1	Error code*	Additional information 2	None
Probable cause	Refer to the error information for a minor fault in additional information 1.		
Workaround			
Precautions/Remarks	None		

*1. This provides information on the current minor fault.

Error name	Command execution failure, major fault	Error code	101F hex
Description	There was a system error (major fault) in the Reader/Writer and the Reader/Writer could not execute the received command.		
Detection timing	At command execution	Recovery method	Restart the Reader/Writer.
Log category	Command error log		
Additional information 1	Error code*	Additional information 2	None
Probable cause	Refer to the error information for a major fault in additional information 1.		
Workaround			
Precautions/Remarks	None		

*1. This provides information on the current major fault.

Error name	Command reply failure	Error code	1020 hex
Description	A failure occurred in replying to a received command.		
Detection timing	At response transmission	Recovery method	None
Log category	Command error log		
Additional information 1	None	Additional information 2	None
Probable cause	(1) The Ethernet cable connected to the communications connector on the Reader/Writer is disconnected. (2) The connection between the Reader/Writer and communicating host device is broken.		
Workaround	Make sure that the Reader/Writer's Ethernet communications cable is connected correctly. Check the operating status of the host device system.		
Precautions/Remarks	If the LINK/ACT operation indicator on the Reader/Writer is not lit, the Reader/Writer has not joined the network.		

9-3-2 RF Tag Communications Error

Error name	RF Tag missing error	Error code	2001 hex
Description	An RF Tag could not be detected in the communications range.		
Detection timing	At RF communications execution	Recovery method	None
Log category	Command error log		
Additional information 1	None	Additional information 2	None
Probable cause	(1) There is no RF Tag in the communications range of the Reader/Writer. (2) The ambient environment is affecting operation (radio wave interference or surrounding metal). (3) Collision occurred for responses from more than one RF Tag. (4) There is no RF Tag that meets the filter conditions in the RF communications settings in the communications range of the Reader/Writer. (5) The response from the RF tag is weak because transmission power tuning is not appropriate.		
Workaround	Make sure there is an RF Tag in the communications range. Adjust the execution timing of the command to start communications with the RF Tag. Prepare an RF Tag that meets the filter conditions or revise the conditions. Increase or reduce transmission power tuning.		
Precautions/Remarks			

Error name	RF Tag communications failed	Error code	2002 hex
Description	Communications with the RF Tag did not end normally.		
Detection timing	At RF communications execution	Recovery method	None
Log category	Command error log		
Additional information 1	Manufacturer analysis code 1	Additional information 2	Manufacturer analysis code 2
Probable cause	<p>(1) There is no RF Tag in the stable communications range of the RF Tag.</p> <p>(2) The ambient environment is affecting operation (radio wave interference or surrounding metal).</p> <p>(3) Collision occurred for responses from more than one RF Tag.</p> <p>(4) The response from the RF tag is weak because transmission power tuning is not appropriate.</p>		
Workaround	<p>Make sure there is an RF Tag in the stable communications range.</p> <p>Adjust the execution timing of the command to start communications with the RF Tag.</p> <p>Increase or reduce transmission power tuning.</p>		
Precautions/Remarks			

Error name	RF Tag address error	Error code	2004 hex
Description	The access address for the RF Tag is outside of the area supported by the target RF Tag.		
Detection timing	At RF communications execution	Recovery method	None
Log category	Command error log		
Additional information 1	None	Additional information 2	None
Probable cause	<p>(1) The start address to the RF Tag access area specified in the command exceeds the memory area of the RF Tag.</p> <p>(2) The size the RF Tag access area specified in the command exceeds the memory area of the RF Tag.</p>		
Workaround	Make sure that the RF Tag access area specified in the command matches the memory area in the RF Tag that is being used.		
Precautions/Remarks			

Error name	RF Tag lock error	Error code	2005 hex
Description	Access to an area that is locked in the RF Tag failed.		
Detection timing	At RF communications execution	Recovery method	None
Log category	Command error log		
Additional information 1	None	Additional information 2	None
Probable cause	<p>(1) The RF Tag is locked and the access password is not set in the Reader/Writer.</p> <p>(2) The RF Tag is locked and the access password does not match the access password set in the Reader/Writer.</p>		
Workaround	<p>Check the access password set in the RF Tag.</p> <p>Set the access password from the RF Tag in the Reader/Writer and execute the command again.</p>		
Precautions/Remarks			

Error name	RF Tag verification error	Error code	2006 hex
Description	Verification was performed for the results of writing data to the RF Tag, but inconsistencies were discovered.		
Detection timing	At RF communications execution	Recovery method	None
Log category	Command error log		
Additional information 1	None	Additional information 2	None
Probable cause	(1) There is no RF Tag in the stable communications range of the RF Tag. (2) The ambient environment is affecting operation (radio wave interference or surrounding metal). (3) Collision occurred for responses from more than one RF Tag.		
Workaround	Execute the command again. If the same error still occurs, try the following measures. Make sure there is an RF Tag in the stable communications range. Adjust the execution timing of the command to start communications with the RF Tag.		
Precautions/Remarks			

Error name	RF Tag system error	Error code	2008 hex
Description	The RF Tag returned an error response.		
Detection timing	At RF communications execution	Recovery method	None
Log category	Command error log		
Additional information 1	Manufacturer analysis code	Additional information 2	Manufacturer analysis code
Probable cause	(1) The RF Tag does not support the RF communications protocol of the Reader/Writer (ISO-18000-6C (Gen2)).		
Log category	(2) The RF Tag is faulty.		
Workaround	Consult with your OMRON representative concerning RF Tags that can communicate with the Reader/Writer. Replace the RF Tags with RF Tags that can communicate with the Reader/Writer.		
Precautions/Remarks			

Error name	Password error	Error code	2009 hex
Description	The access password does not match the RF Tag.*		
Detection timing	At RF communications execution	Recovery method	None
Log category	Command error log		
Additional information 1	None	Additional information 2	None
Probable cause	The access code in the RF Tag and the access code set in the Reader/Writer do not agree.		
Workaround	Check the access password set in the RF Tag.		
Precautions/Remarks			

*1. When the environment is unstable, this error can occur even if the access password is correct.

Error name	Communications error between Reader/Writers	Error code	200B hex
Description	The master Reader/Writer will establish communications with the slave Reader/Writers during execution of the Multi-Reader/Writer function.		
Detection timing	At RF communications execution	Recovery method	None
Log category	Command error log		
Additional information 1	Reader/writer number (slave Reader/Writer)	Additional information 2	None
Probable cause	(1) Slave Reader/Writer does not operate normally. (2) Slave Reader/Writer is not correctly connected to the network.		
Workaround	(1) Check that the slave Reader/Writer does operates normally. (2) confirm that the master Reader/Writer unit is connected to a network capable of communications.		
Precautions/Remarks			

Error name	Communications canceled	Error code	2011 hex
Description	Processing was canceled when a STOP command was received before an RF Tag was detected.		
Detection timing	At RF communications execution	Recovery method	None
Log category	Command error log		
Additional information 1	None	Additional information 2	None
Probable cause	(1) The host device requested execution of the STOP command.		
Workaround	Check the reason the host device sent the STOP command.		
Precautions/Remarks	The contents of the RF Tag was not changed, even for a DATA WRITE command.		

Error name	Communications aborted	Error code	2012 hex
Description	Processing was aborted when a STOP command was received during communications with an RF Tag.		
Detection timing	At RF communications execution	Recovery method	None
Log category	Command error log		
Additional information 1	None	Additional information 2	None
Probable cause	(1) The host device requested execution of the STOP command.		
Workaround	Check the reason the host device sent the STOP command. The contents of the RF Tag may have been rewritten during processing. Check operation.		
Precautions/Remarks	The contents of the RF Tag was not changed, even for a DATA WRITE command.		

9-3-3 Minor Fault

Error name	Unfixed operating mode	Error code	8001 hex
Description	The control signals that determine the operation mode of the Reader/Writer could not be read.		
Detection timing	At startup	Recovery method	Reboot.
Log category	System error log		
Additional information 1	None	Additional information 2	None
Probable cause	(1) The connections of the control signals on the power supply connector to the Reader/Writer are not stable. (2) Operation is being affected by ambient noise.		
Workaround	(1) Check the connection of the control signal line to the 24 VDC terminal on the power supply. (2) Check for sources of noise around the power supply cable.		
Precautions/Remarks	If this error is detected, the Reader/Writer will start in Safe Mode.		

Error name	Invalid network setting	Error code	8002 hex
Description	A mistake was detected in the network settings stored in memory in the Reader/Writer.		
Detection timing	At startup	Recovery method	Reboot.
Log category	System error log		
Additional information 1	None	Additional information 2	None
Probable cause	(1) There is data corruption in the memory of the Reader/Writer. (2) The memory in the Reader/Writer has reached its service life or is faulty.		
Workaround	Initialize the network settings. (Use the INITIALIZE command or initialize the settings from the Web Browser Interface.)		
Precautions/Remarks	If this error is detected, the Reader/Writer will start in Safe Mode.		

Error name	Invalid RF communications setting	Error code	8003 hex
Description	A mistake was detected in the RF communications settings stored in memory in the Reader/Writer.		
Detection timing	At startup	Recovery method	Reboot.
Log category	System error log		
Additional information 1	0001 hex: Basic settings 0002 hex: Advanced settings	Additional information 2	None
Probable cause	(1) There is data corruption in the memory of the Reader/Writer. (2) Memory in the Reader/Writer has reached its service life or is faulty.		
Workaround	Initialize the RF communications settings. (Use the INITIALIZE command or initialize the settings from the Web Browser Interface.)		
Precautions/Remarks			

Error name	Incorrect device setting data	Error code	8004 hex
Description	A mistake was detected in the device settings stored in memory in the Reader/Writer.		
Detection timing	At startup	Recovery method	Reboot.
Log category	System error log		
Additional information 1	0001 hex: LED custom settings 0002 hex: Multi-Reader/Writer setting	Additional information 2	None
Probable cause	(1) There is data corruption in the memory of the Reader/Writer. (2) Memory in the Reader/Writer has reached its service life or is faulty.		
Workaround	Initialize the device settings. (Use the INITIALIZE command or initialize the settings from the Web Browser Interface.)		
Precautions/Remarks			

Error name	Invalid system error log data	Error code	800F hex
Description	A mistake was detected in the system error log stored in memory in the Reader/Writer.		
Detection timing	At startup	Recovery method	Reboot.
Log category	System error log		
Additional information 1	None	Additional information 2	None
Probable cause	(1) There is data corruption in the memory of the Reader/Writer. (2) Memory in the Reader/Writer has reached its service life or is faulty.		
Workaround	Delete the system error log. (Use the command to delete the system error log or delete it from the Web Browser Interface.)		
Precautions/Remarks	When this error occurs, only one record of it is left in the error log.		

Error name	IP address duplication error	Error code	8011 hex
Description	The same IP address as the Reader/Writer was detected on the same network.		
Detection timing	At startup	Recovery method	Reboot.
Log category	System error log		
Additional information 1	None	Additional information 2	None
Probable cause	There is another device on the same network as the Reader/Writer that has the same IP address.		
Workaround	Remove the Reader/Writer from the network, correct the IP addresses, and add the Reader/Writer to the network.		
Precautions/Remarks	Communications with the host device are not possible when this error occurs. Use the NORM/ERR indicators on the Reader/Writer to confirm this error. (The NORM/ERR indicators will flash irregularly twice.)		

Error name	BOOTP server connection error	Error code	8012 hex
Description	Communications with the BOOTP server could not be established to get the IP address.		
Detection timing	At startup	Recovery method	Reboot.
Log category	System error log		
Additional information 1	None	Additional information 2	None
Probable cause	(1) There is no BOOTP server on the same network as the Reader/Writer. (2) There are no settings for the Reader/Writer (MAC address and IP address) in the BOOTP server.		
Workaround	(1) Place a BOOTP server on the same network as the Reader/Writer. (2) Set the MAC address and IP address of the Reader/Writer in the BOOTP server.		
Precautions/Remarks	Communications with the host device is not possible when this error occurs. Use the NORM/ERR indicators on the Reader/Writer to confirm this error. (The NORM/ERR indicators will flash irregularly twice.)		

Error name	Multi-Reader/Writer cannot start	Error code	8021 hex
Description	Startup of Multi-Reader/Writer function failed.		
Detection timing	At startup	Recovery method	Reboot.
Log category	System error log		
Additional information 1	Cause code	Additional information 2	None
Probable cause	(1) [Cause code 00000001 hex: Incorrect mode] The Multi-Reader/Writer mode and communications mode combination is incorrect. (2) [Cause code 00000002 hex: IP address duplication] The IP address of the master Reader/Writer and a slave reader/writer are duplicated. (3) [Cause code 00000003 hex: Model mismatch] Communications are impossible due to a model mismatch of the master Reader/Writer and slave reader/writer. (4) [Cause code 00000004 hex: Version mismatch] Communications are impossible due to a version mismatch of the master Reader/Writer and slave reader/writer.		
Workaround	(1) Review the combination of the Multi-Reader/Writer mode and communications mode settings. (2) Review the IP address settings of the master Reader/Writer and a slave Reader/Writers. (3) Replace with a slave Reader/Writer matching the model of the master reader/writer. (4) Replace with a slave Reader/Writer matching the version of the master reader/writer.		
Precautions/Remarks			

9-3-4 Major Fault

Error name	System configuration error	Error code	F00* hex
Description	A mistake was detected in the system program or system data stored in memory in the Reader/Writer.		
Detection timing	At startup	Recovery method	Reboot.
Log category	System error log		
Additional information 1	None	Additional information 2	None
Probable cause	Memory inside the Reader/Writer is faulty.		
Workaround	If this error continues to occur even if you restart the Reader/Writer, replace the Reader/Writer.		
Precautions/Remarks	If this error is detected, the Reader/Writer will start in Safe Mode.		

Error name	Non-volatile memory access error	Error code	F01* hex
Description	Reading/writing non-volatile memory in the Reader/Writer failed.		
Detection timing	At change to settings	Recovery method	Reboot.
Log category	System error log		
Additional information 1	None	Additional information 2	None
Probable cause	Memory inside the Reader/Writer is faulty.		
Workaround	If this occurs continues to occur even if you restart the Reader/Writer, replace the Reader/Writer.		
Precautions/Remarks			

Error name	Hardware fault	Error code	F02* hex
Description	A failure was detected in the hardware in the Reader/Writer.		
Detection timing	At RF communications execution	Recovery method	Reboot.
Log category	System error log		
Additional information 1	None	Additional information 2	None
Probable cause	The IC or antenna in the Reader/Writer is faulty.		
Workaround	If this occurs continues to occur even if you restart the Reader/Writer, replace the Reader/Writer.		
Precautions/Remarks			

9-3-5 WDT Error

Error name	WDT error	Error code	None
Description	A watchdog timer timeout that resulted from CPU runaway in the Reader/Writer was detected.		
Detection timing	During operation	Recovery method	Reboot.
Log category	None		
Probable cause	A hardware failure or temporary data corruption caused the CPU runaway.		
Workaround	If this occurs continues to occur even if you restart the Reader/Writer, replace the Reader/Writer.		
Precautions/Remarks	A WDT error is not recorded in the command error log or system error log.		

9-4 How to deal with browser interface problems

9-4-1 When the Web browser screen is not displayed or the screen layout is strange

When the Web browser screen is not displayed or the screen layout is strange.

Please reload. If the problem persists even after reloading, follow the procedure below to delete the temporary Internet file and then display it again.



Additional Information

Using Reader/Writer earlier than firmware Ver.4.00, please refer to *Cannot Display the Web Browser Operation Window* on page A-31 in *Section A Appendices*

Google Chrome

(1) Open the settings from "Google chrome settings" at the top right of the screen.

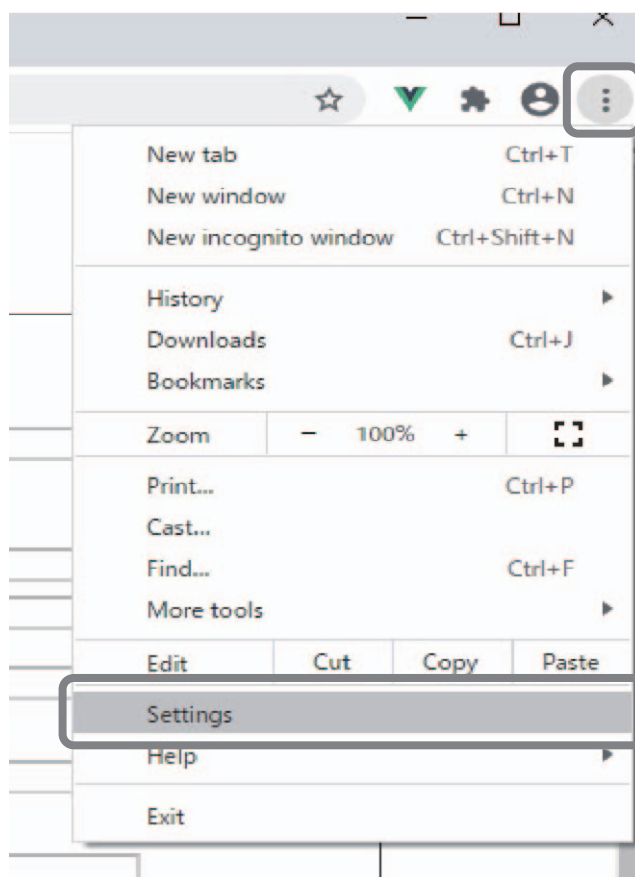

(2) Select Clear browsing data in the privacy and security section.

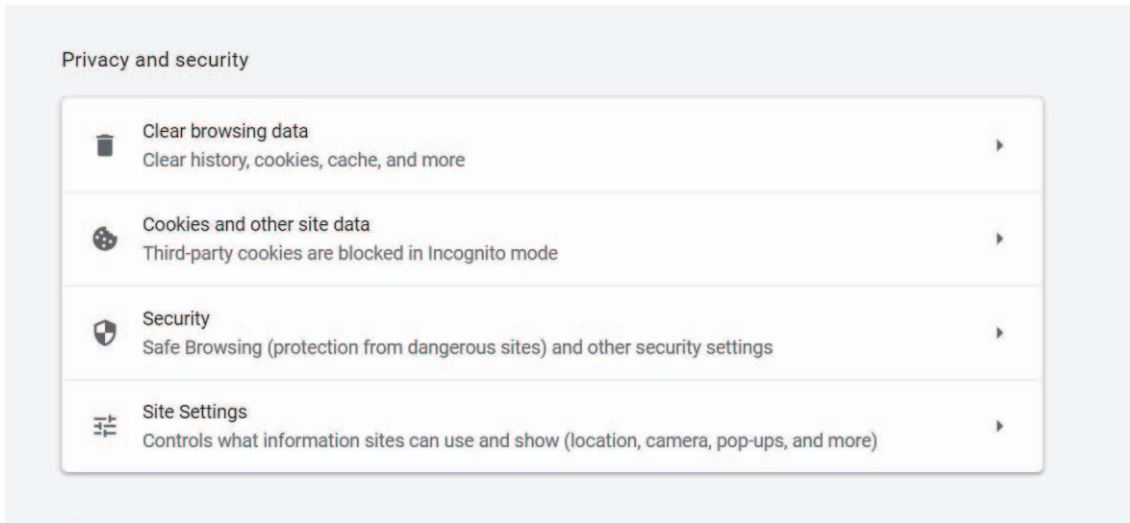

(3) Time range selects all time. Check cached images and files and select clear data.

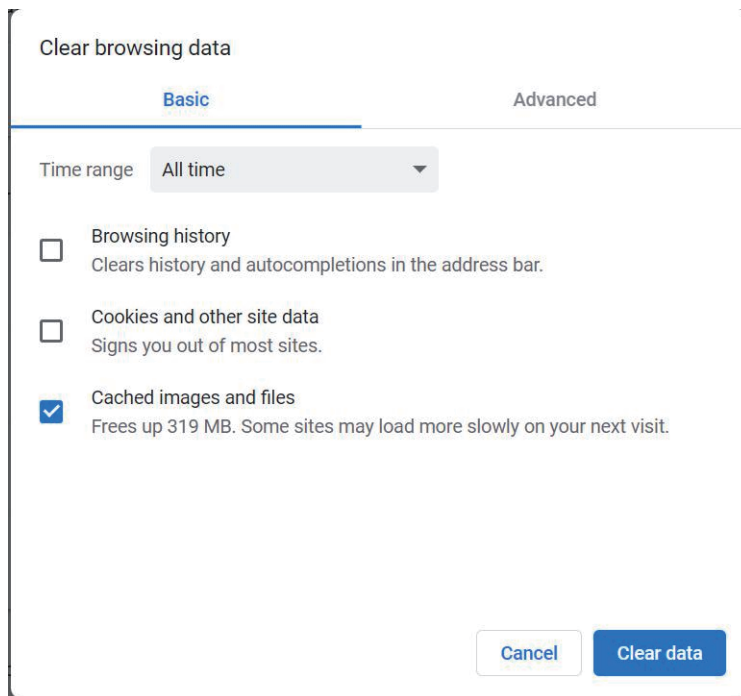

Internet explorer11

(1) Click the Tools menu and select Internet Options.

Click the delete... button in the Browsing History section of the General tab.

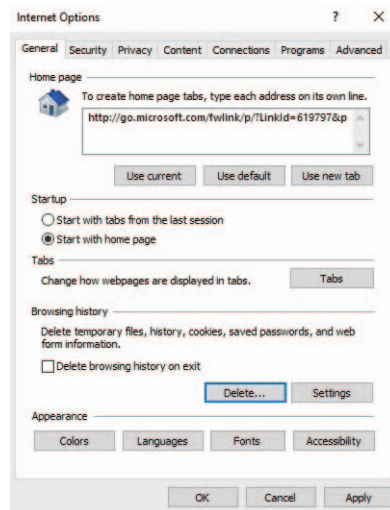

(2) Check “Temporary Internet files and website files” and click Delete.

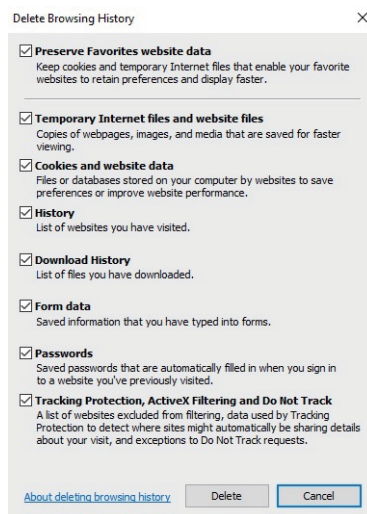

Microsoft Edge

(1) Click the three points in the upper right and click “Settings”.

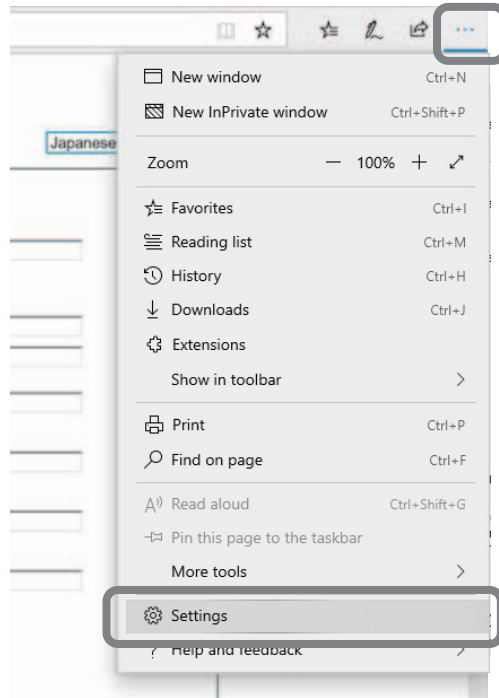

(2) Click “choose what to clear” in the “Privacy & Security” tab.

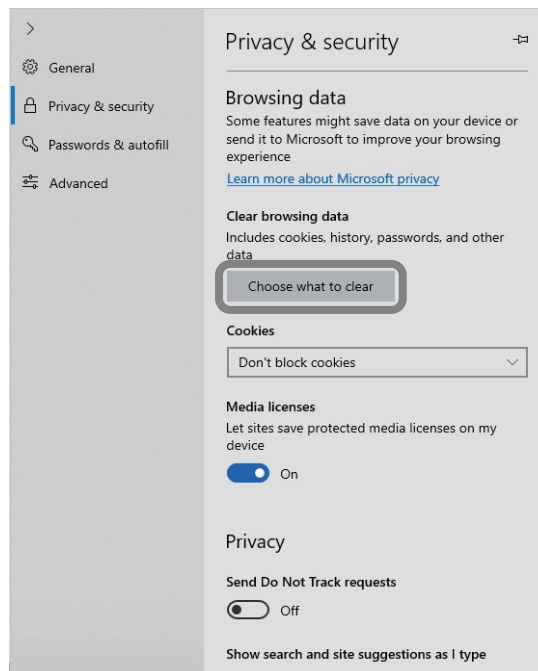

(3) Check “Cached data and files” and click Clear.

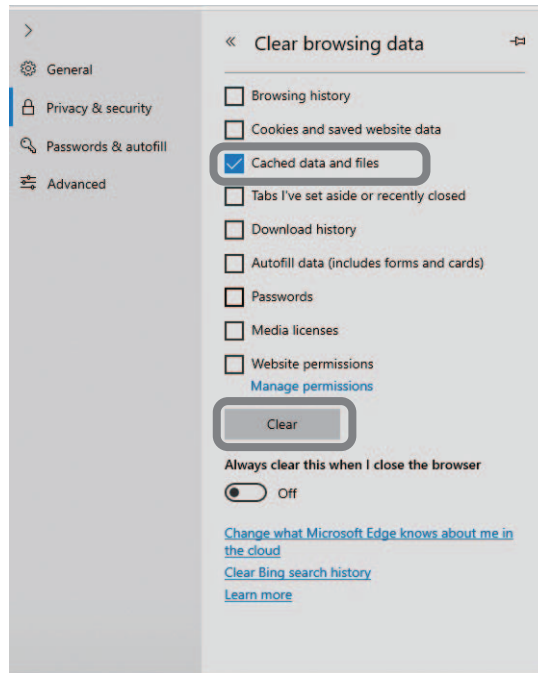

10

Maintenance and Inspection

This section describes maintenance and inspections for a V780 Reader/Writer.

10-1 Maintenance and Inspection	10-2
--	-------------

10-1 Maintenance and Inspection

The Reader/Writer must be inspected on a daily or periodic basis so that the functions remain in good condition.

The Reader/Writer consists of semiconductors that last almost indefinitely. The following malfunctions, however, may result due to the operating environment and conditions.

- (1) Element deterioration due to overvoltage or overcurrent.
- (2) Element deterioration due to continuous stress caused by high ambient temperature.
- (3) Connector contact faults or insulation deterioration due to humidity and dust.
- (4) Connector contact faults or element corrosion due to corrosive gas.

Inspection Items

No.	Inspection item	Details	Criteria	Remarks
1	Supply voltage fluctuation	(1) Check that the supply voltage fluctuation at the power supply terminal block is within the permissible range.	Within supply voltage specified range	Multimeter
		(2) Check that there are no frequent instantaneous power failures or radical voltage fluctuations.	Within permissible voltage fluctuation range	Power supply analyzer
2	Ambient environment			Maximum and minimum thermometer Hygrometer
	(A) Temperature	(A) Within the specified range	(A) -10 to 55°C	
	(B) Humidity	(B) Within the specified range	(B) 25% to 85%	
	(C) Vibration and shock	(C) Influence of vibration or shock from machines	(C) Within the specified range	
	(D) Dust	(D) Make sure that the Reader/Writer is free of accumulated dust and foreign particles.	(D) Must not be present.	
(E) Corrosive gas	(E) Check that no metal part of the system is discolored or corroded.	(E) Must not be present.		

No.	Inspection item	Details	Criteria	Remarks
3	Panel condition (A) Ventilation	(A) Check that the system is ventilated properly with natural ventilation, forced ventilation, or cooling air.	(A) The interior temperature must be within a range between -10 and 55°C with proper ventilation.	---
	(B) Damage to packing for any enclosing structure	(B) Make sure that the panel packing is properly attached with no damage.	(B) The packing must have no damage.	
4	Mounting condition	(1) Make sure that the Reader/Writer is securely mounted.	No loose screws	---
		(2) Make sure that each connector is fully inserted.	Each connector must be locked or securely tightened with screws.	---
		(3) Make sure that no wire is broken or nearly broken.	Must be no wire that is broken or nearly broken.	---

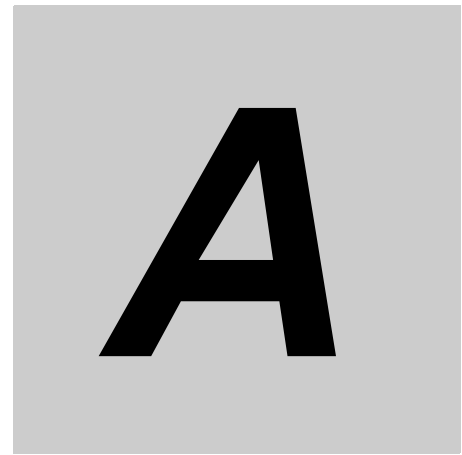

Appendices

The appendices provide various specifications related to communications with RF Tags and other supplemental information.

A-1 Licensing Procedures of Premises Radio Station	A-2
A-2 RF Tag Communications Times (For reference only)	A-4
A-3 RF Tag Memory Map	A-17
A-4 Communications Range Diagram, Reception Level Diagram (Reference Only)	A-18
A-5 Mutual Interference of Reader/Writers (Reference Only)	A-25
A-6 Chemical Resistance of the Reader/Writers	A-29
A-7 For customers using Reader/Writer earlier than firmware Ver.4.00.	A-30

A-1 Licensing Procedures of Premises Radio Station

V780-HMD68-ETN-JP/V780-HMD68-ETN-JP-S is a wireless facility of premises radio station to differentiate moving object using the 920-MHz band. The licensing procedures of the premises radio station must be performed before use. Be sure to perform the licensing procedures before use.

Introduction

As for the licensing procedures of the premises radio station, check the information regarding the latest procedures, and the documents necessary for the procedures on the Website of the Regional Bureau of Telecommunications.

The licensing procedures involve the submission of an application for a license at the local Regional Bureau of Telecommunications. A Regional Bureau of Telecommunications falls under the jurisdiction of each district. Please confirm your Regional Bureau of Telecommunications to perform the procedures.

For details on the Regional Bureau of Telecommunications in each district where you can perform the licensing procedures, refer to the Radio Use Website of the Ministry of Internal Affairs and Communications (<http://www.tele.soumu.go.jp/e/ref/material/commtab1/index.htm>).

Example) For the Kanto area (Ibaraki, Tochigi, Gunma, Saitama, Chiba, Tokyo, Kanagawa and Yamanashi)
 Contact the Kanto Bureau of Telecommunications (Website URL: <http://www.soumu.go.jp/soutsu/kanto/>).

For details on the licensing procedures system, refer to the Radio Use Website of the Ministry of Internal Affairs and Communications (<http://www.tele.soumu.go.jp/e/adm/proc/type/index.htm>).

The URL described above is effective as of July 2019.

Flow of Licensing Procedures (Overview)

The licensing procedures involve the submission of an application for a license in order to set up a radio station. When an application for a license is submitted, a license is issued. Once the license is received, the procedures are complete.

The flow of the licensing procedures is shown below.

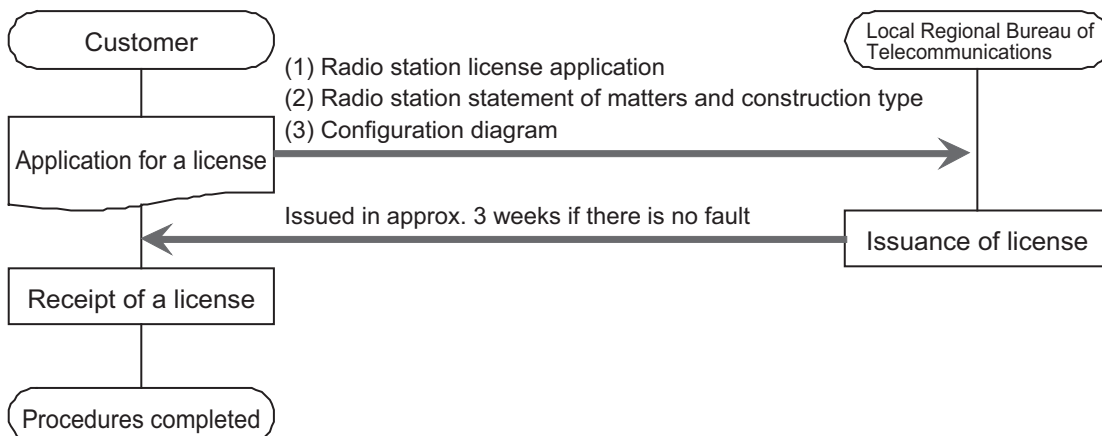

- * Please enclose a self-addressed return envelope for receipt of your license when applying for a license.
- * The license is effective for a period of 5 years (you will have to apply again for a license after 5 years.)
- * In case of any changes in the license contents or establishment report contents, you will have to perform change procedures.
- * If the license is no longer in use, please submit a discard report.
- * If there are any changes in the contact address, or the address for sending the radio use charges payment notice, or any changes in the station location, you will have to perform change procedures. You are requested to do the needful.

A-2 RF Tag Communications Times (For reference only)

The RF communications time is the time from when the host device sends a communications command to the Reader/Writer until it receives a response. The communications time differs depending on the radio regulations of each country, or the settings of the RF communications command and RF communications speed. In actual usage, the communications time may change under the influence of the installation environment, system conditions, type of RF Tags, and other factors. Perform sufficient testing in advance.



Precautions for Correct Use

If you enable communications diagnostics, the communications times will be increased by up to 100 ms.

Measurement Conditions

Measurement environment	Radio wave darkroom	
RF Tag	V780-A-JIME-Z3BLI-10 (made by Toppan Forms Co., Ltd.)* ¹	
Communications distance	Fixed at 0.5 m (between Reader/Writer and RF Tag)	
Transmission power	27 dBm	
RF communications speed	Given below.	
Communications command	Given below.	
Communications distance	Fixed at 0.5 m (between Reader/Writer and RF Tag)	Fixed at 1.8 m (between Reader/Writer and RF Tag)
		1 to 64 sheets

*1. The RF Tag was mounted to a V780-A-TA-133-10 Attachment.



Precautions for Correct Use

With multiaccess communications, collisions occur between communications with multiple RF Tags. Therefore, the communications time varies more than with single-access communications. The communications time also varies with the RF Tags that are used, the orientation of the RF Tags, and the ambient environment. Therefore, the communications times in the above graphs are strictly for reference only. Use them only as reference values for determining communications timeout times in the actual environment.

V780-HMD68-ETN-JP/V780-HMD68-ETN-JP-S

● ID READ (Single-access)

During 6-word (96bit) data readout from the UII (EPC) area

RF communications speed	Communications time
High speed	15 ms
Normal speed	27 ms

Single-access		
	RF communications speed	Communications time (ms) N : No. of bytes processed
DATA READ	High speed	$T=0.23N+18.6$
	Normal speed	$T=0.89N+32.3$
DATA WRITE (with verification)	High speed	$T=11.2N+17.0$
	Normal speed	$T=16.4N+31.3$
DATA WRITE (without verification)	High speed	$T=11.0N+12.2$
	Normal speed	$T=15.5N+24.2$

Single-access		
	RF communications speed	Communications time (ms) N : No. of Tags
Multi-ID READ	High speed	$T=19.6N+21.6$
	Normal speed	$T=32.8N+25.8$
Multi-DATA READ	High speed	$T=29.8N+22.2$
	Normal speed	$T=66.4N+33.9$

● DATA READ (Single-access)

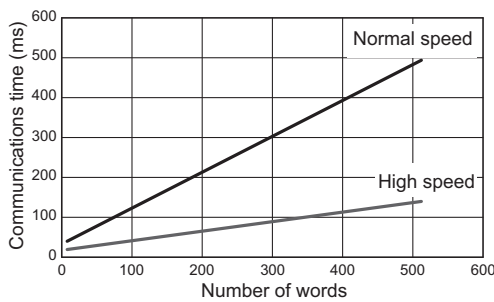

● DATA WRITE (Single-access)

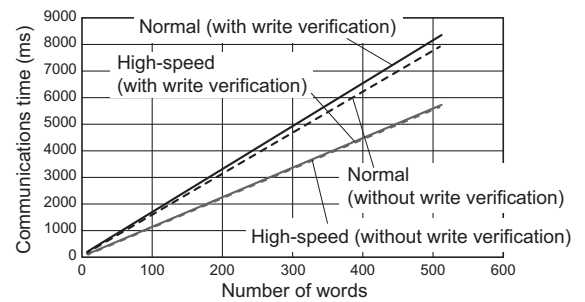

● ID READ (Multi-access)

During 6-word (96bit) data readout from the UII (EPC) area

• Firmware Ver 3.01 or later

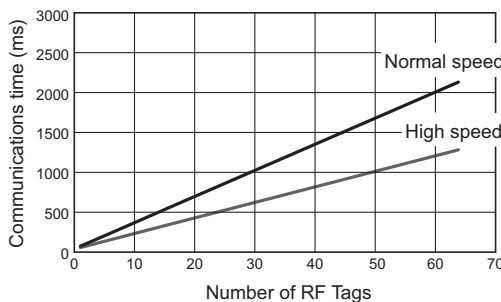

• Firmware Ver 3.00 or earlier

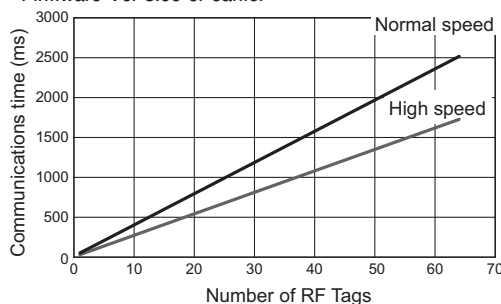

● DATA READ (Multi-access)

Reading 32 Words of Data from the User Area

• Firmware Ver 3.01 or later

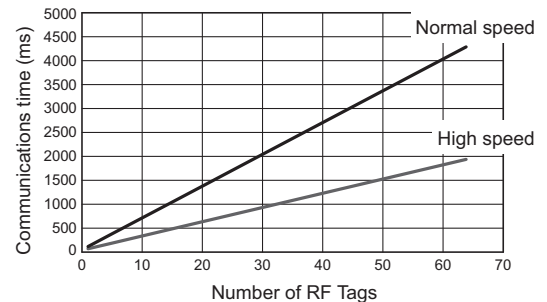

• Firmware Ver 3.00 or earlier

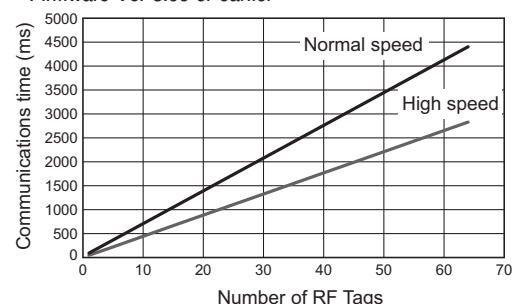

V780-HMD68-ETN-KR/V780-HMD68-ETN-KR-S

● ID READ (Single-access)

During 6-word (96bit) data readout from the UII (EPC) area

RF communications speed	Communications time
High speed	21 ms
Normal speed	27 ms

Single-access

	RF communications speed	Communications time (ms) N : No. of bytes processed
DATA READ	High speed	$T=0.33N+23.8$
	Normal speed	$T=0.68N+30.4$
DATA WRITE (with verification)	High speed	$T=12.3N+13.2$
	Normal speed	$T=15.1N+20.1$
DATA WRITE (without verification)	High speed	$T=11.9N+11.8$
	Normal speed	$T=14.4N+17.1$

Single-access

	RF communications speed	Communications time (ms) N : No. of Tags
Multi-ID READ	High speed	$T=20.3N+25.1$
	Normal speed	$T=27.7N+33.5$
Multi-DATA READ	High speed	$T=33.2N+22.0$
	Normal speed	$T=52.8N+33.6$

● DATA READ (Single-access)

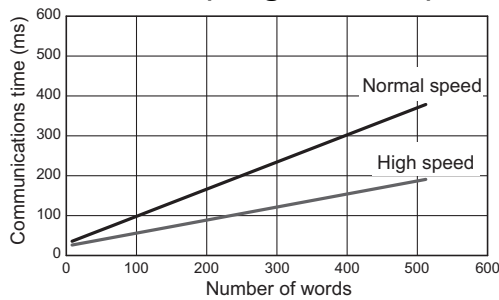

● DATA WRITE (Single-access)

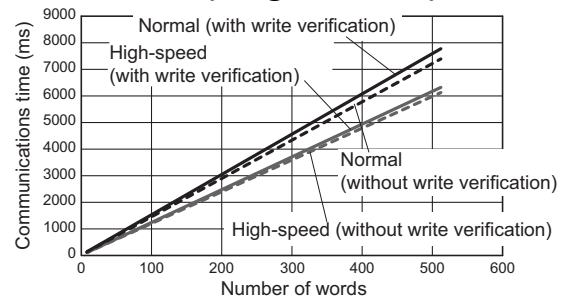

● ID READ (Multi-access)

During 6-word (96bit) data readout from the UII (EPC) area

• Firmware Ver 3.01 or later

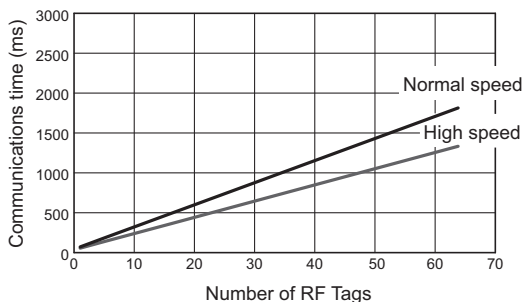

• Firmware Ver 3.00 or earlier

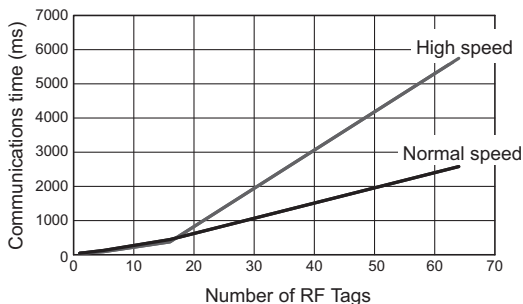

● DATA READ (Multi-access)

Reading 32 Words of Data from the User Area

• Firmware Ver 3.01 or later

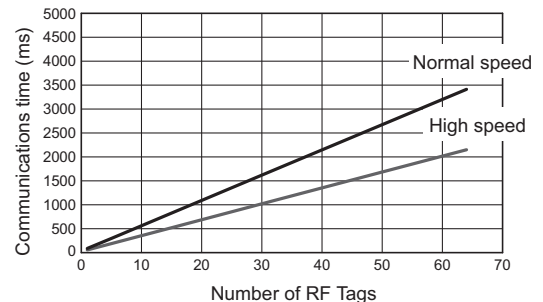

Firmware Ver 3.00 or earlier

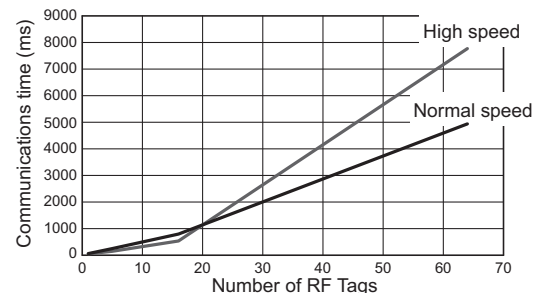

V780-HMD68-ETN-CN/V780-HMD68-ETN-CN-S

● ID READ (Single-access)

During 6-word (96bit) data readout from the Ull (EPC) area

RF communications speed	Communications time
High speed	17 ms
Normal speed	29 ms

Single-access

	RF communications speed	Communications time (ms) N : No. of bytes processed
DATA READ	High speed	$T=0.33N+19.2$
	Normal speed	$T=1.04N+32.9$
DATA WRITE (with verification)	High speed	$T=11.5N+15.3$
	Normal speed	$T=16.9N+28.8$
DATA WRITE (without verification)	High speed	$T=11.2N+13.1$
	Normal speed	$T=15.8N+25.3$

Single-access

	RF communications speed	Communications time (ms) N : No. of Tags
Multi-ID READ	High speed	$T=21.3N+18.5$
	Normal speed	$T=34.7N+24.3$
Multi-DATA READ	High speed	$T=29.9N+20.2$
	Normal speed	$T=69.1N+26.7$

● DATA READ (Single-access)

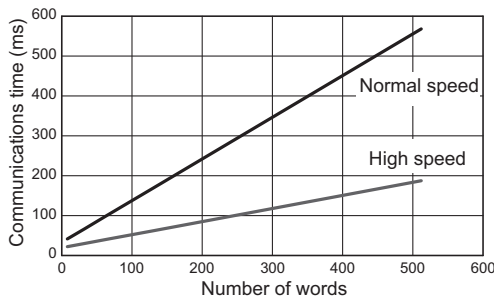

● DATA WRITE (Single-access)

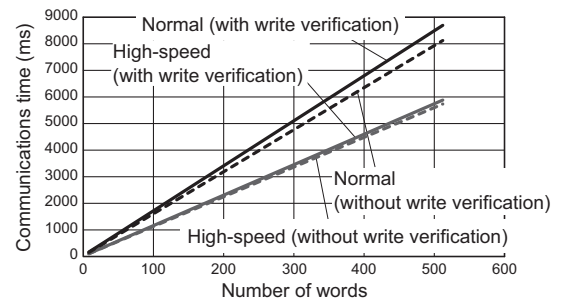

● ID READ (Multi-access)

During 6-word (96bit) data readout from the Ull (EPC) area

• Firmware Ver 3.01 or later

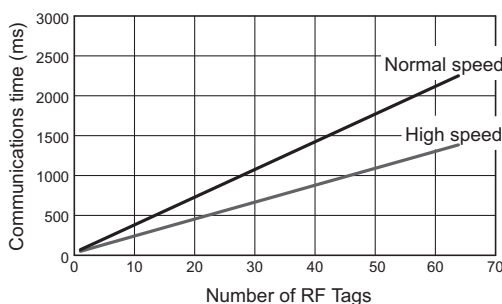

• Firmware Ver 3.00 or earlier

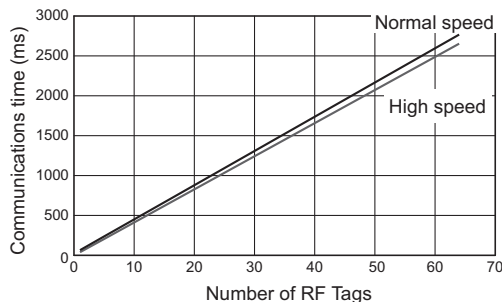

● DATA READ (Multi-access)

Reading 32 Words of Data from the User Area

• Firmware Ver 3.01 or later

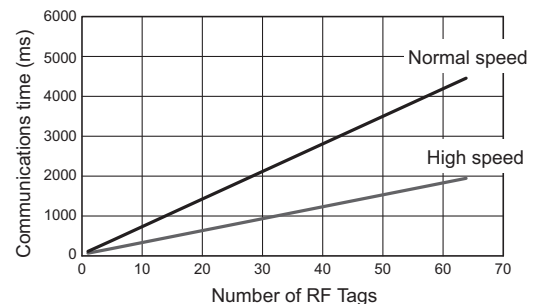

• Firmware Ver 3.00 or earlier

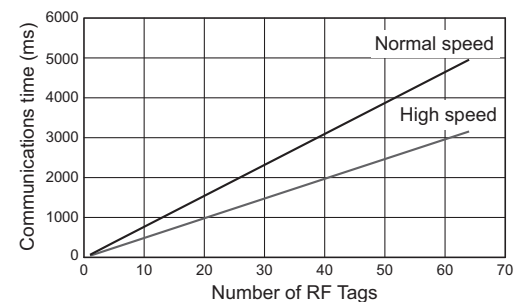

V780-HMD68-ETN-TW/V780-HMD68-ETN-TW-S

● ID READ (Single-access)

During 6-word (96bit) data readout from the UII (EPC) area

RF communications speed	Communications time
High speed	21 ms
Normal speed	27 ms

Single-access

	RF communications speed	Communications time (ms) N : No. of bytes processed
DATA READ	High speed	$T=0.33N+23.8$
	Normal speed	$T=0.68N+30.4$
DATA WRITE (with verification)	High speed	$T=12.3N+13.2$
	Normal speed	$T=15.1N+20.1$
DATA WRITE (without verification)	High speed	$T=11.9N+11.8$
	Normal speed	$T=14.4N+17.1$

Single-access

	RF communications speed	Communications time (ms) N : No. of Tags
Multi-ID READ	High speed	$T=20.3N+25.1$
	Normal speed	$T=27.7N+33.5$
Multi-DATA READ	High speed	$T=33.2N+22.0$
	Normal speed	$T=52.8N+33.6$

● DATA READ (Single-access)

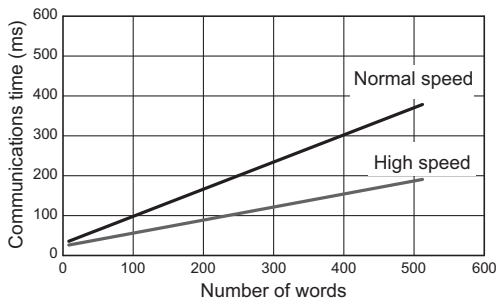

● DATA WRITE (Single-access)

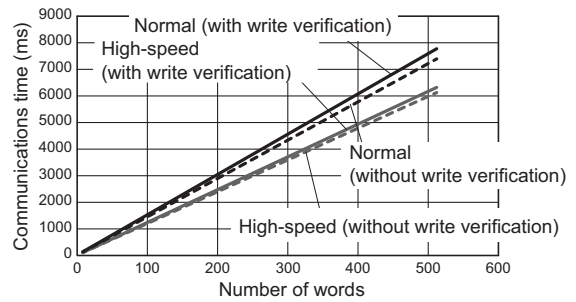

● ID READ (Multi-access)

During 6-word (96bit) data readout from the UII (EPC) area

• Firmware Ver 3.01 or later

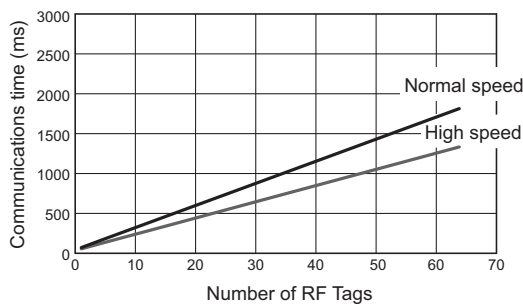

• Firmware Ver 3.00 or earlier

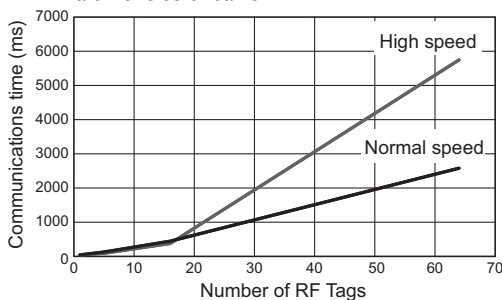

● DATA READ (Multi-access)

Reading 32 Words of Data from the User Area

• Firmware Ver 3.01 or later

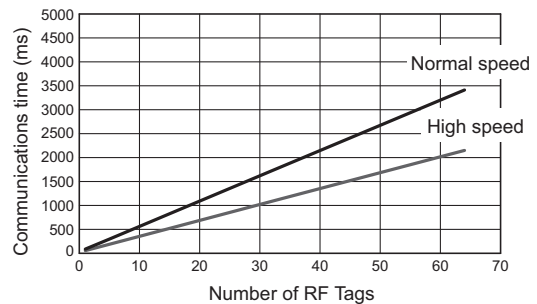

Firmware Ver 3.00 or earlier

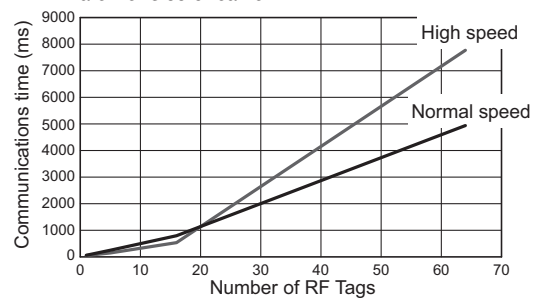

V780-HMD68-ETN-IN/V780-HMD68-ETN-IN-S

● ID READ (Single-access)

During 6-word (96bit) data readout from the Ull (EPC) area

RF communications speed	Communications time
High speed	21 ms
Normal speed	27 ms

Single-access		
	RF communications speed	Communications time (ms) N : No. of bytes processed
DATA READ	High speed	$T=0.33N+188$
	Normal speed	$T=0.69N+25.0$
DATA WRITE (with verification)	High speed	$T=11.6N+29.7$
	Normal speed	$T=14.8N+31.8$
DATA WRITE (without verification)	High speed	$T=11.2N+27.2$
	Normal speed	$T=14.0N+28.9$

Single-access		
	RF communications speed	Communications time (ms) N : No. of Tags
Multi-ID READ	High speed	$T=20.4N+23.5$
	Normal speed	$T=24.4N+25.2$
Multi-DATA READ	High speed	$T=30.1N+19.2$
	Normal speed	$T=45.2N+34.7$

● DATA READ (Single-access)

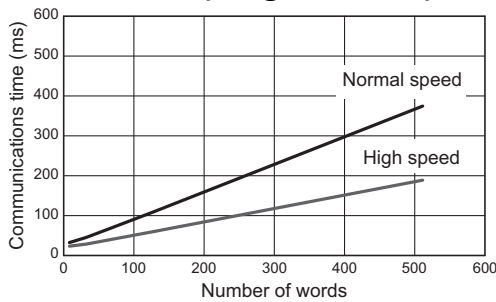

● DATA WRITE (Single-access)

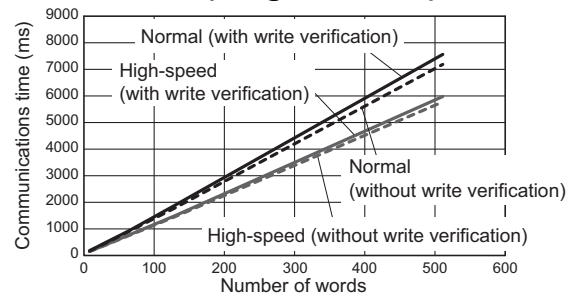

● ID READ (Multi-access)

During 6-word (96bit) data readout from the Ull (EPC) area

• Firmware Ver 3.01 or later

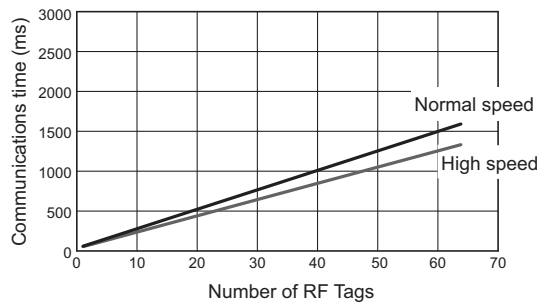

• Firmware Ver 3.00 or earlier

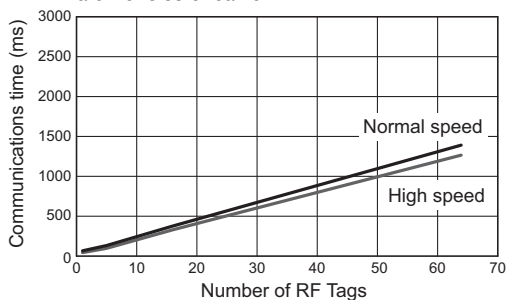

● DATA READ (Multi-access)

Reading 32 Words of Data from the User Area

• Firmware Ver 3.01 or later

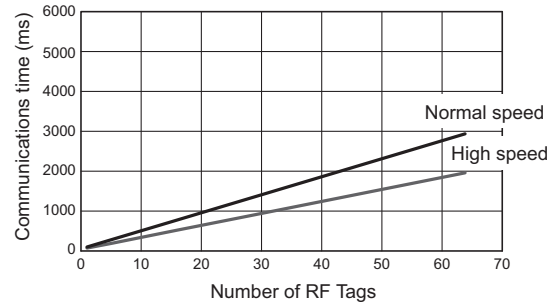

Firmware Ver 3.00 or earlier

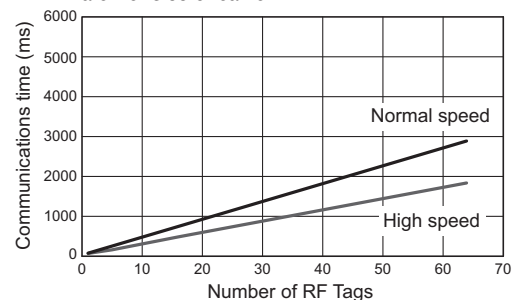

V780-HMD68-ETN-ID/V780-HMD68-ETN-ID-S

● ID READ (Single-access)

During 6-word (96bit) data readout from the UII (EPC) area

RF communications speed	Communications time
High speed	21 ms
Normal speed	27 ms

Single-access

	RF communications speed	Communications time (ms) N : No. of bytes processed
DATA READ	High speed	$T=0.33N+23.8$
	Normal speed	$T=0.68N+30.4$
DATA WRITE (with verification)	High speed	$T=12.3N+13.2$
	Normal speed	$T=15.1N+20.1$
DATA WRITE (without verification)	High speed	$T=11.9N+11.8$
	Normal speed	$T=14.4N+17.1$

Single-access

	RF communications speed	Communications time (ms) N : No. of Tags
Multi-ID READ	High speed	$T=20.3N+25.1$
	Normal speed	$T=27.7N+33.5$
Multi-DATA READ	High speed	$T=33.2N+22.0$
	Normal speed	$T=52.8N+33.6$

● DATA READ (Single-access)

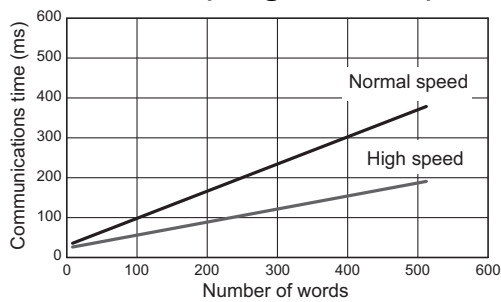

● DATA WRITE (Single-access)

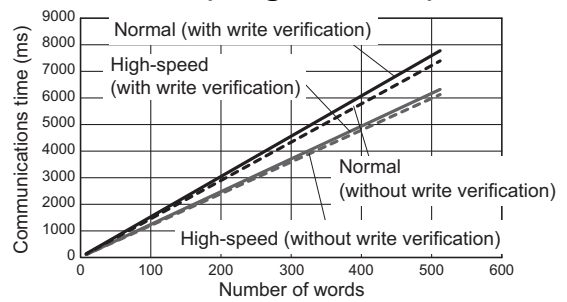

● ID READ (Multi-access)

During 6-word (96bit) data readout from the UII (EPC) area

• Firmware Ver 3.01 or later

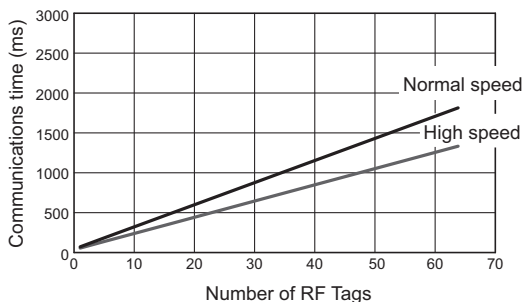

• Firmware Ver 3.00 or earlier

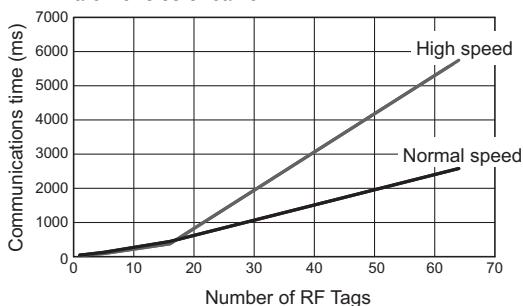

● DATA READ (Multi-access)

Reading 32 Words of Data from the User Area

• Firmware Ver 3.01 or later

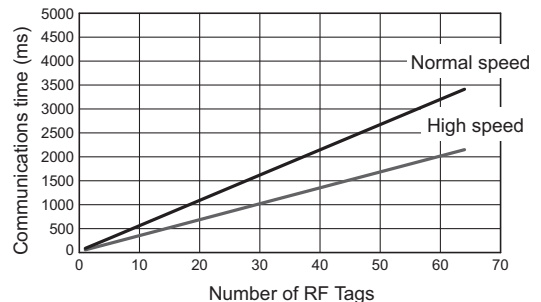

Firmware Ver 3.00 or earlier

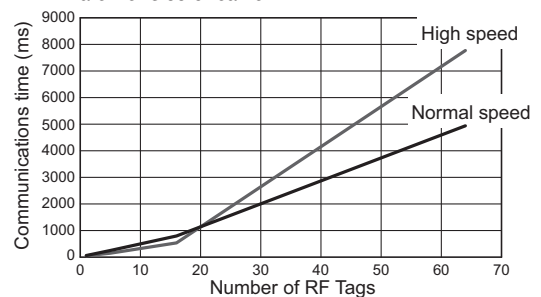

V780-HMD68-ETN-MY/V780-HMD68-ETN-MY-S

● ID READ (Single-access)

During 6-word (96bit) data readout from the UII (EPC) area

RF communications speed	Communications time
High speed	21 ms
Normal speed	27 ms

Single-access

	RF communications speed	Communications time (ms) N : No. of bytes processed
DATA READ	High speed	$T=0.33N+23.8$
	Normal speed	$T=0.68N+30.4$
DATA WRITE (with verification)	High speed	$T=12.3N+13.2$
	Normal speed	$T=15.1N+20.1$
DATA WRITE (without verification)	High speed	$T=11.9N+11.8$
	Normal speed	$T=14.4N+17.1$

Single-access

	RF communications speed	Communications time (ms) N : No. of Tags
Multi-ID READ	High speed	$T=20.3N+25.1$
	Normal speed	$T=27.7N+33.5$
Multi-DATA READ	High speed	$T=33.2N+22.0$
	Normal speed	$T=52.8N+33.6$

● DATA READ (Single-access)

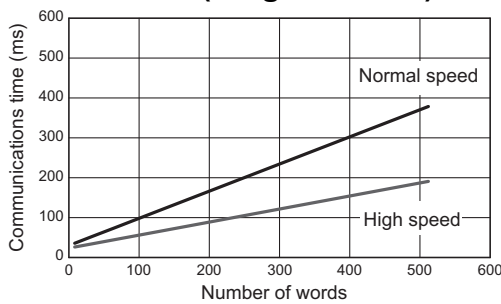

● DATA WRITE (Single-access)

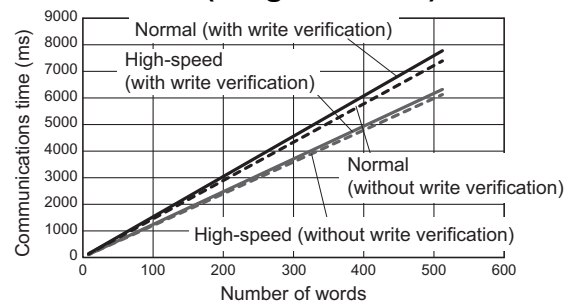

● ID READ (Multi-access)

During 6-word (96bit) data readout from the UII (EPC) area

• Firmware Ver 3.01 or later

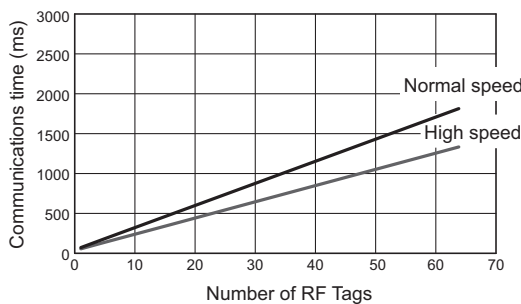

• Firmware Ver 3.00 or earlier

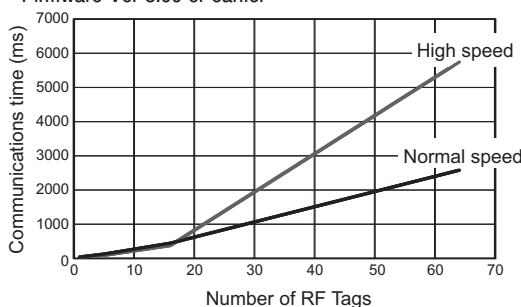

● DATA READ (Multi-access)

Reading 32 Words of Data from the User Area

• Firmware Ver 3.01 or later

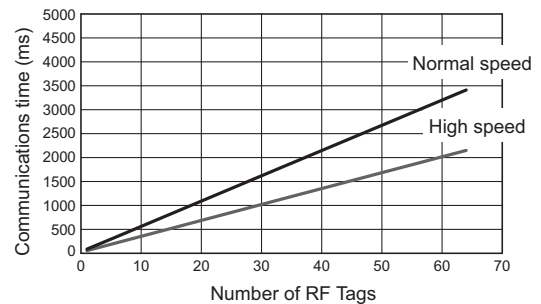

Firmware Ver 3.00 or earlier

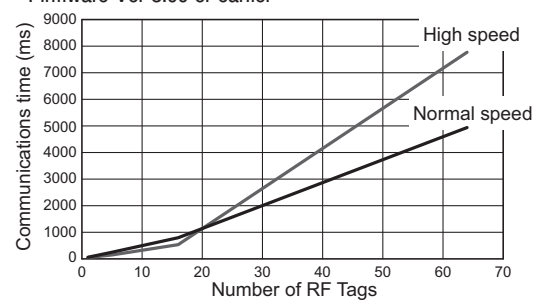

V780-HMD68-ETN-SG/V780-HMD68-ETN-SG-S

● ID READ (Single-access)

During 6-word (96bit) data readout from the UII (EPC) area

RF communications speed	Communications time
High speed	21 ms
Normal speed	27 ms

Single-access

	RF communications speed	Communications time (ms) N : No. of bytes processed
DATA READ	High speed	$T=0.33N+23.8$
	Normal speed	$T=0.68N+30.4$
DATA WRITE (with verification)	High speed	$T=12.3N+13.2$
	Normal speed	$T=15.1N+20.1$
DATA WRITE (without verification)	High speed	$T=11.9N+11.8$
	Normal speed	$T=14.4N+17.1$

Single-access

	RF communications speed	Communications time (ms) N : No. of Tags
Multi-ID READ	High speed	$T=20.3N+25.1$
	Normal speed	$T=27.7N+33.5$
Multi-DATA READ	High speed	$T=33.2N+22.0$
	Normal speed	$T=52.8N+33.6$

● DATA READ (Single-access)

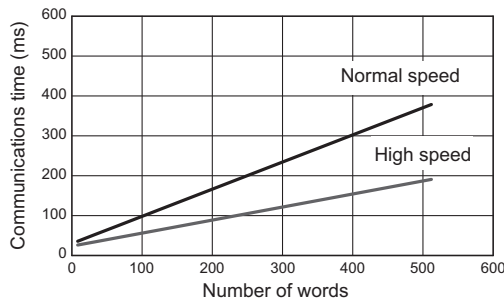

● DATA WRITE (Single-access)

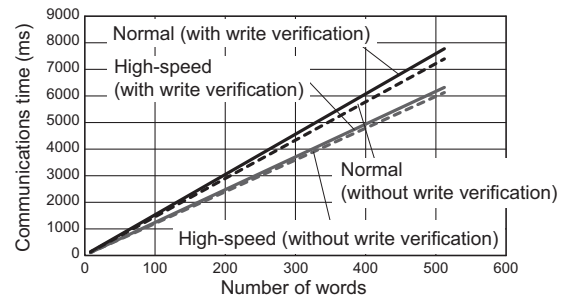

● ID READ (Multi-access)

During 6-word (96bit) data readout from the UII (EPC) area

• Firmware Ver 3.01 or later

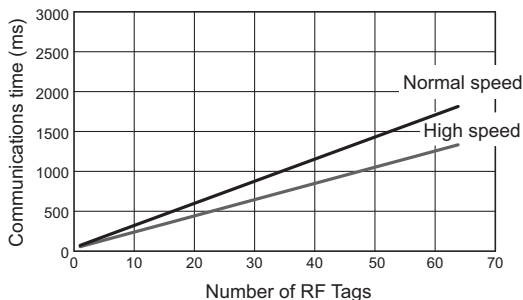

• Firmware Ver 3.00 or earlier

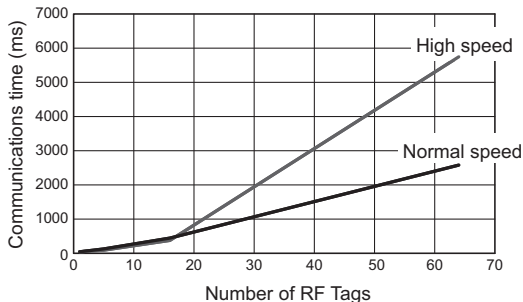

● DATA READ (Multi-access)

Reading 32 Words of Data from the User Area

• Firmware Ver 3.01 or later

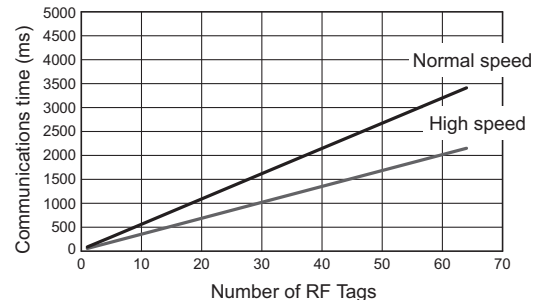

Firmware Ver 3.00 or earlier

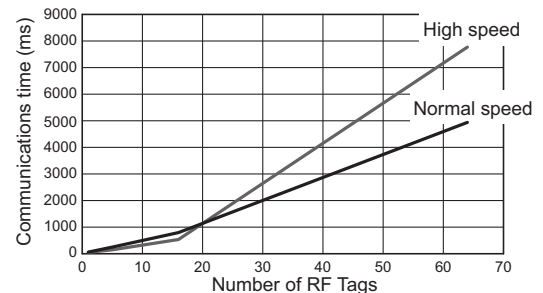

V780-HMD68-ETN-EU/V780-HMD68-ETN-EU-S

● ID READ (Single-access)

During 6-word (96bit) data readout from the UII (EPC) area

RF communications speed	Communications time
High speed	21 ms
Normal speed	27 ms

	RF communications speed	Communications time (ms) N : No. of bytes processed
DATA READ	High speed	$T=0.33N+188$
	Normal speed	$T=0.69N+25.0$
DATA WRITE (with verification)	High speed	$T=11.6N+29.7$
	Normal speed	$T=14.8N+31.8$
DATA WRITE (without verification)	High speed	$T=11.2N+27.2$
	Normal speed	$T=14.0N+28.9$

	RF communications speed	Communications time (ms) N : No. of Tags
Multi-ID READ	High speed	$T=20.4N+23.5$
	Normal speed	$T=24.4N+25.2$
Multi-DATA READ	High speed	$T=30.1N+19.2$
	Normal speed	$T=45.2N+34.7$

● DATA READ (Single-access)

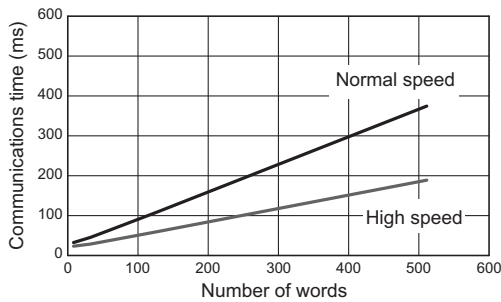

● DATA WRITE (Single-access)

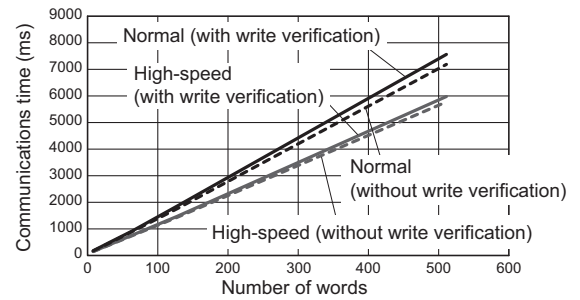

● ID READ (Multi-access)

During 6-word (96bit) data readout from the UII (EPC) area

• Firmware Ver 3.01 or later

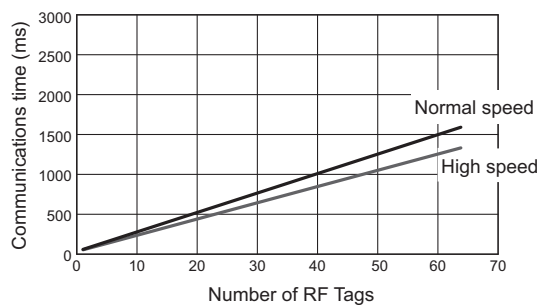

• Firmware Ver 3.00 or earlier

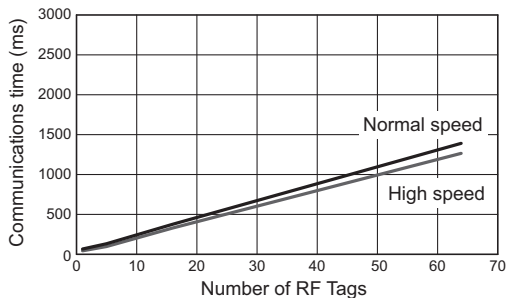

● DATA READ (Multi-access)

Reading 32 Words of Data from the User Area

• Firmware Ver 3.01 or later

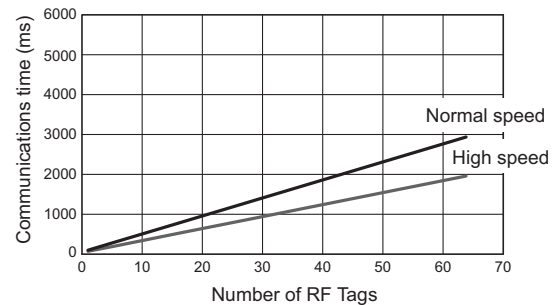

Firmware Ver 3.00 or earlier

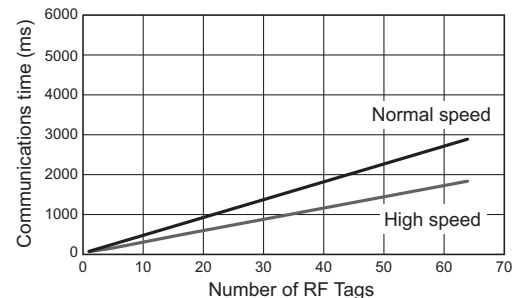

V780-HMD68-ETN-RU/V780-HMD68-ETN-RU-S

● ID READ (Single-access)

During 6-word (96bit) data readout from the UII (EPC) area

RF communications speed	Communications time
High speed	21 ms
Normal speed	27 ms

Single-access

	RF communications speed	Communications time (ms) N : No. of bytes processed
DATA READ	High speed	$T=0.33N+188$
	Normal speed	$T=0.69N+25.0$
DATA WRITE (with verification)	High speed	$T=11.6N+29.7$
	Normal speed	$T=14.8N+31.8$
DATA WRITE (without verification)	High speed	$T=11.2N+27.2$
	Normal speed	$T=14.0N+28.9$

Single-access

	RF communications speed	Communications time (ms) N : No. of Tags
Multi-ID READ	High speed	$T=20.4N+23.5$
	Normal speed	$T=24.4N+25.2$
Multi-DATA READ	High speed	$T=30.1N+19.2$
	Normal speed	$T=45.2N+34.7$

● DATA READ (Single-access)

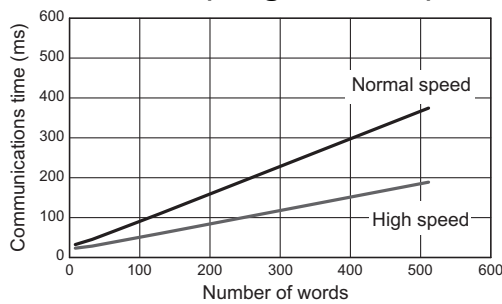

● DATA WRITE (Single-access)

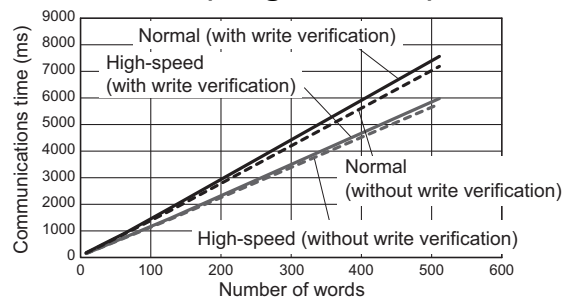

● ID READ (Multi-access)

During 6-word (96bit) data readout from the UII (EPC) area

• Firmware Ver 3.01 or later

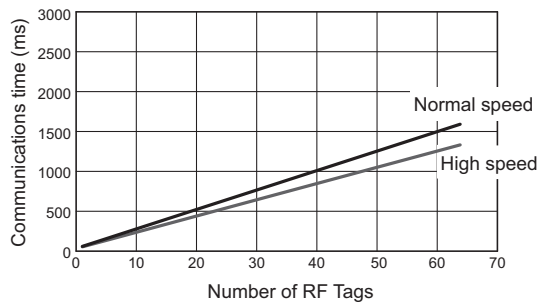

• Firmware Ver 3.00 or earlier

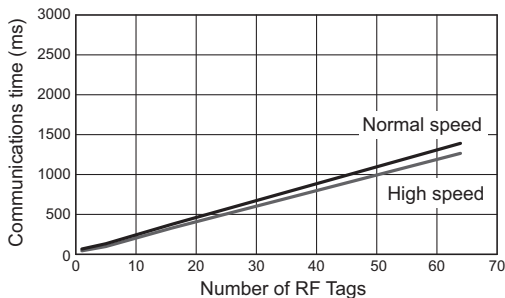

● DATA READ (Multi-access)

Reading 32 Words of Data from the User Area

• Firmware Ver 3.01 or later

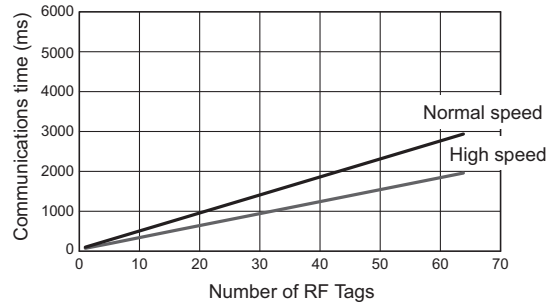

Firmware Ver 3.00 or earlier

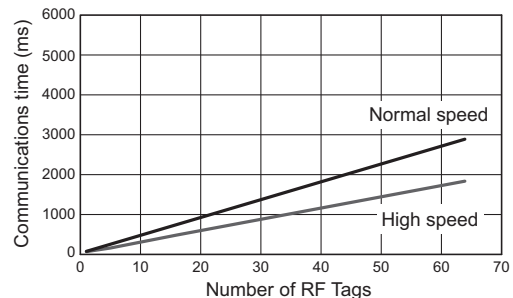

V780-HMD68-ETN-US/V780-HMD68-ETN-US-S

● ID READ (Single-access)

During 6-word (96bit) data readout from the UII (EPC) area

RF communications speed	Communications time
High speed	21 ms
Normal speed	27 ms

Single-access

	RF communications speed	Communications time (ms) N : No. of bytes processed
DATA READ	High speed	$T=0.33N+23.8$
	Normal speed	$T=0.68N+30.4$
DATA WRITE (with verification)	High speed	$T=12.3N+13.2$
	Normal speed	$T=15.1N+20.1$
DATA WRITE (without verification)	High speed	$T=11.9N+11.8$
	Normal speed	$T=14.4N+17.1$

Single-access

	RF communications speed	Communications time (ms) N : No. of Tags
Multi-ID READ	High speed	$T=20.3N+25.1$
	Normal speed	$T=27.7N+33.5$
Multi-DATA READ	High speed	$T=33.2N+22.0$
	Normal speed	$T=52.8N+33.6$

● DATA READ (Single-access)

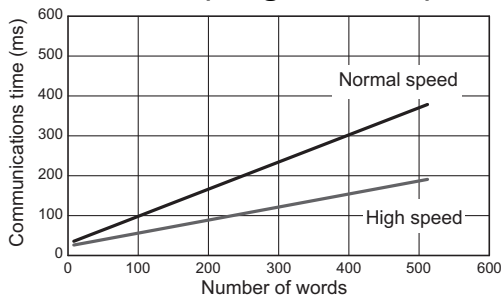

● DATA WRITE (Single-access)

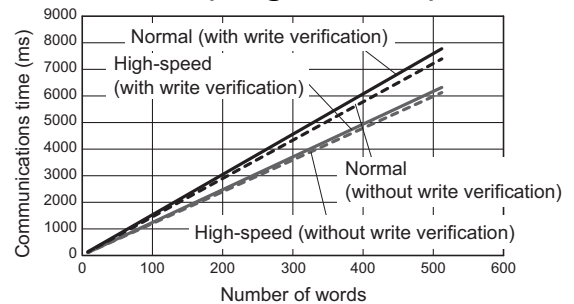

● ID READ (Multi-access)

During 6-word (96bit) data readout from the UII (EPC) area

• Firmware Ver 3.01 or later

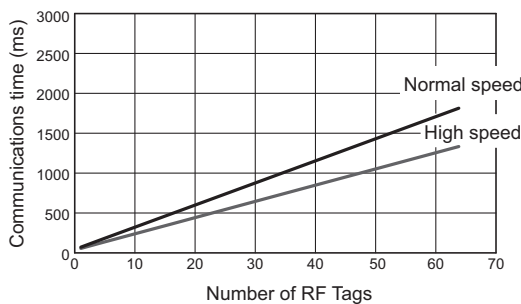

• Firmware Ver 3.00 or earlier

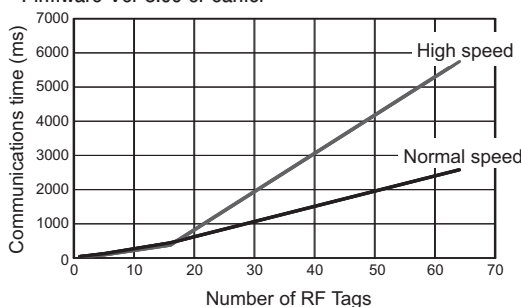

● DATA READ (Multi-access)

Reading 32 Words of Data from the User Area

• Firmware Ver 3.01 or later

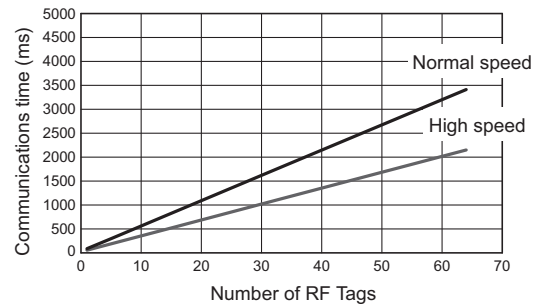

Firmware Ver 3.00 or earlier

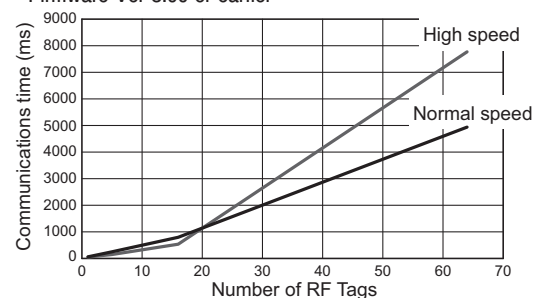

V780-HMD68-ETN-MX/V780-HMD68-ETN-MX-S

● ID READ (Single-access)

During 6-word (96bit) data readout from the UII (EPC) area

RF communications speed	Communications time
High speed	21 ms
Normal speed	27 ms

Single-access

	RF communications speed	Communications time (ms) N : No. of bytes processed
DATA READ	High speed	$T=0.33N+23.8$
	Normal speed	$T=0.68N+30.4$
DATA WRITE (with verification)	High speed	$T=12.3N+13.2$
	Normal speed	$T=15.1N+20.1$
DATA WRITE (without verification)	High speed	$T=11.9N+11.8$
	Normal speed	$T=14.4N+17.1$

Single-access

	RF communications speed	Communications time (ms) N : No. of Tags
Multi-ID READ	High speed	$T=20.3N+25.1$
	Normal speed	$T=27.7N+33.5$
Multi-DATA READ	High speed	$T=33.2N+22.0$
	Normal speed	$T=52.8N+33.6$

● DATA READ (Single-access)

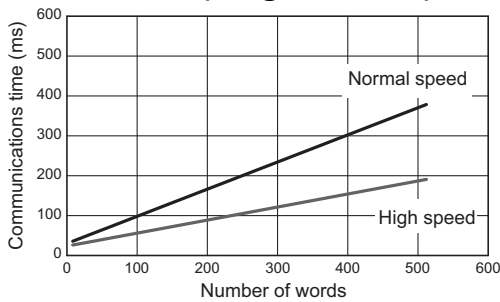

● DATA WRITE (Single-access)

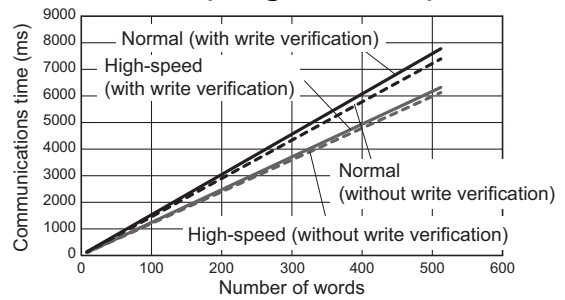

● ID READ (Multi-access)

During 6-word (96bit) data readout from the UII (EPC) area

• Firmware Ver 3.01 or later

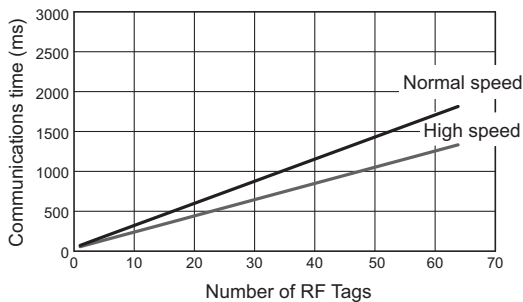

● DATA READ (Multi-access)

Reading 32 Words of Data from the User Area

• Firmware Ver 3.01 or later

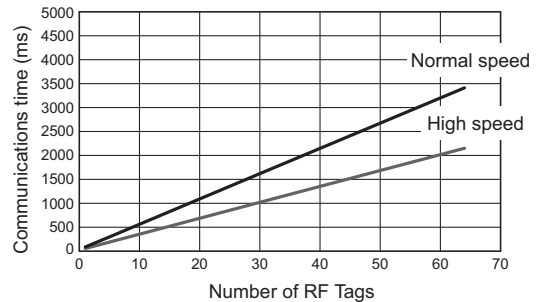

• Firmware Ver 3.00 or earlier

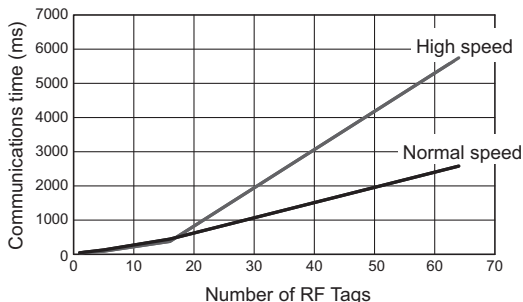

Firmware Ver 3.00 or earlier

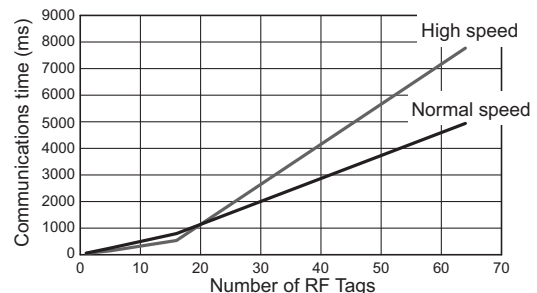

A-3 RF Tag Memory Map

Specify the addresses in the following memory map for the data pointers in the command you send to the Reader/Writer.

V780-A-JIME-Z3BLI-10 (Recommended) Memory Map

Memory bank	Bit address (hex)	Word address (hex)	Bit													
			15	14	13	12	11	10	9	8	7	6	5	4	3	
User area (bank 11)	1FF0-1FFF	1FF	USER [15 : 0]													R/W *1
													R/W *1
	00-0F	00	USER [8191 : 8176]													R/W *1
TID area (bank 10)	B0-BF	0B	RFS UII (EPC) [15 : 0]													R/W *1
													R/W *1
	60-6F	06	RFS_UII (EPC) [95 : 80]													R/W *1
	50-5F	05	TID_SERIAL [15 : 0]													RO *2
	40-4F	04	TID_SERIAL [31 : 16]													RO *2
	30-3F	03	TID_SERIAL [47 : 32]													RO *2
	20-2F	02	TDTS_ [15 : 0] := 2000 hex													RO *2
	10-1F	01	0000 (binary)	TID_MODEL[7 : 0] 15 hex (Gen2 model number is address 14 hex to 1F hex)									TID_DESIGNER[3:0] = 1000 (binary)			RO *2
00-0F	00	TID_DESIGNER [10:4] = 0000000 (binary) (Gen2 mask designer is address 08 to 13 hex.)					XTI D=1	CLASS_ID [7:0] = 01000111 (binary)								
UII (EPC) area (bank 01)	90-9F	09	UII (EPC) [15 : 0]													R/W *1
													R/W *1
	20-2F	02	UII (EPC) [127 : 112]													R/W *1
	10-1F	01	NSI[8:0] (Numbering System Identifier, default 00000000 (binary))							XI=0	UMI	UII (EPC)_LENGTH[4 : 0]				R/W *1
	00-0F	00	UII (EPC)_CRC-16 [15 : 0]													RO *2
Reserv ed area (bank 00)	A0-AF	0A	RF1 _DI S	RF2 _DI S	DCI _RF _EN	RFS _ME M	RES _SR	BPL _EN	WW U	RFU=0					RO *2	
	90-9F	09	BPERMALOCK [0:15]													RO *2
	80-8F	08	RESERVED													RO *2
													RO *2
	50-5F	05	RESERVED													RO *2
	40-4F	04	I2C_ADDR [1 : 0]	KILL	RFU=0				LOC K_D A	LOCK_USE R[1 : 0]	LOCK_EPC [1 : 0]	LOCK_AC-CESS[1 : 0]	LOCK_KILL [1 : 0]	RO *2		
	30-3F	03	ACCESS_PASSWORD [15 : 0]													R/W *1
	20-2F	02	ACCESS_PASSWORD [31 : 16]													R/W *1
	10-1F	01	KILL_PASSWORD [15 : 0]													R/W *1
	00-0F	00	KILL_PASSWORD [31 : 16]													R/W *1

*1. R/W (Read/Write): Data can be read and written for the area.

*2. RO (Read Only): Data can be read from the area but not written to it.



A-4 Communications Range Diagram, Reception Level Diagram (Reference Only)

● Communications range

The communications range differs depending on the radio regulations of each country. Moreover, the communications range may change under the influence of the ambient environment, type of RF Tags, and the items on which RF Tags are mounted. Sufficiently verify the communications range in advance.



Additional Information

The diagram shows characteristics when the mounting material is a 400 × 300 × 1 mm aluminum plate. The directional characteristics of the RF Tag will change with the size of the metal surface.

● Reception level

You can obtain the reception level from an RF Tag. The unit is dBm and values are given in 1-dB increments. The reception level will vary with the ambient environment, type of RF Tag, and the items on which RF Tags are mounted. Sufficiently verify the communications field in advance.

- Note 1. The reception level will attenuate by approx. 6 dBm when the distance between the Reader/Writer and RF Tag is doubled.
2. The obtained values were input at the edge of the Reader/Writer antenna. They are not the levels received by the antenna.



Precautions for Correct Use

The obtained values may be different in any specific application. The values obtained with RSSI also vary with the RF Tags that are used, the orientation of the RF Tags, and the ambient environment. Therefore, the reception levels in the above graphs are strictly for reference only. Use these value only as reference to confirm leeway in the RF Tag communications levels in the actual environment.

Measurement Conditions

● Communications Range Measurement Conditions

Measurement environment	Radio wave darkroom
RF Tag	V780-A-JIME-Z3BLI-10 (made by Toppan Forms Co., Ltd.)* ¹
Transmission power	27 dBm
Communications command	DATA READ and DATA WRITE

*1. The RF Tag was mounted to a V780-A-TA-133-10 Attachment.

● Reception Level Measurement Conditions

Measurement environment	Radio wave darkroom
RF Tag	V780-A-JIME-Z3BLI-10 (made by Toppan Forms Co., Ltd.)
Transmission power	27 dBm
Communications command	ID READ

V780-HMD68-ETN-JP/V780-HMD68-ETN-JP-S

● Communications range

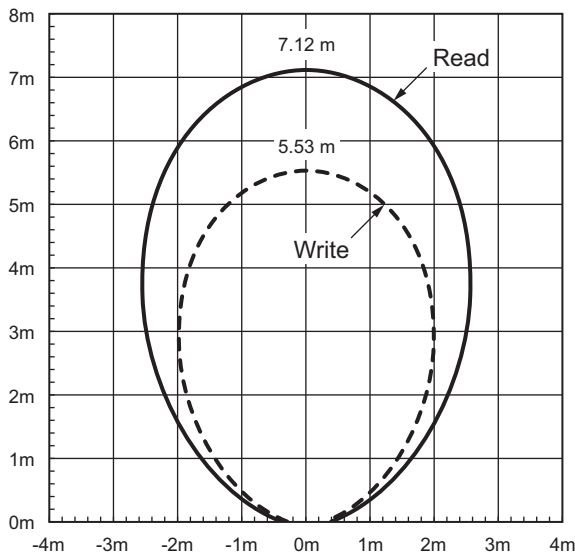

● Reception level

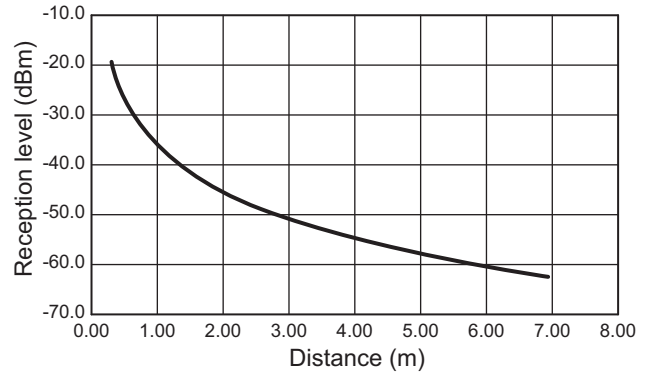

V780-HMD68-ETN-KR/V780-HMD68-ETN-KR-S

● Communications range

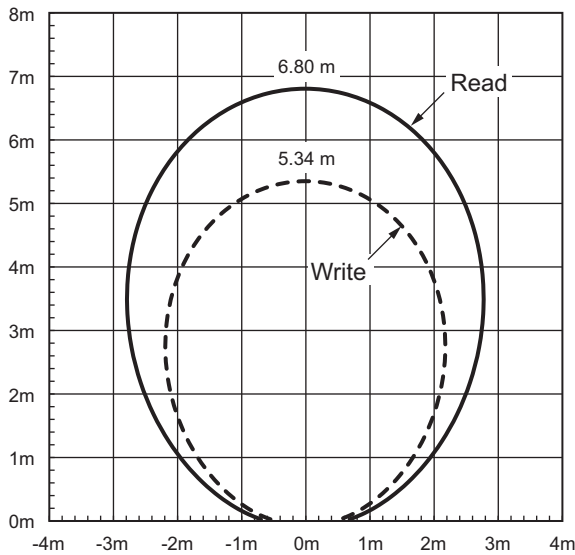

● Reception level

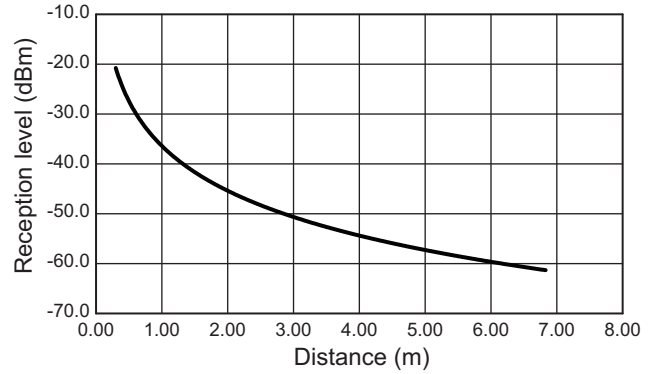

V780-HMD68-ETN-CN/V780-HMD68-ETN-CN-S

● Communications range

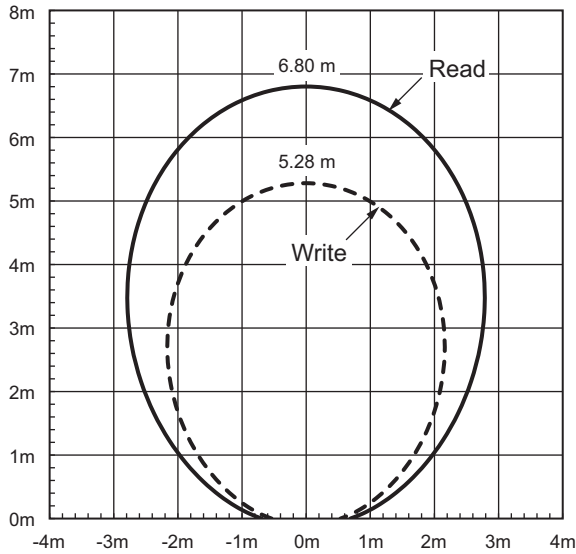

● Reception level

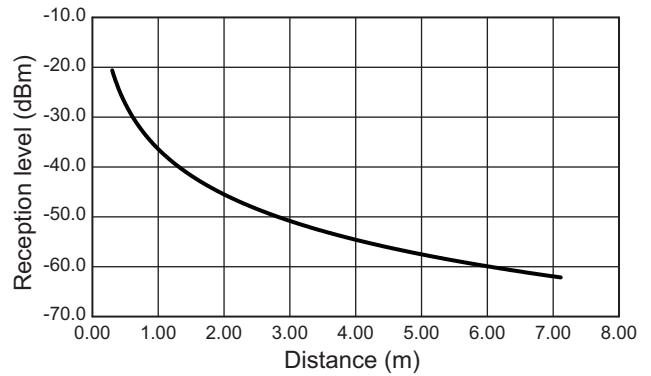

V780-HMD68-ETN-TW/V780-HMD68-ETN-TW-S

● Communications range

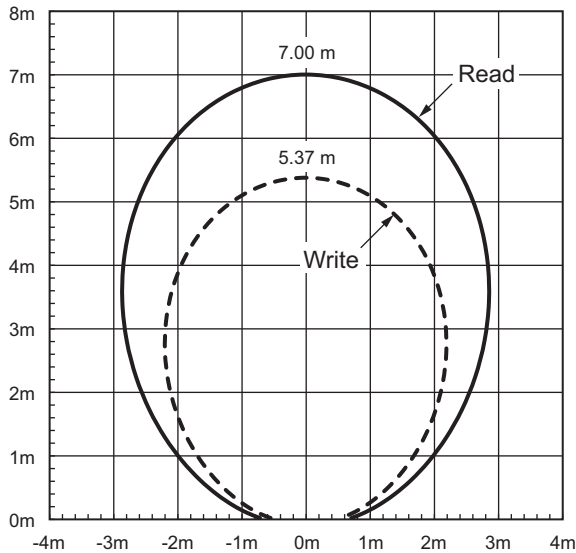

● Reception level

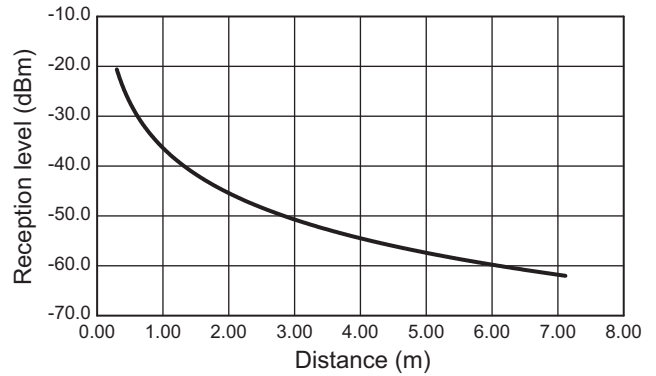

V780-HMD68-ETN-IN/V780-HMD68-ETN-IN-S

● **Communications range**

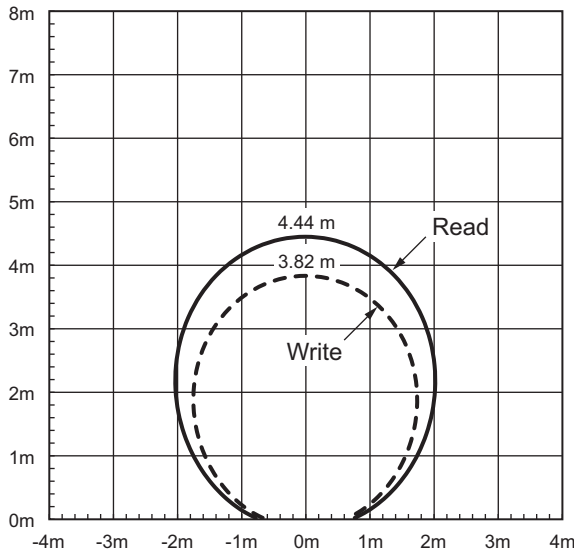

● **Reception level**

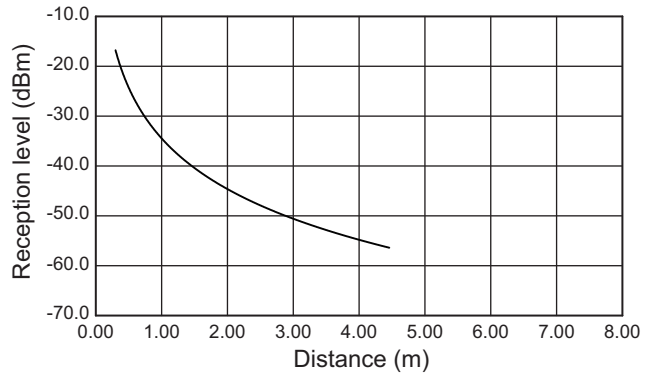

V780-HMD68-ETN-ID/V780-HMD68-ETN-ID-S

● **Communications range**

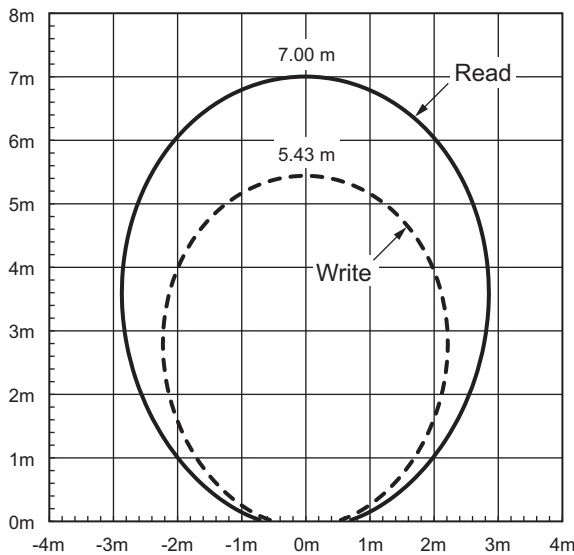

● **Reception level**

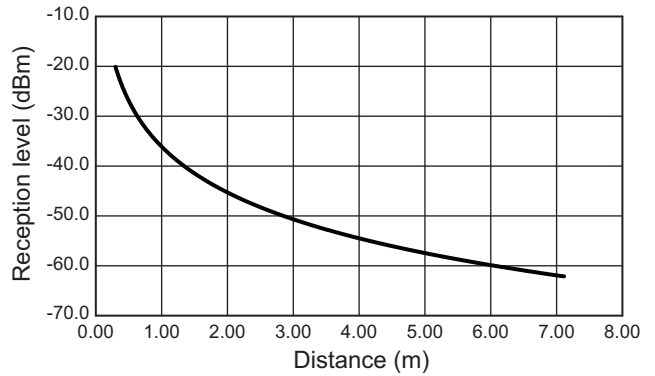

V780-HMD68-ETN-MY/V780-HMD68-ETN-MY-S

● Communications range

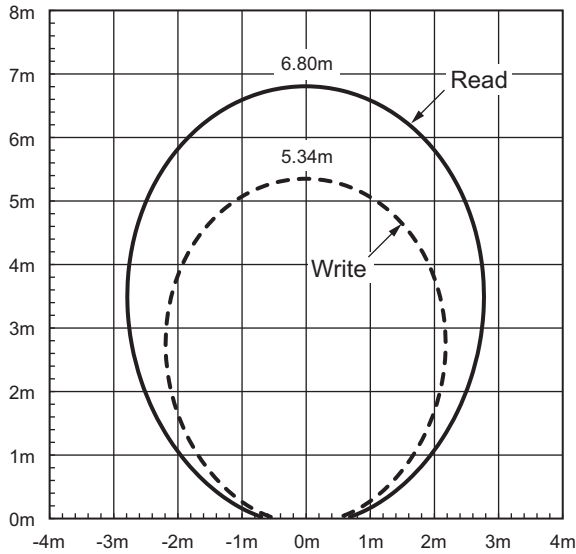

● Reception level

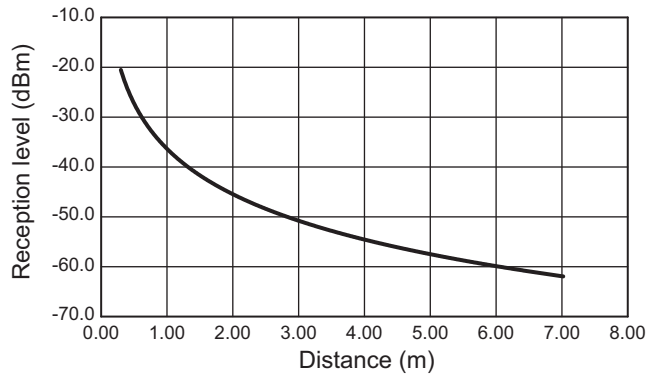

V780-HMD68-ETN-SG/V780-HMD68-ETN-SG-S

● Communications range

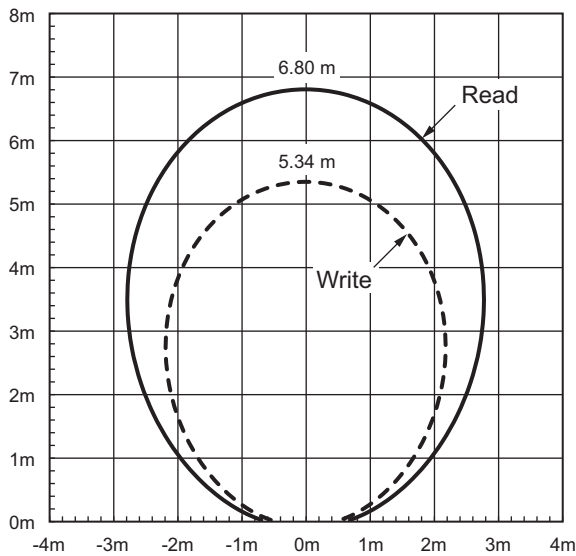

● Reception level

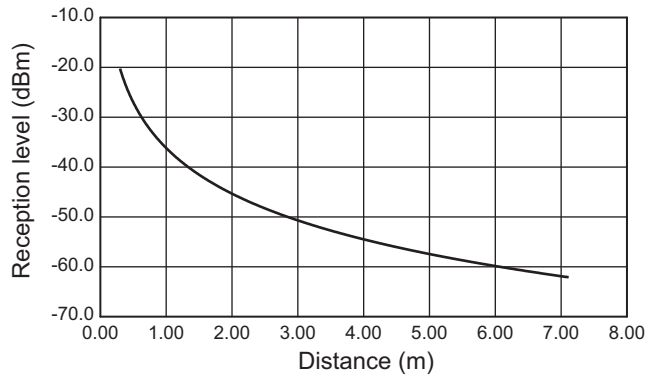

V780-HMD68-ETN-EU/V780-HMD68-ETN-EU-S

● Communications range

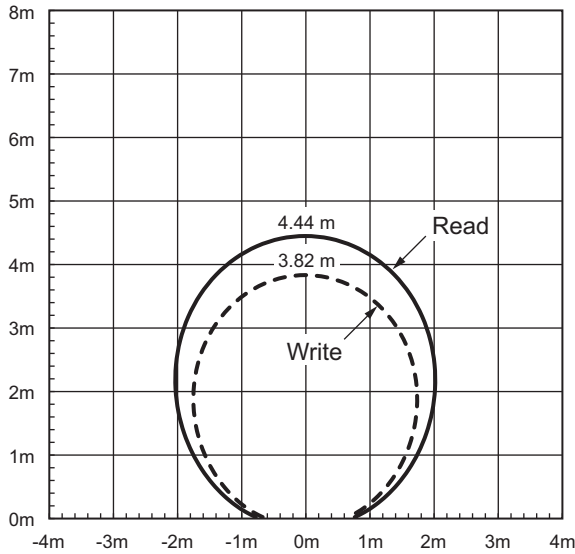

● Reception level

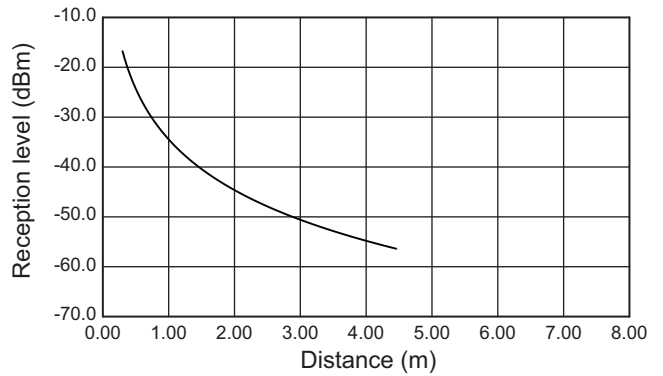

V780-HMD68-ETN-RU/V780-HMD68-ETN-RU-S

● Communications range

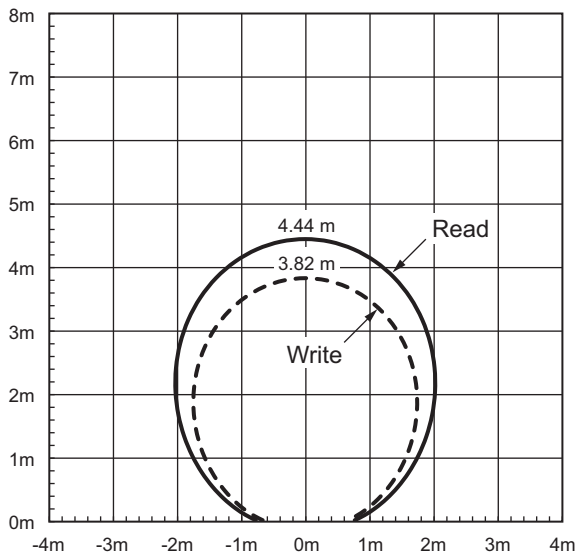

● Reception level

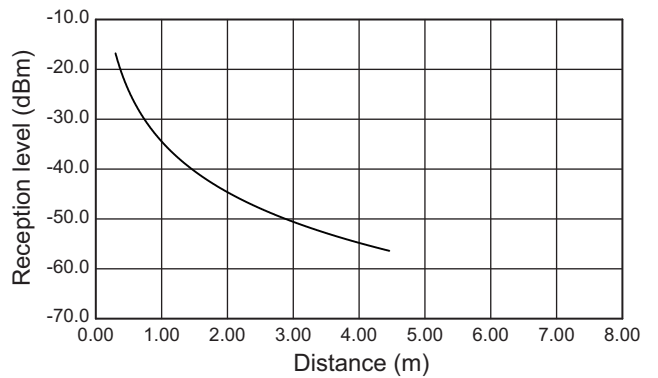

V780-HMD68-ETN-US/V780-HMD68-ETN-US-S

● Communications range

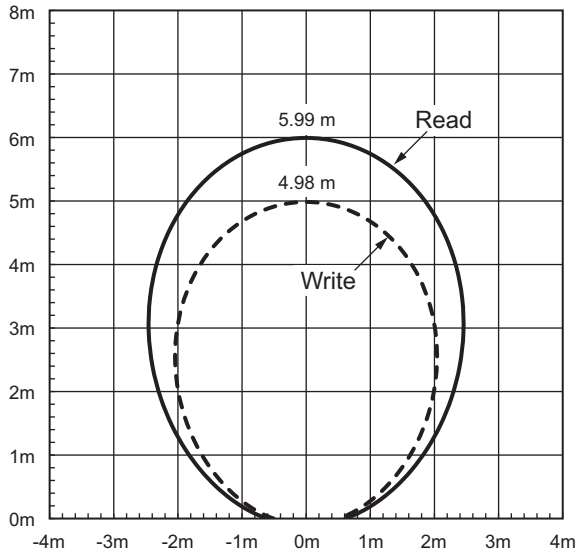

● Reception level

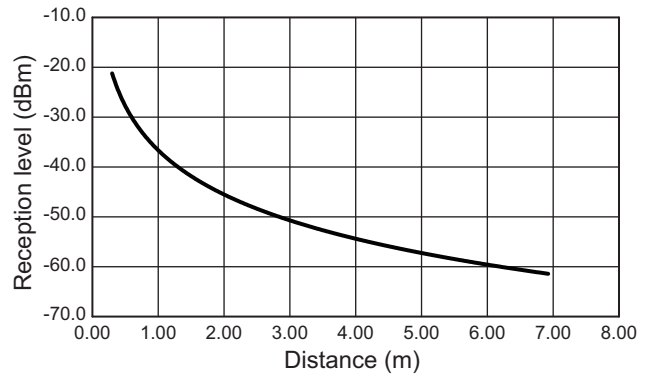

V780-HMD68-ETN-MX/V780-HMD68-ETN-MX-S

● Communications range

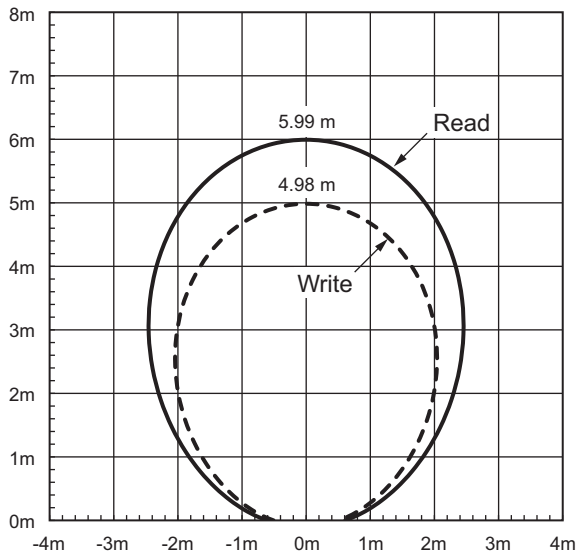

● Reception level

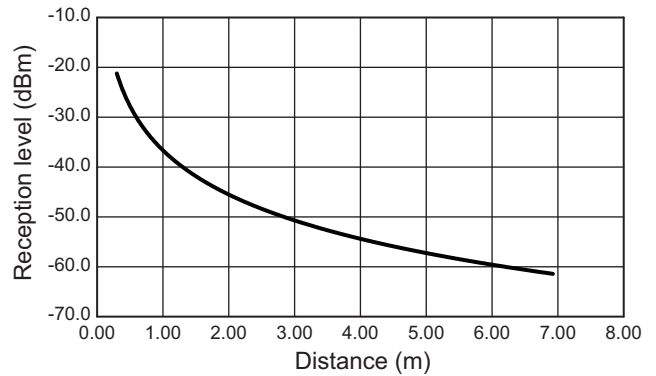

A-5 Mutual Interference of Reader/Writers (Reference Only)

If multiple Reader/Writers are installed in parallel to each other, radio wave mutual interference will affect communications with RF Tags.

When installing the Reader/Writer, refer to mounting interval described below.



Precautions for Correct Use

If the mounting interval between Reader/Writers is too short, radio wave mutual interference will cause the communications success rate to drop. The amount of mutual interference depends on the installation environment, the transmission powers of the Reader/Writers, and other factors. Sufficiently check operation in advance.

There is no need to consider the mounting interval, for Readers/Writers that are connected using the Multi-Reader/Writer function. There is no influence of mounting interval, if the Reader/Writer is attached closely.

Measurement Conditions

RF Tag	V780-A-JIME-Z3BLI-10 (made by Toppan Forms Co., Ltd.)
Distance from Reader/Writer to RF Tag	1 m (fixed)
Transmission power	27 dBm
Channel	Auto channel
RF communications speed	Auto speed
Communications command	ID READ

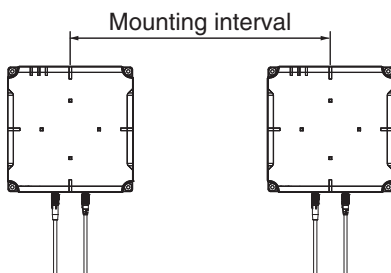

V780-HMD68-ETN-JP/V780-HMD68-ETN-JP-S

Mounting interval	Communications success rate for measurement Reader/Writer
145 cm	100%
125 cm	99%
115 cm	98%
105 cm	98%
85 cm	98%
65 cm	96%
45 cm	96%
25 cm	95%

V780-HMD68-ETN-KR/V780-HMD68-ETN-KR-S

Mounting interval	Communications success rate for measurement Reader/Writer
145 cm	100%
125 cm	98%
115 cm	96%
105 cm	90%
85 cm	81%
65 cm	77%
45 cm	77%
25 cm	77%

V780-HMD68-ETN-CN/V780-HMD68-ETN-CN-S

Mounting interval	Communications success rate for measurement Reader/Writer
145 cm	100%
125 cm	99%
115 cm	87%
105 cm	90%
85 cm	80%
65 cm	80%
45 cm	80%
25 cm	80%

V780-HMD68-ETN-TW/V780-HMD68-ETN-TW-S

Mounting interval	Communications success rate for measurement Reader/Writer
145 cm	100%
125 cm	98%
115 cm	96%
105 cm	90%
85 cm	81%
65 cm	77%
45 cm	77%
25 cm	77%

V780-HMD68-ETN-IN/V780-HMD68-ETN-IN-S

Mounting interval	Communications success rate for measurement Reader/Writer
145 cm	100%
125 cm	100%
115 cm	97%
105 cm	96%
85 cm	93%
65 cm	96%
45 cm	93%
25 cm	92%

V780-HMD68-ETN-ID/V780-HMD68-ETN-ID-S

Mounting interval	Communications success rate for measurement Reader/Writer
145 cm	100%
125 cm	98%
115 cm	96%
105 cm	90%
85 cm	81%
65 cm	77%
45 cm	77%
25 cm	77%

V780-HMD68-ETN-MY/V780-HMD68-ETN-MY-S

Mounting interval	Communications success rate for measurement Reader/Writer
145 cm	100%
125 cm	98%
115 cm	96%
105 cm	90%
85 cm	81%
65 cm	77%
45 cm	77%
25 cm	77%

V780-HMD68-ETN-SG/V780-HMD68-ETN-SG-S

Mounting interval	Communications success rate for measurement Reader/Writer
145 cm	100%
125 cm	98%
115 cm	96%
105 cm	90%
85 cm	81%
65 cm	77%
45 cm	77%
25 cm	77%

V780-HMD68-ETN-EU/V780-HMD68-ETN-EU-S

Mounting interval	Communications success rate for measurement Reader/Writer
145 cm	100%
125 cm	100%
115 cm	97%
105 cm	96%
85 cm	93%
65 cm	96%
45 cm	93%
25 cm	92%

V780-HMD68-ETN-RU/V780-HMD68-ETN-RU-S

Mounting interval	Communications success rate for measurement Reader/Writer
145 cm	100%
125 cm	100%
115 cm	97%
105 cm	96%
85 cm	93%
65 cm	96%
45 cm	93%
25 cm	92%

V780-HMD68-ETN-US/V780-HMD68-ETN-US-S

Mounting interval	Communications success rate for measurement Reader/Writer
145 cm	100%
125 cm	98%
115 cm	96%
105 cm	90%
85 cm	81%
65 cm	77%
45 cm	77%
25 cm	77%

V780-HMD68-ETN-MX/V780-HMD68-ETN-MX-S

Mounting interval	Communications success rate for measurement Reader/Writer
145 cm	100%
125 cm	98%
115 cm	96%
105 cm	90%
85 cm	81%
65 cm	77%
45 cm	77%
25 cm	77%

A-6 Chemical Resistance of the Reader/Writers

The case of a Reader/Writer is made from PBT (polybutylene terephthalate) resin and aluminum diecast. Refer to the following lists and do not use chemicals that affect PBT resin and aluminum diecast.

Applicable Model

V780-HMD68-ETN-□□/V780-HMD68-ETN-□□-S

● Chemicals That Cause Deformations, Cracks, Etc.

Chemical names

Acetone, trichloroethylene, ethylene dichloride, sodium hydroxide, other alkaline substances, hydrochloric acid (35% or higher), and sulphuric acid (70% or higher)

● Chemicals That May Cause Discoloration, Swelling, Etc.

Chemical names

Hydrochloric acid (10% RT), acetic acid (5% RT), benzene, and nitric acid (20% or higher)



Precautions for Correct Use

- Other chemicals that are not listed above may also affect a Reader/Writer. Perform sufficient testing in advance.
- This RF Tag cannot be used in applications that require explosion-proof specifications.

A-7 For customers using Reader/Writer earlier than firmware Ver.4.00.

A-7-1 Operating environment when using a web browser.

The system requirements to use the Web browser are as follows:

- Windows 7, Windows 8.1, or Windows 10 with Internet Explorer 8 or higher
- The combination of the firmware version and the JRE version

Reader/Writer firmware version \ JRE version	Java7	Java8	
		Update74 to Update201	Update211 or later*1
Ver.1.01	Available	Available	Available
Ver.2.00	Available	Available	Available
Ver.3.00	Available	Available	Available

*1. Commercial license is required for Java 8 Update 211(April 16, 2019).



Precautions for Correct Use

- There is case where WEB browser can not be used in a combination of the firmware version of Reader/Writer and the JRE version.

Refer to the table above, please use the JRE version that was appropriate for your Reader/Writer.

* Java software can be downloaded from the following URL:

URL: <https://www.oracle.com/technetwork/java/archive-139210.html>

(*URL is as of April 2019 and may change in the future.)

A-7-2 Cannot Display the Web Browser Operation Window

Problem

When the Web browser Reader/Writer interface is used to display the Web operation window, the OMRON logo is displayed and an error message is displayed instead of the operation menu.

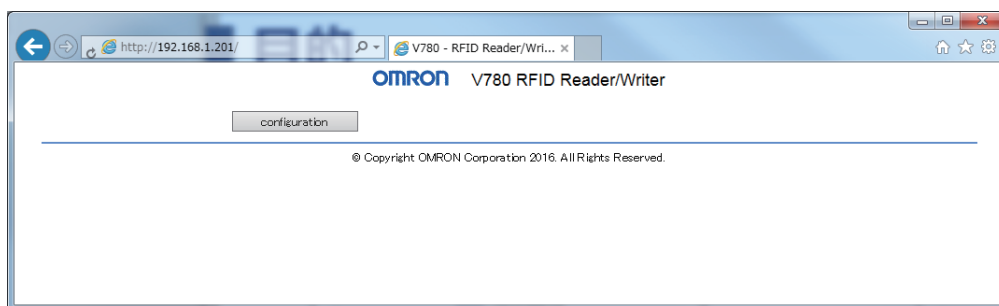
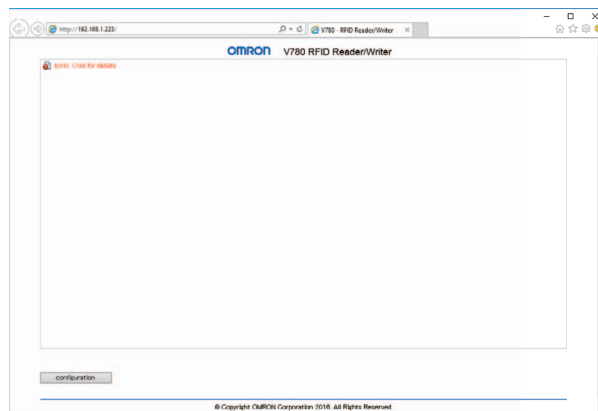
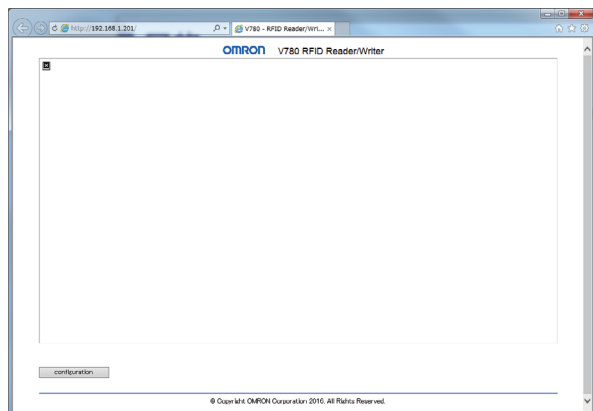

Solution

Check the message that appears when you try to start the Web browser interface, and then perform the corresponding procedure.

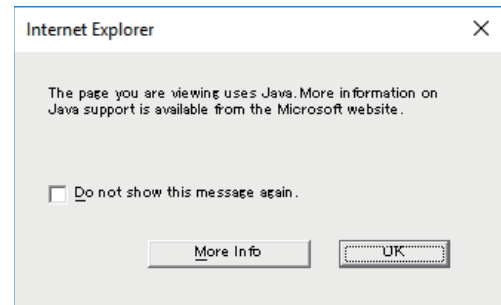
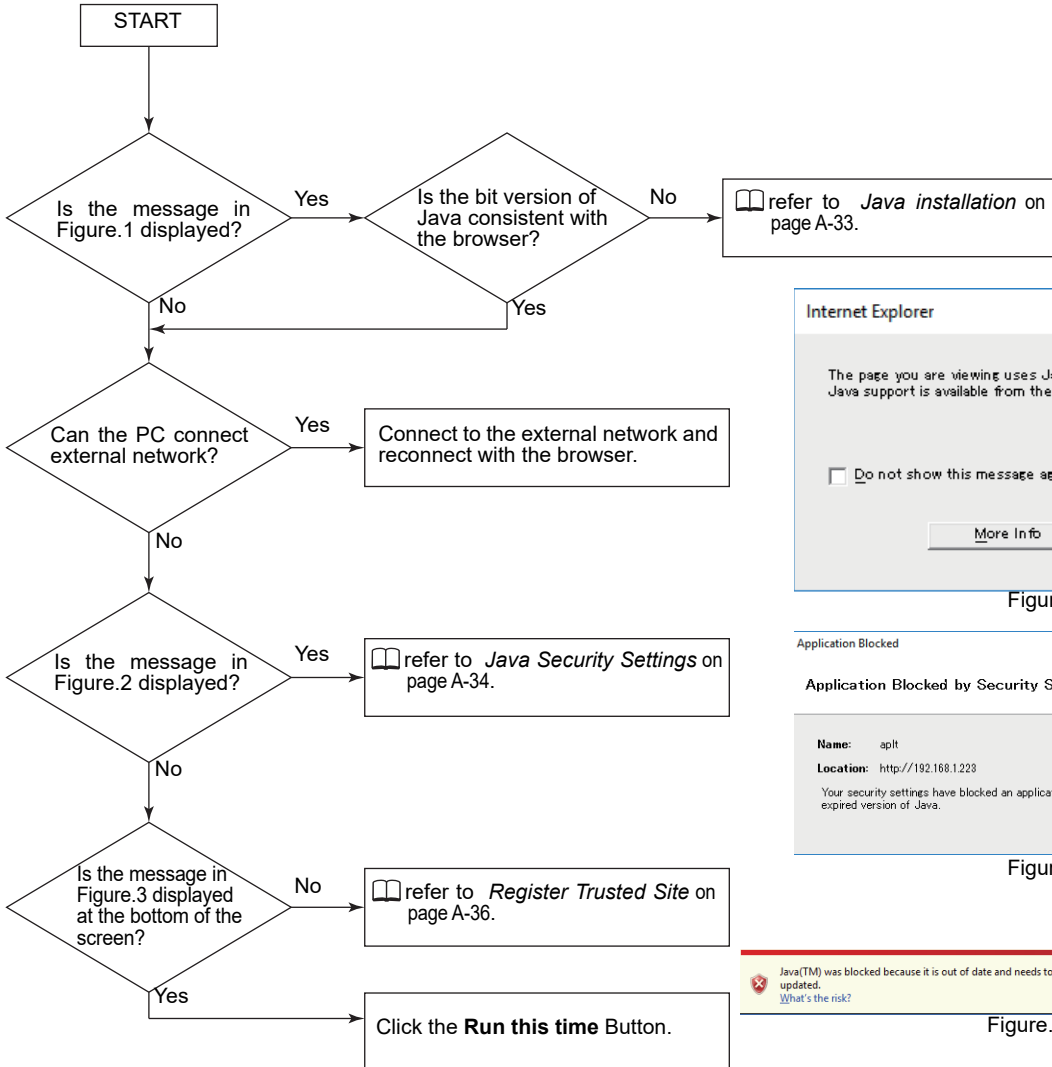

Figure.1

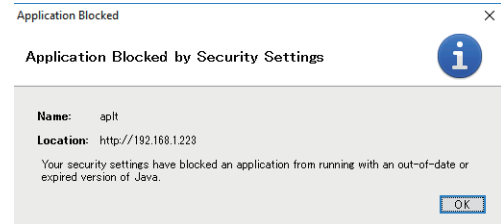

Figure.2

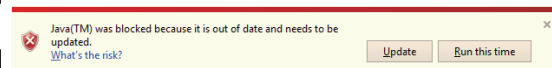
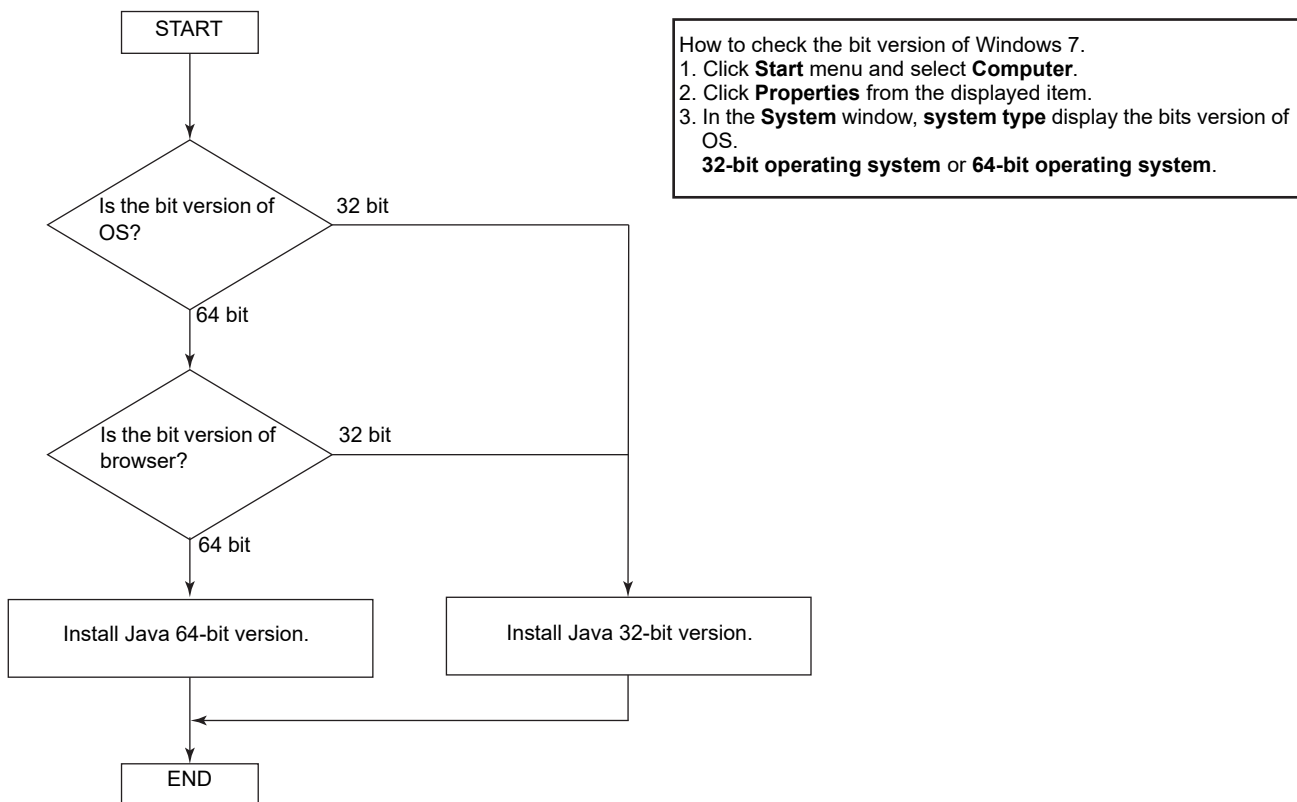

Figure.3

Java installation

Install Java bit version (64-bit or /32-bit) decided by the following flow.



Java Security Settings

(1) Open the Control Panel and click the **Java** icon.

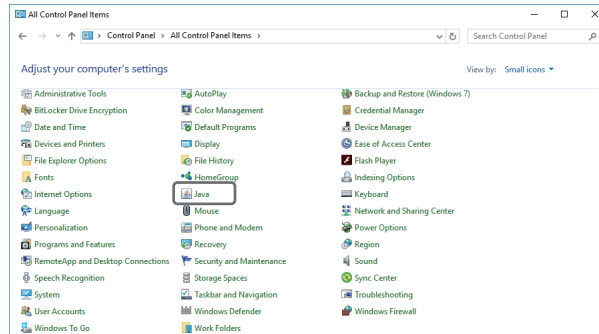

(2) Click the **Security** Tab and change the security level from **High** to **Medium**.

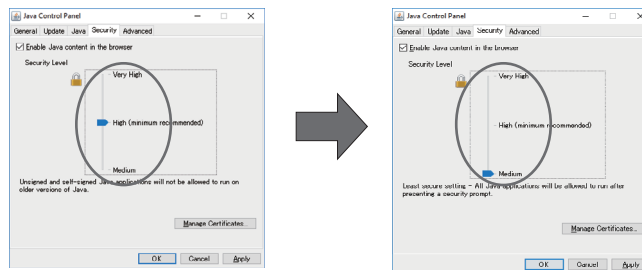

Precautions for Correct Use

Java security features have been improved for the most recent version of Java, so the same problem may occur.

(3) Restart the web browser and access the IP address of the Reader/Writer again.

The following warning message displayed at the first time. Click the **Run** button.

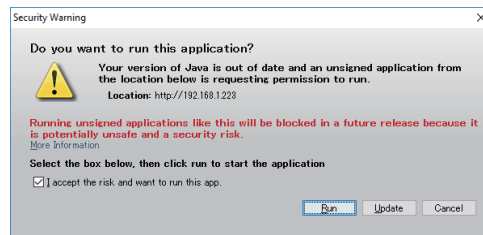

Java Security Settings Are Not Displayed

This section describes the countermeasure when the exception site list is not displayed and operation is not possible.

If the tab page to change Java security settings does not appear and you cannot change the settings when you select the Security Tab in step 2 of the procedure in Countermeasure for Security Settings, use the following procedure.

- (1) Open the Control Panel and uninstall all Java programs.
- (2) After you uninstall all of the programs, go to the following website and install Java.

<https://www.oracle.com/technetwork/java/archive-139210.html>

(*URL is as of April 2019 and may change in the future.)



Precautions for Correct Use

Refer to *8-1 Browser Operation Interface* on page 8-2 for the Java versions that can be used.



Precautions for Correct Use

Java security features have been improved for the most recent version of Java, so the same problem may occur.

Register Trusted Site

- (1) Open the Web browser, click the **Tools** menu and select **Internet Options**.
- (2) Click the **Security** tab, select **Trusted sites** and click **Sites** button.

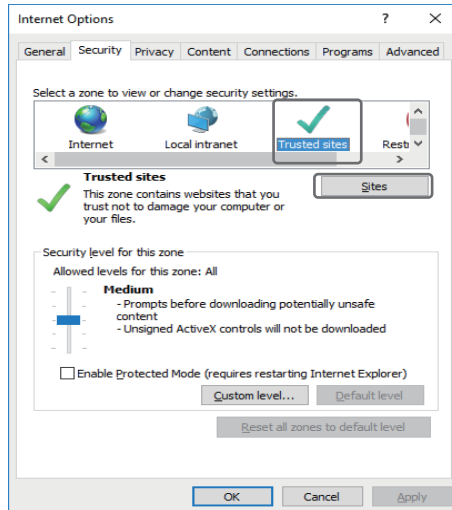

- (3) In the **Add this Web site to the zone** box, enter the IP address of the target Reader/Writer, and then click Add.

http: // "IP address of target device"

ex) http://192.168.1.200/

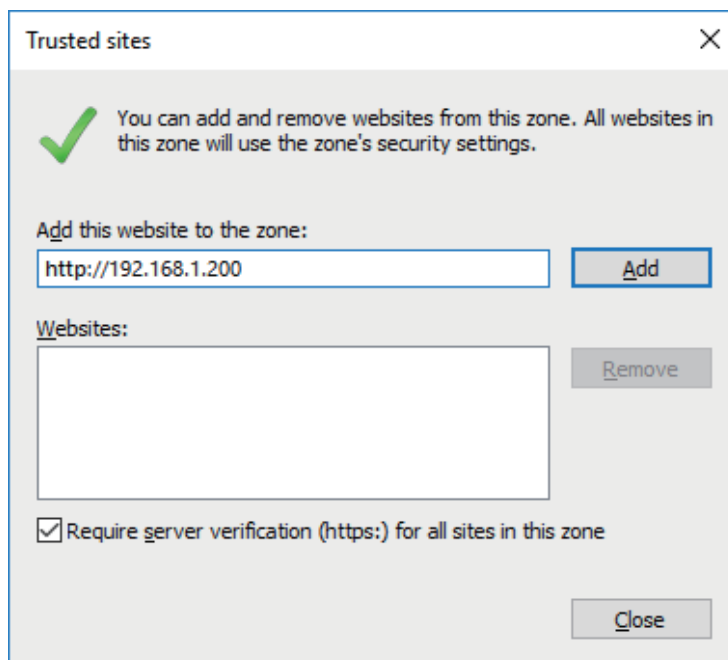

Countermeasures for Other Problems

(1) Open the Control Panel and click the **Java** Icon.

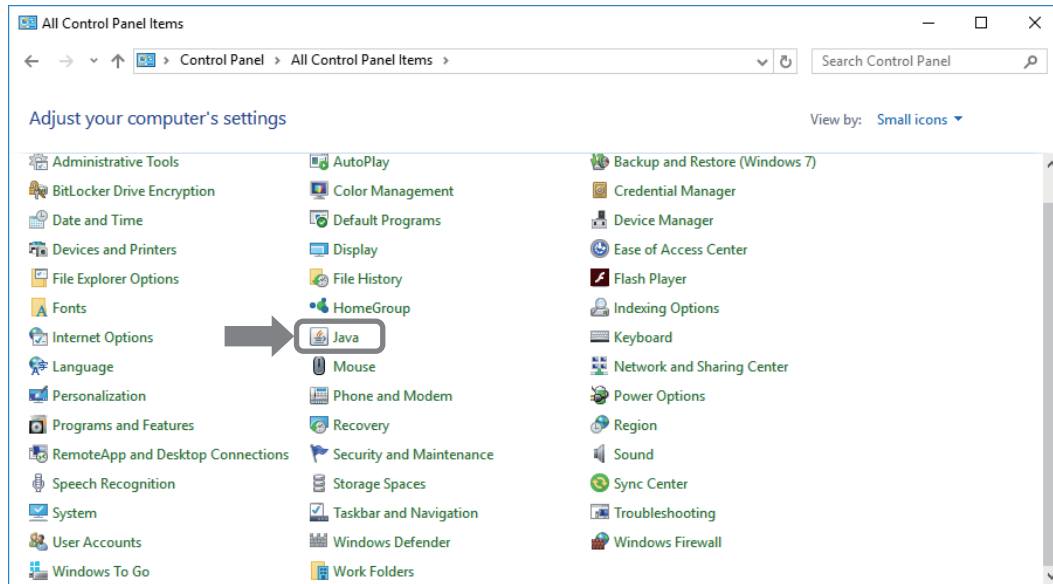

(2) Click the **Settings** Button in the **Temporary Internet Files** Area on the **General** Tab Page.

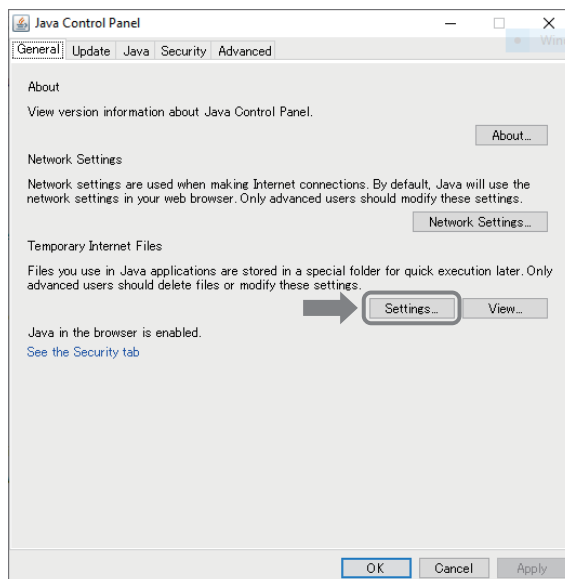

(3) Select the **Keep temporary files on my computer** Check Box and click the **Delete Files** Button.

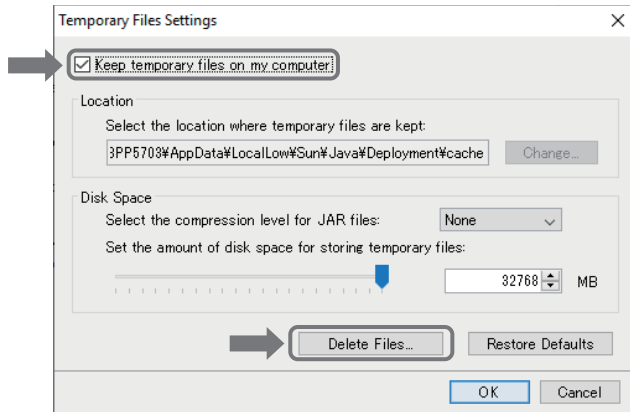

(4) Click the **OK** Button.

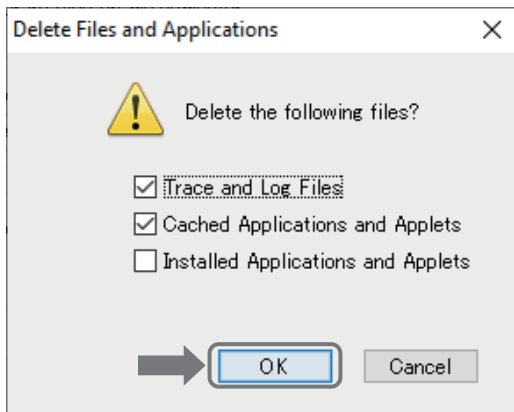

(5) When the files have been deleted, click the **OK** Button and close all windows. Then, restart the Web browser and connect to the Amplifier Unit again.



Index



Index

A

access password	6-27
advanced settings	8-10
Attachment	1-16, 4-4
Auto	6-9

B

basic settings	8-9
BOOTP server	5-5
browser interface	1-4, 8-1

C

channel	6-26
channel monitor	6-52, 8-23
CLEAR SYSTEM ERROR LOG	7-126
command error log	8-26
command errors	9-4
commands	7-19
communications commands	6-13
communications diagnostics	6-38
communications mode	6-6
Communications Range Extension Mode	6-58
configuration	8-33
configuration file	6-33, 8-39
configuration files	6-33
connectors	3-13
control signal	6-3

D

DATA FILL	6-16, 7-32
DATA READ	6-15, 7-26
DATA WRITE	6-15, 7-28
device settings	6-31, 8-13

E

EPC area	6-14
EPC Global Class1 Generation 2 standard	6-14
error code	9-4
error tables	9-4
exception code	7-7
expanded command	7-3
EXTENDED DATA READ	7-44
EXTENDED DATA WRITE	7-46
EXTENDED MULTIACCESS DATA READ	7-50
EXTENDED MULTIACCESS ID READ	7-48

F

Ferrite Cores	4-3
---------------------	-----

field length	7-5
firmware version	6-34
Focus	6-11
focus monitor	6-53, 8-24
function code	7-5

G

Gen2 session	6-27
general specifications	1-6
GET ACCESS PASSWORD	7-90
GET COMMAND ERROR LOG	7-127
GET COMMUNICATIONS DIAGNOSTIC INFORMATION .. 7-136	
GET DEVICE NAME	7-63
GET FIRMWARE VERSION	7-113
GET GEN2 SESSION	7-87
GET MAC ADDRESS	7-115
GET MODBUS/TCP COMMUNICATIONS CONDITIONS .. 7-66	
GET MODEL INFORMATION	7-111
GET MOST RECENT COMMAND ERROR INFORMATION .. 7-129	
GET MULTIACCESS DATA READ RESULTS	7-41
GET MULTIACCESS ID READ RESULTS	7-36
GET MULTI-READER/WRITE CONFIGURATION .. 7-109	
GET MULTI-READER/WRITE STATUS	7-122
GET NOISE LEVEL	7-133
GET OPERATING STATUS	7-116
GET OPERATION INDICATOR CUSTOM CONDITIONS ... 7-105,	7-109
GET RF TAG ADDITIONAL INFORMATION	7-131
GET RF TAG SELECTION FILTER CONDITIONS	7-93
GET RSSI FILTER CONDITIONS	7-97
GET SYSTEM ERROR LOG	7-124
GET TAG COMMUNICATIONS CONDITIONS	7-75
GET TCP/IP COMMUNICATIONS CONDITIONS	7-59
GET TIME INFORMATION	7-118
GET TRANSMISSION POWER	7-79
GET TRANSMISSION TIME	7-101
GET WEB COMMUNICATIONS CONDITIONS	7-69
GET WEB PASSWORD	7-72
getting and clearing the system error log	6-35
getting and setting time information	6-34
getting the command error log	6-36
getting the most recent command error information	6-36
getting the noise level	6-37
getting the operating status	6-34
getting the reception level	6-37

I

ID READ	6-15, 7-22
ID WRITE	6-16, 7-24
initialization	6-18

- INITIALIZE7-52
 installation location notification6-21
 IP addresses5-3
- L**
-
- LOCK 6-16, 7-30
 logs 8-26
- M**
-
- MAC address6-34
 maintenance (device information)6-34
 maintenance commands (device information)7-111
 maintenance commands (log information)7-124
 maintenance commands (RF communications information)
 7-131
 major faults9-6
 Master Reader/Writer 2-4, 6-56
 memory bank6-14
 minor faults9-6
 Modbus expansion communications commands7-44
 Modbus/TCP communications7-1
 multiaccess communications6-5
 multiaccess communications commands7-34
 MULTIACCESS DATA READ6-17
 MULTIACCESS ID READ6-17
 Multi-Reader/Writer Function6-56
 Multi-Reader/Writer Modes6-57
- N**
-
- network settings 6-22, 8-6
 normal commands7-3
- O**
-
- Once6-6
 operation indicator custom settings 6-31, 6-32, 8-13
 operation indicators3-2
 operation modes6-3
- P**
-
- Password Entry View8-4
 Port settings6-23
 port settings8-7
 protocol identifier7-5
- R**
-
- Reader/Writer4-2
 Reader/Writer control commands7-52
 Reader/Writer controls6-18
 Reader/Writer Number6-56
 Reader/Writer setting commands
 device settings7-103
 Reader/Writer setting commands (communications settings)
 7-73
 Reader/Writer setting commands (network settings)7-57
 Reader/Writer settings6-22
 reading device information6-34
 reception level monitor6-48, 8-20
 recommended power supply1-14
 RESET7-54
 RESET FOCUS6-20, 7-56
 resetting6-18
 RF communications command options7-10
 RF communications conditions (advanced settings)6-26
 RF communications conditions (basic settings)6-24
 RF communications diagnostics6-25
 RF communications diagnostics log8-28
 RF communications mode6-24
 RF communications settings8-9
 RF communications speed6-24
 RF communications timeout time6-24
 RF Tag access6-46, 8-17
 RF Tag communications6-4
 RF Tag communications errors9-5
 RF Tag scanning6-47, 8-19
 RF Tag selection filter6-30
 RF Tags1-15, 4-4
 RFID system configuration2-2
 RSSI filter6-29
 Run Mode6-3
- S**
-
- Safe Mode6-3
 SET ACCESS PASSWORD7-88
 SET DEVICE NAME7-61
 SET GEN2 SESSION7-85
 SET MODBUS/TCP COMMUNICATIONS CONDITIONS ...
 7-64
 SET MULTIACCESS DATA READ7-39
 SET MULTIACCESS ID READ7-34
 SET MULTI-READER/WRITEER CONFIGURATION ...7-107
 SET OPERATION INDICATOR CUSTOM CONDITIONS ...
 7-103
 SET RF TAG SELECTION FILTER CONDITIONS7-91
 SET RSSI FILTER CONDITIONS7-95
 SET TAG COMMUNICATIONS CONDITIONS7-73
 SET TCP/IP COMMUNICATIONS CONDITIONS7-57
 SET TIME INFORMATION7-120
 SET TRANSMISSION POWER7-77
 SET TRANSMISSION TIME7-99
 SET WEB COMMUNICATIONS CONDITIONS7-67
 SET WEB PASSWORD7-70
 single-access communications6-4
 single-access communications commands7-22
 SLAVE Mode3-11
 Slave Reader/Writer2-4, 6-32
 Standard Reader/Writer2-4
 Status View8-5
 STOP7-55
 stopping6-19
 system error log8-27
 system errors9-6

T

Tag Communications Specifications	1-8, 1-9, 1-10, 1-11, 1-12,	1-13
TCP/IP settings	6-22, 8-6	
TID area	6-14	
transaction identifier	7-5	
transmission power	6-26	
transmission power tuning	6-43, 8-15	
transmission time	6-28	
tuning	6-43, 8-15	
types of errors	9-2	

U

unit identifier	7-5
User area	6-14
utilities	6-46, 8-17

V

V780-A-JIME-Z3BLI-10	1-15
V780-A-TA-133-10	1-16

W

Web browser interface	1-4
Web password	6-23
Web password setting	8-8
write verification	6-25

OMRON Corporation Industrial Automation Company

Kyoto, JAPAN

Contact : www.ia.omron.com

Regional Headquarters

OMRON EUROPE B.V.

Wegalaan 67-69, 2132 JD Hoofddorp
The Netherlands
Tel: (31) 2356-81-300 Fax: (31) 2356-81-388

OMRON ELECTRONICS LLC

2895 Greenspoint Parkway, Suite 200
Hoffman Estates, IL 60169 U.S.A.
Tel: (1) 847-843-7900 Fax: (1) 847-843-7787

OMRON ASIA PACIFIC PTE. LTD.

438B Alexandra Road, #08-01/02 Alexandra
Technopark, Singapore 119968
Tel: (65) 6835-3011 Fax: (65) 6835-2711

OMRON (CHINA) CO., LTD.

Room 2211, Bank of China Tower,
200 Yin Cheng Zhong Road,
PuDong New Area, Shanghai, 200120, China
Tel: (86) 21-5037-2222 Fax: (86) 21-5037-2200

Authorized Distributor:

©OMRON Corporation 2017-2022 All Rights Reserved.
In the interest of product improvement,
specifications are subject to change without notice.

Cat. No. Z389-E1-12 0922 (0317)