

Smart Sensor

Data Storage Unit

ZS-DSU (Ver 2.0)

User's Manual

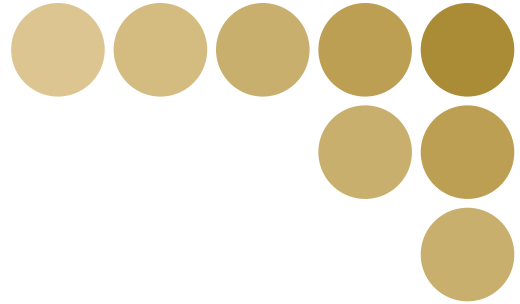

Data Storage Unit

Introduction

This manual provides information regarding functions, performance and operating methods that are required for using the ZS-DSU.

When using the ZS-DSU, be sure to observe the following:

- The ZS-DSU must be operated by personnel knowledgeable in electrical engineering.
- To ensure correct use, please read this manual thoroughly to deepen your understanding of the product.
- Please keep this manual in a safe place so that it can be referred to whenever necessary.

About Trademarks

- Microsoft and Windows are either registered trademarks or trademarks of Microsoft Corp. in the United States and/or other countries.
- CompactFlash is a trademark of SanDisk Corporation.
- Other product and company names herein may be either registered trademarks or trademarks of their respective owners.

■ How to Switch the Display Language to English

Turn the power ON with the MENU key held down. This displays the display language selection screen.



The Controller will start up with the messages displayed in English when it is next started up.

Introduction	APPLICATION CONSIDERATIONS (Please Read)	Introduction
Section 1	FEATURES	Section 1
Section 2	INSTALLATION & CONNECTION	Section 2
Section 3	SETUP	Section 3
Section 4	EXTERNAL I/O	Section 4
Section 5	APPLICATION SETTING EXAMPLES	Section 5
Section 6	APPENDIX	Section 6

User's Manual

Smart Sensor
Data Storage Unit

ZS-DSU

READ AND UNDERSTAND THIS DOCUMENT

Please read and understand this document before using the products. Please consult your OMRON representative if you have any questions or comments.

WARRANTY

OMRON's exclusive warranty is that the products are free from defects in materials and workmanship for a period of one year (or other period if specified) from date of sale by OMRON.

OMRON MAKES NO WARRANTY OR REPRESENTATION, EXPRESS OR IMPLIED, REGARDING NON-INFRINGEMENT, MERCHANTABILITY, OR FITNESS FOR PARTICULAR PURPOSE OF THE PRODUCTS. ANY BUYER OR USER ACKNOWLEDGES THAT THE BUYER OR USER ALONE HAS DETERMINED THAT THE PRODUCTS WILL SUITABLY MEET THE REQUIREMENTS OF THEIR INTENDED USE. OMRON DISCLAIMS ALL OTHER WARRANTIES, EXPRESS OR IMPLIED.

LIMITATIONS OF LIABILITY

OMRON SHALL NOT BE RESPONSIBLE FOR SPECIAL, INDIRECT, OR CONSEQUENTIAL DAMAGES, LOSS OF PROFITS OR COMMERCIAL LOSS IN ANY WAY CONNECTED WITH THE PRODUCTS, WHETHER SUCH CLAIM IS BASED ON CONTRACT, WARRANTY, NEGLIGENCE, OR STRICT LIABILITY.

In no event shall responsibility of OMRON for any act exceed the individual price of the product on which liability is asserted.

IN NO EVENT SHALL OMRON BE RESPONSIBLE FOR WARRANTY, REPAIR, OR OTHER CLAIMS REGARDING THE PRODUCTS UNLESS OMRON'S ANALYSIS CONFIRMS THAT THE PRODUCTS WERE PROPERLY HANDLED, STORED, INSTALLED, AND MAINTAINED AND NOT SUBJECT TO CONTAMINATION, ABUSE, MISUSE, OR INAPPROPRIATE MODIFICATION OR REPAIR.

SUITABILITY FOR USE

THE PRODUCTS CONTAINED IN THIS DOCUMENT ARE NOT SAFETY RATED. THEY ARE NOT DESIGNED OR RATED FOR ENSURING SAFETY OF PERSONS, AND SHOULD NOT BE RELIED UPON AS A SAFETY COMPONENT OR PROTECTIVE DEVICE FOR SUCH PURPOSES.

Please refer to separate catalogs for OMRON's safety rated products.

OMRON shall not be responsible for conformity with any standards, codes, or regulations that apply to the combination of products in the customer's application or use of the product.

At the customer's request, OMRON will provide applicable third party certification documents identifying ratings and limitations of use that apply to the products. This information by itself is not sufficient for a complete determination of the suitability of the products in combination with the end product, machine, system, or other application or use.

The following are some examples of applications for which particular attention must be given. This is not intended to be an exhaustive list of all possible uses of the products, nor is it intended to imply that the uses listed may be suitable for the products:

- Outdoor use, uses involving potential chemical contamination or electrical interference, or conditions or uses not described in this document.
- Nuclear energy control systems, combustion systems, railroad systems, aviation systems, medical equipment, amusement machines, vehicles, safety equipment, and installations subject to separate industry or government regulations.
- Systems, machines, and equipment that could present a risk to life or property.

Please know and observe all prohibitions of use applicable to the products.

NEVER USE THE PRODUCTS FOR AN APPLICATION INVOLVING SERIOUS RISK TO LIFE OR PROPERTY WITHOUT ENSURING THAT THE SYSTEM AS A WHOLE HAS BEEN DESIGNED TO ADDRESS THE RISKS, AND THAT THE OMRON PRODUCT IS PROPERLY RATED AND INSTALLED FOR THE INTENDED USE WITHIN THE OVERALL EQUIPMENT OR SYSTEM.

PERFORMANCE DATA

Performance data given in this document is provided as a guide for the user in determining suitability and does not constitute a warranty. It may represent the result of OMRON's test conditions, and the users must correlate it to actual application requirements. Actual performance is subject to the OMRON Warranty and Limitations of Liability.

CHANGE IN SPECIFICATIONS

Product specifications and accessories may be changed at any time based on improvements and other reasons.

It is our practice to change model numbers when published ratings or features are changed, or when significant construction changes are made. However, some specifications of the product may be changed without any notice. When in doubt, special model numbers may be assigned to fix or establish key specifications for your application on your request. Please consult with your OMRON representative at any time to confirm actual specifications of purchased products.

DIMENSIONS AND WEIGHTS

Dimensions and weights are nominal and are not to be used for manufacturing purposes, even when tolerances are shown.

ERRORS AND OMISSIONS

The information in this document has been carefully checked and is believed to be accurate; however, no responsibility is assumed for clerical, typographical, or proofreading errors, or omissions.

PROGRAMMABLE PRODUCTS

OMRON shall not be responsible for the user's programming of a programmable product, or any consequence thereof.

COPYRIGHT AND COPY PERMISSION

This document shall not be copied for sales or promotions without permission.

This document is protected by copyright and is intended solely for use in conjunction with the product. Please notify us before copying or reproducing this document in any manner, for any other purpose. If copying or transmitting this document to another, please copy or transmit it in its entirety.

Meanings of Signal Words

The following signal words are used in this manual.



Indicates a potentially hazardous situation which, if not avoided, will result in minor or moderate injury, or may result in serious injury or death. Additionally there may be significant property damage.

Meanings of Alert Symbols

The following alert symbols are used in this manual.



Indicates the possibility of explosion under specific conditions.

Alert statements in this Manual

The following alert statements apply to the products in this manual. Each alert statement also appears at the locations needed in this manual to attract your attention.



The Data Storage Unit has a built-in lithium battery, which may ignite or rupture and cause serious injury in rare instances.
Do not disassemble, deform by pressure, and heat or incinerate this Unit to temperatures exceeding 100°C.



Precautions for Safe Use

Please observe the following precautions for safe use of the products.

(1) Installation Environment

- Do not use the product in environments where it can be exposed to inflammable/explosive gas.
- To secure the safety of operation and maintenance, do not install the product close to high-voltage devices and power devices.

(2) Power Supply and Wiring

- The supply voltage must be within the rated range (DC24V±10%).
- Reverse connection of the power supply is not allowed.
- Open-collector outputs should not be short-circuited.
- Use the power supply within the rated load.
- High-voltage lines and power lines must be wired separately from this product. Wiring them together or placing them in the same duct may cause induction, resulting in malfunction or damage.

(3) Regulations and Standards

- EN61326-1
- Electromagnetic environment : Industrial electromagnetic environment (EN/IEC 61326-1 Table 2)
- Notice for Korea Radio Law
A 급 기기 (업무용 방송통신기자재)
이 기기는 업무용 (A 급) 전자파적합기기로서 판매자 또는 사용자는 이 점을 주의하시기 바라며 , 가정외의 지역에서 사용하는 것을 목적으로 합니다.

(4) Others

- Do not attempt to dismantle, repair, or modify the product.
- Dispose of this product as industrial waste.

Precautions for Correct Use

Please observe the following precautions to prevent failure to operate, malfunctions, or undesirable effects on product performance.

(1) Installation Site

Do not install the product in locations subjected to the following conditions:

- Ambient temperature outside the rating
- Rapid temperature fluctuations (causing condensation)
- Relative humidity outside the range of 35 to 85%
- Presence of corrosive or flammable gases
- Presence of dust, salt, or iron particles
- Direct vibration or shock
- Reflection of intense light (such as other laser beams or electric arc-welding machines)
- Direct sunlight or near heaters
- Water, oil, or chemical fumes or spray
- Strong magnetic or electric field

(2) Power Supply and Wiring

- When using a commercially available switching regulator, make sure that the FG terminal is grounded.
- If surge currents are present in the power lines, connect surge absorbers that suit the operating environment.
- Before turning ON the power after the product is connected, make sure that the power supply voltage is correct, there are no incorrect connections (e.g. load short-circuit) and the load current is appropriate. Incorrect wiring may result in breakdown of the product.
- Before connecting/disconnecting the Peripheral device, make sure that the Multi-Controller is turned OFF. The Multi-Controller may break down if the Peripheral device is connected or disconnected while the power is ON.
- Use only combinations Sensor Controllers or Multi-Controllers specified in this manual.

(3) Orientation when Installing the Data Storage Unit

To improve heat radiation, install the Data Storage Unit only in the orientation shown below.

Right

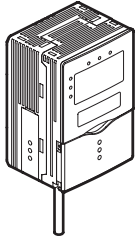

Do not install the Data Storage Unit in the following

Wrong

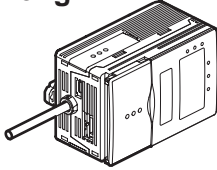

Wrong

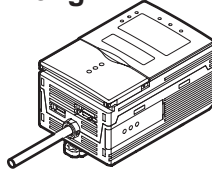

(4) Maintenance and Inspection

Do not use thinner, benzene, acetone or kerosene to clean the Data Storage Unit.

Editor's Note

Page Format

Title of each section

Header

Overview

Cross-header

Overview of the cross-header

Movement through menus up to setting items

Index label
Indicates the section number and title.

Explanation of options

Section3
Setting the Logging Conditions

Setting the Logging Conditions

Set the conditions for logging data. ←

Source settings ←

Assign the controller or data to be logged as the source. ←

▶ FUN Mode-[LOGING]-[SOURCE]-[SourceA to J] ←

Setting	Description
SELECT	Assigns a CH No. or data as the selected source. When the Data Storage Unit is connected to the ZS-LDC, only the CH selection is displayed. When the Data Storage Unit is connected to the ZS-MDC, only the data selection is displayed.
CH	Assigns the CH No. of the ZS-LDC to be logged. Range: None, 1CH onwards (largest gang-mounted CH)
DATA	Assigns the data of the ZS-MDC to be logged. Range: TASK1 to TASK4, Input A to Input I
SAVE	Set this item to ON to save logged data. Set this item to OFF in the case of sources that are used solely as logging triggers. Range: OFF, ON (default value: OFF)
LABEL	Sets the label for the logging data. • Call up the initial character of each character group using function keys 1 to 4. (Other signals are assigned to the latter half of each group.) 1: A to Z 2: a to z 3: KANA 4: Numbers, ., /, <, =, >, ? , @ • Switch the characters in order using the UP or DOWN key. • Move the digits by the LEFT or RIGHT key. • To clear a character, select a space.

Section 3
SETUP

ZS-DSU
User's Manual

3-15

Supplementary Explanation

Helpful information regarding operation and reference pages are introduced here using symbols.



CHECK!

*This page has been made purely for explanatory purposes and does not exist.

■ Meaning of Symbols

Menu items that are displayed on the Data Storage Unit LCD screen, and windows, dialog boxes and other GUI elements displayed on the PC are indicated enclosed by brackets [].

■ Visual Aids



Indicates points that are important to ensure full product performance, such as operational precautions and application procedures.

CHECK!



Indicates pages where related information can be found.



Indicates information helpful in operation.

CONTENTS

Meanings of Signal Words	5
Meanings of Alert Symbols	5
Alert statements in this Manual	5
Precautions for Safe Use	6
Precautions for Correct Use	7
Editor's Note	9
Page Format	9
CONTENTS	11
<hr/>	
Section 1 FEATURES	1-1
<hr/>	
Features of the Data Storage Unit	1-2
Data Storage Unit Capabilities	1-4
Logging Functions	1-4
External Bank Function	1-8
Alarm Output Function	1-8
Basic Configuration	1-9
Part Names and Functions	1-12
Brief Description of Logging Function	1-14
How logging works	1-14
Sampling interval at image logging ON/OFF	1-14
System configuration and logging operations	1-15
Format of Data Logged on Memory Card	1-16
File configuration in memory card	1-16
<hr/>	
Section 2 INSTALLATION & CONNECTION	2-1
<hr/>	
About Installation and Connection	2-2
Data Storage Unit	2-3
Attaching the ferrite core	2-3
Installing the Data Storage Unit	2-4
Gang-mounted with Logging Target Controller	2-9
About the I/O cable	2-11
How to Insert and Remove the Memory Card	2-15
<hr/>	

Section 3 SETUP	3-1
Setting Flow	3-2
About Setup	3-4
Basic Knowledge for Operation	3-4
List of Setting Items	3-11
Setting the Logging Conditions	3-15
Source settings	3-15
Setting the start trigger	3-16
Setting the end trigger	3-21
Sampling Settings	3-26
Setting the Data Format	3-31
Setting Banks	3-33
Switching banks	3-33
Clearing banks	3-33
External Bank Function	3-34
Setting the System Environment	3-35
Ejecting the Memory Card	3-35
Saving setup data	3-35
Initializing setup data	3-36
Checking system information	3-36
Setting the System Clock	3-36
Initializing the Memory Card	3-37
Setting the save start No.	3-37
Setting key lock	3-37
Setting the display language	3-38
Setting the Display Method	3-39
Setting the display	3-39
Setting the LCD display	3-40
HELP	3-41
Section 4 EXTERNAL I/O	4-1
Alarm Output	4-2
Selecting the Measurement Data Source	4-2
Setting Judgment Conditions	4-3

RS-232C Input/Output	4-4
RS-232C Specifications	4-4
Setting the Communication Specifications	4-5
Section 5 APPLICATION SETTING EXAMPLES	5-1
Periodic Continuous Logging	5-2
Multi-point Simultaneous Logging	5-5
Logging the Shape for Each Detected Workpiece	5-8
Simultaneous Logging Images and Measured Values for Multiple Controllers	5-11
Save NG Images for 1 Day	5-14
Logging of Images Before and After NG	5-16
Section 6 APPENDIX	6-1
Troubleshooting	6-2
Error Messages and Countermeasures	6-3
Q&A	6-4
Glossary	6-4
Specifications and External Dimensions	6-5
Data Storage Unit	6-5
Panel Mount Adapters	6-7
RS-232C Cable for Connecting to a Personal Computer	6-8
Controller Link Unit	6-9
Version Up Information	6-10
INDEX	6-11
Revision History	6-16

MEMO

Section 1

FEATURES

☒ Features of the Data Storage Unit	1-2
☒ Data Storage Unit Capabilities	1-4
Logging Functions	1-4
External Bank Function	1-8
Alarm Output Function	1-8
☒ Basic Configuration	1-9
☒ Part Names and Functions	1-12
☒ Brief Description of Logging Function	1-14
How logging works	1-14
Sampling interval at image logging ON/OFF	1-14
System configuration and logging operations	1-15
Format of Data Logged on Memory Card	1-16
File configuration in memory card	1-16

Features of the Data Storage Unit

The Data Storage Unit is an exclusive data collection unit. It gets measurement and image data and from ZS and ZFV Series Controllers while they are still installed at the site, and saves that data to Memory Card (CompactFlash). The Data Storage Unit shares the high reliability of the ZS Series, and reliably collects data from on-site devices through simple and high-speed operation. Data saved on Memory Card can be easily loaded to a personal computer so that collected data can be easily analyzed and operated on.



The smart sensor series that can be connected include ZS-LDC, ZS-MDC and ZFV. These 3 target items are generically labeled as "controller" in this manual.

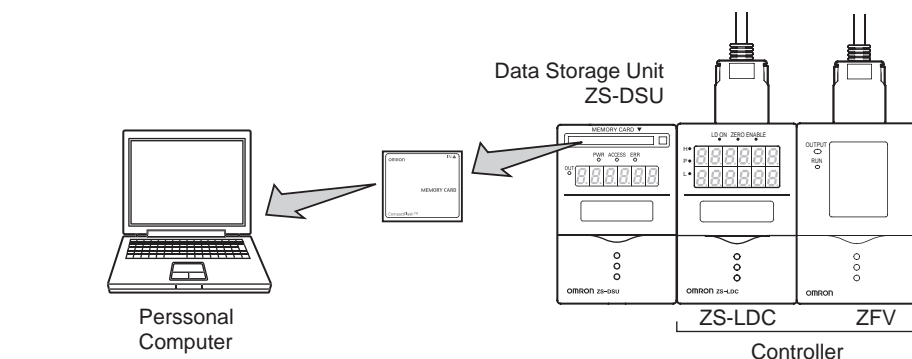

(1) Enables image data logging

When ZFV is connected, images and measured data can be logged together. A maximum 128 images can be acquired continuously, achieving full image logging combined with various logging trigger functions.

(2) Optimum Data Logging

A wide range of logging trigger functions are available, allowing you to save only the valid data you require out of the immense volume of data during operation.

Example:

- External input-driven trigger
- Button entry-driven trigger
- Measurement value change-driven self trigger
- Judgment value-driven trigger
- Time-driven trigger

In addition, when logging images from the ZFV, the following 2 logging conditions can be selected.

- Save all logged image and measured data
- Save only NG judgment results from logged image and measured data

(3) Logging of Multi-point Controller Information and Calculation Information Supported

Data can be collected from up to 15 Controllers. Calculation result data can also be collected linked to the Multi-Controller.

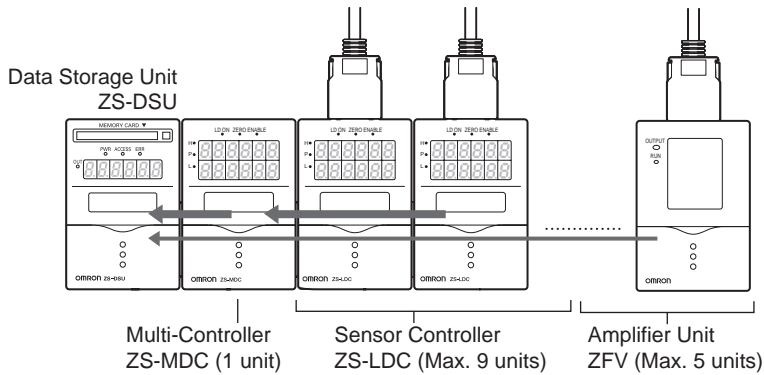

When a Multi-Controller is connected, it is set only to measured value logging. ZFV image data cannot be logged.

CHECK!



Installing the Data Storage Unit p.2-4

(4) USB Connection

The Data Storage Unit is provided with a USB port (compliant with Full-Speed USB2.0 specifications) as standard. Use the Omron CompoWay/F communications protocol or no control sequence to change Data Storage Unit settings from a PC or other external device, and acquire data within a memory card.

For details on command formats, refer to the “Communication Command Reference” (provided separately).

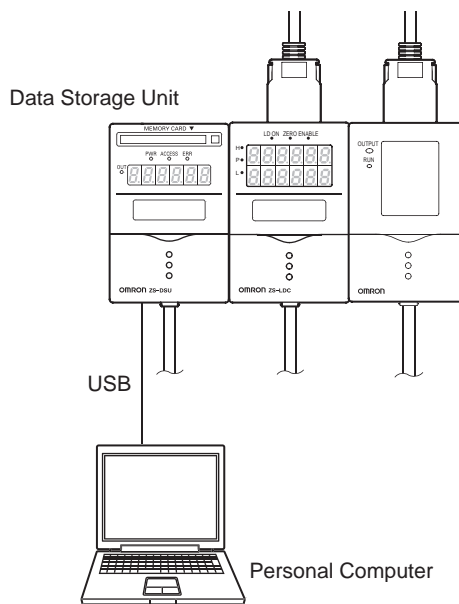

Data Storage Unit Capabilities

Logging Functions

● Data can be collected whenever you want.

Data can be collected at any timing or by trigger conditions.

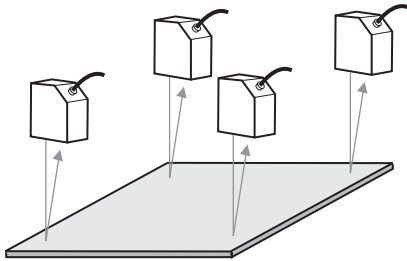

<by external input>

Measured values when the workpiece is at the specified position are batch-acquired.

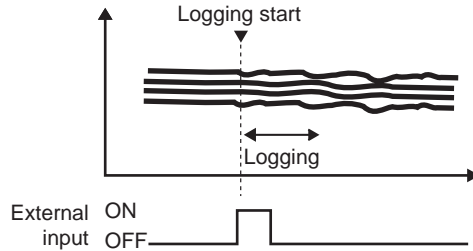

<by button input>

Measured values in a certain period are acquired continuously.

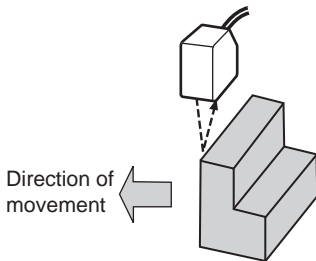
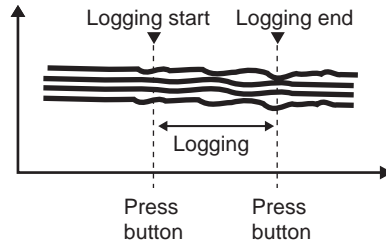

<self trigger by change in state of measured value>

The data of a period, during which the measured values of the workpiece are at a specified value or less (or more), is acquired continuously.

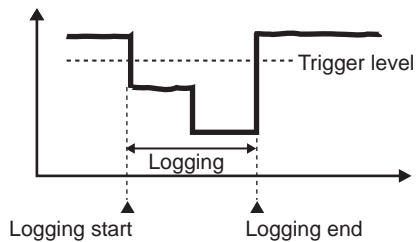

● Images can be logged (only when ZFV is connected)

Image data and corresponding measured value data can be logged simultaneously. Image data and measured value data is associated and saved using ID numbers, which simplifies data verification later when analyzing.



CHECK!

- Only amplifier units with a sensor head connected (ZFV) can acquire image data. When an amplifier unit with a sensor head connected is 2CH, only one of these CHs can log images. When logging multiple CHs, set the logging target CH with ZS-DSU bank settings, and switch the bank for use.
- When gang-mounted to a Multi-Controller, only measured value data is calculated, thus image data cannot be logged.

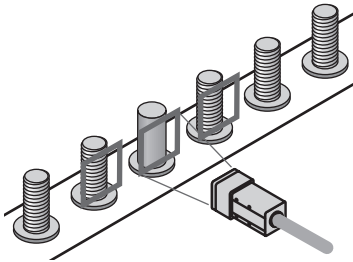

<Continuous image data acquisition>
Continuous acquisition of maximum 128
workpiece images on the line.

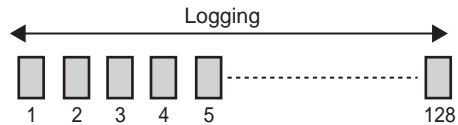

● NGs can be logged to the trigger.

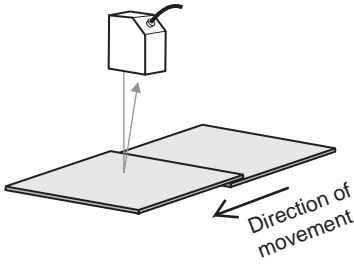

<by judgment result>
Measured values when the measured values of the workpiece exceed (or fall below) a specific level are acquired.

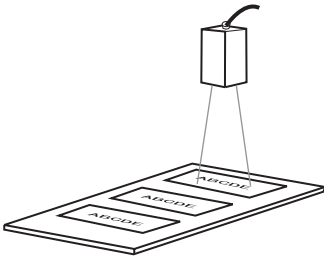
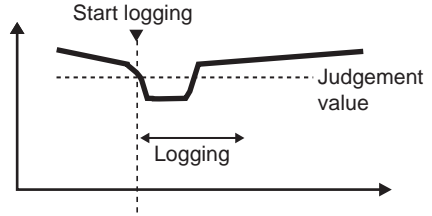

<At Save NG>
Acquiring image data when workpiece pattern alignment is judged NG

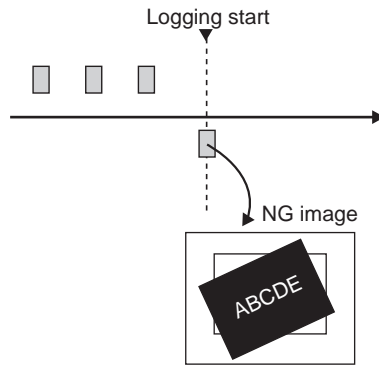

A delay or number of delays can be set to the logging start trigger. For example, in the case of logging by judgment result, the data before a defect (NG) occurred can be saved by setting a minus delay or number of delays.

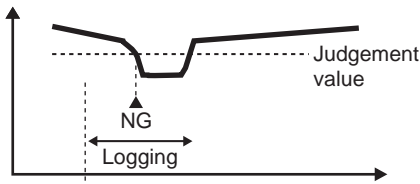

Logging is started back from before the NG was generated.

● **High-speed logging/extended logging can be selected. (ZS series only)**

The Data Storage Unit allows you to adapt to instances where you may want to confirm whether data has been saved and detected correctly at high speed, for example, in test verifications, or where you may want to collect data periodically over an extended period for quality assurance reasons.

To save data at high speed, use the “one-shot mode”.



Sampling settings (one-shot mode) p.3-26

To log data over an extended period, use the “repeat mode”.



Sampling settings (repeat mode) p.3-26



CHECK!

When image logging ON, operate in one-shot mode. However, sampling is executed for measurement cycle of logging target CH (ZFV), thus intervals cannot be set.

● **Logging data can be easily analyzed.**

The Data Storage Unit is bundled with analysis software with programmed Excel macros. This software is useful in performing analyses after logging data is imported to a personal computer.

● **Logging data can be collected in an easily manageable format.**

Logging data can be converted to the manageable CSV format by the CSV file conversion software, “CSV file converter for Data Storage Unit”, that is bundled with the Data Storage Unit. This software allows you collect and save data in an easy-to-see format as you can label collected data or reorganize it by line feed codes.

Times	Label A	Label B	Label C
1	*****	*****	*****
2	*****	*****	*****
3	*****	*****	*****

External Bank Function

- **Max. 128 sets of bank data can be saved on Memory Card.**

Data can be transferred to gang-mounted controllers whenever needed during rescheduling.

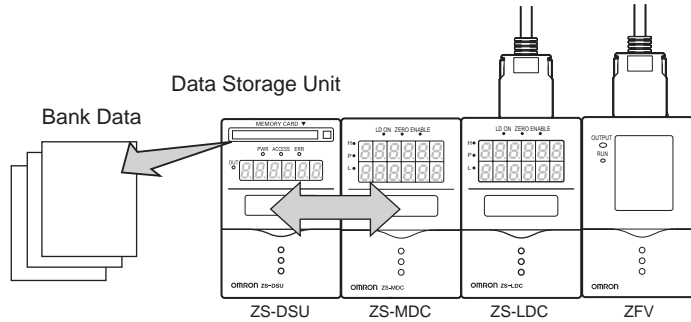

Alarm Output Function

- **Threshold values can be set to logged data.**

Threshold values can be output as alarms (HH/LL) from the Data Storage Unit in addition to controller judgment output.

Basic Configuration

The figure below shows the Basic Configuration of the ZS-DSU.

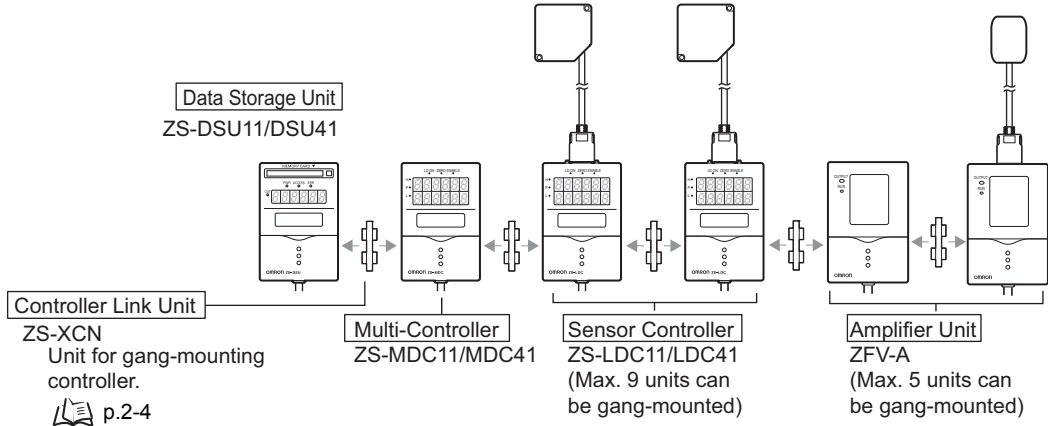

CHECK!

- Max. 15 controllers (ZS-DSU: 1 unit, ZS-MDC: 1 unit, ZS-LDC: 9 units, ZFV: 5 units) can be gang-mounted.
- When a multi-controller is connected, image data cannot be logged.
- When ZFV and ZS series are connected, check that software from the following version onward is installed.

Model	Ver.
ZFV	2.000
ZS-LDC	2.100
ZS-MDC	2.100
ZS-DSU	2.000

Memory Card



Recommended parts

Model	Capacity
HMC-EF283	256Mbyte
HMC-EF583	512Mbyte

Collection of tools for Data Storage Unit (A CD-ROM attached to ZS-DSU11/41)



- CSV File Converter for Data storage Unit (CSV file conversion software)
- Smart Analyzer Macro Edition (Excel macro for analyzing acquired data)

Power supply



DC24V ($\pm 10\%$)

Recommended parts

- (1) When 1 Sensor Controller is connected
S82K-01524 (DC24V, 0.6 A)
- (2) When 2 or 3 Sensor Controllers are connected
S82K-05024 (DC24V, 2.1 A)
- (3) When 4 to 15 Sensor Controllers are connected
Prepare the required number of (1) and (2) power supplies above.

■ Application expansion configuration

ZS-DSU can support a wide range of data logging needs in combination with ZS-MDC, ZS-LDC and ZFV.

● Measured value logging system configuration

- When only measured value is acquired
Log measured values of each connected controller.

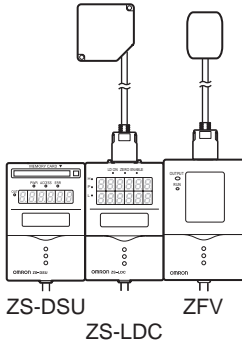

- When measured value calculation results are acquired
Connect the ZS-MDC, and log measured value results of each controller.

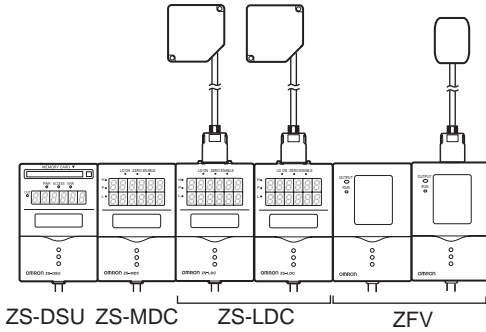

When ZS-MDC is connected, images cannot be logged.

● Image + measured value logging system configuration



When images are logged, ZS-MDC cannot be connected.

CHECK!

- When acquired from ZFV
Log image data and measured values from connected ZFV.

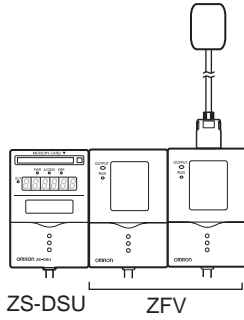

- When ZFV and ZS-LDC are connected
Log image data and their measured values from ZFV, as well as measured value from ZS-LDC.

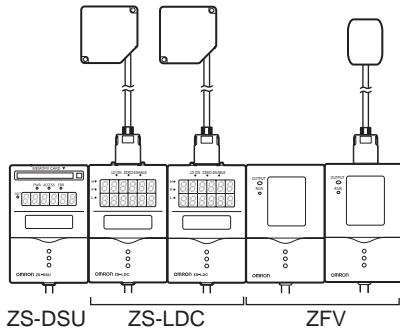

Part Names and Functions

The following describes the names and functions of parts on the Data Storage Unit.

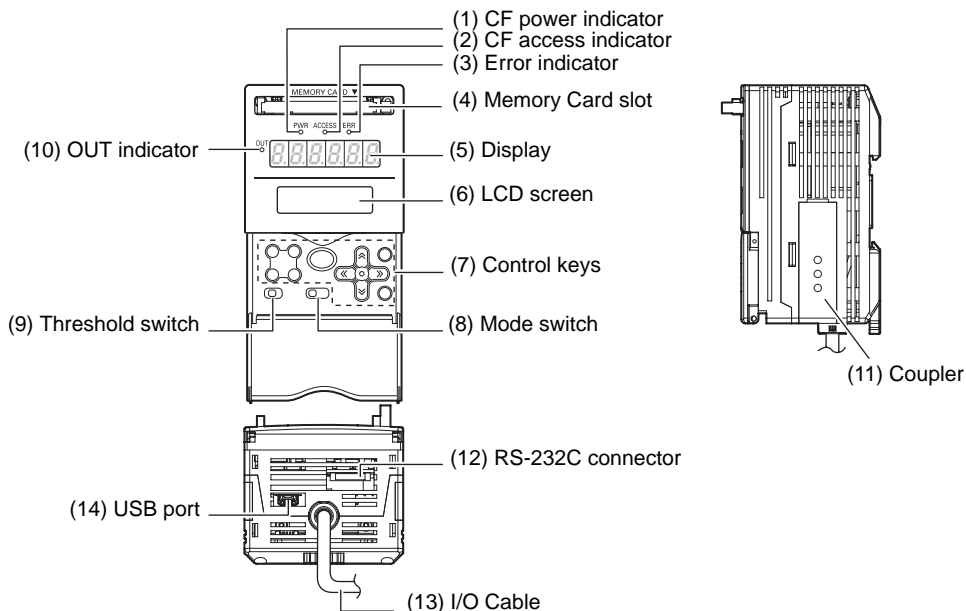

(1) CF power indicator

Indicates that power is being supplied to the Memory Card. Lits when power is ON and is out when power is OFF.

(2) CF access indicator

Lits when the Memory Card is being accessed.

(3) Error indicator

This indicator lits when there is a Memory Card read/write error.

(4) Memory Card slot

Insert the Memory Card into this slot.

(5) Display

Displays measured values during logging and remaining free space on the Memory Card, for example.



p.3-8

(6) LCD screen

RUN mode : Displays the content of the main display and the setup menu for display related information. The external bank function also is set up in this mode.

TEACH mode : Displays the threshold setup menu for the alarm outputs.

FUN mode : Displays the logging condition setup menu.

(7) Control keys

The Control Keys are for setting logging conditions and other information. The functions assigned to the Control Keys change according to the operating mode.



Displays and Key Operations p.3-5

(8) Mode Switch

The Mode Switch selects the operating mode.

RUN mode : Select this mode when performing regular logging.

TEACH mode : Select this mode when setting the judgment thresholds for alarm output.

FUN mode : Select this mode when setting logging conditions.

(9) Threshold Selector Switch

The Threshold Selector switch selects whether to set (or display) the HIGH or LOW threshold.

(10) OUT indicator

Lits during alarm output

(11) Coupler

This connector is for connecting the Multi-Controller or the Sensor Controller.

(12) RS-232C connector

Connect the RS-232 cable when you are connecting the Data Storage Unit to a personal computer that does not have a USB port.

(13) I/O Cable

The I/O cable connects the Data Storage Unit to the power supply and external devices, such as timing sensors or programmable controllers.

(14) USB port

Connect the USB cable to the USB port to connect to a personal computer.

Brief Description of Logging Function

How logging works

The following illustrates how data is logged on the ZS-DSU:

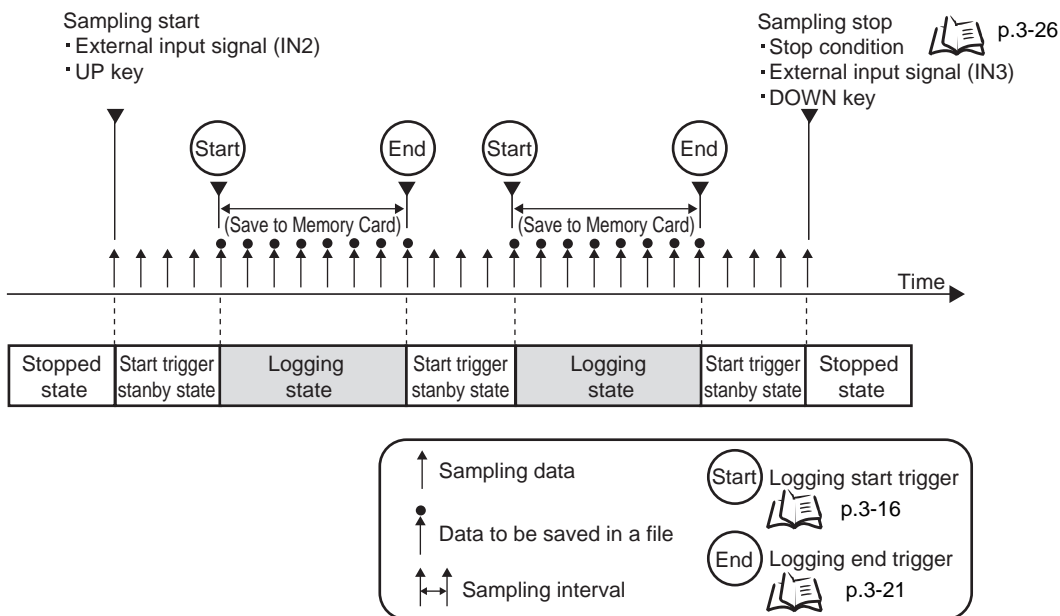

Sampling interval at image logging ON/OFF

When ZFV is connected, the measured value sampling interval varies according to ON/OFF.

Operations at image logging ON

Sampling is executed at the measurement cycle of image logging target CH (ZFV) in order to log images and measured values at the same timing. In ZS-DSU, synchronize to timing which image data is transferred at, and acquire measured value from logging target CH.



At image logging ON, image data inputs from ZFV are set to logging timing, thus the ZS-DSU cycle display ([SYSTEM] - [DATA] - [CYCLE]) is set to "- - - - -" (undefined).

■ Operations at image logging OFF

Execute sampling at sampling interval set with ZS-DSU. ZFV measured values are also acquired at this timing.



Sampling is executed at the interval set with ZS-DSU at image logging OFF, even when ZFV is connected. Note that this does not depend on the ZFV measurement cycle.

System configuration and logging operations

Logging targets and sampling intervals based on system configuration at gang-mounting as shown in the following table.

Controller to be connected			Logging target	Sampling Interval
ZS-MDC	ZS-LDC	ZFV		
No	Yes	No	ZS-LDC measured value	Sampling interval set with ZS-DSU
No	No	Yes	ZFV image data and measured value	Measurement cycle set with ZFV
			ZFV measured value	Sampling interval set with ZS-DSU
No	Yes	Yes	ZS-LDC measured value	Sampling interval set with ZS-DSU
			ZFV image data and measured value, ZS-LDC measured value	Measurement cycle set with ZFV
			ZFV measured value	Sampling interval set with ZS-DSU
Yes	Yes	No	Results where ZS-LDC measured values are calculated with ZS-MDC	Sampling interval set with ZS-DSU
Yes	No	Yes	Results where ZFV measured values are calculated with ZS-MDC	Sampling interval set with ZS-DSU
Yes	Yes	Yes	Results where ZS-LDC measured values are calculated with ZS-MDC	Sampling interval set with ZS-DSU
			Results where ZFV measured values are calculated with ZS-MDC	



When ZS-MDC is used to log calculation results, images from ZFV cannot be logged.

Format of Data Logged on Memory Card

Logging data is saved on Memory Card in a proprietary binary file format (extender .log) to increase data writing speed.

So that this logged data can be browsed on a personal computer, convert the data to CSV file using the PC-based conversion software, "CSV file converter for Data Storage Unit", bundled with the Data Storage Unit.

A CSV file is a text format file in which data is delimited by commas ",",

File configuration in memory card

Image data stored in the memory card is set to a bit map format file (.bmp).

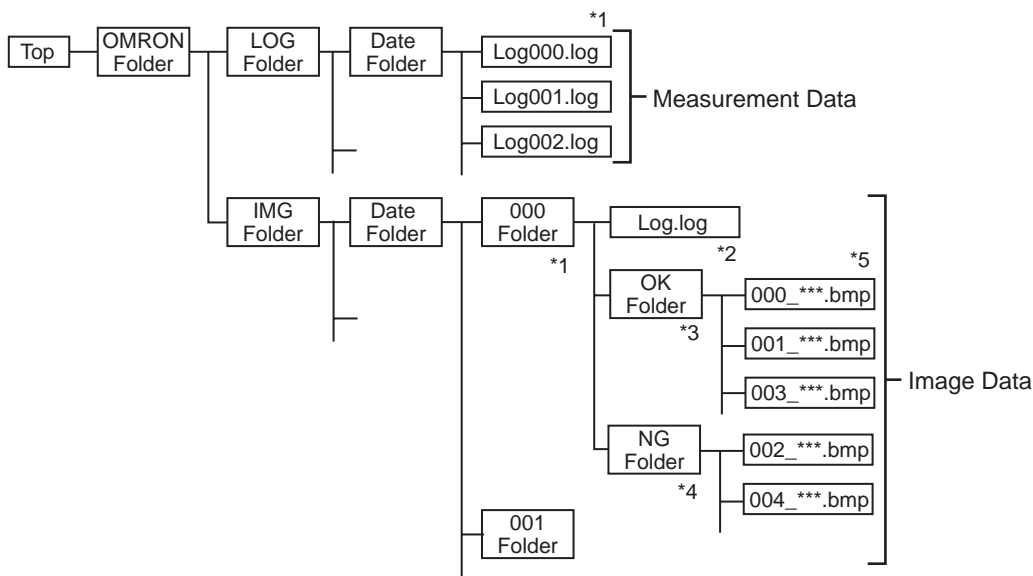

*1: A folder is created whenever start trigger - end trigger of logging trigger conditions are satisfied.

*2: Measurement result

*3: Folder where image data judged OK is saved

*4: Folder where image data judged NG is saved

*5: Image data file. The file name becomes as follows.

- When judged OK: Serial number _ date _ time_OK.bmp

- When judged NG: Serial number _ date _ time_NG.bmp

Example: When 003_041101_170921_OK.bmp

Measurement image when judged OK, created at 5:09:21pm on
November 1, 2004

(After logging starts, results for Item 4)



OK and NG judgments are made based on conditions set in [Logging] - [Sample] - [Save NG].

The default is judged with OR of judgment results of all logging target CHs; i.e., images are stored in the NG folder when one of the target CHs are judged NG. When ZS-LDC becomes the logging target CH, everything other than PASS is judged NG.

Section 2

INSTALLATION & CONNECTION

☒	About Installation and Connection	2-2
☒	Data Storage Unit	2-3
	Attaching the ferrite core	2-3
	Installing the Data Storage Unit	2-4
	Gang-mounted with Logging Target Controller	2-9
☒	About the I/O cable	2-11
☒	How to Insert and Remove the Memory Card	2-15

About Installation and Connection

■ Checking the installation environment

Read "Precautions for Safe Use" at the beginning of this manual, and check the installation environment.

■ Checking the installation site

Read "Precautions for Correct Use" at the beginning of this manual, and check the installation site.

■ About the power supply

Before installing and connecting the Data Storage Unit, be sure to turn it OFF. Also read "Precautions for Safe Use" and "Precautions for Correct Use" at the beginning of this manual, and check the power supply and wiring.

Data Storage Unit

This section describes installation of the Data Storage Unit, and connection of the I/O cable.



Before connecting/disconnecting peripheral devices, make sure that the Data Storage Unit is turned OFF. The Data Storage Unit may break down if it is connected or disconnected while the power is ON.

CHECK!

Attaching the ferrite core

Attach the ferrite core (provided with the Data Storage Unit) to the I/O cable of the Data Storage Unit.

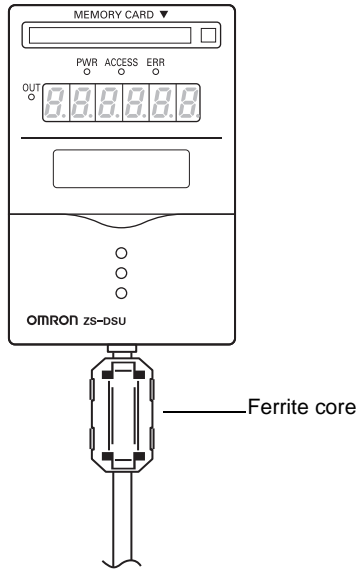

Installing the Data Storage Unit

■ Installing on the DIN track

The following describes how to attach the 35mm wide DIN track by quick, easy operation.

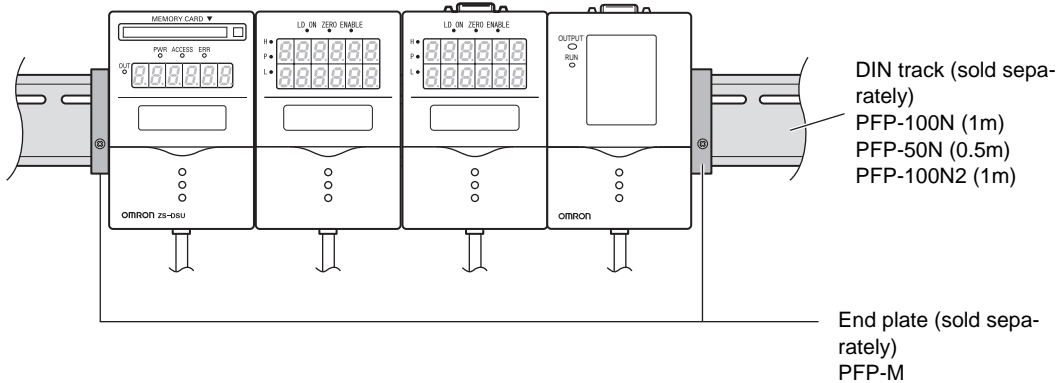

● Installation procedure

The following describes how to install the Data Storage Unit and controllers on the DIN track.

1. Hook the connector end of the device onto the DIN track.

2. Push the device down onto the DIN track until the hook on the I/O cable side is locked.

Push down until you hear it snap into place.

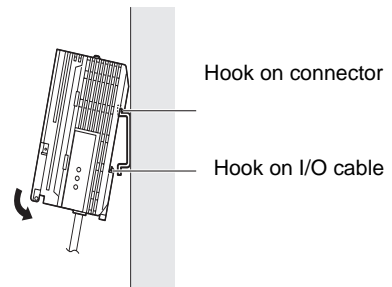

Always hook the connector end of the device on the DIN track first. Hooking the I/O cable end on the DIN track first may impair the mounting strength of the DIN track attachment.

CHECK!

3. Open the coupler cover on the Data Storage Unit and controller.
Slide the cover to remove.

4. Insert the Controller Link Unit into the connector on the Data Storage Unit.



CHECK!

The connectors are designed to be connected in a particular direction. Insert the connector in the direction so that the indented section of the Controller Link Unit in the figure on the right matches the connector protrusion on the Data Storage Unit.

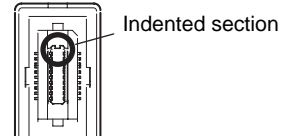
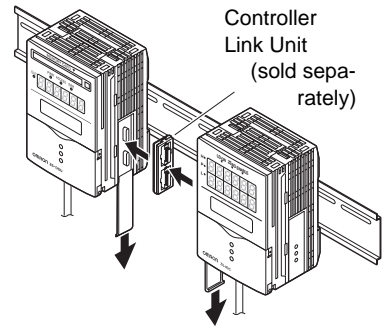

5. Slide the Controller, and insert into the connector on the Controller Link Unit.

● **Removal procedure**

The following describes how to remove the Data Storage Unit and controllers from the DIN track.

- 1. Slide the controller, and remove from the connector on the Controller Link Unit.**
- 2. Slide the Controller Link Unit and remove from the connector on the Data Storage Unit.**
- 3. Install the cover on the couplers of the Data Storage Unit and controller.**
- 4. Pull the hook on the I/O cable end downwards.**
- 5. Lift up the device from the I/O cable end, and remove it from the DIN track.**

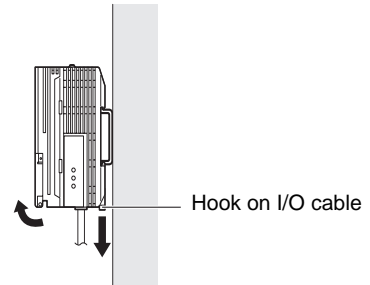
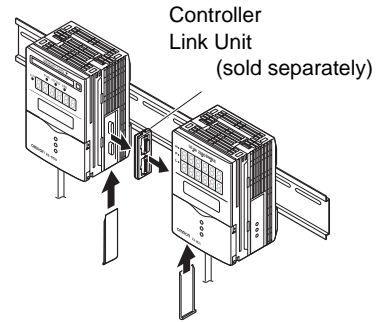

■ Mounting on a panel

The optional Panel Mount Adapters (ZS-XPM1/XPM2) can be used to mount the Data Storage Unit on a panel.

 Panel Mount Adapters p.6-7

1. Install the Data Storage Unit and controller on the DIN track.

 p.2-4



When mounting on a panel, be sure to install the DIN track on the rear side of the Data Storage Unit for support.

2. Push out the Data Storage Unit and controller from the rear of the panel towards the front.

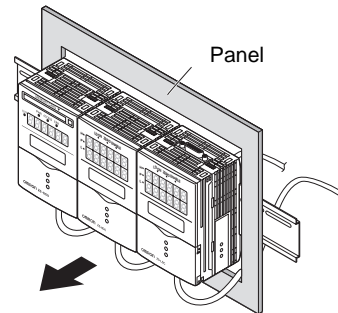

3. Install the small Mount Adapters on the four holes on the Data Storage Unit and controller.



Install the small Mount Adapters on all gang-mounted Data Storage Units and controllers.

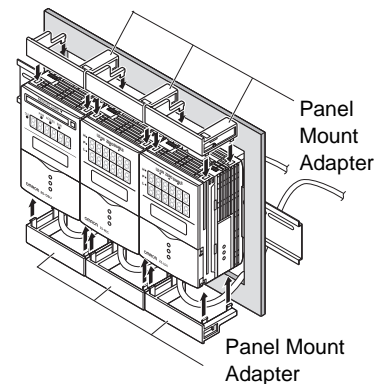

4. Install the long Mount Adapters on the two holes on the small Mount Adapter.



CHECK!

Install the long Mount Adapters only on both sides of gang-mounted Data Storage Units and controllers.

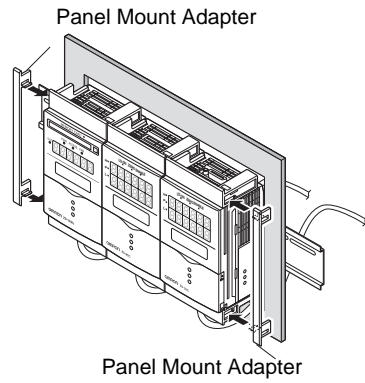

5. Install the Data Storage Unit and controllers with Panel Mount Adapters attached onto the panel from the front.



CHECK!

Take care not to pinch the I/O cable.

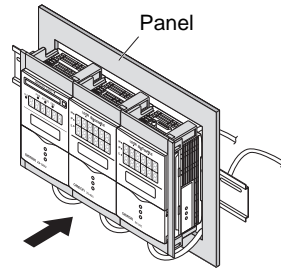

6. Hook the hooks of the mounting fixture onto the two holes of the small Mount Adapters and tighten the screws.



CHECK!

Attach two mounting fixtures each on all gang-mounted Data Storage Unit and controllers.

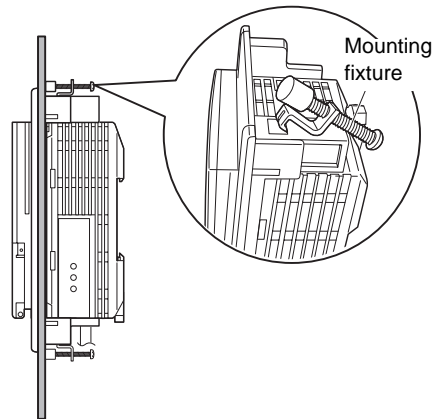

7. Make sure that the Data Storage Unit and controllers are firmly fixed on the panel.

Gang-mounted with Logging Target Controller

Up to 15 controllers can be gang-mounted (ZS-DSU: max. 1, ZS-MDC: max. 1, ZS-LDC: max. 9, ZFV: max. 5). Gang-mount in order from left, ZS-DSU, ZS-MDC, ZS-LDC, ZFV. For details on controllers, refer to the User's Manual for the respective controller.



- Provide power to all connected controllers.
- Only 1 Data Storage Unit and Multi-Controller can be connected in each gang-mounted group.

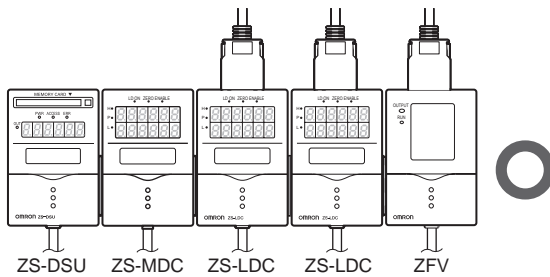
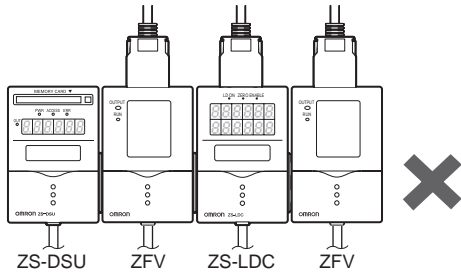
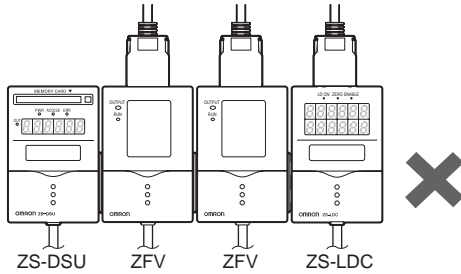
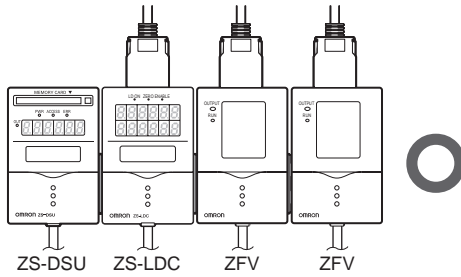

■ About channel No. when controllers are gang-mounted

When collecting data from gang-mounted controllers on the Data Storage Unit, select the target controller by its channel No. from left, CH0, CH1, CH2.

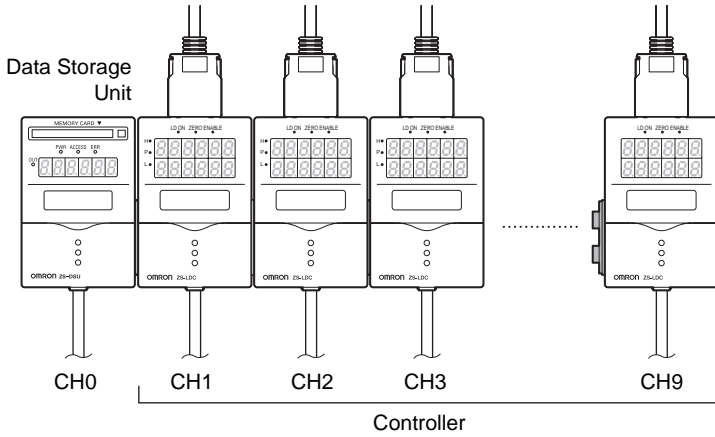

About the I/O cable

■ Wiring the I/O cable

The following shows the leads that comprise the I/O cable.

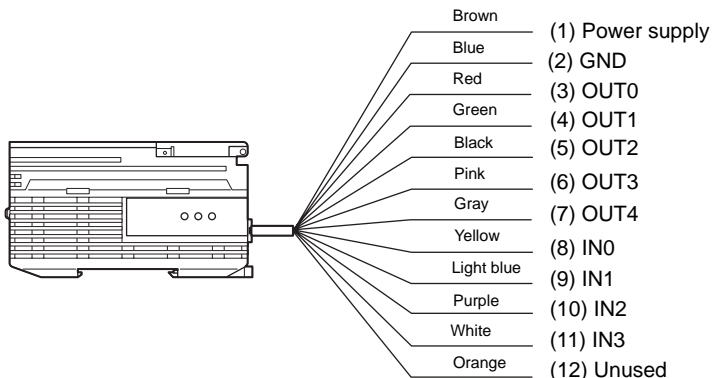

(1) Power supply

This connects the 24 VDC ($\pm 10\%$) power supply. When using a ZS-DSU with a PNP output, the power supply terminal is also the common I/O terminal for all I/O except for the linear output. Supply power from a DC power supply unit that has a countermeasure (safety ultra-low voltage circuit) built-in for preventing high voltages from occurring.



Recommended power supply unit p.1-9

Wire the power supply separately from other devices. Wiring them together or placing them in the same duct may cause induction, resulting in malfunction or damage.

(2) GND

The GND terminal is the 0V power supply terminal. When using a ZS-DSU with an NPN output, the GND terminal is also the common I/O terminal for all I/O except for the linear output.

(3) OUT0 (HIGH output)

This outputs judgment results (HIGH).

(4) OUT1 (PASS output)

This outputs judgment results (PASS).

(5) OUT2 (LOW output)

This outputs judgment results (LOW).

(6) OUT3 (ERR output)

This output turns ON when there is a Memory Card read/write error.

(7) OUT4 (BUSY output)

This output turns ON during data logging or saving of data to the Memory Card. The next start trigger is ignored even if it is generated while the BUSY output is ON.

(8) IN0 (external trigger (timing) input)

This input is for externally controlling the logging trigger.

(9) IN1 (line feed/row feed input)

This input is for performing a line feed/row feed on the logging data at any desired position.

(10) IN2 (sampling start)

This input is for starting sampling from a sampling stopped state.

(11) IN3 (sampling forced end)

This input is for forcibly stopping sampling (logging) from a sampling state or logging state.

■ I/O Circuit Diagrams
● NPNtype (ZS-DSU11)

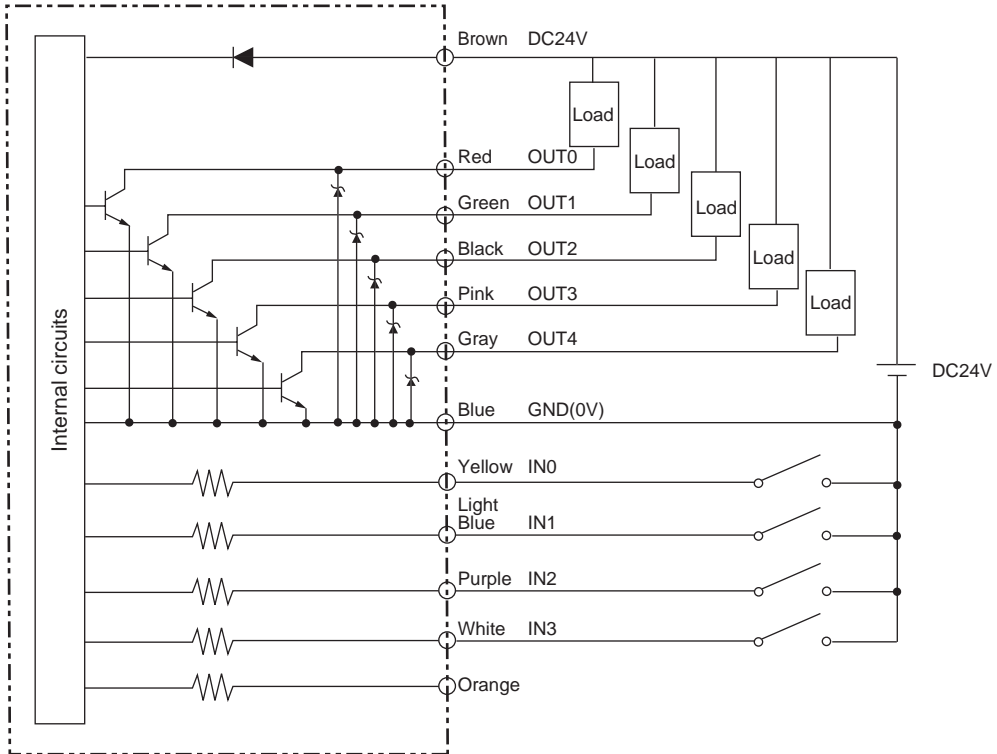

● PNPtype (ZS-DSU41)

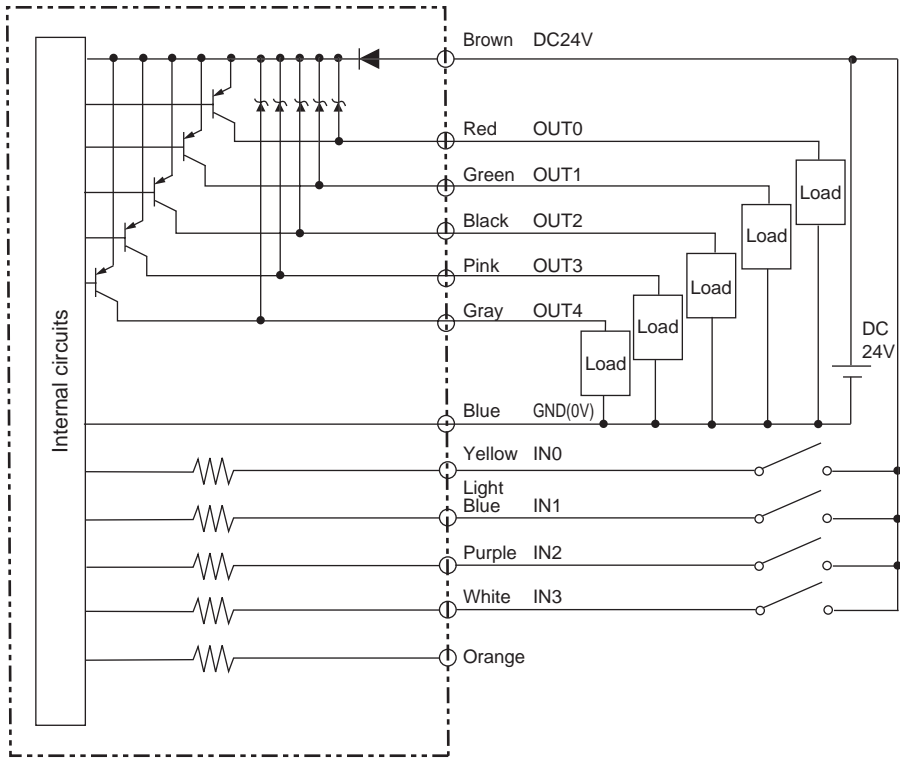

How to Insert and Remove the Memory Card

■ Inserting the Memory Card

1. Press the EJECT button on the Memory Card slot, and remove the protective dummy card.

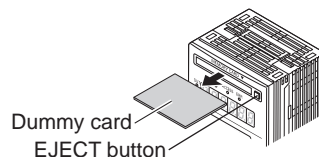

2. Insert the Memory Card.

Insert the Memory Card with its label surface facing up.

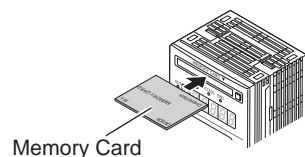

■ Removing the Memory Card



CHECK!

Before removing the Memory Card, make sure that both the CF power LED and CF access LED are out. Removing the Memory Card with these LEDs lit might cause data recorded on the Memory Card to be lost, or damage the Memory Card or the Data Storage Unit.

1. Select FUN Mode-[SYSTEM]-[EJECT].

Make sure that the CF power LED is out.

2. Press the EJECT button on the Memory Card slot, and remove the Memory Card.

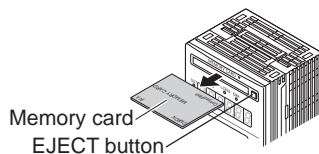

3. When the Memory Card is not to be inserted for a long time, insert the protective dummy card.

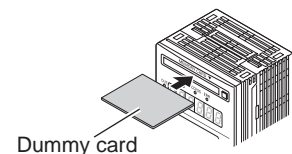

MEMO

Section 3

SETUP

☒ Setting Flow	3-2
☒ About Setup	3-4
Basic Knowledge for Operation	3-4
List of Setting Items	3-11
☒ Setting the Logging Conditions	3-15
Source settings	3-15
Setting the start trigger	3-16
Setting the end trigger	3-21
Sampling Settings	3-26
Setting the Data Format	3-31
☒ Setting Banks	3-33
Switching banks	3-33
Clearing banks	3-33
☒ External Bank Function	3-34
☒ Setting the System Environment	3-35
Ejecting the Memory Card	3-35
Saving setup data	3-35
Initializing setup data	3-36
Checking system information	3-36
Setting the System Clock	3-36
Initializing the Memory Card	3-37
Setting the save start No.	3-37
Setting key lock	3-37
Setting the display language	3-38
☒ Setting the Display Method	3-39
Setting the display	3-39
Setting the LCD display	3-40
HELP	3-41

Setting Flow

Preparation for Measurement

Installation and Connection

Gang-mount the Data Storage Unit and Controller.



Section 2
Installation and Connection p.2-2

Power ON

Setting of Logging Conditions

Setting the source

■ Data logging source
Assign the controller or data to be logged as the source.



p.3-15

■ Image logging source
Set whether to log image.



p.3-16

Setting the start trigger

Set the logging start condition.



p.3-16

Setting the end trigger

Set the logging end condition.



p.3-21

Setting sensing

Set the sampling interval, stop condition, method for saving to Memory Card, etc.



p.3-26

Setting the data format

Set the format that logging data is to be saved in.



p.3-31

Save Setup

Save Setup Data

Save the data you have set.



Saving setup data p.3-35



CHECK!

After you have set the data, be sure to save the setup data. All settings will be deleted if you turn the power OFF without saving the data.

When a Problem Occurs...



The Data Storage Unit does not operate correctly.

Troubleshooting p.6-2



An error message has appeared

When [Error] is displayed on the Main Display p.6-3



Want to know the meaning of terms

Glossary p.6-4

Applied Use of Functions

Setting banks

Set up the banks.

p.3-33

External bank function

Transfer bank data from the controller to the Memory Card or from the Memory Card to the controller.

p.3-34

Setup up the system environment

Set up the system environment.

- Removing the Memory Card p.2-15
- Initializing the setup data p.3-36
- Checking the system information p.3-36
- Setting the system clock p.3-36
- Initializing the Memory Card p.3-37
- Setting the save start No. p.3-37
- Setting key operations p.3-37
- Setting the display language p.3-38

External I/O

Set the alarm outputs and the thresholds for alarm judgement.

p.4-1

Additional Functions

Setting the display method

Set what is to be displayed on the Data Storage Unit during measurement in the RUN mode.

p.3-39

About Setup

Basic Knowledge for Operation

The following describes basic operation of the Data Storage Unit before you set it up.

■ Switching Modes

The ZS-DSU has the following 3 operating modes. Switch to the desired mode before you start operation. Basically, the RUN mode is switched to and logging starts after logging conditions are set in the FUN mode.

To switch the operating mode, use the Mode Switch.

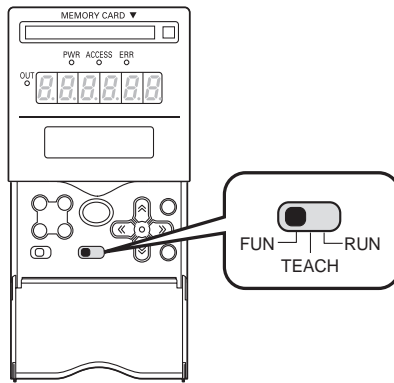

Mode	Description
FUN Mode	Mode for setting the logging conditions
TEACH Mode	This mode is for setting the threshold values for alarm output.
RUN mode	This mode is for executing logging. This mode is for setting the details of the main display and other display-related items, and when using the external bank function.



When you switch the operating mode after changing the measurement conditions, you will be prompted to save the settings. Save the settings as required. If you turn off the Digital Storage Unit without saving these settings, the newly set measurement conditions will be cleared from memory. You can also save all the settings later on.



Saving setup data p.3-35

■ Displays and Key Operations

The Digital Storage unit has digital displays and an LCD screen. The details displayed on these differ according to the operating mode.

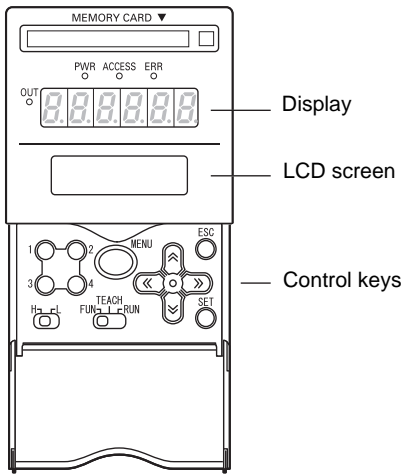

Alphabet characters that appear on the digital displays

A	B	C	D	E	F	G	H	I
R	b	c	d	E	F	G	h	i
J	K	L	M	N	O	P	Q	R
J	P	L	ñ	n	o	P	q	r
S	T	U	V	W	X	Y	Z	
S	t	U	u	Y	y	z		

● FUN Mode

The LCD screen displays the setup menus.

The No. at the top of each menu corresponds to a function key.

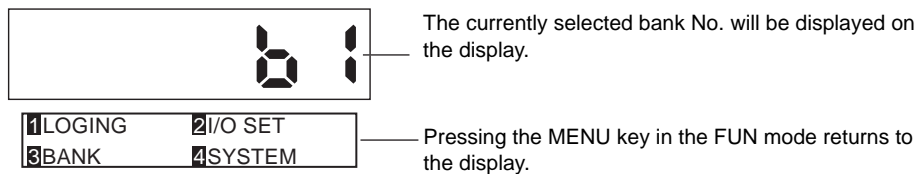

"← →" displayed at the top right of the LCD screen indicates that the setup menu is made p of two or more pages. Scroll pages by the LEFT or RIGHT key.

Top menu in FUN mode



Key Operations

Key		FUN Mode
Function keys		Directly sets the No. preceding the items displayed on the LCD screen.
← LEFT key → RIGHT key		The function changes depending on the settings. - Scrolls pages in list menus. - Selects the digit of numerical values.
↑ UP key ↓ DOWN key		Changes numerical values during numerical value input.

Key		FUN Mode
MENU key	MENU 	Displays the top menu of the FUN mode.
SET key	SET 	Applies the item you are setting up.
ESC key	ESC 	Returns to the previous menu.

The following describes basic operations, for example, when setting external input signal [OFF→ON] as the logging start trigger.

- 1. Press function key 1 representing [LOGING].**

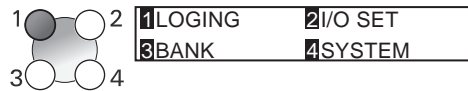

- 2. Press function key 2 representing [TRIGGER].**

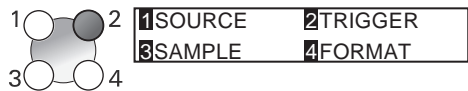

- 3. Press function key 1 representing [START].**

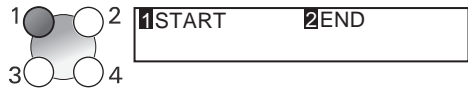

The currently selected No. is displayed flashing.



- 4. Press function key 2 representing [EXT].**

- 5. Press function key 1 representing [EDGE].**



- 6. [Press function key 1 representing [OFF→ON].**

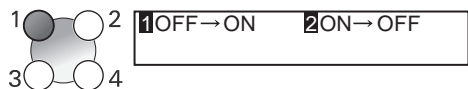

The "Complete!" message is displayed.

7. Press the MENU key to return to the top menu.

Pressing the ESC key returns to the previous menu.

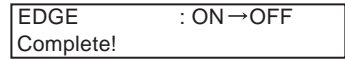

● RUN Mode

This mode displays information such as the remaining space on the Memory Card on the display. The meaning of items on the display is displayed on the upper section of the LCD. The current logging-related status is displayed on the lower section of the LCD.

Pressing the MENU key displays the display customize menu.

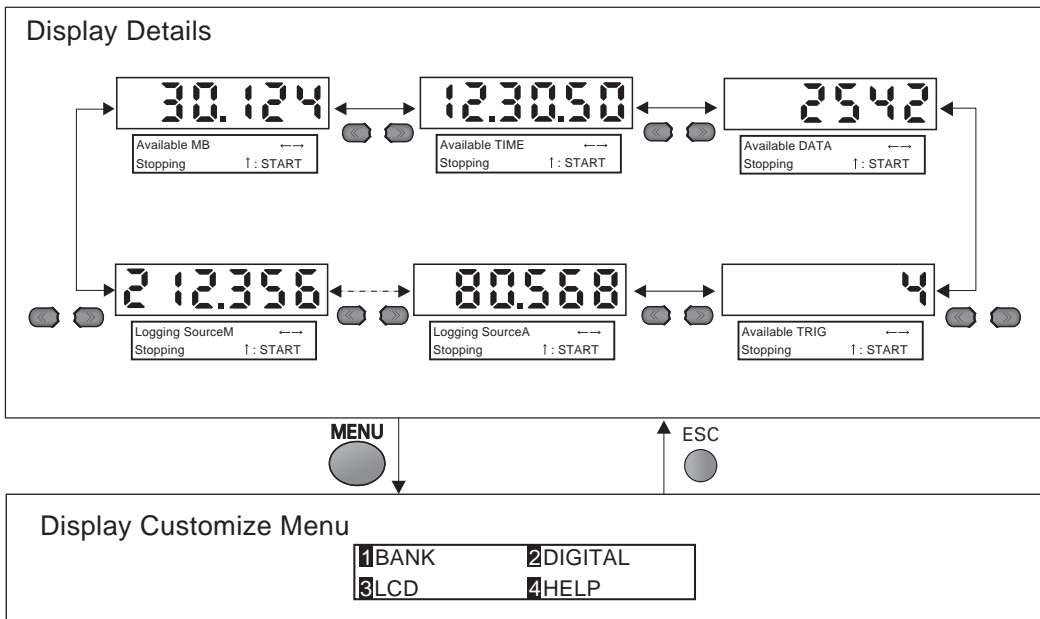







Details displayed on the upper section of the LCD screen

Display Details	Description
Available MB	Displays the amount of space remaining on the Memory Card.
Available TIME	Displays the remaining logging time when the end trigger is set to [TIME].
Available DATA	Displays the remaining number of logging points when the end trigger is set to [QUANT].  CHECK! When ONE SHOT is set, the remaining number of logging points is displayed according to the remaining amount of space in the internal buffer even when the end trigger is set to other than [QUANT].
Available TRIG	Displays the remaining number of logging repeats when the sampling mode is set to [REPEAT].
LOGGING Source A to N	Displays the measured value of the currently selected source.

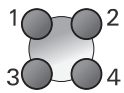
Details displayed on the lower section of the LCD screen

Display Details	Description
Stopping↑:START	This indicates a stopped state. The Data Storage Unit is standing by for the start trigger by the ↑UP key.
Waiting↓ :STOP	This indicates that sampling has started, and that the Data Storage Unit is standing by for the logging start trigger. To stop sampling, press the ↓DOWN key.
Waiting↑ :TRIG	This indicates that sampling has started, and that the Data Storage Unit is standing by for the logging start trigger. To start logging, press the ↑UP key.(only when SW is selected for TRIGGER)
Data Saving	This indicates that data is being saved.

Key Operations







Key	Measured Value Display	Display Customize Menu
Function keys 	Not used	Directly select functions.
← LEFT key → RIGHT key 	Switches the details that appear on the display.	The function changes depending on the settings. • Scrolls pages in list menus. • Selects digits.
↑ UP key ↓ DOWN key 	Press the ↑UP key to start sampling and set the Data Storage Unit to the start trigger standby state. To forcibly exit the start trigger standby state, press the ↓DOWN key. Note, however, that a file save confirmation message will be displayed.	The function changes depending on the settings. • Changes numerical values. • Changes text.
MENU key 	Displays the display customize menu.	Returns to the top of the display customize menu.
SET key 	Not used	Applies numerical value settings.
ESC key 	Not used	Returns to the previous menu. When the top menu is displayed, returns to the measured value display.

● **TEACH Mode**

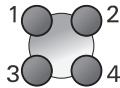
Displays the measured value of the source to be output to the ZS-DSU on the display. Which of the HIGH or LOW threshold values is displayed changes according to the setting of the threshold selector switch.



Key Operations

Key		DIRECT IN
Function keys		Not used
← LEFT key → RIGHT key		Selects the digit in the threshold numerical value.
↑ UP key ↓ DOWN key		Changes the threshold numerical value.
MENU key		Not used
SET key		Applies the newly set threshold value.
ESC key		Cancels the newly set threshold value.

List of Setting Items

■ FUN Mode

This is the mode for setting the measurement conditions.

FUN Mode		Settings	Default Value	Option/Range	Pages		
	LOGING						
	SOURCE	SOURCE A to N	SELECT	-	-	p.3-15	
			CH (ZS-LDC and ZFV)	-	1CH to (max. gang-mounted channel No.)		
			DATA (ZS-MDC only)	-	TASK1 to 4, Input A to I		
			SAVE	OFF	OFF, ON		
			LABEL	LABEL	-		
		TRIGGER	START (default value: BUTTON)	BUTTON	-	-	p.3-16
			EXT	-	-	-	p.3-17
			EDGE	OFF→ON	OFF→ON, ON→OFF		
			DELAY	0 ms	-9999 to 9999 ms ⁽¹⁾		
				0 Page	-127 to 127 Page ⁽²⁾		
			DATA				p.3-18
			SOURCE	-	Source A to N		
			EDGE	UP	UP, DOWN		
			DELAY	0 ms	-9999 to 9999 ms ⁽¹⁾		
				0 Page	-127 to 127 Page ⁽²⁾		
			WINDOW	-	-	-	p.3-19
			SOURCE	-	Source A to N		
			UPPER	-	-999.999 to 999.999		
			LOWER	-	-999.999 to 999.999		
			MODE	IN	IN, OUT		
		DELAY	0 ms	-9999 to 9999 ms ⁽¹⁾			
			0 Page	-127 to 127 Page ⁽²⁾			
		I/O	-	-	-	p.3-20	
		SOURCE	-	Source A to N			
		I/O SEL	-	IN0 to 3, OUT0 to 4			
		ACTIVE	OFF→ON	OFF→ON, ON→OFF			
		DELAY	0 ms	-9999 to 9999 ms ⁽¹⁾			
			0 Page	-127 to 127 Page ⁽²⁾			
		hour	00h00m00s	-	-	p.3-21	

Settings	Default Value	Option/Range	Pages
END (default value: BUTTON)	BUTTON	-	p.3-21
EXT	-	-	p.3-22
EDGE	OFF→ON	OFF→ON, ON→OFF	
DATA	-	-	p.3-22
SOURCE	-	SourceA to N	
EDGE	UP	UP, DOWN	
WINDOW	-	-	p.3-23
SOURCE	-	SourceA to N	
UPPER	-	-999.999 to 999.999	
LOWER	-	-999.999 to 999.999	
MODE	IN	IN, OUT	
I/O	-	-	p.3-24
SOURCE	-	SourceA to N	
I/O SEL	-	IN0 to 3, OUT0 to 4	
ACTIVE	OFF→ON	OFF→ON, ON→OFF	
HOUR	00h00m00s	-	p.3-24
QUANT	-	1 to 999999 Point ^(*)	p.3-25
		1 to 128 Page ^(**)	
TIME ^(**)	00h00m00s	-	p.3-25
MODE	1SHOT (NORMAL)	(When image log is set to ON) 1SHOT (CURRENT, NORMAL)	p.3-26
	REPEAT	(When image log is set to OFF) 1SHOT, REPEAT	
STOP	COUNT: 1	COUNT, NONE, TIME	
FILE	NEW	(When image log is set to ON) NEW	
		(When image log is set to OFF) NEW, ADD, OVER WR	
CYCLE	-	(when 1SHOT is set) 150μs to 1 hr	
		(when REPEAT is set) 10 ms to 1 hr	
		(When image log is set to ON) ALL, NG	
I/ODATA	NONE	NONE, SAVE	p.3-31
ALIGN	COLUMN	ROW, COLUMN	
LF	OFF	OFF, ON	
SELECT CH	-	1CH to (max. gang-mounted channel No.)	p.3-16
IMAGE SAVE	ON	OFF, ON	
SOURCE	-	SourceA to N	p.4-2
HYS	20μm	0 to 999.999	

		Settings	Default Value	Option/Range	Pages	
BANK	CHANGE		BANK1	BANK1, BANK2, BANK3, BANK4	p.3-33	
	CLEAR		-	(Initializes the bank settings.)		
SYSTEM	EJECT		-	(Ejects the Memory Card.)	p.3-35	
	SAVE		-	(Saves the Data Storage Unit settings.)	p.3-35	
	INIT		-	(Initializes the Data Storage Unit settings.)	p.3-36	
	INFO	CF SIZE		-	(Displays the RAM size.)	p.3-36
		CYCLE		-	(shortest measurement cycle)	
		VERSION		-	(Displays the Data Storage Unit version.)	
	CLOCK	DATE		-	(Data Storage Unit system clock)	p.3-36
		HOUR		-		
	COM	RS-232C	LENGTH	8BIT	8BIT, 7BIT	p.4-5
			PARITY	NONE	NONE, ODD, EVEN	
STOP			1BIT	1BIT, 2BIT		
BAUDRAT			38400	9600A19200A38400A57600 A115200		
DELIMIT			CR	CR, LF, CR+LF		
MODE			COMPWAY	COMPWAY, NORMAL	p.4-5	
NODE		0	0 to 16	p.4-5		
CF	FORMAT		-	-	p.3-37	
	FILE No.		(current start No.)	0 to 999	p.3-37	
	KEYLOCK		OFF	OFF, ON	p.3-37	
	LANGUAG		Japanese	Japanese, English	p.3-38	

*1: When [IMAGE] - [SOURCE] - [IMGSAVE] is ON

*2: When [IMAGE] - [SOURCE] - [IMGSAVE] is OFF

■ RUN Mode

In the RUN mode, you can customize the details that are displayed in the digital displays.

To call the display customize menu, press the MENU key in the RUN mode.

RUN mode		Settings	Default Value	Option/Range	Pages
BANK	CF→CONT	CF→CONT: FILE SEL	-	BANK0 to BANK127	p.3-34
		CF→CONT: CH SEL	-	1CH to 10CH	
	CONT→CF	CTR→CF: CH SEL	-	1CH to 10CH	p.3-34
		CTR→CF: BANK SEL	-	B1 to B4	
		CTR→CF: FILE SEL	-	BANK0 to BANK127	
	DIGITAL	DOT	3rd	0 to 5th	p.3-39
ECO		NORMAL	NORMAL, ECO, OFF	p.3-39	
LCD	ON/OFF	ON	ON, AUTOOFF, OFF	p.3-40	
	B.LIGHT	ON	ON, AUTOOFF, OFF	p.3-40	
	CUSTOM	OFF	ON/OFF, CUSTOM	p.3-40	
HELP			-	-	p.3-41

■ TEACH Mode

This is the mode for setting the threshold values

TEACH Mode	Settings	Default Value	Option/Range	Pages
	DIRECT IN	-	-	p.4-3

Setting the Logging Conditions

Source settings

Assign the controller or data to be logged as the source.

■ Data logging source



▶ FUN Mode-[LOGING]-[SOURCE]-[SourceA to N]

Setting	Description
SELECT	<p>Assigns a CH No. or data as the selected source.</p> <p> CHECK! When the Data Storage Unit is connected to the ZS-LDC or ZFV, only the CH selection is displayed. When the Data Storage Unit is connected to the ZS-MDC, only the data selection is displayed.</p>
CH	<p>Assigns the CH No. of the ZS-LDC or ZFV to be logged. Range: None, 1CH onwards (largest gang-mounted CH)</p>
DATA	<p>Assigns the data of the ZS-MDC to be logged. Range: TASK1 to TASK4, Input A to Input I</p>
SAVE	<p>Set this item to ON to save logged data. Set this item to OFF in the case of sources that are used solely as logging triggers. Range: OFF, ON (default value: OFF)</p>
LABEL	<p>Sets the label for the logging data.</p> <ul style="list-style-type: none"> • Call up the initial character of each character group using function keys 1 to 4. (Other signals are assigned to the latter half of each group.) <ul style="list-style-type: none"> 1: A to Z 2: a to z 3: KANA 4. Numbers, :, ;, <, =, >, ?, @ • Switch the characters in order using the UP or DOWN key. • Move the digits by the LEFT or RIGHT key. • To clear a character, select a space.

■ Image logging source

Set when saving images with measurement data.

▶ FUN Mode-[IMAGE]-[SOURCE]

Setting	Description
SELECT CH	<p>Assigning channel numbers for ZFV where image data will be logged. Only one channel can be assigned. Range: 1CH to (max. gang-mounted channel No.)</p> <p> Assign CH numbers of amplifier units with sensor heads connected. CHECK!</p>
IMAGE SAVE	<p>When logging image data, set to ON. Range: ON, OFF (default value: ON)</p> <p> When a Multi-Controller is connected, ON cannot be selected. CHECK!</p>



- When [ALL CLEAR] is executed with ZFV, reset ZS-DSU conditions.
- Do not change ZFV [IMAGE RATE] within image logging.

Setting the start trigger

Set the conditions for starting logging.



Select one of “SW, EXT, DATA, WINDOW, I/O, HOUR” as the start trigger. When [LOGGING]-[TRIGGER]-[START] is selected, the first No. that is blinking indicates the current start trigger. The default value is [SW].

■ BUTTON

This setting item is for inputting the start trigger by key operation on the ZS-DSU. Logging starts when the ↑UP key is pressed.

▶ FUN Mode-[LOGGING]-[TRIGGER]-[START]-[BUTTON]

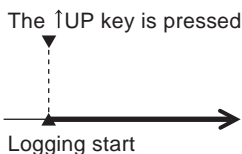

■ EXT INPUT SLOPE

This item is for setting the external input signal as the logging start trigger.

▶ FUN Mode-[LOGING]-[TRIGGER]-[START]-[EXT]

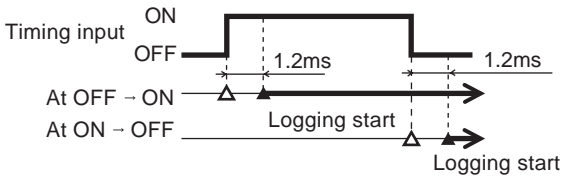
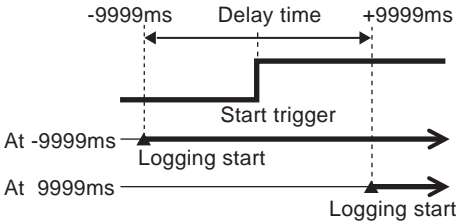
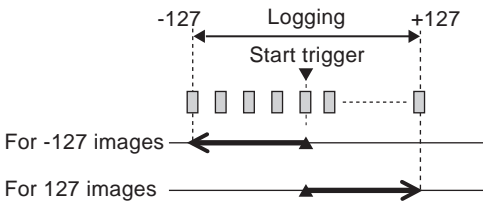
Setting	Description
EDGE	<p>Select at which timing, ON or OFF, of the timing signal that logging is to be started. Range: OFF→ON, ON→OFF (default value: OFF→ON)</p> <p> CHECK! Delays start of logging by about 1.2 ms at most from input of the external trigger.</p> 
DELY	<p>Set the delay time when you want to start logging a little before or a little after the start trigger. Range: -9999 to 9999 (ms) (default value: 0 ms)</p>  <p>When set to image logging ON, set the delay time using the no. of images. Range: - 127 to 127 Page (No. of images) (default value: 0 images)</p> 

DATA SLOPE

This item is for setting the change in the state of the data (measured value) as the logging start trigger. Set the trigger level. When the data falls above or below this preset trigger level value, this is taken to be the start trigger.

► FUN Mode-[LOGING]-[TRIGGER]-[START]-[DATA]

Setting	Description
SOURCE	Select the source to be used as the logging start trigger. Range: SourceA to N
EDGE	Select whether above or below the trigger level is to be used as the start trigger. Then, also set the trigger level. Range: UP, DOWN (default: UP)
DELAY	Set the delay time when you want to start logging a little before or a little after the start trigger. Range: -9999 to 9999 (ms) (default value: 0 ms)

At up edge

At down edge

At -9999ms

At 9999ms

For -127 images

For 127 images

When set to image logging ON, set the delay time using the no. of images.
Range: - 127 to 127 Page (No. of images) (default value: 0 images)

■ DATA WINDOW

This item is for setting the change in the state of the data (measured value) as the logging start trigger. Set the upper/lower limit value. When the measured value falls inside or outside of that range, this is taken to be the start trigger.

► FUN Mode-[LOGING]-[TRIGGER]-[START]-[WINDOW]

Setting	Description
SOURCE	Select the source to be used as the logging start trigger. Range: SourceA to N
UPPER	Sets the upper limit value of the specified range. Range: -999.999 to 999.999
LOWER	Sets the lower limit value of the specified range. Range: -999.999 to 999.999
MODE	Select either of the measured value inside or outside the specified range is to be used as the start trigger. Range: IN, OUT (default: IN) <div style="text-align: center;"> </div>
DELAY	Set the delay time when you want to start logging a little before or a little after the start trigger. Range: -9999 to 9999 (ms) (default value: 0 ms) <div style="text-align: center;"> </div> <p>When set to image logging ON, set the delay time using the no. of images. Range: - 127 to 127 Page (No. of images) (default value: 0 images)</p> <div style="text-align: center;"> </div>

I/O RESULT

Set this item when you want to apply a trigger by the input result (e.g. trigger input) from a controller on a specific CH assigned as the source or by the output result (HIGH/PASS/LOW/, etc.).

► FUN Mode-[LOGING]-[TRIGGER]-[START]-[I/O]

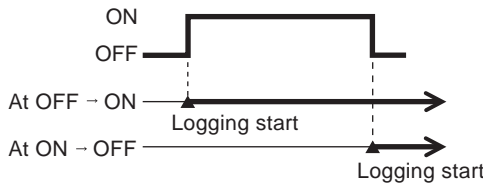
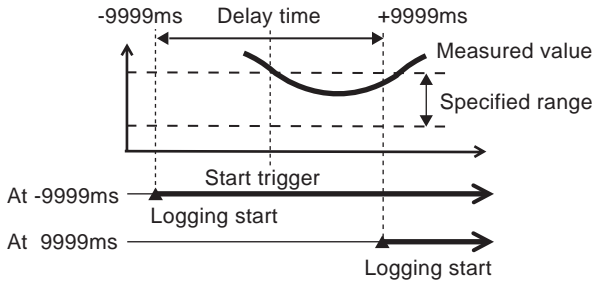
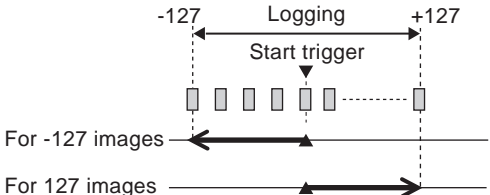
Setting	Description
SOURCE	Select the source to be used as the logging start trigger. Range: SourceA to N
I/O SEL	Select which I/O signal on the channel assigned as the selected source is to be used as the start trigger. Range: IN0 to IN3, OUT0 to OUT4
ACTIVE	Sets the change in state of the signal, from ON to OFF or from OFF to ON, to be taken as the trigger. Range: OFF→ON, ON→OFF (default value: OFF→ON) 
DELAY	Set the delay time when you want to start logging a little before or a little after the start trigger. Range: -9999 to 9999 (ms) (default value: 0 ms)  <p>When set to image logging ON, set the delay time using the no. of images. Range: - 127 to 127 Page (No. of images) (default value: 0 images)</p> 

■ HOUR

This item is for setting the time (hours, minutes, seconds) that logging is to be started. The system clock must be set on the ZS-DSU beforehand.

 Setting the System Clock p.3-36

▶ FUN Mode-[LOGING]-[TRIGGER]-[END]-[HOUR]

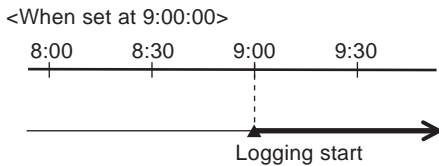

Setting the end trigger

Set the conditions for ending logging.



- Select one of “BUTTON, EXT, DATA, WINDOW, I/O, HOUR, TIME, QUANT” as the end trigger. When [LOGING]-[TRIGGER]-[END] is selected, the first No. that is blinking indicates the current end trigger. The default value is [BUTTON].
- Time cannot be selected at image logging ON.

■ BUTTON

This setting item is for inputting the end trigger by key operation on the ZS-DSU. Logging ends when the UP key is pressed.

▶ FUN Mode-[LOGING]-[TRIGGER]-[END]-[BUTTON]

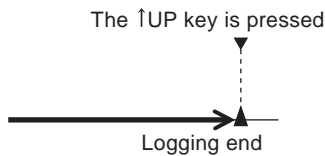

EXT INPUT SLOPE

This item is for setting the external input signal as the logging end trigger.

► FUN Mode-[LOGING]-[TRIGGER]-[END]-[EXT]

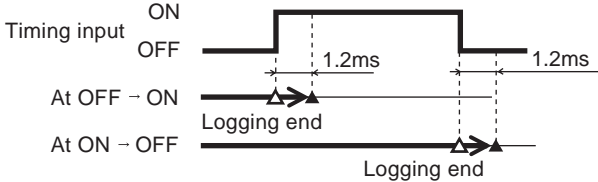
Setting	Description
EDGE	<p>Select at which timing, ON or OFF, of the timing signal that logging is to end. Range: OFF→ON, ON→OFF (default value: OFF→ON)</p> <p> CHECK! Delays end of logging by about 1.2 ms at most from input of the external trigger.</p> 

DATA SLOPE

This item is for setting the change in the state of the data (measured value) as the logging end trigger. Set the trigger level. When the data falls above or below this preset trigger level value, this is taken to be the end trigger.

► FUN Mode-[LOGING]-[TRIGGER]-[END]-[DATA]

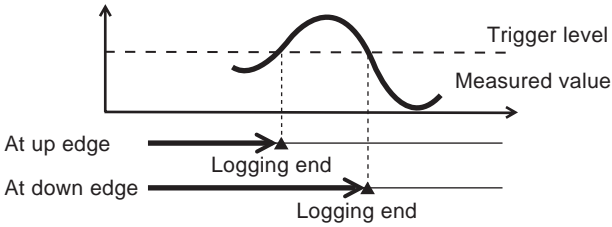
Setting	Description
SOURCE	<p>Select the source to be used as the logging end trigger. Range: SourceA to N</p>
EDGE	<p>Select whether above or below the trigger level is to be used as the end trigger. Then, also set the trigger level. Range: UP, DOWN (default: UP)</p> 

■ DATA WINDOW

This item is for setting the change in the state of the data (measured value) as the logging end trigger. Set the upper/lower limit value. When the measured value falls inside or outside of that range, this is taken to be the end trigger.

▶ FUN Mode-[LOGING]-[TRIGGER]-[END]-[WINDOW]

Setting	Description
SOURCE	Select the source to be used as the logging end trigger. Range: SourceA to N
UPPER	Sets the upper limit value of the specified range. Range: -999.999 to 999.999
LOWER	Sets the lower limit value of the specified range. Range: -999.999 to 999.999
MODE	Select either of the measured value inside or outside the specified range is to be used as the end trigger. Range: IN, OUT (default: IN) <div style="text-align: center;"> </div>

■ I/O RESULT

Set this item when you want to apply a trigger by the input result (e.g. trigger input) from a controller on a specific CH assigned as the source or by the output result (HIGH/PASS/LOW etc.).

▶ FUN Mode-[LOGING]-[TRIGGER]-[END]-[I/O]

Setting	Description
SOURCE	Select the source to be used as the logging end trigger. Range: SourceA to N
I/O SEL	Select which I/O signal on the channel assigned as the selected source is to be used as the start trigger. Range: IN0 to IN3, OUT0 to OUT4
ACTIVE	Sets the change in state of the signal, from ON to OFF or from OFF to ON, to be taken as the trigger. Range: OFF→ON, ON→OFF (default value: OFF→ON)

■ HOUR

This item is for setting the time (hours, minutes, seconds) that logging is to end. Data logging ends when the preset time is reached.

The system clock must be set on the ZS-DSU beforehand.



Setting the System Clock p.3-36

▶ FUN Mode-[LOGING]-[TRIGGER]-[END]-[HOUR]

<When set at 17:00:00>

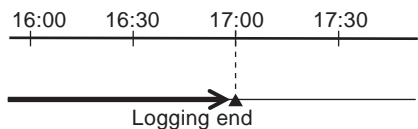

■ DATA QUANT

Set the number of data points to acquire. Data logging ends when the preset number of data points has been got since start of logging. One cycle set at [SAMPLING]-[INTERVAL] is one data item.

When logging measured value data, 1 cycle set at [SAMPLING] - [INTERVAL] becomes 1 data.

Range: 1 to 999999 (Points)

When set to image logging ON, set the no. of images.

Range: 1 to 128 (Pages)

▶ FUN Mode-[LOGING]-[TRIGGER]-[END]-[QUANT]

<When data points are set at 7>

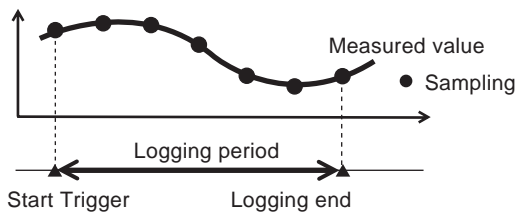

■ Time

Set the time (hours, minutes, seconds) from the start trigger up to the end trigger. Data logging ends when the preset time is reached since the start trigger.

The system clock must be set on the ZS-DSU beforehand.

 Setting the System Clock p.3-36

▶ FUN Mode-[LOGING]-[TRIGGER]-[END]-[TIME]

<When set at 1 hour>

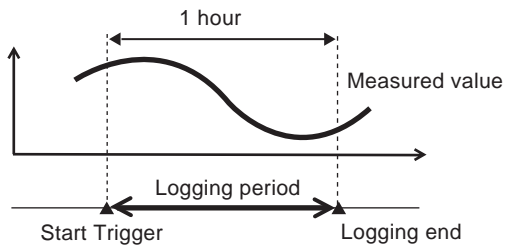

 Cannot be selected at image logging ON.
CHECK!

Sampling Settings

Set the sampling interval, stop conditions, save format to Memory Card, etc.

■ At image logging ON

► FUN Mode - [LOGING]-[SAMPLE]

Setting	Description
MODE	Sets the save method to the Memory Card.
1SHOT	<p>Store data in ZS-DSU RAM then save together to memory card.</p> <p> CHECK! <ul style="list-style-type: none"> The next start trigger is not accepted until saving of the file to Memory Card is completed. When the save is completed, BUSY output turns ON. Data can be sampled at high speed during logging as data is buffered to internal RAM on the ZS-DSU without the Memory Card being accessed. The size of data that can be saved continuously without any omissions is affected by the size of the internal RAM on the ZS-DSU. </p>
CURRENT	<p>After end trigger, save data for the latest 128 images.</p> <p>Image data is buffered to internal RAM from start trigger to end trigger. When buffering more than 128 images, data for the latest 128 images will be continuously buffered.</p>
NORMAL	<p>After start trigger, save data for a max. 128 images.</p> <p>If image data for 128 images is saved after start trigger input, file save to memory card.</p>



Setting	Description
STOP (stop conditions)	Sets the sampling stop (start trigger standby state) conditions.
COUNT	Sets how many times the start trigger to end trigger sequence is to be executed. Sampling stops when the preset start trigger to end trigger sequence count is repeated.(default value: 1)
NONE	In this state, sampling (start trigger standby state) is performed at all times. Samples is not stopped.
TIME	Stops sampling when the specified time elapses.
FILE	Set how the file (logging data) is to be written to Memory Card.
NEW	A new file is created at each start trigger.(default value)
CYCLE	Set image data logging conditions.  The sampling interval depends on the trigger cycle for the controller outputting images. CHECK!
ALL	Log all measurement images of amplifier unit.
NG	Log measurement images at NG.
MODE	Set judgment description for data assigned to Sources A through N. For sources where ZS-LDC and ZS-MDC are targets, OK at PASS output, and NG at HIGH or LOW output. Range: OR, AND <ul style="list-style-type: none"> • OR: When 1 judgment target source is NG, results are saved to the memory card. • AND: When all judgment target sources are NG, results are saved to the memory card.
SOURCE A to N	Set source used for judgment. Range: OFF, ON



- Logging timing is when the image data is inputted from ZFV, thus ZS-DSU cycle display ([System] - [Data] - [Cycle]) becomes “- - - - -” (undefined).
- A max. 128 images can be logged.(Does not depend on ZS-DSU sampling interval)

■ **At image logging OFF**

▶ FUN Mode-[LOGING]-[SAMPLE]

Setting	Description
MODE	Sets the save method to the Memory Card.
1SHOT	Sampling data is first stored in RAM on the ZS-DSU at short sampling intervals, and is then batch-saved to Memory Card. Data can be logged at a faster speed at a sampling interval shorter than the REPEAT setting. 1SHOT comes in handy when testing whether or not measurement has been performed correctly.  Sampling Timing Chart p.3-29
REPEAT	Sampling data is stored to RAM and saved to Memory Card simultaneously. This type of logging is not affected by internal RAM size, and is suited to data logging over an extended period. (default value)  Sampling Timing Chart p.3-30
STOP (stop conditions)	Sets the sampling stop (start trigger standby state) conditions.
COUNT	Sets how many times the start trigger to end trigger sequence is to be executed. Sampling stops when the preset start trigger to end trigger sequence count is repeated. (default value: 1)
NONE	In this state, sampling (start trigger standby state) is performed at all times. Samples is not stopped.
TIME	Stops sampling when the specified time elapses.
FILE	Set how the file (logging data) is to be written to Memory Card.
NEW	A new file is created at each start trigger. (default value)
OVER WR	A new file is created at the 1st start trigger after the state changes from a stopped state to start of sampling, and the same file is overwritten with the data at the 2nd start trigger. The same file is overwritten with data until the state changes to a stopped state. When the file is overwritten, the original logging data is erased.
ADD	A new file is created at the 1st start trigger after the state changes from a stopped state to start of sampling, and the data is added to the same file from the 2nd start to end trigger sequence onwards. Data is added to the same file until the state changes to a stopped state.
CYCLE	Sets the sampling interval in data logging. RANGE: When 1SHOT is selected, 150μs to 1 hour When REPEAT is selected, 10 ms to 1 hour

■ Timing Charts

● ONE SHOT mode (high-speed logging)

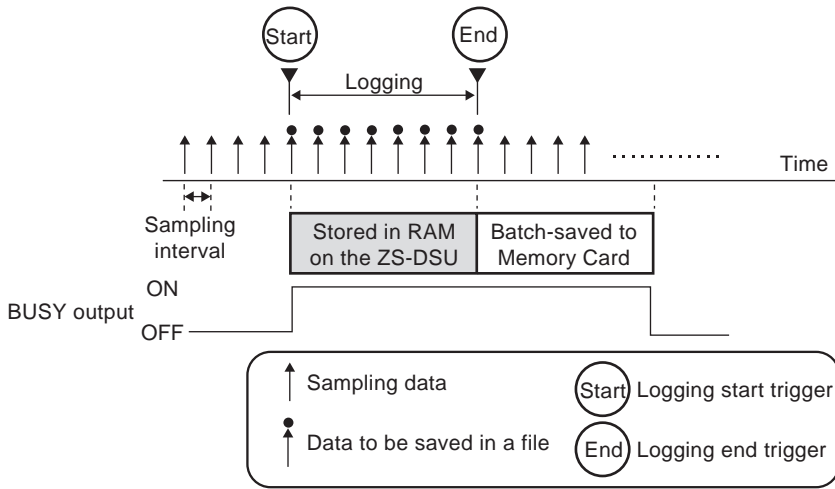

CHECK!

- The next start trigger is not accepted until saving of the file to Memory Card is completed. When the save is completed, BUSY output turns ON.
- Data can be sampled at high speed during logging as data is buffered to internal RAM on the ZS-DSU without the Memory Card being accessed. The size of data that can be saved continuously without any omissions is affected by the size of the internal RAM on the ZS-DSU.

The following tables show an approximate guide to sampling intervals and logging time:

• When only ZS-LDC only is connected

Number of Channels	Shortest Sampling Interval	Longest Logging Time
1	150 μ s	10 mins
2	200 μ s	6.5 mins
3	300 μ s	6.5 mins
4	350 μ s	5.5 mins
5	400 μ s	5 mins
6	450 μ s	5 mins
7	500 μ s	4.5 mins
8	550 μ s	4.5 mins
9	650 μ s	4.5 mins
10	700 μ s	4.5 mins

(typical examples)

• When connected to ZS-MDC

Number of Channels	Shortest Sampling Interval	Longest Logging Time
1	350 μ s	20 mins
2	400 μ s	12 mins
3	450 μ s	9 mins
4	500 μ s	8 mins
5	550 μ s	7 mins
6	600 μ s	6.5 mins
7	650 μ s	6 mins
8	650 μ s	5 mins
9	700 μ s	5 mins
10	750 μ s	4.5 mins

(typical examples)

● **Repeat Mode (continuous logging over an extended period)**

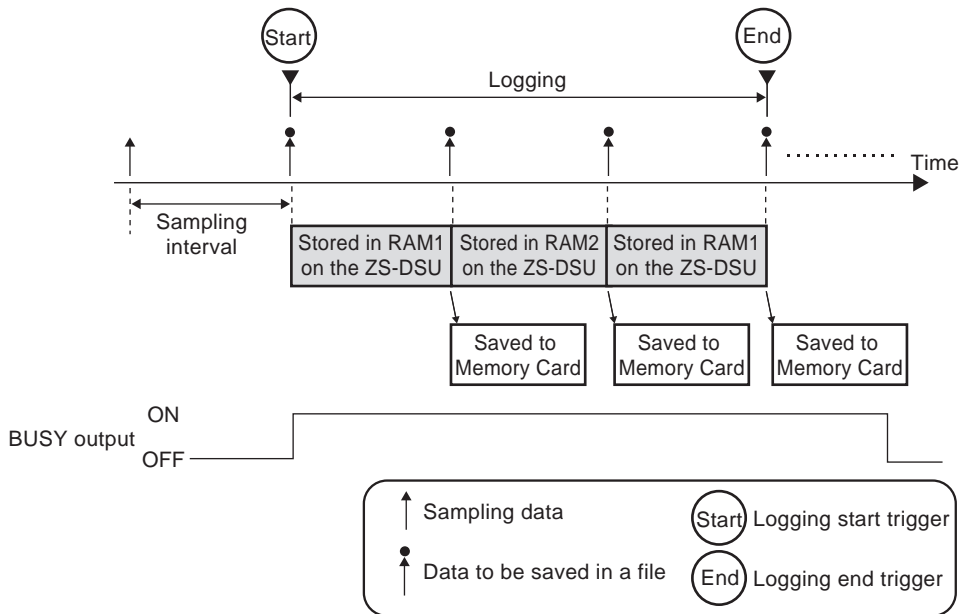

- Data can be continuously stored as long as there is enough space on the Memory Card as sampling is performed while the sampled data is being saved to Memory Card.
- Allow at least one second for the interval between the start trigger and the start trigger of the next repeat.

The following table shows an approximate guide to sampling intervals and logging time:

- In the case of a 64 MB Memory Card

Number of Channels	Shortest Sampling Interval	Longest Logging Time
1	10 ms	20 hours
2	10 ms	10 hours
4	10 ms	5 hours
9	10 ms	2 hours

(typical examples)

Setting the Data Format

Set the format that logged data is saved in.

► FUN Mode-[LOGING]-[FORMAT]

Setting	Description
I/ODATA	Sets whether or not to save flag information (header information) for judgment output, for example. Range: NONE, SAVE (default: NONE)
ALIGN (data alignment direction)	Set the direction that logging data is aligned. Range: COLUMN, ROW (default: COLUMN)
LF (line feed/row feed input)	Sets whether or not to perform line feed or row feed by line feed/row feed signals input externally. When "OFF" is set, line feeds or row feeds are performed each time. When "ON" is set, line feeds or row feeds are not performed until there is a line feed/row feed input. Range: OFF, ON (default value: OFF)

■ Data format

The format of logging data differs according to the direction of alignment and line feed input.

● Row direction

- I/O data save OFF, line feed input OFF

Count	Label A	Label B
	Data	Data
1	*****	*****
2	*****	*****
3	*****	*****
4	*****	*****
5	*****	*****
:		

is data acquired at 1 logging.

- I/O data save ON, line feed input OFF

Count	Label A	Label A	Label B	Label B
	Data	I/O	Data	I/O
1	*****	*****	*****	*****
2	*****	*****	*****	*****
3	*****	*****	*****	*****
4	*****	*****	*****	*****
5	*****	*****	*****	*****
:				

is data acquired at 1 logging.

- I/O data save OFF, line feed input ON

	Count	1	2	3	4	5	6	7	8
Label A	Data	*****	*****	*****	*****	*****	*****	*****	*****
Label B	Data	*****	*****	*****	*****	*****	*****	*****	*****
Label A	Data	*****	*****	*****	*****	*****	*****	*****	*****
Label B	Data	*****	*****	*****	*****	*****	*****	*****	*****
Label A	Data	*****	*****	*****	*****	*****	*****	*****	*****
Label B	Data	*****	*****	*****	*****	*****	*****	*****	*****
Label A	Data	*****	*****	*****	*****	*****	*****	*****	*****
Label B	Data	*****	*****	*****	*****	*****	*****	*****	*****
					Line feed	Line feed	Line feed	Line feed	Line feed
		Line feed	Line feed	Line feed					

is data acquired at 1 logging.

Stores data in ↓ direction (column direction) until line feed is input.

- I/O data save ON, line feed input ON

Count		1	2	3	4	5	6	7	8
Label A	Data	*****	*****	*****	*****	*****	*****	*****	*****
Label A	I/O	*****	*****	*****	*****	*****	*****	*****	*****
Label B	Data	*****	*****	*****	*****	*****	*****	*****	*****
Label B	I/O	*****	*****	*****	*****	*****	*****	*****	*****
Label A	Data	*****	*****	*****	*****	*****	*****	*****	*****
Label A	I/O	*****	*****	*****	*****	*****	*****	*****	*****
Label B	Data	*****	*****	*****	*****	*****	*****	*****	*****
Label B	I/O	*****	*****	*****	*****	*****	*****	*****	*****
Label A	Data	*****	*****	*****	*****	*****	*****	*****	*****
Label A	I/O	*****	*****	*****	*****	*****	*****	*****	*****
Label B	Data	*****	*****	*****	*****	*****	*****	*****	*****
Label B	I/O	*****	*****	*****	*****	*****	*****	*****	*****

Line feed Line feed Line feed

is data acquired at 1 logging.
Stores data in ↓ direction (column direction) until line feed is input.

● Line direction

- I/O data save OFF, line feed input OFF

Count		1	2	3	4	5	6
Label A	Data	*****	*****	*****	*****	*****	*****
Label B	Data	*****	*****	*****	*****	*****	*****

is data acquired at 1 logging.

- I/O data save ON, line feed input OFF

Count		1	2	3	4	5	6
Label A	Data	*****	*****	*****	*****	*****	*****
Label A	I/O	*****	*****	*****	*****	*****	*****
Label B	Data	*****	*****	*****	*****	*****	*****
Label B	I/O	*****	*****	*****	*****	*****	*****

is data acquired at 1 logging.

- I/O data save OFF, line feed input ON

Count	Label A	Label B	Label A	Label B	Label A	Label B	Label A	Label B
	Data	Data	Data	Data	Data	Data	Data	Data
1	*****	*****	*****	*****	*****	*****	*****	*****
2	*****	*****	*****	*****	*****	*****	*****	*****
3	*****	*****	*****	*****	*****	*****	*****	*****
4	*****	*****	*****	*****	*****	*****	*****	*****
5	*****	*****	*****	*****	*****	*****	*****	*****

Line feed
 Line feed
 Line feed

is data acquired at 1 logging.
Stores data in → direction (line direction) until line feed is input.

- I/O data save ON, line feed input ON

Count	Label A	Label A	Label B	Label B	Label A	Label A	Label B	Label B	Label A	Label A	Label B	Label B
	Data	I/O	Data	I/O	Data	I/O	Data	I/O	Data	I/O	Data	I/O
1	*****	*****	*****	*****	*****	*****	*****	*****	*****	*****	*****	*****
2	*****	*****	*****	*****	*****	*****	*****	*****	*****	*****	*****	*****
3	*****	*****	*****	*****	*****	*****	*****	*****	*****	*****	*****	*****
4	*****	*****	*****	*****	*****	*****	*****	*****	*****	*****	*****	*****
5	*****	*****	*****	*****	*****	*****	*****	*****	*****	*****	*****	*****

Line feed
 Line feed
 Line feed

is data acquired at 1 logging.
Stores data in → direction (line direction) until line feed is input.



Inputting a label to each line or row is handy for data identification and management.



Source settings p.3-15

Setting Banks

The ZS-DSU Series can hold up to four sets of settings. These settings can be switched externally when changing the device setup. A set of these settings is called a “bank”.

Switching banks

Bank 1 is selected as the default. Banks 2 and 4 are also available.



CHECK!

Banks can be switched from an external device by communication commands. For details on command formats, refer to the “Communication Command Reference” (provided separately).

► FUN Mode-[BANK]-[CHANGE]

Setting	Description
CHANGE	Selects the target bank. Range: BANK1, BANK2, BANK3, BANK4 (default: BANK1)

Clearing banks

“Clearing” initializes the settings of the currently selected bank.

► FUN Mode-[BANK]-[CLEAR]



CHECK!

Settings in [SYSTEM] and settings displayed in the RUN mode are not initialized.

External Bank Function

A maximum of 128 sets of bank data can be saved on Memory Card. Bank Data can be loaded from Memory Card to gang-mounted controllers as necessary when changing the device setup when there are not enough banks on the controller.

▶ RUN Mode-MENU Key-[BANK]

Setting	Description
CF→CONT (CF→CONTROLLER)	<p>Transfers the bank data on the Memory Card to the current bank of the specified channel.</p> <p>When [CF→CONT] is selected, the following setting items are subsequently displayed:</p> <ul style="list-style-type: none"> • FILE No. : BANK0 to BANK127 • REWRITE TARGET CH: 1CH to 14CH <p> The controller's current settings are changed. However, this does not mean that the content of the banks is saved. To save current settings, save them on the controller in question.</p> <p>CHECK!</p>
CONT→CF (CONTROLLER→CF)	<p>Saves the data of the specified bank of the specified channel as bank data on Memory Card.</p> <p>When [CONT→CF] is selected, the following setting items are subsequently displayed:</p> <ul style="list-style-type: none"> • SAVE SOURCE CH : 1CH to 14CH • SAVE SOURCE BANK : B1 to B8 (The number of banks to be specified depends on the target controller.) • FILE No. : BANK0 to BANK127

Setting the System Environment

Set the system environment.

Ejecting the Memory Card

Before you eject a Memory Card, be sure to perform this item.



How to Insert and Remove the Memory Card p.2-15

▶ FUN Mode-[SYSTEM]-[EJECT]

Setting	Description
OK	Readies the Memory Card so that it can be ejected.
CANCEL	Cancels Memory Card eject.

Saving setup data

Bank settings and system settings are saved internally on the Data Storage Unit.



- The settings of all banks are saved regardless of the currently selected bank No.
- After you have made or changed settings, be sure to save the setup data. All settings will be deleted if you turn the power OFF without saving the data. A message prompting you to save data will be displayed if you change a mode without saving data after you have changed settings.

▶ FUN Mode-[SYSTEM]-[SAVE]

Setting	Description
OK	Saves the setup data.
CANCEL	Does not save the setup data.

Initializing setup data

Return all bank settings and system settings to their factory settings.



The settings of all banks and system settings are initialized regardless of the currently selected bank No.

► FUN Mode-[SYSTEM]-[INIT]

Setting	Description
OK	Initializes the setup data.
CANCEL	Does not initialize the setup data.

Checking system information

This item displays the size of memory and the version of the Data Storage Unit system.

► FUN Mode-[SYSTEM]-[INFO]

Setting	Description
CF SIZE	Displays the size of the Memory Card
CYCLE	Displays the shortest measurement cycle.
VERSION	Displays the version of the Data Storage Unit system.

Setting the System Clock

Set the clock on the Data Storage Unit system.

► FUN Mode-[SYSTEM]-[CLOCK]

Setting	Description
DATE	Sets the date.
HOUR	Sets the hour.

Initializing the Memory Card

Format the Memory Card.

▶ FUN mode-[SYSTEM]-[CF]-[FORMAT]

Setting	Description
OK	Initializes the Memory Card.
CANCEL	Does not initialize the Memory Card.

Setting the save start No.

Logging files to be saved on Memory Card are automatically given a file name made up of a running number. That start No. can be changed.

Note that already existing Nos. will be overwritten if specified.

▶ FUN Mode-[SYSTEM]-[CF]-[FILE NO.]

Setting	Description
0 to 999	Sets the start No. The current start No. is displayed as the default start No.

Setting key lock

The key lock function disables all Data Storage Unit keys. Once the keys have been disabled, no key input will be accepted until the lock is released. This function is useful to prevent inadvertent changes to settings.

Moving to the key lock menu or moving between menu hierarchies by the MENU or ESC keys are possible even when the key lock function is ON.

▶ FUN Mode-[SYSTEM]-[KEYLOCK]

Setting	Description
OFF	Cancels the key lock function. (default value)
ON	Turns the key lock function ON.

Setting the display language

Set the display language of the LCD screen.

▶ FUN Mode-[SYSTEM]-[LANGUAG]

Setting	Description
Japanese	Displays menus in Japanese. (default value)
English	Displays menus in English.

Setting the Display Method

Set what you want to display on the Data Storage Unit during logging in the RUN mode. To set the display method, switch to the RUN mode and display the top menu.

Setting the display

Set what is displayed on the display in the RUN mode.

■ Number of digits past the decimal point

Set the number of display digits past the decimal point.

When five or less digits are set, the digits are disabled from the rightmost digit first.

▶ RUN Mode - MENU key-[DIGITAL]-[DOT]

Setting	Description
5th, 4th, 3rd, 2nd, 1st, 0	Sets the number of display digits past the decimal point. (default value: 3rd)

■ Setting the ECO display

Set the brightness of the display.

▶ RUN Mode - MENU key-[DIGITAL]-[ECO]

Setting	Description
NORMAL	Sets the display to normal brightness. (default value)
ECO	Suppresses the display brightness by reducing current consumption.
OFF	Turns the display OFF.

Setting the LCD display

Set how the LCD screen is displayed in the RUN mode.

■ Setting display ON/OFF

Set whether or not to display the LCD screen.

▶ RUN Mode-MENU key-[LCD]-[ON/OFF]

Setting	Description
ON	Displays the LCD screen at all times. (default value)
AUTOOFF	Turns the LCD screen display OFF when no operations are performed for one minute.
OFF	Turns the LCD screen OFF. (This setting is valid only in the RUN mode. Note, however, that pressing the MENU key displays the display customize menu.)

■ Setting the backlight ON/OFF

Set whether or not to turn the LCD screen's backlight ON or OFF.

▶ RUN Mode-MENU key-[LCD]-[B.LIGHT]

Setting	Description
ON	Turns the LCD screen backlight ON at all times. (default value)
AUTOOFF	Turns the backlight OFF when no operations are performed for one minute.
OFF	Turns the LCD screen backlight OFF.

■ Customizing the LCD display

Set this item to display customized characters on the LCD screen.

▶ RUN Mode-MENU key-[LCD]-[CUSTOM]

Setting	Description
ON/OFF	Set this item to ON to display characters set at [CUSTOM] on the LCD screen. (default value: OFF)
CUSTOM	Use this setting to edit characters to display on the LCD screen. (max. 16 digits) <ul style="list-style-type: none"> • Call up the initial character of each character group using function keys 1 to 4. (Other signals are assigned to the later half of each group.) <ol style="list-style-type: none"> 1: A to Z 2: a to z 3: KANA 4. Numbers, ; , , < , = , > , ? , @ • Switch the characters in order using the UP or DOWN key. • Move the digits by the LEFT or RIGHT key. • To clear a character, select a space.

HELP

Display Help for the functions assigned to the SET or ESC keys in the RUN mode.

- ▶ RUN Mode-MENU Key-[HELP]

MEMO

Section 4

EXTERNAL I/O

☒ Alarm Output	4-2
Selecting the Measurement Data Source	4-2
Setting Judgment Conditions	4-3
☒ RS-232C Input/Output	4-4
RS-232C Specifications	4-4
Setting the Communication Specifications	4-5

Alarm Output

On the ZS-DSU, you can set original judgment conditions to measurement data acquired from controllers. These judgment conditions can be used as alarm outputs (HH output, LL output).

 Wiring the I/O Cable p.2-11

Selecting the Measurement Data Source

Set the source and hysteresis to be judged when the judgment results of the logging data (measurement data) are to be output as an alarm.

► FUN Mode-[I/O SET]-[JUDGE]

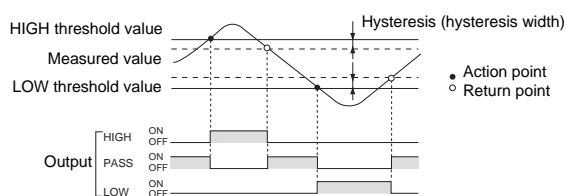
Setting	Description
SOURCE	Set the source to be judged. Range: SourceA to SourceN
HYS	Set the hysteresis width. <div style="text-align: center;">  <p>Setting range: 0 to 999.999 (default value: 20μm)</p> </div>

Setting Judgment Conditions

Set both HIGH and LOW threshold values for outputting alarms. There are three judgment outputs: HIGH, PASS and LOW.

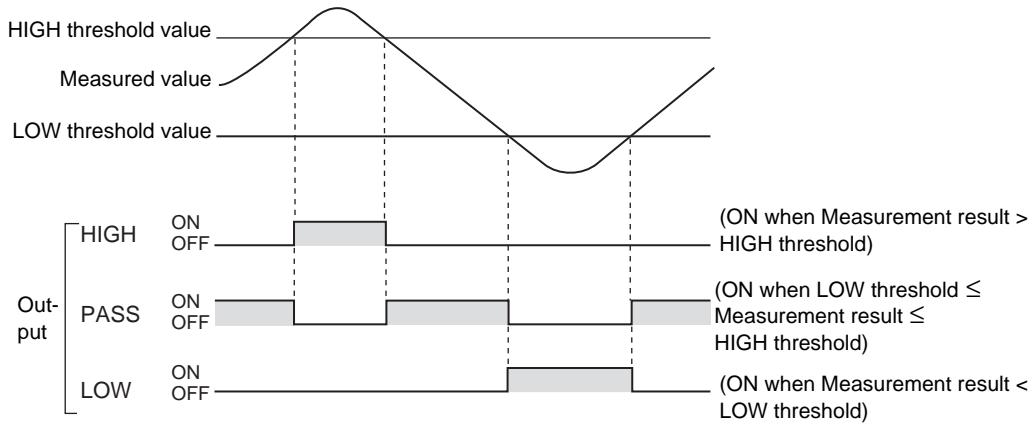

Hysteresis (hysteresis width) can also be set to threshold values. Set hysteresis when judgments are unstable to prevent chattering.

CHECK!



Selecting the Measurement Data Source p.4-2

► TEACH Mode

Method	Details
DIRECT IN (L/R/UP/DOWN keys)	The threshold values can be set by directly inputting numerical values.

RS-232C Input/Output

The Data Storage Unit is also provided with an RS-232C port for connection to a personal computer that does not have a USB port. This allows communications with external devices using the OMRON proprietary communication protocol CompoWay/F or non-procedure (NORMAL). For details on command formats, refer to the "Communication Command Reference" (provided separately).

RS-232C Specifications

■ Connector pin assignments

An exclusive connector is used for the connector.

An RS-232C cable compatible with the exclusive connector is provided.

Recommended part: ZS-XRS2 (cable length: 2 m)

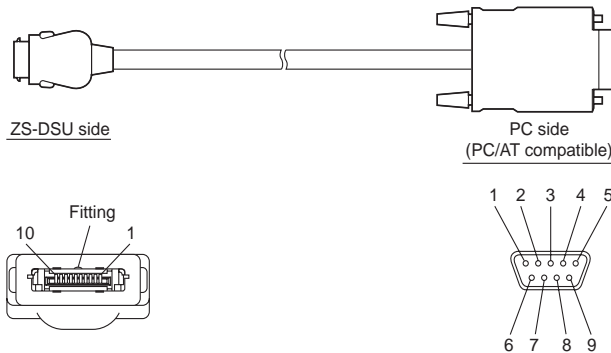

Signal name	Pin No.
NC	1
SD(TXD)	2
RD(RXD)	3
RS(RTS)	4
CS(CTS)	5
NC	6
NC	7
NC	8
SG(GND)	9
NC	10

Pin No.	Signal name
1	NC
2	RD(RXD)
3	SD(TXD)
4	NC
5	SG(GND)
6	NC
7	RS(RTS)
8	CS(CTS)
9	NC

Setting the Communication Specifications

Set the RS-232C communications specifications.

Match the communication specifications of the ZS-DSU to those of the external device.

▶ FUN Mode-[SYSTEM]-[COM]

Setting		Range
RS-232C	LENGTH	8BIT, 7BIT (default value: 8BIT)
	PARITY	NON, OFF, EVEN (default value: NON)
	STOP	1BIT, 2BIT (default value: 1BIT)
	BAUDRAT	9600, 19200, 38400, 57600, 115200 (default value: 38400)
	DELIMIT	CR, LF, CR+LF (default: CR)
MODE		COMPWAY, NORMAL (default: COMPWAY)
NODE (node No.)		0 to 16 (default value:0)
		 The node No. refers to the connection group No. as seen from the host device (PLC). Not only the ZS Series but other multiple devices are connected to the PLC. The No. assigned to devices connected to a PLC such as this is referred to as a node No. CHECK!









For details on communication protocol, refer to the "Communication Command Reference" (provided separately). For the Communication Command Reference, please contact your OMRON representative.

MEMO

Section 5

APPLICATION SETTING EXAMPLES

 Periodic Continuous Logging	5-2
 Multi-point Simultaneous Logging	5-5
 Logging the Shape for Each Detected Workpiece	5-8
 Simultaneous Logging Images and Measured Values for Multiple Controllers	5-11
 Save NG Images for 1 Day	5-14
 Logging of Images Before and After NG	5-16

Periodic Continuous Logging

In this setting example, data such as measured sheet thickness data is logged periodically over an extended period of time.

The following describes an example of how to measure the thickness of a sandwiched sheet by a ZS-MDC and two ZS-LDC and log data over five hours at 100 ms intervals. Set up logging on the ZS-DSU and ZS-MDC.

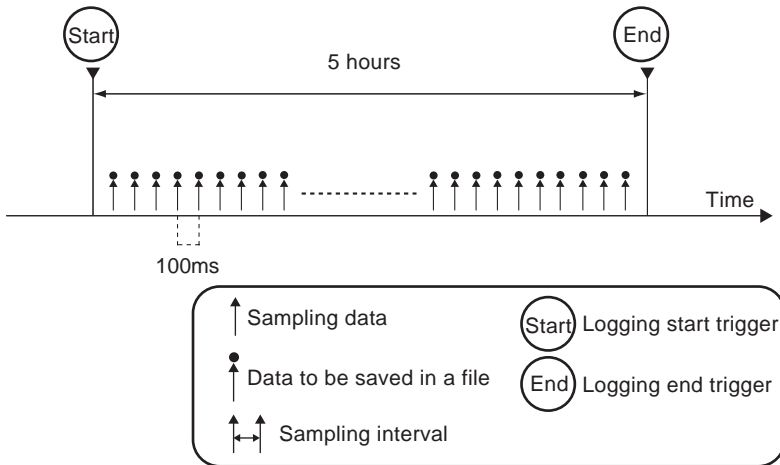
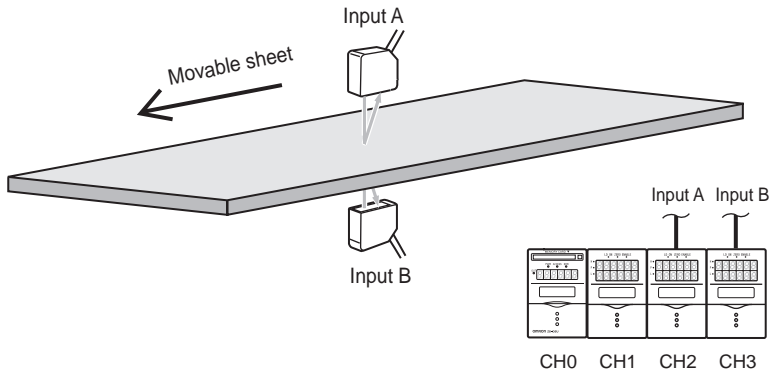

For details on how to connect and install the Sensor Heads and controllers, refer to the “ZS-L Series User’s Manual”.

First of all, set the image logging to OFF and the following to the ZS-MDC. For details on operation and setup methods, refer to the User's Manual for the ZS-MDC.

Setting item		Setting
SEL CH	Input A	2CH
	Input B	3CH
TASK1	OPERA-TION	Expression type
		THICKNESS
		Calculation parameter X
		Input A
		Calculation parameter Y
		Input B

ZS-DSU settings

▶ FUN Mode-[LOGING]-[SOURCE]-[SourceA]

1. Select the source to save data from.

Set the following details to source A:

SELECT : TASK1

SAVE : ON

LABEL : (any letters)



▶ FUN Mode-[LOGING]-[TRIGGER]-[START]-[BUTTON]

2. Select the [BUTTON] to use as the start trigger.

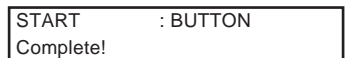

▶ FUN Mode-[LOGING]-[TRIGGER]-[END]-[HOUR]

3. Set the end trigger to 5 hours.



Section 5 Periodic Continuous Logging

▶ FUN Mode-[LOGING]-[SAMPLE]

4. Set the sampling conditions.

MODE : REPEAT
STOP : NONE
FILE : NEW
CYCLE : 100 ms

1 MODE	2 STOP
3 FILE	4 CYCLE

▶ RUN Mode

5. Press the ↑UP key once to switch to start trigger standby state.

Available MB
Waiting ↓ : STOP

6. Press the ↑UP key once again to start logging.

Available MB
Waiting ↑ : TRIG



CHECK! Logging is continued until five hours elapse. Logging can be forcibly ended midway by pressing the ↓DOWN key.

Multi-point Simultaneous Logging

This is an example of how to set the simultaneously logging for multiple measurement data (e.g. flatness measurement) at a specific timing.

The following describes an example of how to measurement flatness using the ZS-MDC and four ZS-LDCs, and perform logging in synchronous with the logging signals of the ZS-MDC.

Set up logging on the ZS-DSU and ZS-MDC.

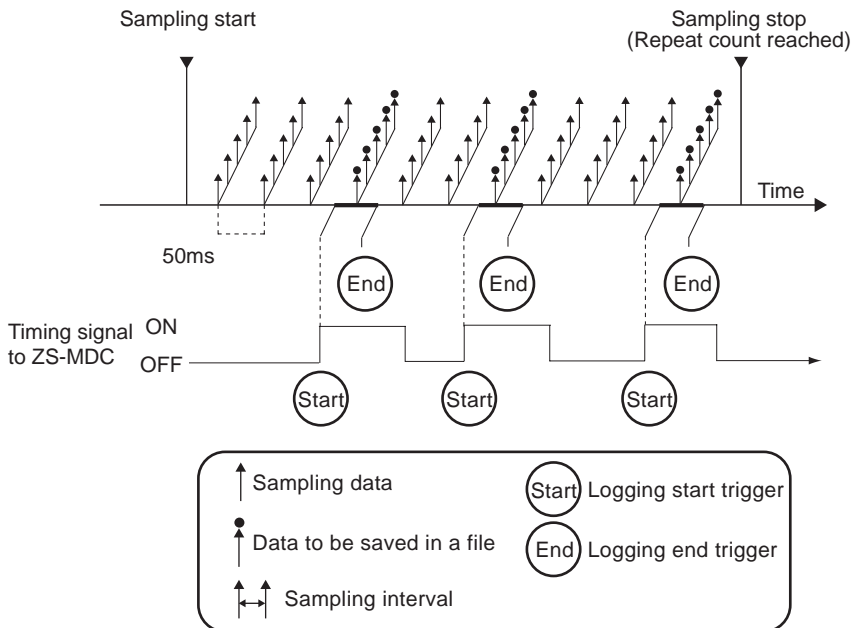
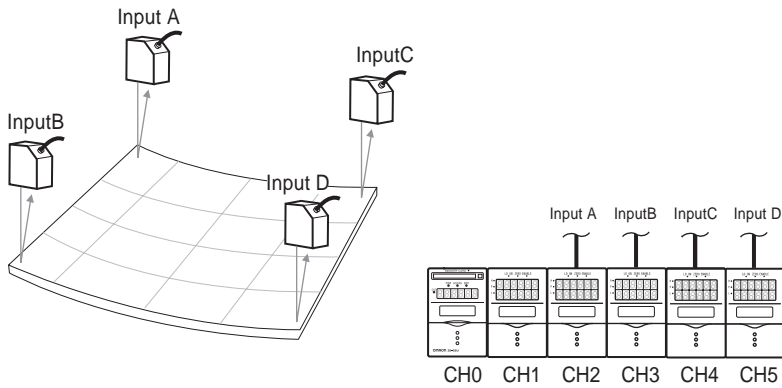

For details on how to connect and install the Sensor Heads and controllers, refer to the "ZS-L Series User's Manual."

Section 5 Multi-point Simultaneous Logging

First of all, set the image logging to OFF and the following to the ZS-MDC. For details on operation and setup methods, refer to the User's Manual for the ZS-MDC.

Setting item		Setting
SEL CH	Input A	2CH
	Input B	3CH
	Input C	4CH
	Input D	5CH
TASK1	OPERATION	Expression type MAX-MIN (all input A to D are valid)

ZS-DSU settings

► FUN Mode-[LOGING]-[SOURCE]-[SourceA]

1. Select the source to save data from.

1 SourceA	2 SourceB
3 SourceC	←→

Set the following details to sourceA:

SELECT : Input A
SAVE : ON
LABEL : (any letters)

Set [Input B] to [Input D] in the same way to [SourceB] to [SourceD].
Set [TASK1] to [SourceE].

► FUN Mode-[LOGING]-[TRIGGER]-[START]-[I/O]

2. Set the start trigger.

1 SOURCE	2 I/O SEL
3 ACTIVE	4 DELAY

SOURCE : SourceA
I/O SEL : IN0
ACTIVE : OFF→ON

► FUN Mode-[LOGING]-[TRIGGER]-[END]-[QUANT]

3. Set the number of data points to use as the end trigger to one point.

POINT :	000001
←→DIG ↑ ↓ VAL	SETOK

▶ FUN Mode-[LOGING]-[SAMPLE]

4. Set the sampling conditions.

1 MODE	2 STOP
3 FILE	4 CYCLE

MODE : REPEAT
 STOP : Desired number of repeated logs
 FILE : ADD
 CYCLE : 10 ms

▶ RUN Mode

5. Either press the ↑UP key once or input the external input signal (IN2) to switch to start trigger standby state.

6. Logging is started when the state of the timing input of ZS-MDC changes from OFF to ON.



CHECK!

- Set any desired value as the sampling interval. To set the deviation from the trigger input to a minimum, set the fastest speed 10 ms.
- The input to be used as the trigger must be set to an ON state longer than the sampling interval.
- Allow at least one second for the interval between the start trigger and the start trigger of the next repeat.

Logging the Shape for Each Detected Workpiece

This is an example of data obtained by sampling for each workpiece (e.g. shape logging) at high speed.

The following describes an example of how to measure at the maximum speed of the ZS-LDC, and log all measurement data for the duration that the timing signal of ZS-LDC is ON.

Set up logging on the ZS-DSU and ZS-LDC.

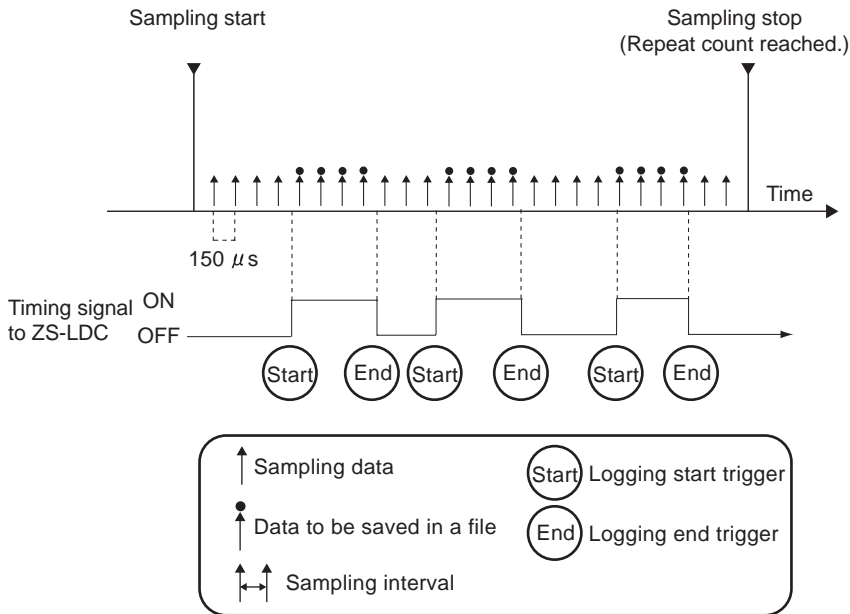
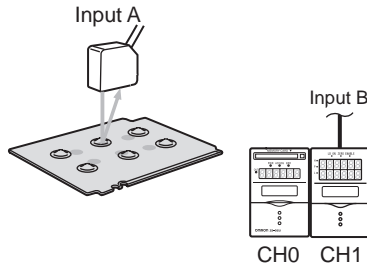

For details on how to connect and install the Sensor Heads and controllers, refer to the "ZS-L Series User's Manual."

First of all, set the image logging to OFF and the following to the ZS-LDC. For details on operation and setup methods, refer to the User's Manual for the ZS-LDC.

Setting item		Setting
SENSING	MODE	HI-SPEED

ZS-DSU settings

▶ FUN Mode-[LOGING]-[SOURCE]-[SourceA]

1. Select the source to save data from.



Set the following details to source A:

SELECT : 1CH

SAVE : ON

LABEL : (any letters)

▶ FUN Mode-[LOGING]-[TRIGGER]-[START]-[EXT]

2. Set the start trigger.



EDGE : OFF→ON

▶ FUN Mode-[LOGING]-[TRIGGER]-[END]-[EXT]

3. Set the end trigger.

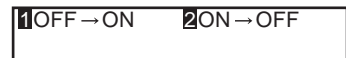

EDGE : ON→OFF

▶ FUN Mode-[LOGING]-[SAMPLE]

4. Set the sampling conditions.

1 MODE	2 STOP
3 FILE	4 CYCLE

MODE : 1SHOT
STOP : Desired number of repeated logs
FILE : NEW
CYCLE : 0.15 ms

▶ RUN Mode

5. Either press the ↑UP key once or input the external input signal (IN2) to switch to start trigger standby state.

6. Logging is performed for the duration that the ZS-LDC timing input is ON.



- Logged data can be saved at the fastest speed of 150μs by setting ONE SHOT. However, the time that data can be saved continuously varies. In the case of this example, the time becomes roughly 10 minutes.
- When ONE SHOT is set, saving to Memory Card begins when the start trigger changes to the end trigger. For this reason, the start trigger is not applied while logged data is being written to the Memory Card. Do not input the next start trigger until the BUSY output turns OFF.

Simultaneous Logging Images and Measured Values for Multiple Controllers

Setting example where ZFV is used for simultaneous logging of results measured with 1 camera and multiple controllers.

All points are logged at line adjustment for checking fluctuation trends of measured value and image conditions, and can be used for checking the optimum threshold level and analyzing inconsistencies.

The following describes setting examples when logging these images and measured values here when 2 tests are performed with 1 camera simultaneously.

Use ZS-DSU to set logging conditions.

Max. 128 loggings

Square workpiece edge test
 (This does not test the positioning, but whether the workpiece fits into the area)

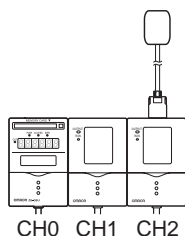
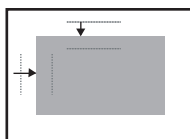

Specify the amplifier unit where a sensor head is connected for the target channel of image log. A ZFV without a sensor head cannot be specified.

CHECK!

ZS-DSU settings

▶ FUN Mode-[IMAGE]-[SOURCE]

1. Set the channel where logging images.

1SEL CH	2IMGSAVE
---------	----------

IMAGE SAVE : ON
SELECT CH : 2CH

▶ FUN Mode-[LOGING]-[SOURCE]

2. Set the channel where logging measured values.

1SELECT	2SAVE
3LABEL	

Set the following details to source A:

SELECT : 1CH
SAVE : ON
LABEL : (any letters)

Set the following details to source B:

ASSIGN : CH2
SAVE : ON
LABEL : (any letters)

▶ FUN Mode-[LOGING]-[TRIGGER]-[START]-[BUTTON]

3. Select the [BUTTON] to use as the start trigger.

START	: BUTTON
Complete!	

▶ FUN Mode-[LOGING]-[TRIGGER]-[END]-[BUTTON]

4. Select the [BUTTON] to use as the end trigger.

END	: BUTTON
Complete!	

▶ FUN Mode-[LOGING]-[SAMPLE]

5. Set the sampling conditions.

MODE : 1SHOT (Latest)
 STOP : Trigger count (1)
 FILE : NEW
 INTERVAL : ALL

1MODE	2STOP
3FILE	4CYCLE

▶ FUN Mode-[LOGING]-[FORMAT]

6. Set data format.

I/ODATA : SAVE
 ALIGN : COLUMN
 LINE FEED : OFF

1I/ODATA	2ALIGN
3LF	

▶ RUN mode

7. Press the ↑ UP key one time to switch to start trigger standby state.

8. Press the ↑ UP key again to start logging.

9. Input TRIG to ZFV of CH2, and measure.

10. Press the ↓ DOWN key to finish logging.

Logging data is saved to the memory card.

11. Check logging image and data.

Images and data are associated using ID numbers.



CHECK!

When more than 128 data are logged, data from 129 is not saved.

Save NG Images for 1 Day

Setting example where only NG images measured by ZFV are logged. Logging images and their measured values can be logged.

Log NG images for day 1 to check for inconsistency trends.

The following describes setting examples when logging these NG images and measured values here when 1 test is performed with 1 camera.

Use ZS-DSU to set logging conditions.

Max. 128 loggings

Search detection

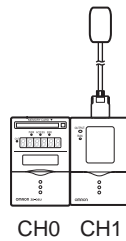
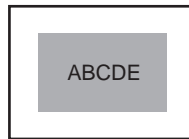

ZS-DSU settings

▶ FUN Mode-[IMAGE]-[SOURCE]

1. Set the channel where logging images.

IMAGE SAVE : ON
SELECT CH : 1CH

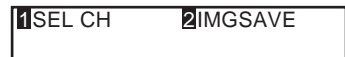

▶ FUN Mode-[LOGING]-[SOURCE]-[Source A]

2. Set the channel where logging measured values.

SELECT : 1CH
SAVE : ON
LABEL : (any letters)

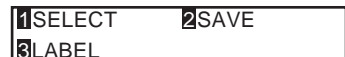

▶ FUN Mode-[LOGING]-[TRIGGER]-[START]

3. Set the end trigger to 5:00am.

HOUR : (Time for system start)

1 WINDOW	2 I/O
3 HOUR	↔

▶ FUN Mode-[LOGING]-[TRIGGER]-[END]

4. Set the end trigger.

QUANT : 128

1 QUANT	2 TIME
	↔

▶ FUN Mode - [LOGING]-[SAMPLE]

5. Set the sampling conditions.

MODE : 1SHOT (CURRENT)
 STOP : NONE
 FILE : NEW
 CYCLE : NG

1 MODE	2 STOP
3 FILE	4 CYCLE

▶ FUN Mode - [LOGING]-[FORMAT]

6. Set data format.

I/ODATA : (Optional)
 ALIGN : (Optional)
 LINE FEED : OFF

1 I/ODATA	2 ALIGN
3 LF	

▶ RUN mode

7. Press the ↑ UP key one time, or input external input signal (IN2) to switch to start trigger standby state.

8. Start NG image logging from specified time.

9. When logging of NG image reaches 128 images, logging ends and data is saved to the memory card. When there are less than 128 NGs, input external input signal (IN3) to end logging and save to the memory card.

10. Check logging image and data.

Images and data are associated using ID numbers.

Logging of Images Before and After NG

Setting example for logging before and after NGs measured by ZFV. Logging images before and after NG enables checking of inconsistency occurrence process.

The following describes setting examples when logging images and measured values before and after NG here when 3 tests are performed with 1 camera.

Use ZS-DSU to set logging conditions.

Max. 128 loggings

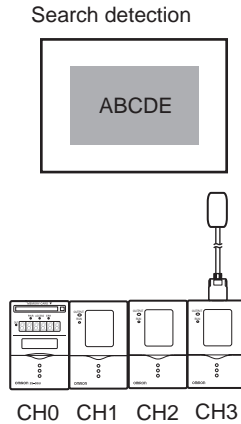

Set the following to CH3 ZFV beforehand. For details on operation and setup methods, refer to the User's Manual for the ZFV.

Setting item			Setting
SYS2	LINKSET	OUTPUT	ALL
	OUTPUT	ON STATUS	NG ON

ZS-DSU settings

▶ FUN Mode-[IMAGE]-[SOURCE]

1. Set the channel where logging images.

1SEL CH	2IMGSAVE
---------	----------

IMAGE SAVE : ON
SELECT CH : 3CH

▶ FUN Mode-[LOGING]-[SOURCE]

2. Set the channel where logging measured values.

1SELECT	2SAVE
3LABEL	

Set the following details to source A:

SELECT : 1CH
SAVE : ON
LABEL : (any letters)

Set the following details to source B:

SELECT : 2CH
SAVE : ON
LABEL : (any letters)

Set the following details to source C:

SELECT : 3CH
SAVE : ON
LABEL : (any letters)

▶ FUN Mode-[LOGING]-[TRIGGER]-[START]-[I/O]

3. Set the start trigger.

1SOURCE	2I/O SEL
3ACTIVE	4DELAY

SOURCE : Source C
I/O SELECT : OUT0
ACTIVE : OFF→ON
DELAY : No. of images checked in reverse

▶ FUN Mode-[LOGING]-[TRIGGER]-[END]

4. Select the [QUANT] to use as the end trigger.

1 QUANT	2 TIME	↔
---------	--------	---

QUANT : (No. of total images to be saved before and after NG)



When saving 127 images before NG and 10 images after NG,
 Start Trigger Delay: -127 images

CHECK! End Trigger Data Count: 138 images (127 images + NG image + 10 images)

▶ FUN Mode-[LOGING]-[SAMPLE]

5. Set the sampling conditions.

1 MODE	2 STOP
3 FILE	4 CYCLE

MODE : 1SHOT (CURRENT)
 STOP : NONE
 FILE : NEW
 CYCLE : ALL

▶ FUN Mode-[LOGING]-[FORMAT]

6. Set data format.

1 I/ODATA	2 ALIGN
3 LF	

I/ODATA : (Optional)
 ALIGN : (Optional)
 LINE FEED : OFF

▶ RUN mode

7. Press the ↑ UP key one time, or input external input signal (IN2) to switch to start trigger standby state.

8. Log images before and after NG.

9. Store specified data count to the memory card.

10. Check logging image and data.

Images and data are associated using ID numbers.

Section 6

APPENDIX

☒ Troubleshooting	6-2
☒ Error Messages and Countermeasures	6-3
☒ Q&A	6-4
☒ Glossary	6-4
☒ Specifications and External Dimensions	6-5
☒ Version Up Information	6-10
☒ INDEX	6-11
☒ Revision History	6-16

Troubleshooting

This section describes countermeasures for temporary hardware problems. Check the malfunction in this section before sending the hardware for repair.

Problem	Probable cause and possible countermeasure	Pages
Device restarts during operation.	<ul style="list-style-type: none"> • Is the power supply device connected correctly? 	p.2-11
Judgments are not output to external device.	<ul style="list-style-type: none"> • Are all cables connected correctly? • Is the signal line disconnected? • Are reset inputs short-circuited? 	p.2-11
No input signal received	<ul style="list-style-type: none"> • Are all cables connected correctly? • Is the signal line disconnected? 	p.2-11
No communications with personal computer	<ul style="list-style-type: none"> • Is the USB cable connected correctly? • Is the RS-232 cable connected correctly? 	p.4-4
The main display remains on [-----].	<ul style="list-style-type: none"> • Is the controller assigned as the source in a non-measurement state? • Does the display show the remaining number of points even though the number of data is not set to the trigger end conditions? • Does the display show the remaining time even though the time is not set to the trigger end conditions? 	p.3-8
Error indicator is lit.	<ul style="list-style-type: none"> • Check to see if the Memory Card is inserted correctly. • Check the remaining amount of space on the Memory Card. 	p.2-15 p.3-8

Error Messages and Countermeasures

Common error messages

Display Details		Cause	Countermeasure
LCD screen	NO MEDIA	The Memory Card is not inserted.	Insert the Memory Card.
	Insufficient	There is not enough remaining space in the Memory Card.	<ul style="list-style-type: none"> • Replace the Memory Card. • Delete unwanted files saved on the Memory Card. • Format the Memory Card.
	Dead Battery	The backup battery for the clock has run down.	• Contact your OMRON representative.
	Setting failed	The preset setting values are out of range.	• Set the values within the allowable setting range.

Error messages when the external bank function is used

Display Details		Cause	Countermeasure
LCD screen	File not found	The specified bank file is not on the Memory Card.	Change bank file No. to an existing file name.
	DATA ERROR	The specified bank file is in error.	Select the correct bank file.
	Trans failed	Bank file communications error	Check the connection between the controllers.

When all digits on the displays blink

Display Details		Cause	Countermeasure
LCD screen	SYSTEM ERROR CONNECT	The controller is not connected.	Connect the Controller.
	SYSTEM ERROR BANK DATA	Internal bank data is in error	Hold the UP key down for 3 seconds, and then hold the DOWN key down for 3 seconds. The Data Storage Unit is turned ON again and restored after it is initialized.
	SYSTEM ERROR MAIN COM	Internal error	Turn the Data Storage Unit ON again.

Others

Display Details		Cause	Countermeasure
LCD screen	Disp range Error	The measurement result exceeds the number of displayed digits.	Change the decimal point digit setting.

Q&A

Question	Answer
What is the minimum sampling interval?	This changes according to the number of assigned sources and mode.  p.3-26
Can I use third-party Memory Cards?	Operation of some types has been verified. Contact your OMRON representative.

Glossary

Term	Explanation
Memory Card	Storage media for saving logging data CompactFlash is used on the Data Storage Unit.
CSV file	An abbreviation for text delimited with commas. In this text file, data elements are delimited by a comma, which allows the data to be browsed on general-purpose spreadsheet software.

Specifications and External Dimensions

Data Storage Unit

ZS-DSU11/DSU41

(Unit: mm)

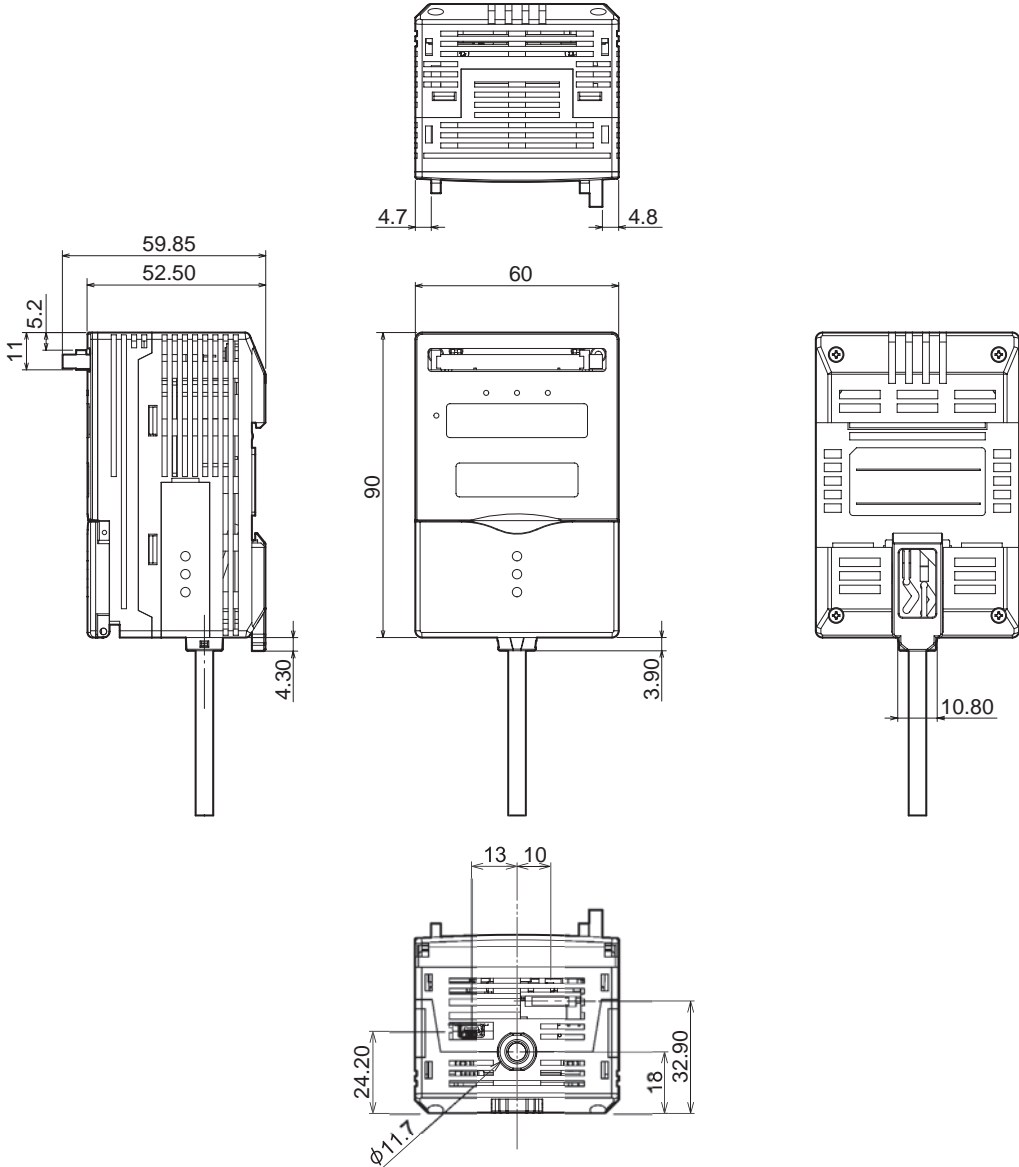

Item		ZS-DSU11	ZS-DSU41
I/O type		NPN type	PNP type
Number of connected Sensor Heads		Cannot be connected	
Number of connected controllers		Max. 15 units (ZS-MDC: 1 unit, ZS-LDC: 9 units, ZS-ZFV' 5 units) (The Controller Link Unit is needed for gang-mounting.)	
Connectable controllers		ZS-LDC__, ZS-MDC__, ZFV-A__	
External I/F	Connection method		Serial I/O is connector type. Otherwise, prewired (standard cable length: 2 m)
	Serial I/O	USB2.0	1 port, FULL SPEED [12 Mbps], MINI-B
		RS-232C	1 port, max. 115200 bps
	Output		HIGH/PASS/LOW 3 outputs NPN open collector, DC30V 50 mA max. residual voltage1.2V or less
Input		ON: Short-circuited with 0V terminal or 1.5 V max. OFF: Open (leakage current: 0.1 mA max.)	ON: Supply voltage short-circuited or within supply voltage -1.5 V OFF: Open (leakage current: 0.1 mA max.)
Data resolution		32 bits	
Functions	Trigger function		Start/end trigger can be set individually. External trigger/data trigger (self trigger)/time trigger
	Other functions		External bank function, alarm output function, image logging function Save data format customize function, clock function
Status indicators		OUT(orange), PWR(green), ACCESS(green), ERR(red)	
Segment display		8-segment green display, 6 digits	
LCD		16 digits x 2 rows, color of characters: green, resolution per character: _5 x 8 pixel matrix	
Setting input	Setting keys		Direction keys (UP/DOWN/LEFT/RIGHT), SET key, ESC key, MENU key, function keys (1 to 4)
	Slide switch		Threshold switch (H/L 2-state) MODE switch (FUN/TEACH/RUN 3-state)
Power supply voltage		21.6 V to 26.4 V (including ripple)	
Current consumption		0.5 A max.	
Insulation resistance		Across all lead wires and controller case: 20 MΩ (by 250 V megger)	
Dialectic strength		Across all lead wires and controller case, 1000 VAC, 50/60 Hz, 1 min	
Noise immunity		1500 V peak-to-peak, pulse width 0.1 μs/1 μs, rising edge: 1 ns pulse	
Vibration resistance (destructive)		10 to 150 Hz, 0.7 mm double amplitude, 80 min each in X, Y, and Z directions	
Shock resistance (destructive)		300 m/s ² 3 times each in six directions (up/down, left/right, forward/backward)	
Ambient temperature		Operating: 0 to 50°C Storage: 0 to +60°C (with no icing or condensation)	
Ambient humidity		Operating and storage: 35% to 85% RH (with no condensation)	
Materials		Case: Polycarbonate (PC)	
Weight		Approx. 280 g (excluding packing materials and accessories)	

Panel Mount Adapters

ZS-XPM1/XPM2

When mounting on a panel

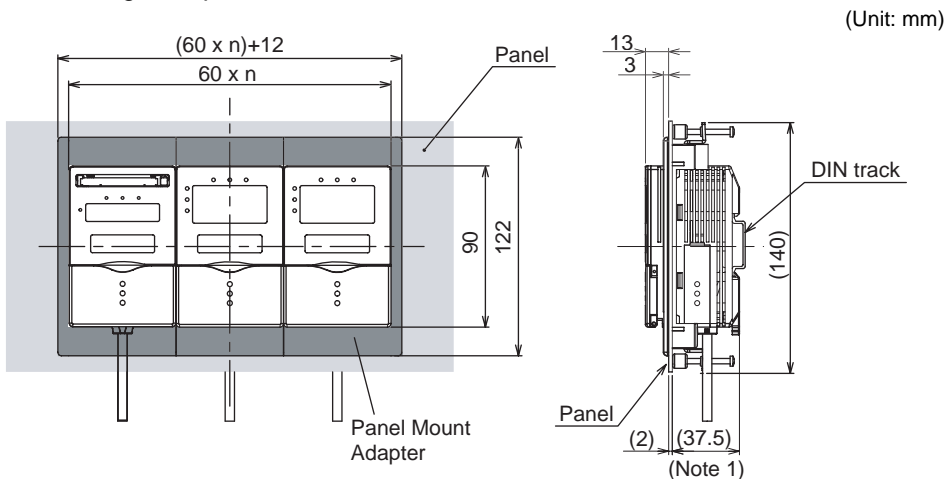

Note 1: Dimensions are shown for a panel thickness of 2.0 mm.

Panel cutout dimensions

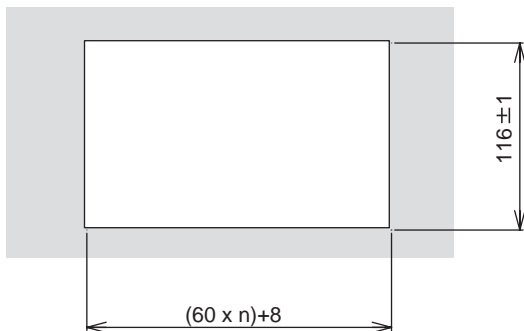

n: number of gang-mounted controllers (1 to 11)

Item	ZS-XPM1 (for 1st unit)	ZS-XPM2 (for 2nd unit onwards)
Appearance		
Applicable controller	ZS Series	
Vibration resistance	10 to 150 Hz, 0.7 mm double amplitude, 80 min each in X, Y, and Z directions	
Shock resistance	300 m/s ² 3 times each in six directions (up/down, left/right, forward/backward)	
Materials	Polycarbonate (PC), etc.	
Weight	Approx. 50 g	

RS-232C Cable for Connecting to a Personal Computer

ZS-XRS2

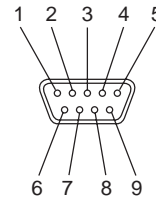
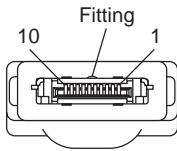
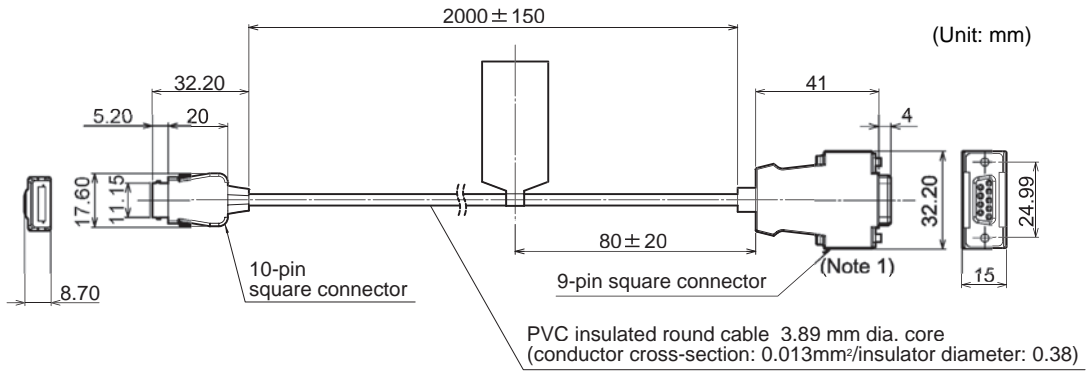

Signal name	Pin No.
NC	1
SD(TXD)	2
RD(RXD)	3
RS(RTS)	4
CS(CTS)	5
NC	6
NC	7
NC	8
SG(GND)	9
NC	10

Pin No.	Signal name
1	NC
2	RD(RXD)
3	SD(TXD)
4	NC
5	SG(GND)
6	NC
7	RS(RTS)
8	CS(CTS)
9	NC

Note 1: Connector is socket type.

Item	ZS-XRS2
Applicable controller	ZS Series
Ambient temperature	Operating: 0 to +50°C, Storage: -15 to +60°C (with no icing or condensation)
Ambient humidity	Operating and storage: 35% to 85% RH (with no condensation)
Dialectic strength	1,000 VAC, 50/60 Hz for 1 min
Insulation resistance	100 MΩ (by 500 VDC megger)
Vibration resistance	10 to 150 Hz, 0.7 mm double amplitude, 80 min each in X, Y, and Z directions
Shock resistance	300 m/s ² 3 times each in six directions (up/down, left/right, forward/backward)
Materials	Cable sheath: PVC
Weight	Approx. 50 g

Controller Link Unit

ZS-XCN

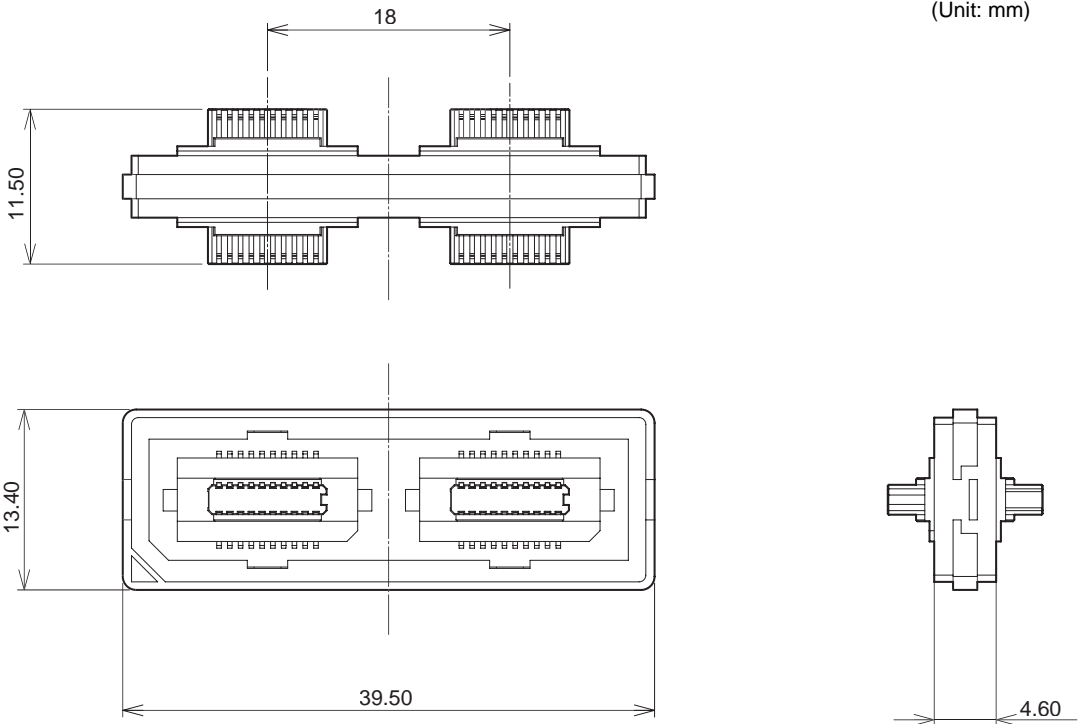

Item	ZS-XCN
Applicable controller	ZS Series, ZFV Series
Ambient temperature	Operating: 0 to +50°C, Storage: -15 to +60°C (with no icing or condensation)
Ambient humidity	Operating and storage: 35% to 85% RH (with no condensation)
Vibration resistance	10 to 150 Hz, 0.7 mm double amplitude, 80 min each in X, Y, and Z directions
Shock resistance	300 m/s ² 3 times each in six directions (up/down, left/right, forward/backward)
Materials	Polycarbonate (PC), etc.
Weight	Approx. 10g

Version Up Information

This section describes the revisions made to the software.

■ Ver 1.00 to Ver 2.00

Description of Change	Pages
Gang-mounted ZFV for logging image data enabled.	-
Use of external bank functions for ZFV enabled.	-

INDEX

A

ACTIVE	3-24
I/O	3-20
ALARM	4-2
ALIGN	3-31
ASSIGN	
DATA SLOPE	3-18, 3-22
DATA WINDOW	3-19, 3-23
IMAGE	3-16
AUTOOFF	3-40
Available	
DATA	3-8
MB	3-8
TIME	3-8
TRIG	3-8

B

B.LIGHT	3-40
BANK	
External	3-34
CLEAR	3-33
CHANGE	3-33
Basic Configuration	1-9
BUSY output	2-12
BUTTON	
END	3-21
START	3-16

C

CF access indicator	1-12
CF power indicator	1-12
COM	4-5
CompoWay/F	4-4
CONDITIONS	3-19, 3-23
Control keys	3-5
Controller Link Unit	
Connection	2-4
Specifications and Dimensions	6-9
Coupler	1-13
CUSTOM	3-40
CYCLE	3-36

D

DATA (SLOPE)	3-18, 3-22
DATA POINTS	3-25
Data Storage Unit	
Attaching the ferrite core	2-3

Installation	2-4
Part Names	1-12
Specifications and Dimensions	6-5
DATA WINDOW	3-23
DELAY	
DATA SLOPE	3-18
DATA WINDOW	3-19
EXT INPUT	3-17
DIN track	2-4
DIRECT IN	4-3
display	
CUSTOM	3-39
DOT	3-39

E

ECO	3-39
EDGE	
DATA SLOPE	3-18, 3-22
EXT INPUT	3-17, 3-22
End trigger	3-21
ERR output	2-11
Error indicator	1-12
EXT	
END	3-22
START	3-17
External Bank Function	3-34

F

Ferrite core	
Data Storage Unit	2-3
FILE	3-28
File configuration	1-16
FORMAT	
LOGGING DATA	3-31
FUN Mode	3-5

H

HELP	3-41
HIGH output	2-11
HOUR	3-25
HYS	4-2

I

I/O	3-20, 3-24
I/O cable	2-11
I/O circuit diagrams	2-13
I/O DATA	3-31
IMAGE	3-16

IN0 to 3 2-12

J

Judgment Conditions 4-3

K

KEYLOCK 3-37

L

LABEL 3-15

LANGUAG 3-38

Latest 3-26

LCD 3-40

LCD screen 3-5

LINE FEED 3-31

Line feed input 2-12

Logging

 Data format 1-16, 3-31

 End trigger 1-14

 How it works 1-14

 Start trigger 1-14

Logging source 3-15

Logging Time 3-29

LOW output 2-11

LOWER LIMIT 3-19, 3-23

M

Memory Card

 EJECT 3-35

 FORMAT 3-37

 How to Insert and Remove 2-15

 INIT 3-37

 remaining size 3-8

 SIZE 3-36

MODE 3-19, 3-23

Mode Switch 3-4

N

NG SAVE 3-27

Non-procedural 4-4

NORMAL 3-26

O

ONE SHOT 3-28

OUT indicator 1-13

OUT0 to 4 2-11, 2-12

Output cable 2-11

P

PASS output 2-11

PROTOCOL 4-4

R

REPEAT 3-28

RS-232C

 cable external dimensions 6-8

 cable wiring 4-4

 Communications

 Specifications 4-5

 Connector 1-13

RUN mode 3-8

S

sampling interval 1-14, 3-29

sampling start 1-14, 2-12

sampling stop 1-14, 2-12, 3-27, 3-28

SAVE 3-35

SAVING DATA 3-9

START NO. 3-37

Start trigger 3-16

Start trigger standby state 1-14

STOP 3-26

Stopped state 1-14

SYSTEM 3-35

T

TEACH Mode 3-10

Threshold Selector Switch 1-13

TIME 3-21, 3-24

Timing input

 wiring 2-12

trigger

 end 3-21

 Start 3-16

U

UPPER LIMIT 3-19, 3-23

USB port 1-13

W

wiring 2-11

MEMO

MEMO

MEMO

Revision History

A manual revision code appears as a suffix to the catalog number at the bottom of the front and back covers of this manual.

Cat. No. Z210-E1-04

↑
Revision code

Revision code	Date	Revised contents
01	October 2004	Original production
02	March 2005	Functions added as per software version upgrade (Ver2.00)
02A	March 2012	Additions for Notice for Korea Radio Law
03	August 2015	Additions corresponding to change of EN standard
04	June 2016	Changes the type of memory cards

OMRON Corporation Industrial Automation Company
Kyoto, JAPAN

Contact: www.ia.omron.com

Regional Headquarters

OMRON EUROPE B.V.

Sensor Business Unit

Carl-Benz-Str. 4, D-71154 Nufringen, Germany
Tel: (49) 7032-811-0/Fax: (49) 7032-811-199

OMRON ASIA PACIFIC PTE. LTD.

No. 438A Alexandra Road # 05-05/08 (Lobby 2),
Alexandra Technopark,
Singapore 119967
Tel: (65) 6835-3011/Fax: (65) 6835-2711

OMRON ELECTRONICS LLC

2895 Greenspoint Parkway, Suite 200
Hoffman Estates, IL 60169 U.S.A.
Tel: (1) 847-843-7900/Fax: (1) 847-843-7787

OMRON (CHINA) CO., LTD.

Room 2211, Bank of China Tower,
200 Yin Cheng Zhong Road,
PuDong New Area, Shanghai, 200120, China
Tel: (86) 21-5037-2222/Fax: (86) 21-5037-2200

Authorized Distributor:

© OMRON Corporation 2004 All Rights Reserved.
In the interest of product improvement,
specifications are subject to change without notice.

Cat. No. Z210-E1-04

0616