

F200 Visual Inspection System

Operation Manual

Produced March 1994

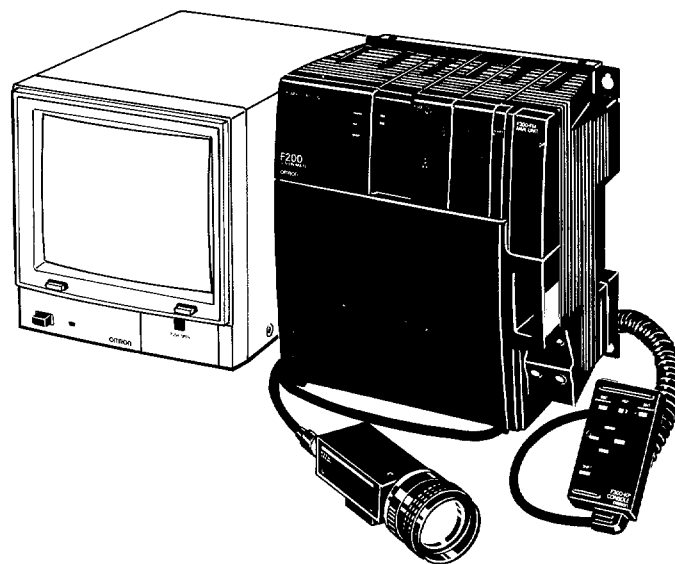

Notice:

OMRON products are manufactured for use according to proper procedures by a qualified operator and only for the purposes described in this manual.

The following conventions are used to indicate and classify precautions in this manual. Always heed the information provided with them. Failure to heed precautions can result in injury to people or damage to the product.

DANGER! Indicates information that, if not heeded, is likely to result in loss of life or serious injury.

WARNING Indicates information that, if not heeded, could possibly result in loss of life or serious injury.

Caution Indicates information that, if not heeded, could result in relative serious or minor injury, damage to the product, or faulty operation.

OMRON Product References

All OMRON products are capitalized in this manual. The word "Unit" is also capitalized when it refers to an OMRON product, regardless of whether or not it appears in the proper name of the product.

The abbreviation "PLC" means Programmable Controller (Programmable Logic Controller) and is not used as an abbreviation for anything else.

Quick BASIC is a registered trademark of Microsoft Corporation.

IBM and IBM PC/AT are registered trademarks of International Business Machines Corporation.

Visual Aids

The following headings appear in the left column of the manual to help you locate different types of information.

Note Indicates information of particular interest for efficient and convenient operation of the product.

1, 2, 3... 1. Indicates lists of one sort or another, such as procedures, checklists, etc.

© OMRON, 1994

All rights reserved. No part of this publication may be reproduced, stored in a retrieval system, or transmitted, in any form, or by any means, mechanical, electronic, photocopying, recording, or otherwise, without the prior written permission of OMRON.

No patent liability is assumed with respect to the use of the information contained herein. Moreover, because OMRON is constantly striving to improve its high-quality products, the information contained in this manual is subject to change without notice. Every precaution has been taken in the preparation of this manual. Nevertheless, OMRON assumes no responsibility for errors or omissions. Neither is any liability assumed for damages resulting from the use of the information contained in this publication.

TABLE OF CONTENTS

SECTION 1	
Basic Operation	1
1-1 Features	2
1-2 Terminology	3
1-3 Basic Console Operation	7
1-4 Menu Configuration and Operations	9
SECTION 2	
Installation	25
2-1 System Configuration	26
2-2 System Setup	28
2-3 Power and Ground Wiring	35
2-4 Installation Environment	37
2-5 Connecting Peripheral Devices	39
2-6 External Dimensions	45
SECTION 3	
Menu Operation Flow	49
3-1 Inspection for Cans of the Wrong Type	50
3-2 Positioning for Tightening Screws	57
3-3 Inspection of Folded Ends of Packages	65
SECTION 4	
Operations	73
4-1 Scenes	74
4-2 Displays	80
4-3 Cameras	90
4-4 Binary	105
4-5 Windows	110
4-6 Conditions	120
4-7 Measurement	140
4-8 System	157
4-9 Tools	171
SECTION 5	
Inspection, Maintenance and Troubleshooting	191
5-1 Maintenance	192
5-2 Inspection	193
5-3 Troubleshooting	193
Appendices	
A Specifications	201
B Measurement Time Charts	219
C RS-232C Data Transmission Program Example	223
D Menu Hierarchy Diagrams	227
Index	231
Revision History	235

About this Manual:

This manual describes the installation and operation of the F200 Visual Inspection System and includes the sections described below.

Please read this manual carefully and be sure you understand the information provided before attempting to install and operate the F200 Visual Inspection System.

Section 1 describes the F200 Visual Inspection System, the F200's features, basic key and menu operations, and provides the basic information needed before performing detailed operations.

Section 2 describes the installation of the F200 Visual Inspection System, system setup, power and grounding requirements, environmental considerations important to the operation of the system, and provides explanations of peripheral device connections.

Section 3 describes the order of operations used for setting inspection data. Three examples are presented which illustrate the variations required by different applications.

Section 4 describes detailed key operations and their execution using the System menus.

Section 5 provides the information essential for maintaining and inspecting the F200. In addition, the F200 displays error messages which identify many types of abnormal system conditions. This section provides troubleshooting charts that can be used to minimize downtime and facilitate quick, smooth error correction.

The **Appendices** provide specifications, measurement time charts, RS-232C data transmission program example, and menu hierarchy diagrams.

<p>WARNING Failure to read and understand the information provided in this manual may result in personal injury or death, damage to the product, or product failure. Please read each section in its entirety and be sure you understand the information provided in the section and related sections before attempting any of the procedures or operations given.</p>

SECTION 1

Basic Operation

This section describes the F200 Visual Inspection System, and provides the basic information needed before performing detailed operations.

1-1	Features	2
1-2	Terminology	3
1-3	Basic Console Operation	7
1-3-1	Names and Functions of Console Keys	7
1-3-2	Key Operations	8
1-3-3	Inputting from RS-232C	8
1-4	Menu Configuration and Operations	9
1-4-1	Basic Menu Operations	10
1-4-2	Selecting Menus	11
1-4-3	Setting Data	12
1-4-4	Inputting Numbers	15
1-4-5	Inputting Characters	17
1-4-6	Editing Input Characters	19
1-4-7	Displaying Help Messages	21
1-4-8	Displaying the F200 Version	21
1-4-9	Starting and Quitting	22

1-1 Features

The F200 Visual Inspection System provides powerful support to the automation of visual inspection processes.

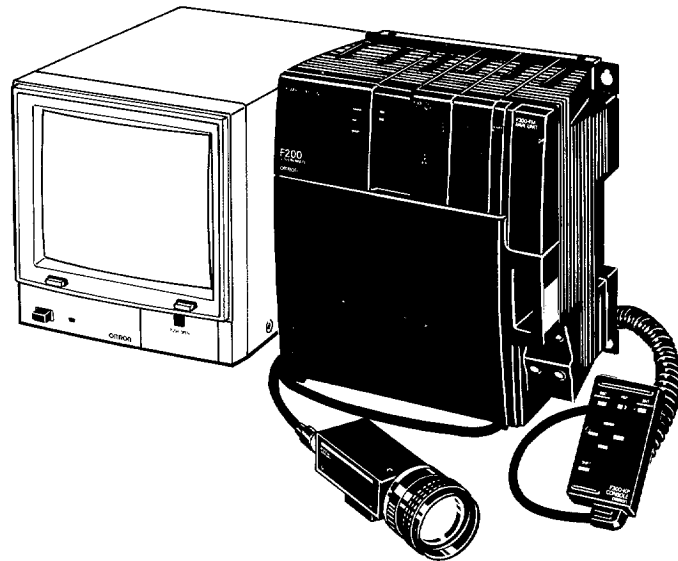

It greatly facilitates visual inspection and positioning in a wide range of industrial applications, such as, for example, labelling containers, distinguishing between different items, checking the directional orientation of components, positioning items for assembly, and so on.

The F200 provides a number of features that make it not only powerful but easy to use.

System Configuration Adapted to Applications

After the required Units have been selected, the system can be configured to suit the application. The compact size allows for easy installation almost anywhere.

Expanded Range of Applications

The following advanced features open up a wider range of possible applications.

- Real-time position displacement compensation responds to workpiece positioning.
- Eleven types of filtering expand the range of inspections.
- The binary level can be set to any of 256 levels. Upper and lower limits can be set to produce clear binary images.
- Up to 1,800 items (including position displacement compensation) can be measured per minute.
- Measurement can be carried out at four places simultaneously.
- Measurement results can be processed with the four arithmetic operations for output.

Simple Execution of Sophisticated Functions

Inspection data can be set by means of simple menu operations. Menus can be operated by means of eight Console keys. Help messages serve to further simplify operations.

Simplified Maintenance

Fine adjustments can be carried out even during measurement operations. Up to 128 measurement results can be displayed. Important data can be saved to a personal computer via a memory card and RS-232C. The measuring data can be changed simply by switching the scene number.

1-2 Terminology

Area

An image of a measured object can be put in binary and the area can then be measured by counting the black and white pixels. This function is used for showing the size of a figure. In an F200 System, it is the white pixels that are taken as the area.

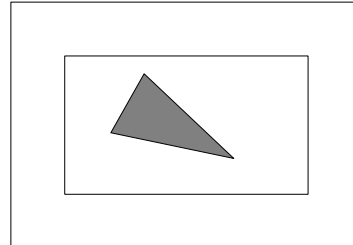

Axis Angle

When a binary image is graphically replaced by an equivalent oval, the angle of that oval's line of upside direction is called the axis angle. It is used for showing the position of an object. The axis angle is expressed within a range of 0° to 179.999° , with the X axis as 0° and the angle increasing in a positive direction toward the Y axis. The axis angle cannot be computed, however, for figures (such as circles and squares) which have no directionality.

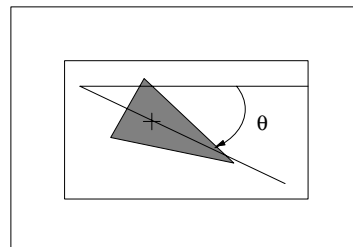

Binary

The image signals received from the cameras are output to the monitor as raw (monochrome) images. In order to simplify and speed up processing and measurement, those raw images can be converted to binary images of black (0) and white (1). In order to convert an image to binary, the binary level must first be set. The binary level is taken as the criteria for determining black and white pixels. (See Fig. 1 below.)

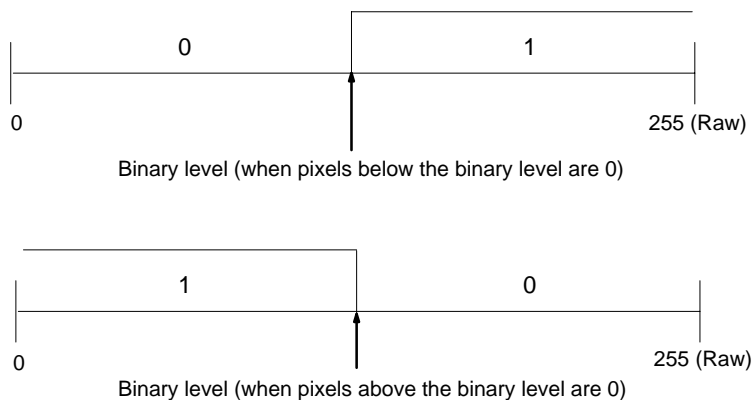

Fig. 1 Pure Binary

For the image to be measured by the F200, that portion of the image that is to be measured must be set as white pixels. Upper and lower limits can be set for binary, so half-tone binary is also possible. (See Fig. 2 below.) In addition, the

density distribution of a raw image can be analyzed and the binary lower limit can be set automatically.

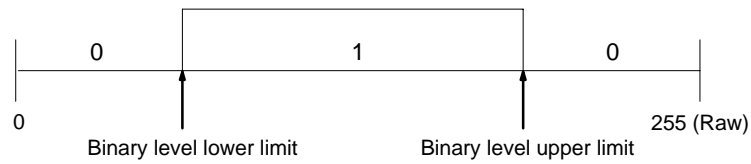
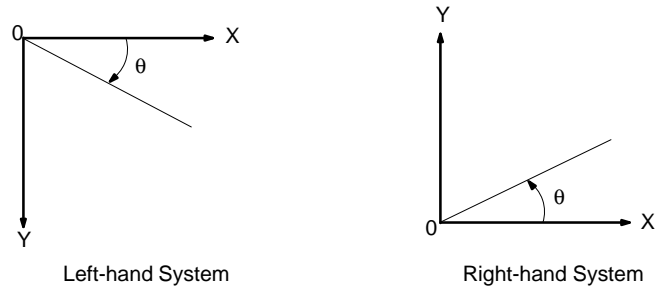

Fig. 2 Half-tone Binary

Calibration

Calibration is the conversion of measurement results to actual dimensions. It is used when outputting, as actual dimensions, the position and area information regarding the object of measurement. In order to execute calibration, the following data must be prepared in advance.

- Coordinate systems (right and left). The actual coordinate system has a right-hand system and a left-hand system. When calibration is executed, one or the other of these coordinate systems must be designated for use.



- Discrepancy between the points of origin at the camera coordinate system and the actual coordinate system (camera X origin and Y origin). The camera coordinate system is the coordinate system used internally by the F200. Taking the upper left of the screen as the point of origin, points to the right constitute the X axis and points in a downward direction constitute the Y axis. The angle, therefore, is positive in the clockwise direction. The actual coordinate system is the coordinate system of the measured object. When calibration is executed, the measurement results are converted to the actual coordinates for output.
- Inclination between the camera coordinate system and the actual coordinate system (the camera angle). The camera angle indicates the extent to which the mounted camera is inclined with respect to the actual coordinates of the measured object. For the F200, the camera angle is positive in the counterclockwise direction when the right-hand coordinate system is designated, and positive in the clockwise direction when the left-hand coordinate system is designated.

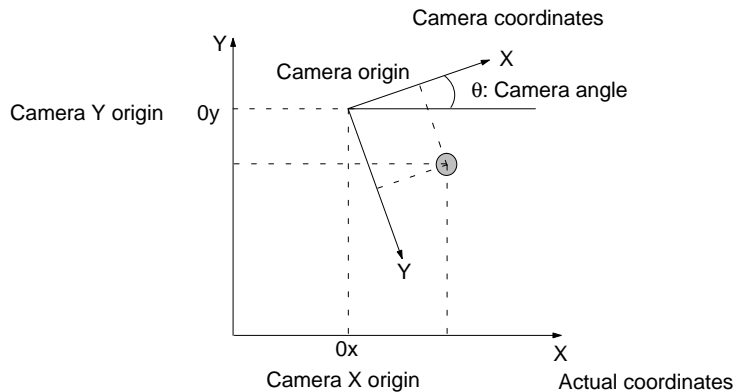

- Actual dimensions per pixel at the camera coordinate system (magnification). The magnification specifies the ratio at which individual pixels in the camera coordinates will correspond to actual dimensions. For example, if 10 mm in length is expressed as 100 pixels on the screen, then the magnification is $10 \text{ (mm)}/100 \text{ (pix)} = 0.1 \text{ (mm/pix)}$.

Camera Synchronization

When images taken by cameras are input to the visual system, the images cannot be properly transmitted unless the cameras and the visual system are operating under the same timing. It is necessary, therefore, to synchronize the cameras and the F200 System. There are two methods for synchronizing cameras: internal synchronization and external synchronization. In addition, the standards for synchronization signals between the cameras and the F200 must match. At the F200, the synchronization method to be used is determined for each type of camera, and it is set automatically for each camera that is connected. The user need only correctly set the synchronization method at the cameras to match the F200.

Center of Gravity

The term "center of gravity" refers to a point that could be represented in the following way. If a binary image could be cut out like a piece of cardboard of uniform thickness, and balanced while supported by a single point, the position of that point would be called the center of gravity. For example, for a circle that point would be the center of the circle, while for a rectangle it would be the cross point of the two diagonal lines. The center of gravity is used for indicating the position of an object.

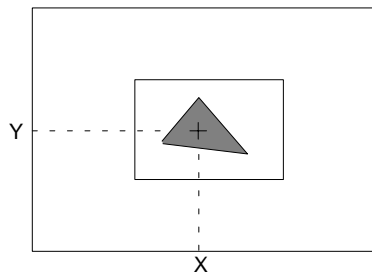
**Extension Tube**

An extension tube is a ring that can be inserted between the lens and the camera when taking close-up images. It compensates for the amount that the lens focus adjustment range may be exceeded when it is necessary to move the camera fairly close to a small object of measurement.

Normal Camera

Normal cameras are the video cameras that are most widely used. They take images at one field per 1/60 second and one frame per 1/30 second, and can be used for taking images of objects that are motionless or moving at low speed. For taking images of objects moving at high speed, a strobe or a shutter camera must be used.

Optical Chart

Optical charts are charts that show the relationship between lenses, camera distance, extension tube thickness, and field of vision. Logarithms are written for the field of vision along the horizontal axis and the camera distance along the vertical axis. Optical charts can be used as references for selecting the lenses appropriate for particular measured objects. Optical charts vary according to the camera's CCD size, so be sure to use an optical chart that conforms to the camera that is being used.

Pixel

Images are configured of many minute elements, called pixels, that are illuminated individually. An F200 screen consists of 484 vertical and 512 horizontal pixels. In menu displays and in this manual, pixels are often abbreviated as "pix."

Resolution

Resolution is used to express the capability of an optical system, or other imaging system, of making clear and distinguishable the separate parts or components of an object. In an F200 System, a single camera has 512 x 484 pixels for

resolution of approximately 250,000 pixels. Therefore, when the field of vision on the screen is 512 (mm) x 484 (mm), the resolution is 1 (mm/pix).

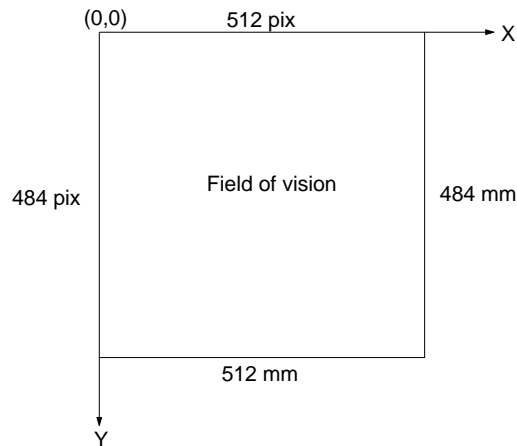

The images of two cameras can be simultaneously input to the F200. Therefore, if an object is too large for a single camera, two cameras can be used to take the picture, in which case it is possible to increase the apparent resolution to approximately 500,000 pixels by dividing the picture into two pieces.

Shutter Camera

A shutter camera is a video camera that can provide still images of objects moving at high speed. The exposure time can be radically shortened in comparison with a normal camera (i.e., 1/5,600 second, compared to 1/30 second for a normal camera), and images can be taken with very little blurring.

Strobe

Strobes are used when taking images of objects moving at high speed. If images of such objects are taken using a normal camera and no strobe, blurring occurs due to the long exposure time. The strobe serves, in effect, to shorten the exposure time to the short time of the strobe flash, and thus allows images to be taken without blurring. The periods between strobe flashes must be completely dark to prevent exposure from occurring.

1-3 Basic Console Operation

Menus are operated by means of the console. Be sure to familiarize yourself with console operations before actually operating menus. Menus can also be operated by means of RS-232C channel 0.

1-3-1 Names and Functions of Console Keys

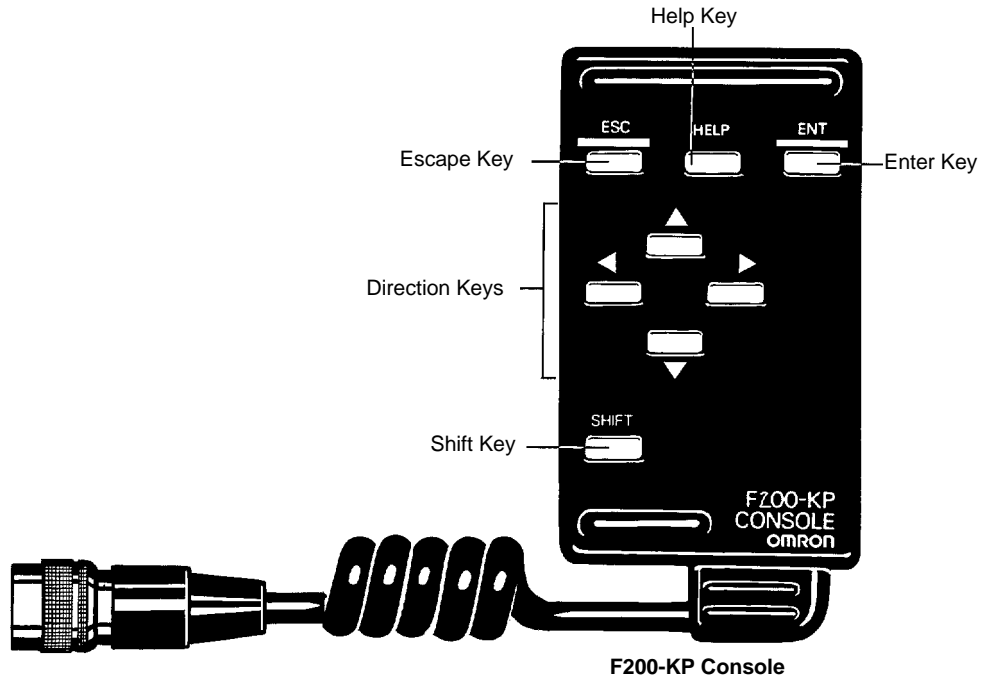

1-3-2 Key Operations

Display	Name	Function
HELP	Help Key	Displays help messages. In the measuring screen, the measurement result log will be displayed.
ESC	Escape Key	Interrupts processing and returns the user to the previous menu display.
ENT	Enter Key	Executes cursor position functions. When a menu is being displayed, it displays the next level menu at the cursor position. When data is being input, it sets the data.
▲	Up Key	These two keys move the cursor up and down.
▼	Down Key	
▶	Right Key	These two keys move the cursor to the right and left. In the measurement screen, they switch display cameras.
◀	Left Key	
SHIFT	Shift Key	Has no effect when pressed by itself. It must be used in combination with another key.
SHIFT + ESC		If there is an extended menu, the extended menu is displayed. The version of the F200 is displayed in the basic screen. The adjustment menu for the displayed image will be displayed.
SHIFT + HELP (See note.)		Displays the binary level adjustment menu in a measurement screen.
SHIFT + ▲ / ▼ / ▶ / ◀ (See note.)		When creating graphics, the Shift Key can be pressed simultaneously with any of the four direction keys to move the cursor at high speed (10 pixels at a time).
SHIFT + ▲ / ▼		In the binary level setting screen, this reverses black and white. In the measurement screen, it switches the displayed scene.
SHIFT + ▶ / ◀		When numbers are being entered, this changes the number by multiples of 10 of the least significant digit.
SHIFT + ENT (See note.)		When numbers and characters are being entered, this clears (to 0) the values that were entered. In the binary level setting screen, it automatically sets the binary level. In the measurement screen, it displays the judgement criteria adjustment menu.

Note This operation can only be executed by means of the console keys, and not by RS-232C input.

1-3-3 Inputting from RS-232C

The keys (codes) for inputting from RS-232C are shown below with their corresponding console keys.

Console key	RS-232C input code
ESC	CTRL + [(\$1B)
HELP	CTRL + A(\$01)
ENT	CTRL + M(\$0D)
▲	CTRL + E(\$05)
▼	CTRL + X(\$18)
◀	CTRL + S(\$13)
▶	CTRL + D(\$04)
SHIFT + ESC	TAB(\$09)

Always begin operation from channel 0. If operation is begun from a channel 1, menu operation will not be possible. Set the communications specifications for

channel 0. (For details, refer to 4-8-2 *Setting RS-232C Communications Specifications.*)

It is not necessary to set RS-232C to ON by means of the M. Meas/I. Input device.

1-4 Menu Configuration and Operations

Initial Screen

When the F200 is started up, the following screen will be displayed first. This is called the Initial Screen. It shows the F200 version and copyright, in addition to the Camera I/F Unit that is mounted and the type of camera being used. Verify that the Camera I/F Unit and type of camera are correct. (For further information, refer to *Checking the Initial Screen* under 1-4-9 *Starting and Quitting.*)

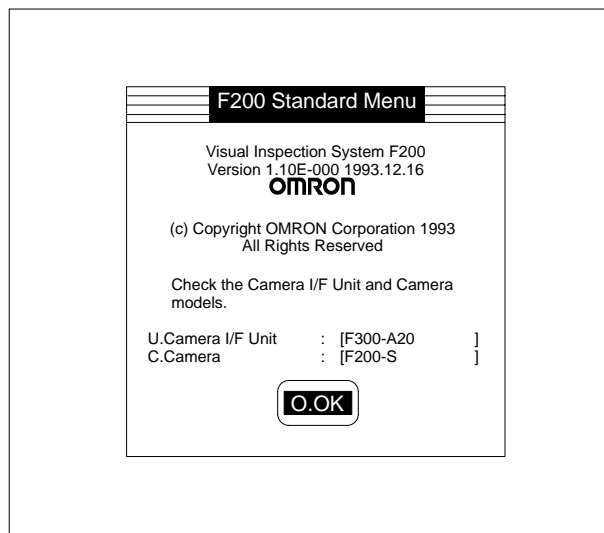

Basic Screen

After the Initial Screen operation has been completed, the following screen will be displayed. This is called the Basic Screen. It serves as the basis for menu operations, and can execute various functions.



1-4-1 Basic Menu Operations

Main menu bar
F200 functions are comprised within nine basic menus.

Menu box
Menus are displayed in menu boxes.

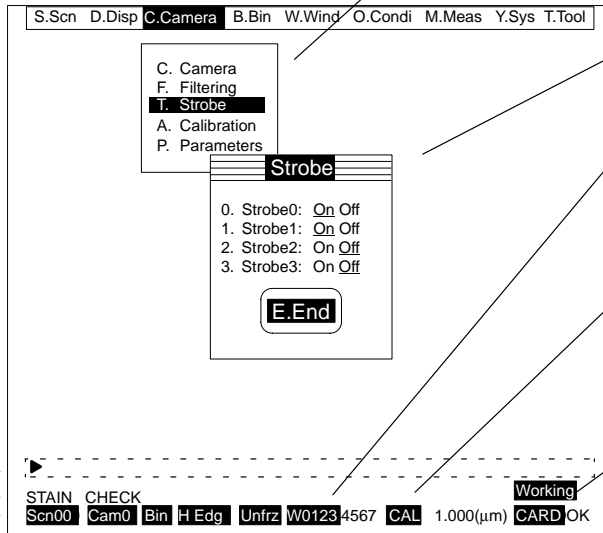

Dialog box
Used for setting data.

Window number
The number of the window currently being displayed is shown in reverse video.

Calibration display
When the calibration operation is set to ON, the calibration data is displayed.

Operation display
Displayed during processing.

Status line
Displays information on the scene and window that is presently displayed and its displayed method.

Scene comment
When a comment is input to the scene that is presently displayed, the comment will be displayed.

Comment line
Shows procedure, etc.

Memory card battery voltage check
When a memory card is installed, the battery voltage is checked and the results are displayed.
Battery voltage sufficient: OK
Battery voltage too low: NG
Memory card not installed: --

Image display method
The display method for the currently displayed image is shown.
Unfreeze: Unfrz
Freeze: Frz
Set to freeze by image load: Fram0

Filtering
The type of filtering for the current display is shown.
Set to OFF: Nothing displayed.
Set for filtering: H Edg (Type of filtering shown.)

Display image
The type of image for the current display is shown.
Original image or image after filtering: Raw
Binary image: Bin

Camera number
The camera number for the current display is shown.

Scene number
The scene number for the current display is shown.

Message Boxes

Confirmation messages (such as the one shown below) and error messages are displayed.

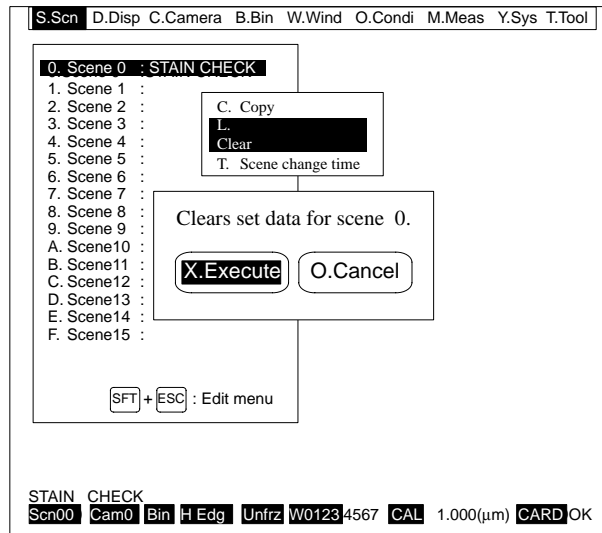

1-4-2 Selecting Menus

F200 menus are hierarchical, so it is necessary to move through related menus to select the desired menu. The procedure for moving through the menu hierarchy is explained here. For an overview of the entire menu hierarchy, refer to Appendix D.

- 1, 2, 3...** 1. Move the cursor to the desired function.

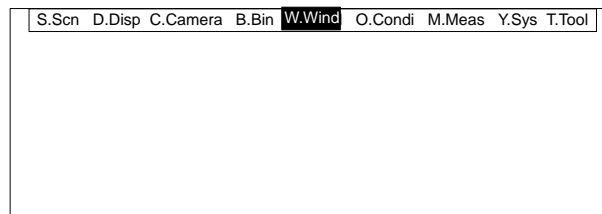

2. Press the Enter Key. The next menu in the hierarchy will then be displayed.

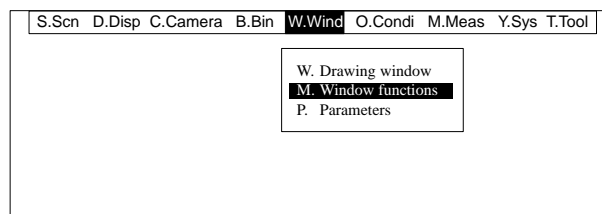

3. Move the cursor to the name of the desired menu and press the Enter Key. The menu will then be displayed. Repeat this step to access further menus.

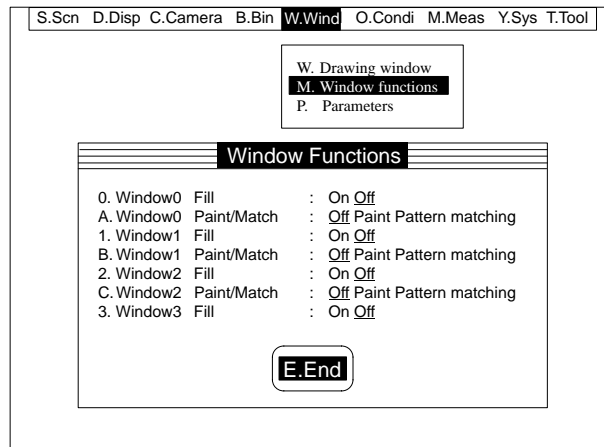

4. Press the Escape Key to return to the previous menu in the hierarchy. Repeat this step to return to the menu before that. This operation can be executed repeatedly until the basic menu is reached.

1-4-3 Setting Data

There are two types of screens for setting data: dialog boxes and toggle boxes. In a dialog box, make all of the desired settings and then select E. End to enter them all at once. In a toggle box, select one item from the list. At the time of shipping, the default values are set. Change the set values according to the application.

Setting Data in Dialog Boxes

- 1, 2, 3... 1. Open the dialog box in which the data is to be changed. The current settings will be underlined.

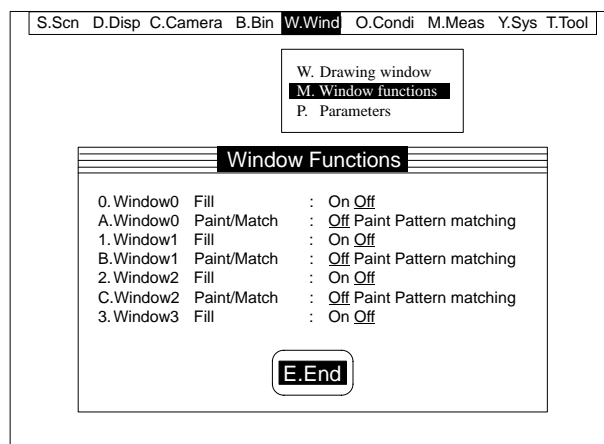

2. Move the cursor to the current setting that you wish to change.

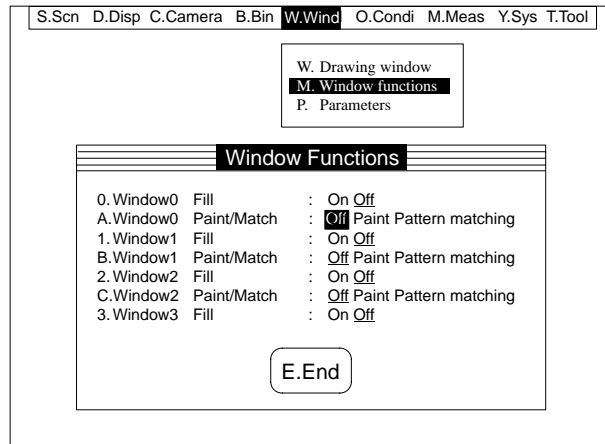

3. Move the cursor to the desired setting.

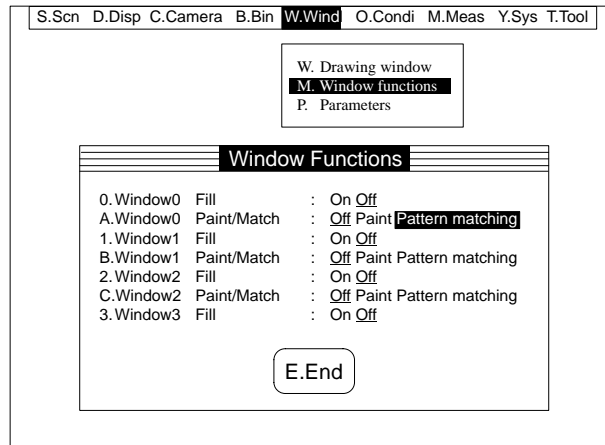

4. Move the cursor to E. End. The changed data will be underlined.

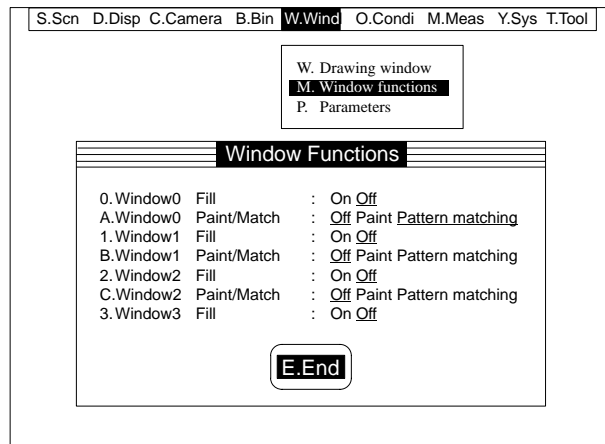

5. Press the Enter Key to set the data.

Setting Data in Toggle Boxes

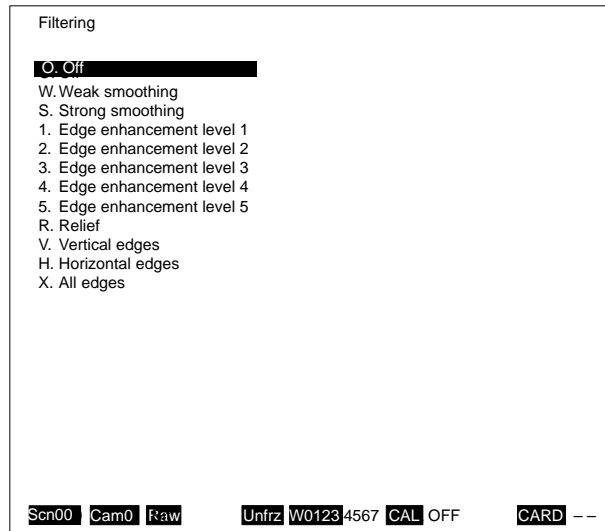

- 1, 2, 3... 1. Open the toggle box in which the data is to be changed. The cursor will be positioned at the current setting.

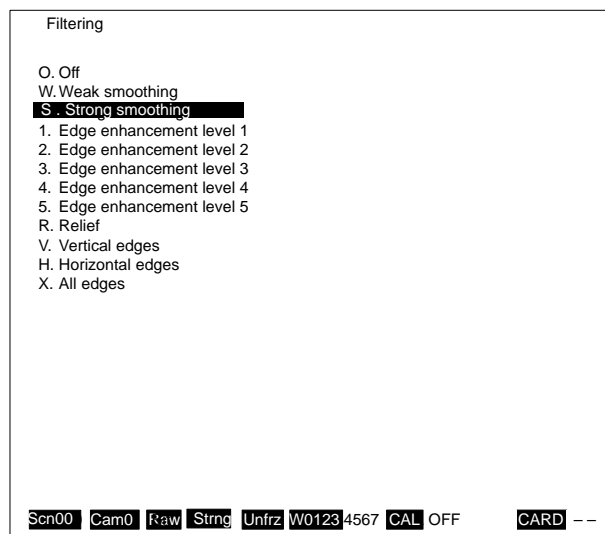

2. Move the cursor to the desired setting and then press the Enter Key. The data at the new cursor position will be set.

1-4-4 Inputting Numbers

The methods for inputting numbers required for operations such as copying scenes and setting determination criteria are explained here. There are two ways to input numbers. The first is to change numbers incrementally or decrementally, and the second is to input numbers directly.

Changing Numbers Incrementally or Decrementally

- 1, 2, 3... 1. Move the cursor to the item for which the number is to be changed.

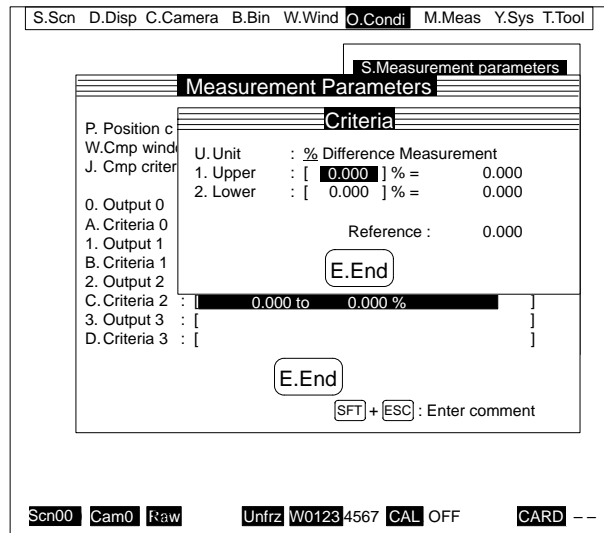

2. Change the number by means of the Right and Left Keys. When the Right Key is entered, the smallest unit will be incremented by one. When the Left Key is entered, the smallest unit will be decremented by one. To increment or decrement the number ten times faster, press the Shift Key along with the Right Key or Left Key respectively.

Inputting Numbers Directly

The method shown here applies when using the console, and not when menus are operated through RS-232C. The method for inputting numbers directly by means of RS-232C is shown on the following page.

- 1, 2, 3... 1. To go into the numeric input mode, move the cursor to the item for which the number is to be entered, and press the Enter Key.
2. Move the cursor to the digit that is to be changed.

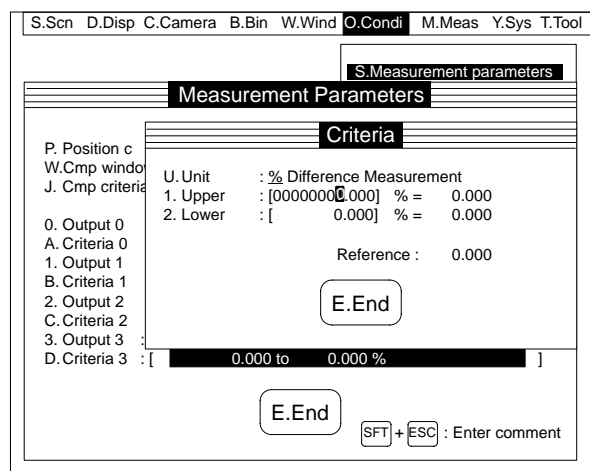

- Press the Up Key or the Down Key to change the number. Pressing the Up Key will increment the number by one. Pressing the Down Key will decrement the number by one. If more than one digit needs to be changed, then repeat steps 2 and 3 for each additional digit.

Note To enter a minus sign, move the cursor to the leftmost digit and press the Up and Down Keys.

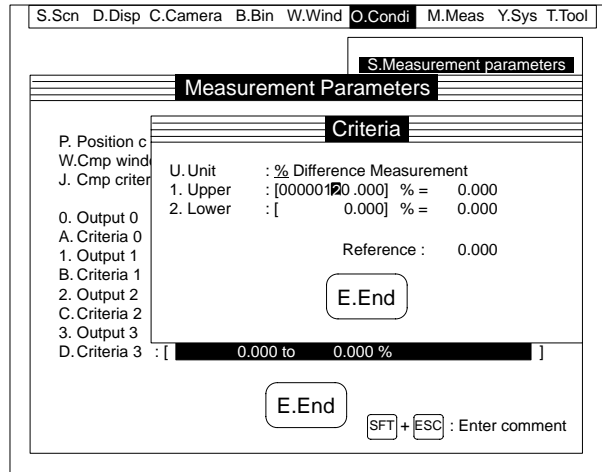

- Press the Enter Key. The number will then be changed.

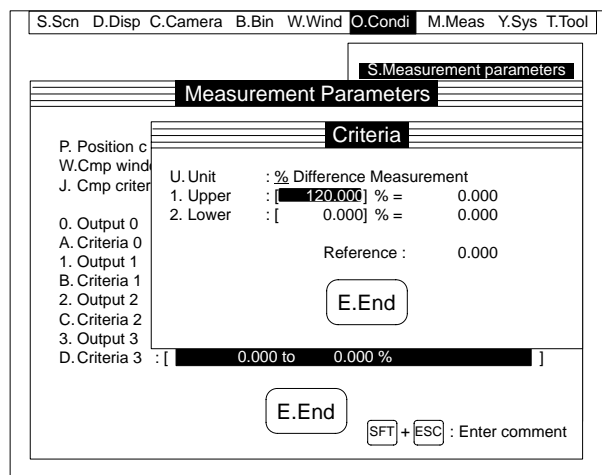

Note To clear a number (i.e., set it to 0), press the Shift Key and the Enter Key simultaneously while in the numeric input mode.

Using RS-232C

Follow the procedure shown here to input numbers using RS-232C.

- 1, 2, 3... 1. To go into the numeric input mode, move the cursor to the item for which the number is to be entered, and press the Enter Key.

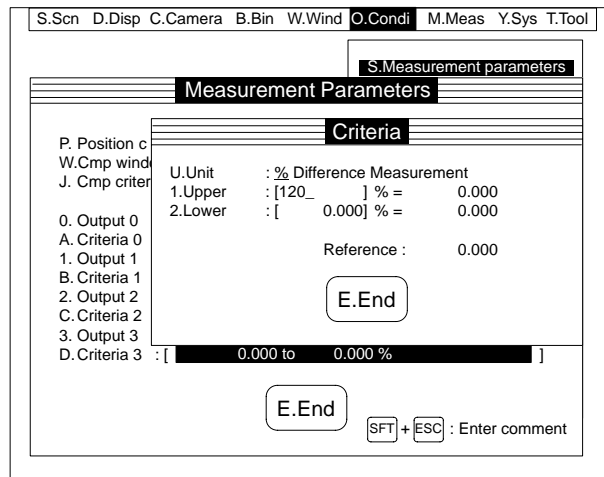

2. Enter the number that is to be set, including the decimal point. The number will not be valid if too many digits or more than three decimal places are entered.

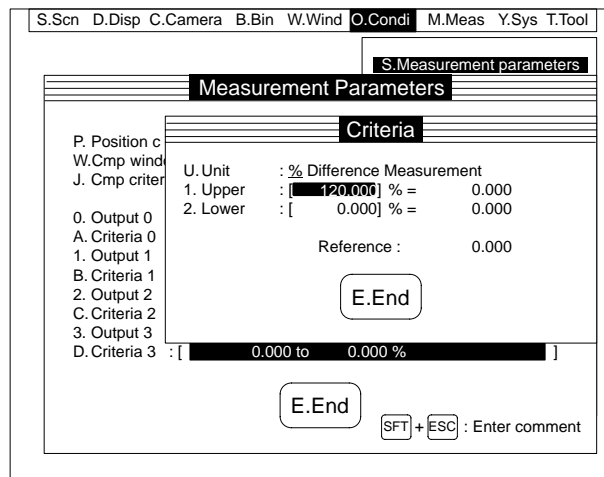

3. Press the Enter Key. The number will then be changed.

1-4-5 Inputting Characters

The method for inputting characters for scene comments, filenames, and so on, is explained here. Characters can be input by selecting them from the character list displayed on the screen. At the time of shipping, no characters are set. The characters that can be input are as follows:

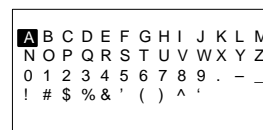

In addition to these characters, the following functions are available.

Display	Operation
DEL	Deletes the character at the cursor position.
BS	Deletes the character just to the left of the cursor position.
INS	Toggles between insert and overwrite mode. (The default is overwrite mode.)
←	Moves the cursor to the left.
→	Moves the cursor to the right.
END	Ends the character input operation.

- 1, 2, 3...
- To go into the character input mode, move the cursor to the item for which the character is to be entered, and press the Enter Key. The characters that can be input will be displayed on the screen.

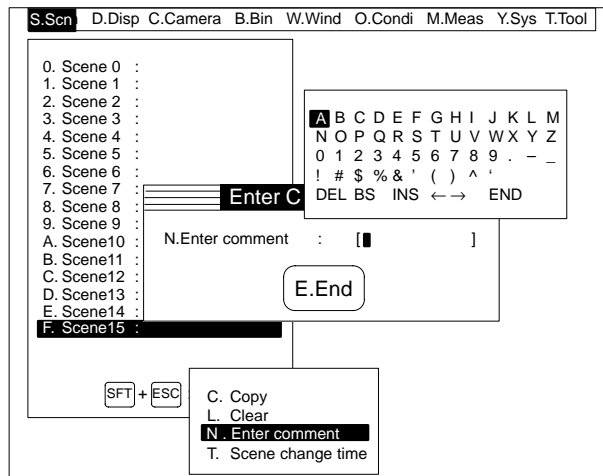

- Move the cursor to the character that is to be entered.

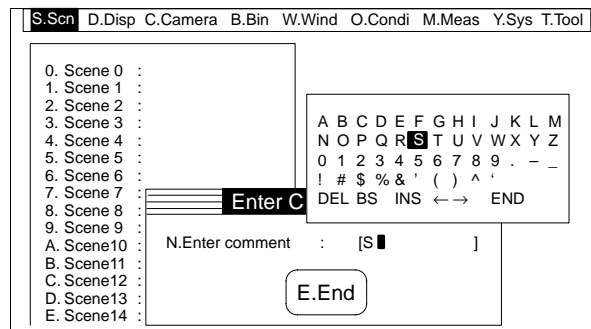

3. Press the Enter Key. The character will then be entered. If more than one character needs to be entered, then repeat steps 2 and 3 for each additional character.
4. When all the desired characters have been entered, either press the Escape Key or move the cursor to END and press the Enter Key. The input characters will be set and the character input mode will be exited.

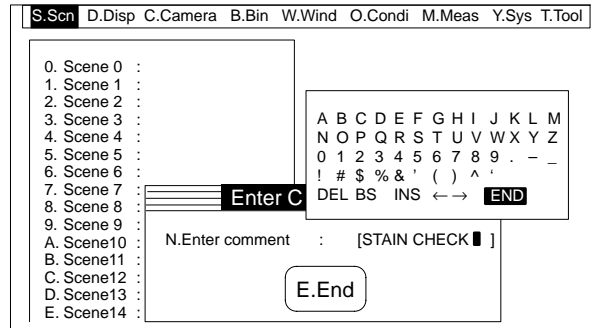

1-4-6 Editing Input Characters

To edit characters that have been input, go into character input mode and follow the procedures shown below.

Deleting All Characters

In order to delete all of the characters, press the Shift Key and the Enter Key simultaneously.

Deleting Single Characters

In order to delete a single character, follow the procedure shown below.

- 1, 2, 3...** 1. Move the cursor to the character that is to be deleted.

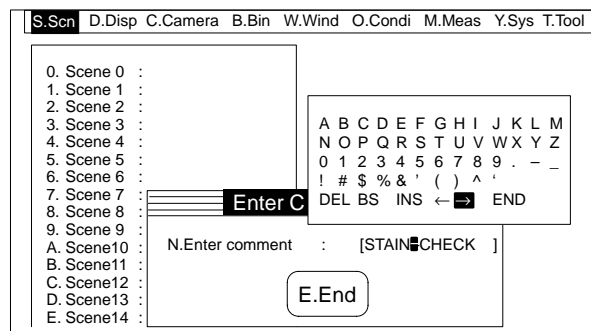

2. Move the cursor to DEL.

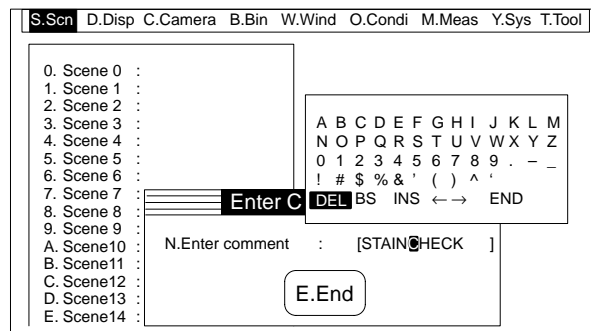

3. Press the Enter Key. The character at the cursor position will then be deleted. To continue deleting characters one by one, repeat steps 1 through 3.

Inserting Single Characters In order to insert a single character, follow the procedure shown below.

- 1, 2, 3... 1. Move the cursor to INS.

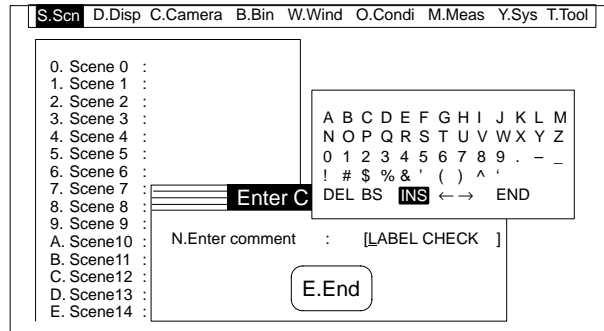

2. Press the Enter Key to go into insert mode. The cursor will become an underline.
3. Move the underline to the position where the character is to be inserted.
4. Enter the character that is to be inserted. To continue inserting characters one by one, repeat steps 3 and 4.
5. Move the cursor to INS.
6. Press the Enter Key. The mode will change back from insert mode to over-write mode, and the underline will be changed back to a cursor.

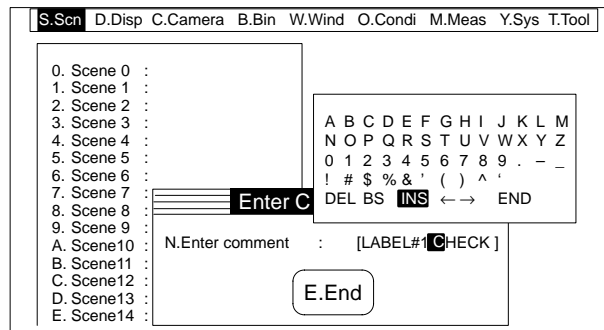

1-4-7 Displaying Help Messages

Help messages explaining menu functions can be displayed during menu operations. They are useful when menu functions or applications are not fully understood, and they can be displayed for any menus except for measurement screens or saving reference image screens.

- 1, 2, 3...** 1. Press the Help Key. The help message related to the menu currently being displayed will appear.

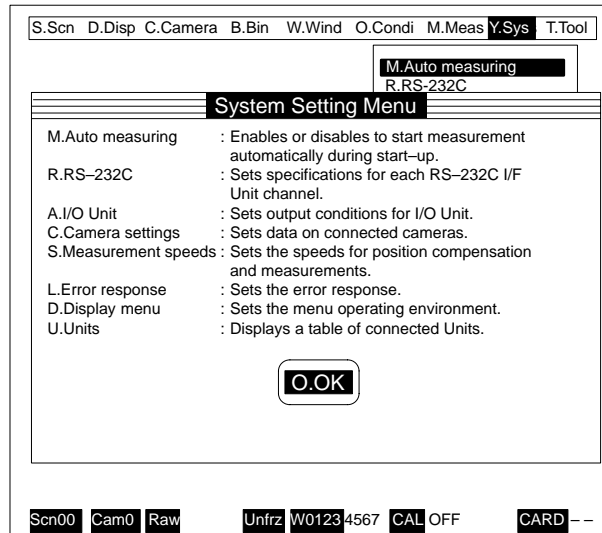

2. To return to the menu that was being displayed just before the help message was brought up, press either the Enter Key or the Escape Key.

1-4-8 Displaying the F200 Version

- 1, 2, 3...** 1. While the Basic Screen is being displayed, press the Shift Key and the Escape Key simultaneously. The version will then be displayed.

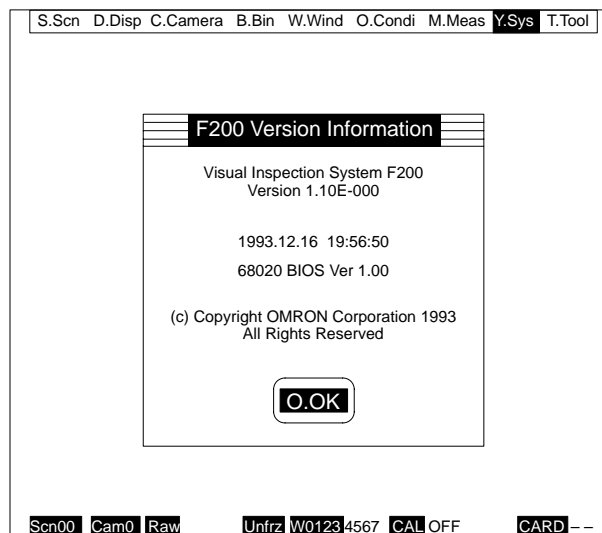

2. To return to the Basic Screen, press either the Enter Key or the Escape Key.

1-4-9 Starting and Quitting

Starting

Before starting up the F200, check to be sure that the basic configuration is completely connected and that the power supply and ground lines are wired. Then follow the procedure outlined below.

- 1, 2, 3... 1. Turn on the power supply switch for the video monitor.
2. Turn on the power supply switch for the Power Supply Unit. The Initial Screen will then be displayed at the video monitor.

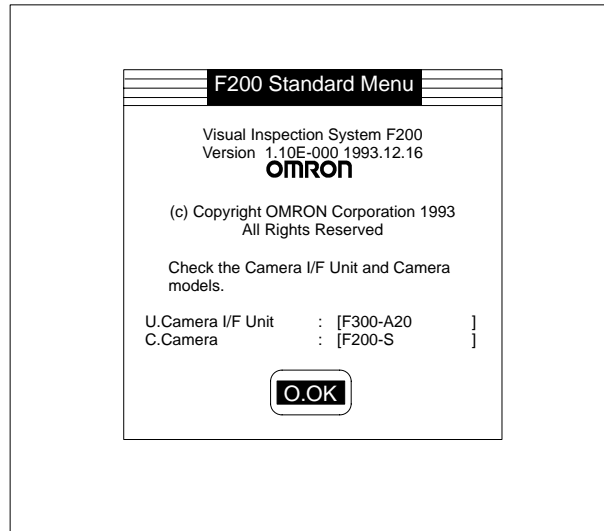

Checking the Initial Screen

Check the Initial Screen to be sure that the correct Camera I/F Unit and camera are shown. Also check to be sure that the Camera I/F Unit and camera shown in the Initial Screen are the same as those that are actually connected. If they are the same, then select O. OK. The Basic Screen will then be displayed.



If the Camera I/F Unit and camera shown in the Initial Screen are not the same as those that are actually connected, then the correct images cannot be taken and the measurements will be wrong. The Camera I/F Unit and camera settings must be corrected before proceeding further. After the settings have been corrected, select O. OK to display the Basic Screen.

Setting Camera I/F Units

The currently connected Camera I/F Unit is recognized automatically and the model is displayed. When any Camera I/F Unit other than a Shutter Simultaneously Camera I/F Unit is mounted, no particular operation is required. To set the Camera I/F Unit, follow the procedure outlined below.

- 1, 2, 3...**
1. Select U. Camera I/F Unit. The model numbers of the Shutter Simultaneously Camera I/F Unit will be displayed.
 2. Set the number of the Camera I/F Unit that is mounted. The number will then appear on the Initial Screen. Check to be sure that the model number that is displayed matches the model that is actually mounted.

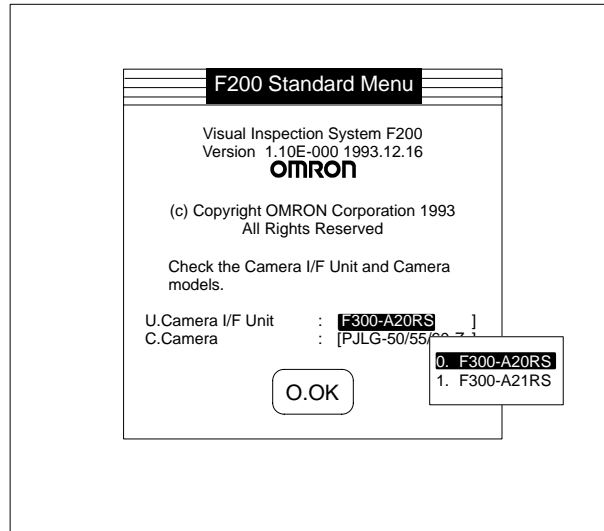

Setting Cameras

The cameras that can be mounted to each type of Camera I/F Unit are shown in the table below. Make the selection from among these.

Camera I/F Units	Cameras
F300-A20 Normal Camera I/F Unit	F200-S, F300-S
F300-A20S Normal Simultaneously Camera I/F Unit	F300-S
F300-A20R Shutter Camera I/F Unit	PJLG-50/55/60-Z
F300-A20RS Shutter Simultaneously Camera I/F Unit	PJLG-50/55/60-Z
F300-A21RS Shutter Simultaneously Camera I/F Unit	PJLG-70-Z

Note Cameras other than those listed above may not operate properly. If you wish to use another type of camera, consult with your local OMRON sales office (listed at the back of this manual). The F300-A21RS Shutter Simultaneously Camera I/F Unit and the PJLG-50/60/70-Z Shutter Cameras are not available at this time.

- 1, 2, 3...**
1. Select C. Camera. The model numbers of the cameras that can be connected will be displayed.

2. Set the number of the camera that is connected. The number will then appear on the Initial Screen. Check to be sure that the model number that is displayed matches the model that is actually mounted.

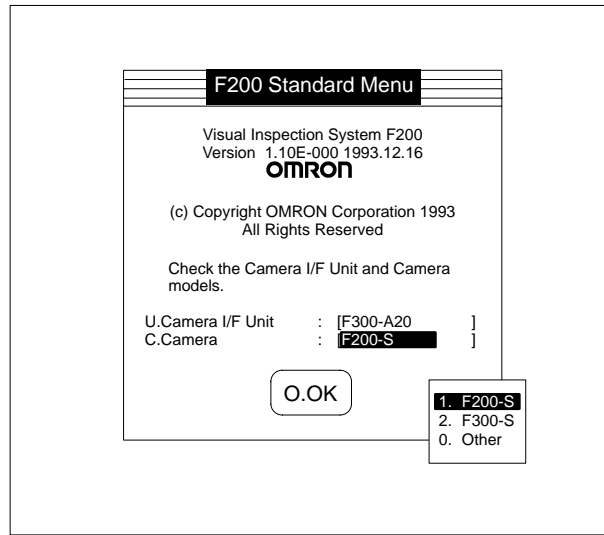

Quitting

Before quitting, check to be sure that none of the following conditions are in effect:

- Menu operations being carried out.
- "Working" displayed in the lower right hand corner of the menu. (See 1-4-1 Basic Menu Operations.)
- The MMI Unit's orange Memory Card Access LED indicator lit.

In none of these conditions is in effect, then carry out the following procedure.

- 1, 2, 3... 1. Turn OFF the power supply switch for the F200.
2. Turn OFF the power supply switch for the video monitor. Even after the power supply is turned off for the F200, all of the data set for each menu will be retained.

SECTION 2

Installation

This section provides the information necessary for installing an F200 Visual Inspection System. It includes system configuration, mounting instructions, wiring diagrams, and external dimensions. Specifications are provided in *Appendix A Specifications*.

2-1	System Configuration	26
2-2	System Setup	28
2-2-1	Mounting Units	28
2-2-2	Connecting the Console	29
2-2-3	Connecting the Video Monitor	31
2-2-4	Connecting Cameras	32
2-2-5	Attaching the Cover	34
2-3	Power and Ground Wiring	35
2-3-1	Power Wiring	36
2-3-2	Ground Wiring	36
2-4	Installation Environment	37
2-4-1	Location	37
2-4-2	Installation	37
2-4-3	Precautions	38
2-5	Connecting Peripheral Devices	39
2-5-1	Wiring an External Power Supply	39
2-5-2	Wiring External Outputs	39
2-5-3	Connecting Strobe I/F Units	40
2-5-4	Connecting RS-232C I/F Units	41
2-5-5	Connecting Terminal Block Units	43
2-5-6	Connecting Parallel I/O Units	43
2-6	External Dimensions	45
2-6-1	Units	45
2-6-2	Console	47
2-6-3	Video Monitor	47
2-6-4	Normal Cameras	48

2-1 System Configuration

Check to be sure that all of the Units required for setting up the basic system configuration are on hand. If peripheral devices are to be used, then make sure that all of the devices, connecting cable, and so on are ready to be connected.

Basic System Configuration

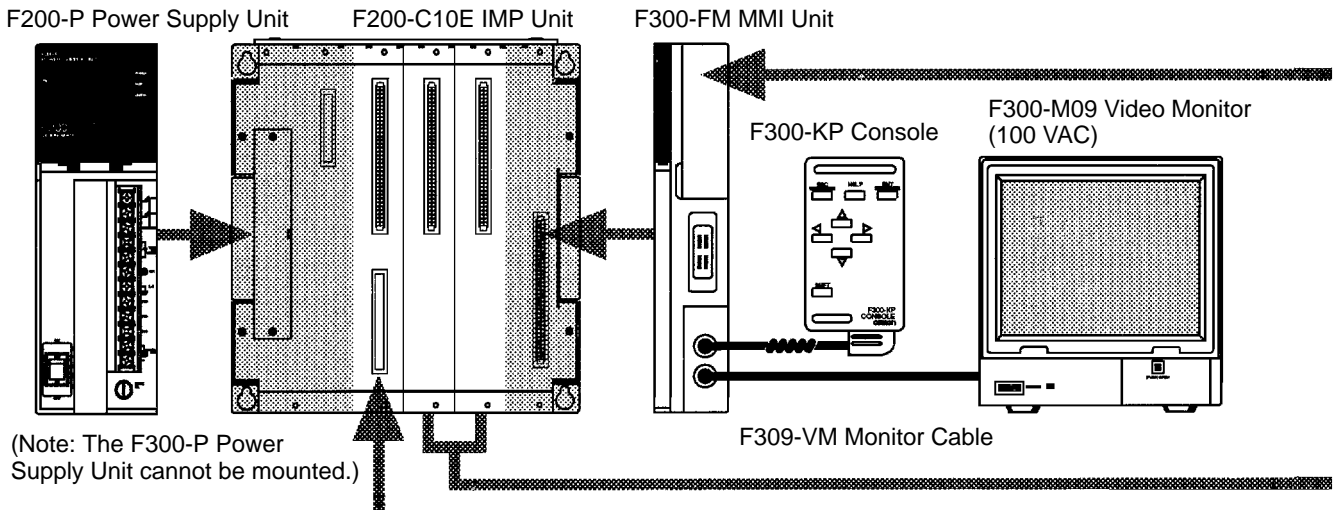

Camera I/F Units (Use one.)

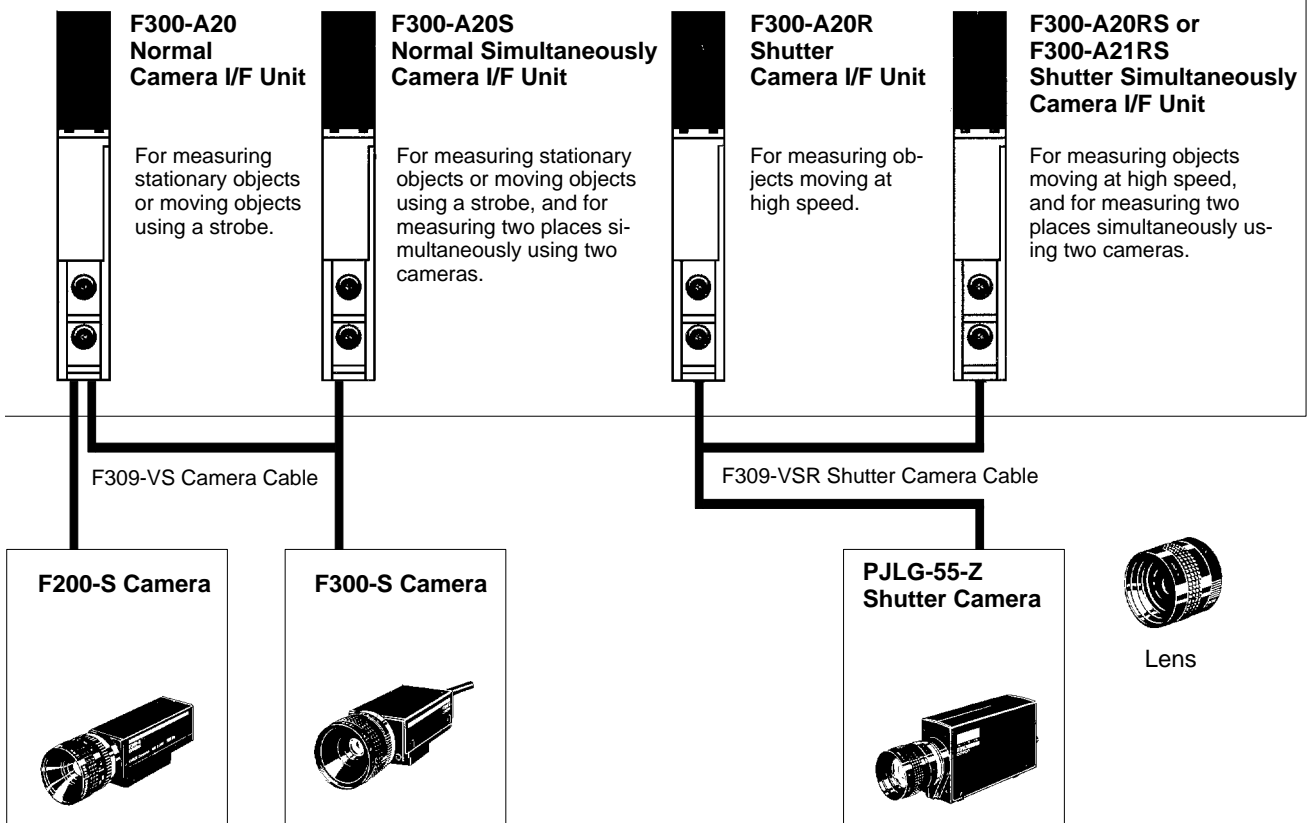

Note: Up to two cameras of the same type can be used (but different models cannot be used together).

Peripheral Devices

F300-N256/N512 Memory Card

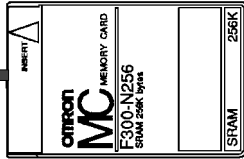

Used for storing scene data, system data, and output data (e.g., measurement values, judgement results, etc.).

I/F Units (Use the one that matches the peripheral devices connected.)



F300-E RS-232C I/F Unit
For saving scene and system data and carrying out menu operations via RS-232C interface.



F300-E Terminal Block Unit
For inputting measurement instructions and outputting judgement results via a terminal block.



F300-DC Parallel I/O Unit
For inputting measurement instructions and outputting measurement values and judgement results via parallel I/O.



F300-FS Strobe I/F Unit
For flashing the strobe while taking images.



F300-G Dummy Unit
For inserting into empty slots to protect and strengthen connectors.

F309-VR RS-232C Cable

IBM PC/AT or Compatible

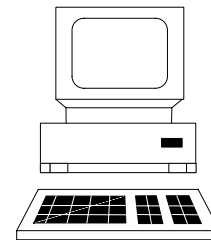

C200H or CQM1 Programmable Controller

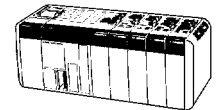
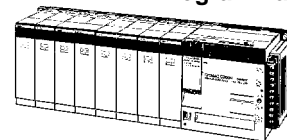

Synchronization Sensor

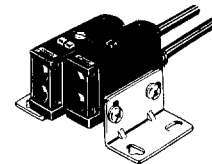

Strobe Device

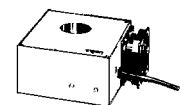

F309-VFS Strobe Cable

Note: The F300-L100E OVL Unit cannot be mounted.

2-2 System Setup

Follow the instructions outlined below to set up the F200 Visual Inspection System.

2-2-1 Mounting Units

The Units must be mounted in the positions shown in the following illustration. Be sure to mount all Units in their correct positions.

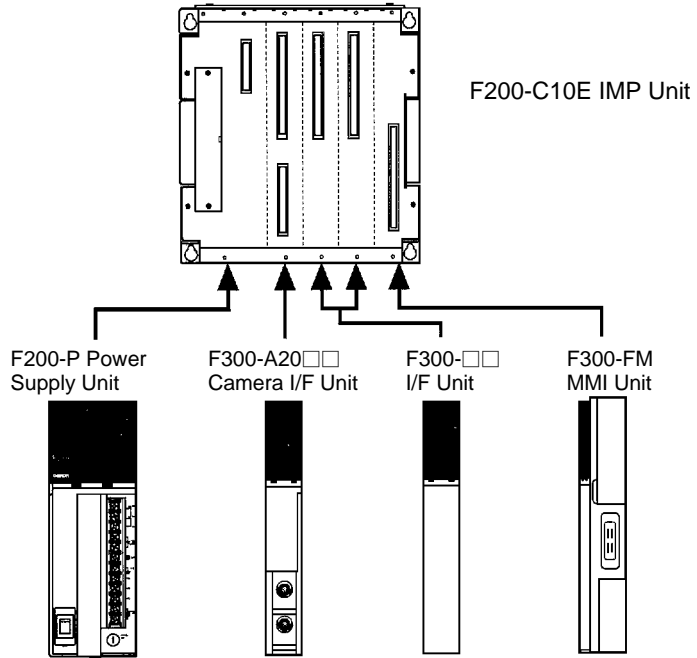

Procedure

- 1, 2, 3... 1. Line up the catches at the top of the Unit with the notches at the top of the IMP Unit, and carefully match the connectors.

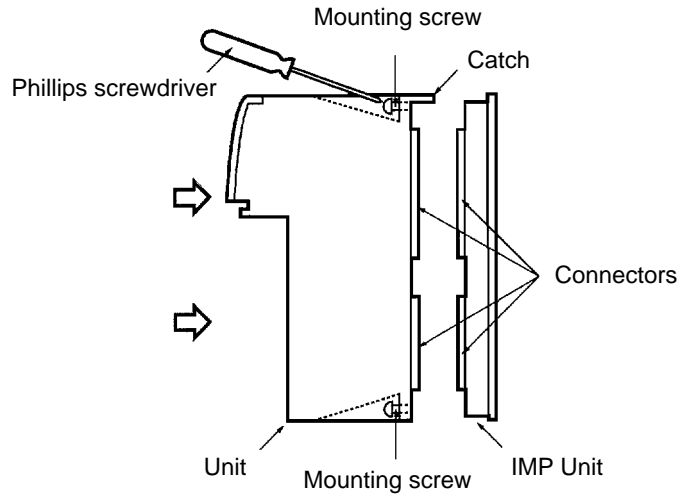

2. Press the Unit horizontally into the IMP Unit.
 3. With a Phillips screwdriver, tighten the mounting screws.

Caution Be sure to turn off the power supply before mounting Units. Replacing or adding a Unit while the power is turned on may result in damage to the Unit.

2-2-2 Connecting the Console

The console connector is located under the MMI Unit connector cover.

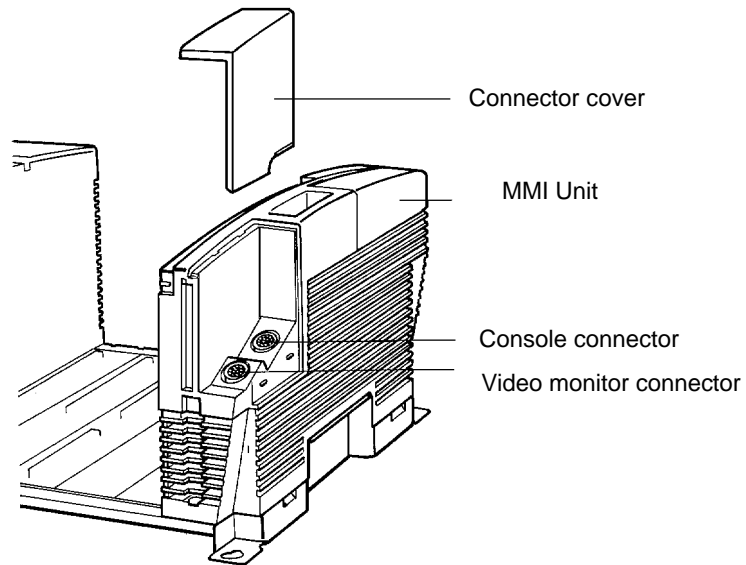

Inserting the Connector

- 1, 2, 3...**
1. Turn off the power supply switch for the Power Supply Unit.
 2. Holding the rubber part of the connector, line the connector up with the receptor.

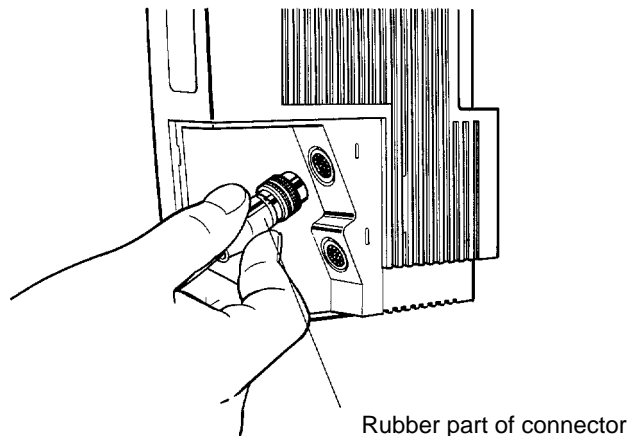

3. Push the connector in straight ahead until it locks in place.

Removing the Connector

- 1, 2, 3...
1. Unlock the connector by pulling lightly on the connector ring, a shown in the illustration below. Do not pull on the rubber part of the connector or on the cable.

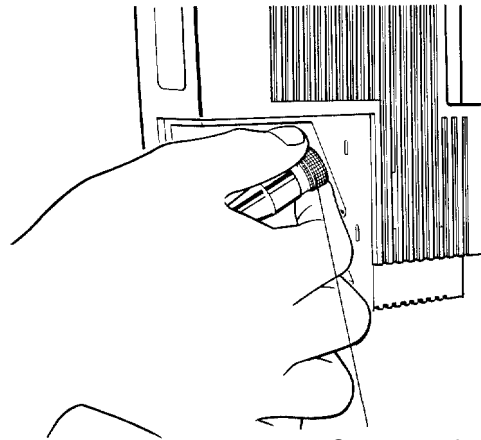

Connector ring

2. Still holding onto the connector ring, pull the connector straight out.

Housing the Console

When the console is not in use, it can be housed in the MMI Unit as shown in the illustration below.

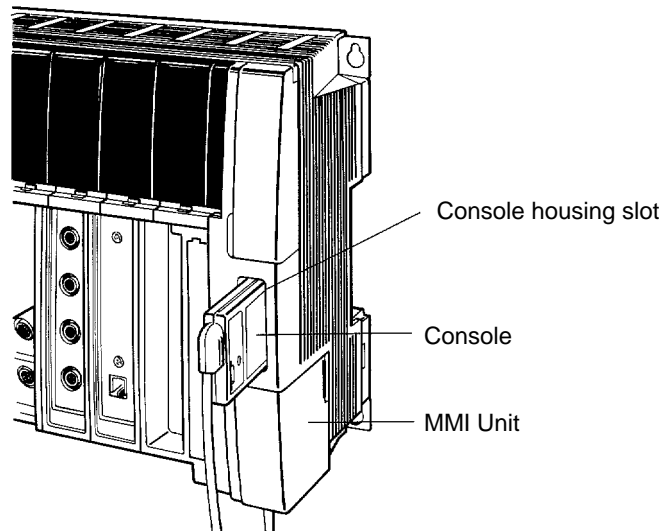

2-2-3 Connecting the Video Monitor

The video monitor connector is located under the MMI Unit connector cover. (See the illustration under 2-2-2 *Connecting the Console.*)

Connecting at the Rear of the Video Monitor

- 1, 2, 3... 1. Turn off the power supply switch for the video monitor.
2. Connect the BNC connector of the monitor cable to the video input terminal at the back of the video monitor.
3. Set the termination resistance switch to 75 Ω .

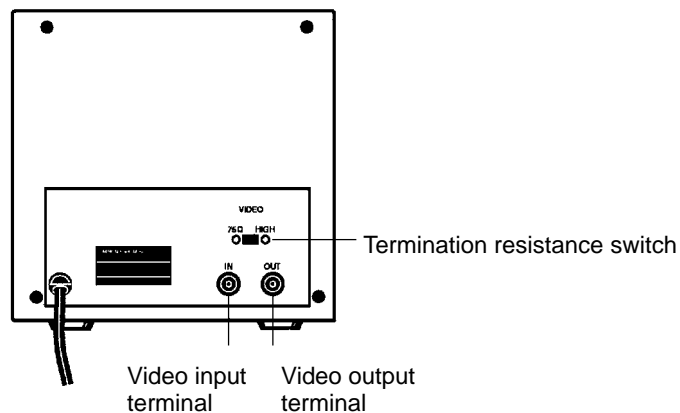

Connecting at the MMI Unit

- 1, 2, 3... 1. Holding the rubber part of the video monitor connector, line the connector up with the receptor.

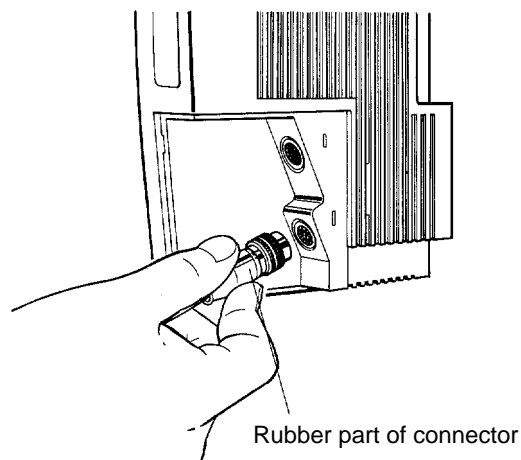

2. Push the connector in straight ahead until it locks in place.

Removing the Connector

- 1, 2, 3...** 1. Unlock the connector by pulling lightly on the connector ring, a shown in the illustration below. Do not pull on the rubber part of the connector or on the cable.

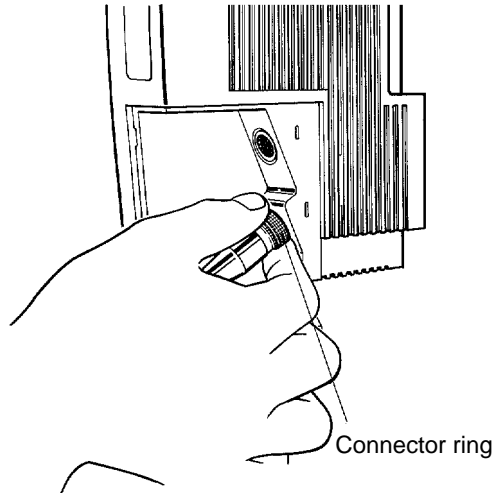

2. Still holding onto the connector ring, pull the connector straight out.

2-2-4 Connecting Cameras

A maximum of two cameras can be connected to a Camera I/F Unit.

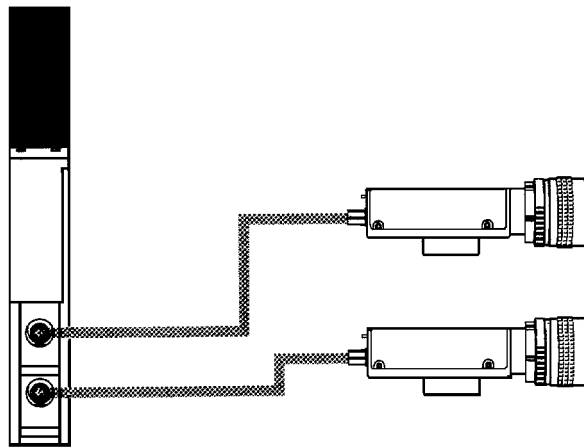

Connecting at the Camera

To make the connection at the cameras itself, follow one of the procedures outlined below, depending on whether a normal or shutter camera is to be used.

Standard Cameras

- 1, 2, 3...** 1. If an F300-S Camera is to be used, then check to be sure that the normal camera switch settings are as follows:

AGC switch	OFF
SHT switch	OFF

2. Connect the “normal camera” cable socket connector to the “normal camera” connector.

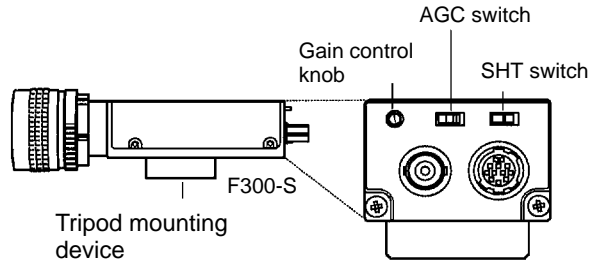

Shutter Cameras

- 1, 2, 3... 1. Check to be sure that the shutter camera switch settings are as follows:

Synchronization method	External synchronization
Scanning method	Non-interlace

2. Connect the shutter camera cable connector to the camera connector. For detailed instructions, refer to the camera operation manual.

Connecting at the Camera I/F Unit

- 1, 2, 3... 1. Turn off the power supply switch for the Power Supply Unit.
2. Holding the rubber part of the camera cable connector, line the connector up with the receptor as shown in the following illustration.

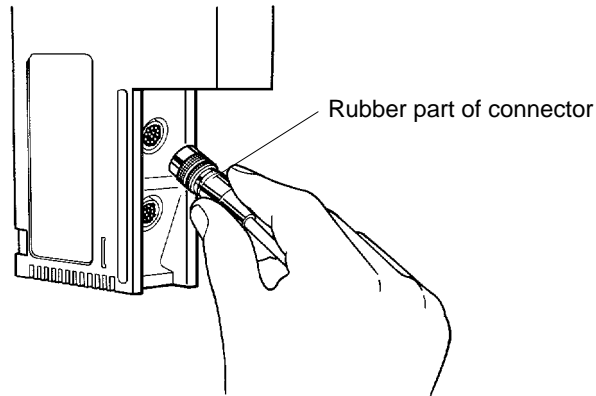

3. Push the connector in until it locks in place.

Removing the Connector

- 1, 2, 3... 1. Unlock the connector by pulling lightly on the connector ring, a shown in the illustration below. Do not pull on the rubber part of the connector or on the cable.

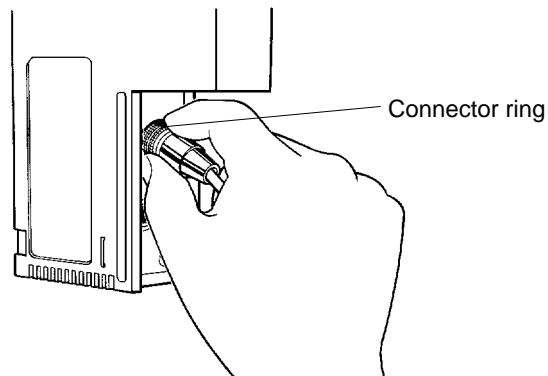

2. Still holding onto the connector ring, pull the connector straight out.

2-2-5 Attaching the Cover

It is recommended that the cover be attached in order to protect connecting cables to Units and peripheral devices, and to guard against malfunctioning.

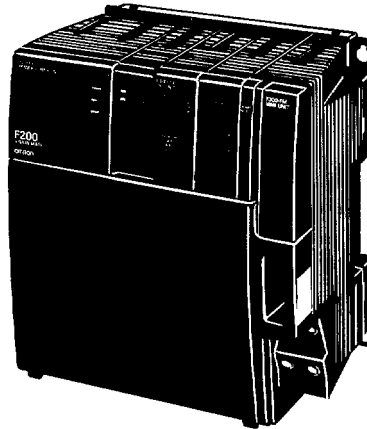

Procedure

- 1, 2, 3...
 1. Holding the bottom of the cover, insert the catches on the top of the cover into the notches on the front surface of the Unit.
 2. Lightly push down the bottom of the cover, lining it up with the Unit.

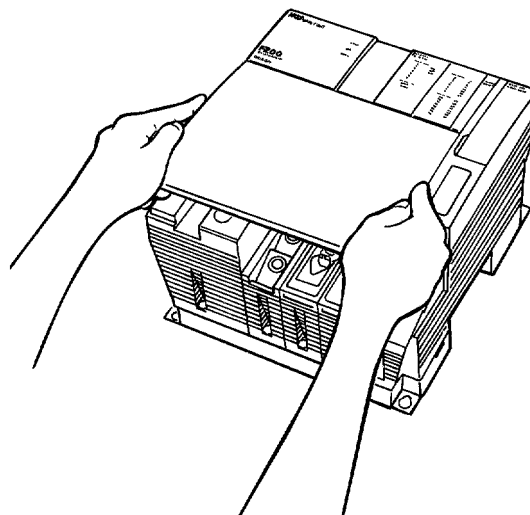

3. Press the cover into place until it locks.

Caution Do not force the cover into place, and do not place any heavy objects on top of the cover.

Removing the Cover

- 1, 2, 3... 1. Unlock the cover by lightly lifting up from the bottom.

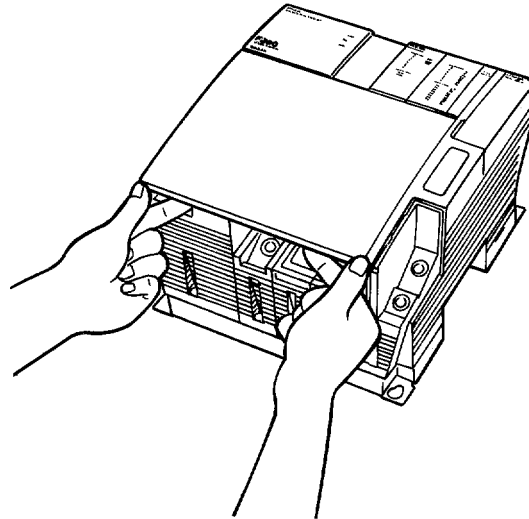

2. Continue lifting the cover and remove the catches at the top of the cover from the notches in the Unit.

2-3 Power and Ground Wiring

Connect power cables and ground cables to the F200-P Power Supply Unit terminal block. The terminal block uses M4 screw connectors. Use the crimped connectors shown in the table below.

Crimped Connectors



Recommended Parts

An applicable cable from 1.04 to 2.63 mm² should be used.

2-3-1 Power Wiring

In order to avoid voltage drops, use power cables of at least 2 mm². To avoid interference from inductive noise, use twisted-pair cable. Wire the F200 power supply separately from other devices. In particular, wire it separately from any inductive loads.

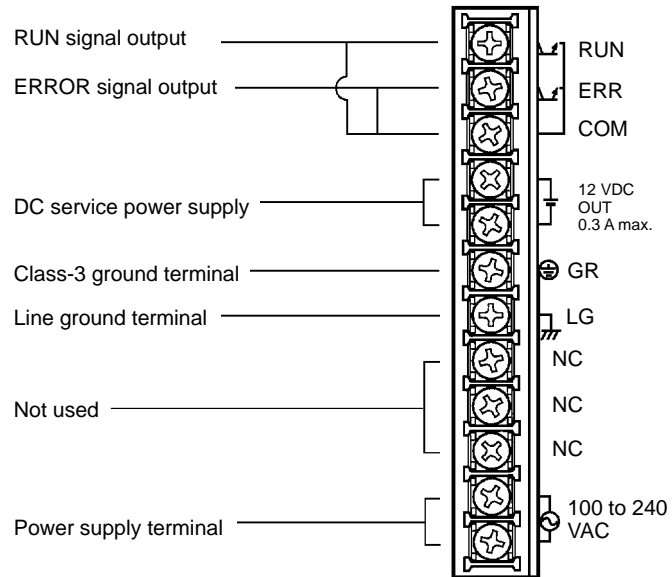

2-3-2 Ground Wiring

In order to prevent electrical shock, use a class-3 ground (with a maximum ground resistance of 100 Ω). Use a ground wire of at least 2 mm².

If interference results from excessive noise, then short-circuit the GR and LG with the accessory short bar and use a class-3 ground.

Do not share the ground wire with any other devices or ground it to a metal frame. Doing so may result in damage to the equipment. Be sure to use a dedicated ground wire for the F200.

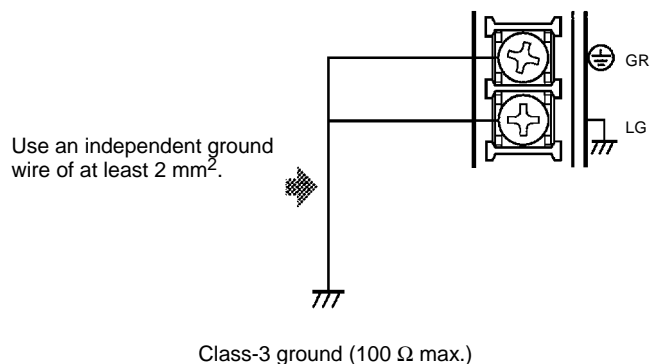

2-4 Installation Environment

The F200 System is highly reliable and resistant to environmental factors. The following guidelines, however, must be followed to ensure reliability and to get full use of the System.

2-4-1 Location

Do not install an F200 System in locations subject the following conditions:

- Temperatures outside 0°C to 50°C
- Condensation due to rapid temperature fluctuations
- Relative humidity outside 35% to 85% RH
- Corrosive or flammable gas
- High concentrations of dust, salt, or iron particles
- Direct vibration or shock
- Direct sunlight
- Water, oil, or chemicals fumes or spray

2-4-2 Installation

Consider environmental factors and ease of operation and maintenance when installing the F200 System in a control box.

Temperature Considerations

The operational temperature range of the F200 System is 0°C to 50°C. Take the following measures to maintain the F200 System in this range.

- Maintain a minimum of 50-mm clearance above and below the F200 System to improve air circulation.
- Do not install the F200 System immediately above strong heat sources, such as heaters, transformers, or large-capacity resistors.
- Provide a forced-air fan or air conditioning if the ambient temperature exceeds 50°C.

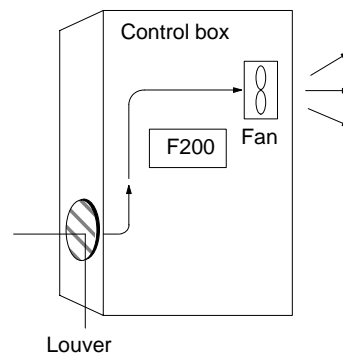

Operation and Maintenance Considerations

Keep the F200 System away from high-voltage equipment and motors to improve safety during operation and maintenance. The F200 System is easiest to work with if installed between 1.0 and 1.6 meters above the floor.

Noise Considerations

Do not install the F200 System in a cabinet containing high-voltage equipment or within 200 mm of power lines. Fully ground the mounting plate.

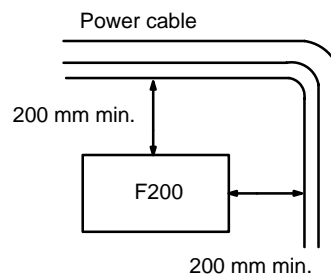

Dimensions

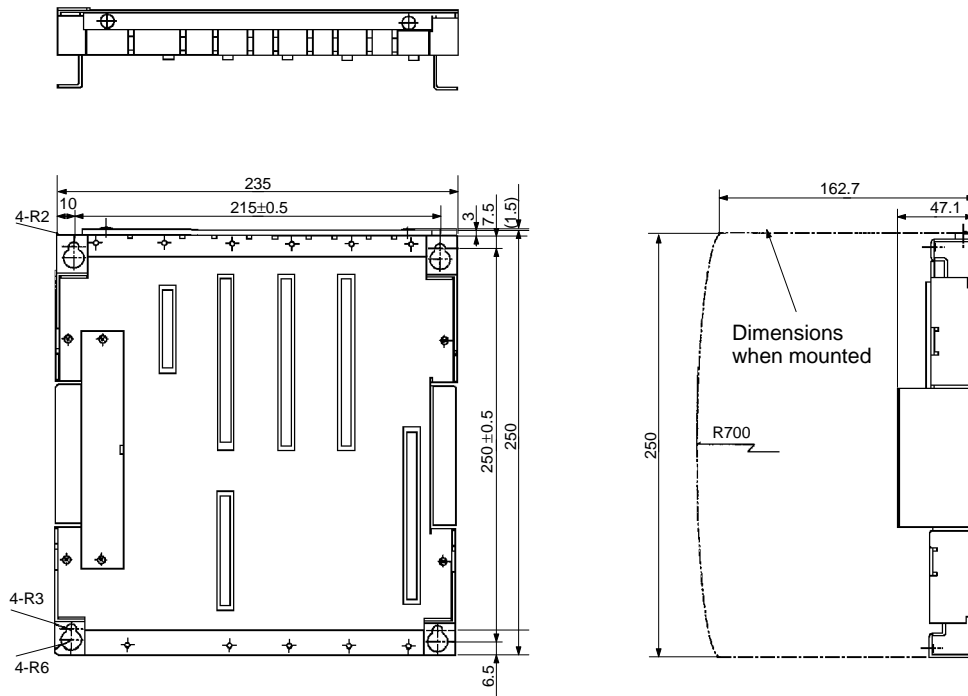

2-4-3 Precautions

Direction of Installation

Install the Unit vertically with the vents at the top and bottom to improve air circulation and heat dissipation. Do not install as shown in the right portion of the diagram below.

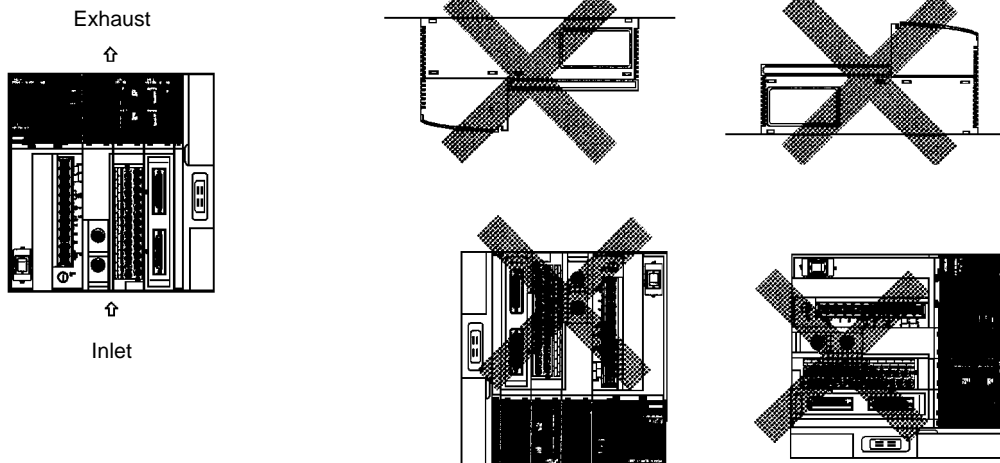

Clearance

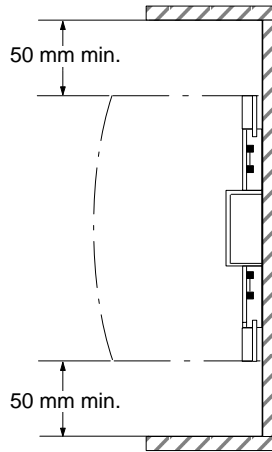

Maintain at least 50 mm clearance above and below the F200 System to improve air circulation.

2-5 Connecting Peripheral Devices

Using M4 self-rising screws as the terminal screws, connect the Power Supply Unit wiring. Use the crimped connectors shown below.

Crimped Connectors



Recommended Parts

An applicable cable from 1.04 to 2.63 mm² should be used.

2-5-1 Wiring an External Power Supply

The Power Supply Unit has a 12-VDC service power supply. Use it for the Terminal Block Unit and Parallel I/O Unit interface, and also as the power supply for external devices such as timing input sensors.

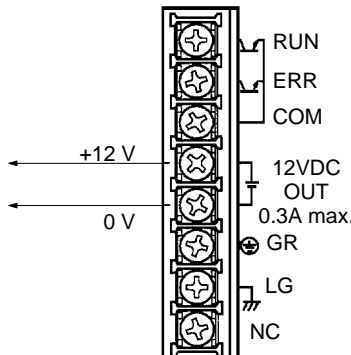

Output voltage: 12 VDC \pm 5%
Output current: 0.3 A max.

2-5-2 Wiring External Outputs

The Power Supply Unit can output RUN and ERR signals. Wire them as shown below. (For information on detecting and outputting errors that occur at a measurement screen, refer to 4-8-6 *Selecting the Error Output Method.*)

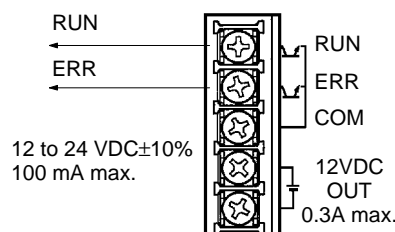

Signal	Remarks
RUN	ON during measurement processing. The RUN indicator on the front panel of the Power Supply Unit lights simultaneously with the signal output.
ERR	Can be turned ON when an error occurs at a measurement screen. The ERR indicator on the front panel of the Power Supply Unit lights simultaneously with the signal output.

2-5-3 Connecting Strobe I/F Units

Follow the procedure shown below to connect Strobe Units to an F300-FS Strobe I/F Unit.

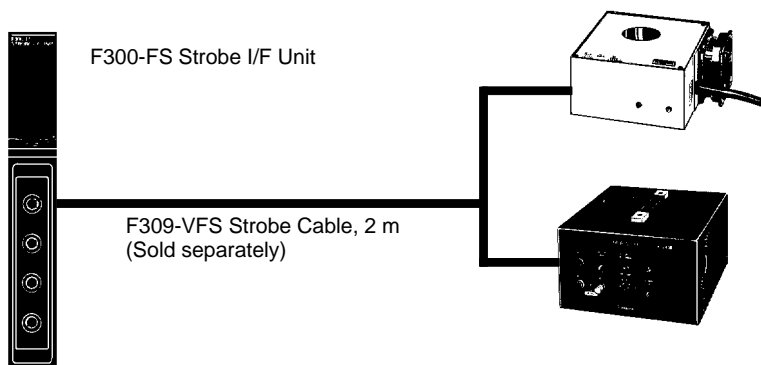

Procedure for Connecting Refer to 4-3-4 *Flashing the Strobe* for details on making the strobe flash.

- 1, 2, 3...**
1. Connect the strobe cable connector to the Strobe Unit.
 2. Holding the rubber part of the strobe cable connector, line up the connector with the receptor as shown in the illustration below.

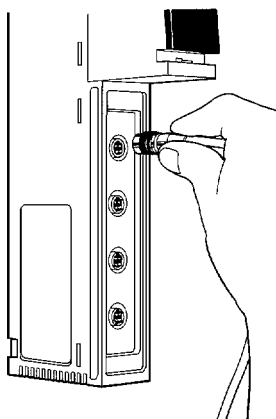

3. Push the connector in straight until it locks.

Procedure for Disconnecting

- 1, 2, 3... 1. Unlock the connector by pulling lightly on the connector ring, a shown in the illustration below. Do not pull on the rubber part of the connector or on the cable.

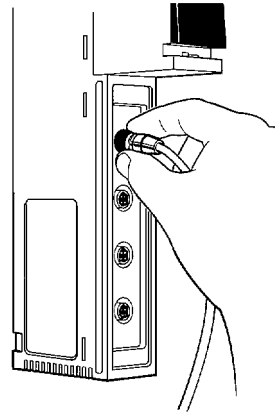

2. Still holding onto the connector ring, pull the connector straight out.

2-5-4 Connecting RS-232C I/F Units

Follow the procedure shown below to connect a device with an RS-232C interface to an RS-232C I/F Unit. (For instructions on setting RS-232C communications specifications, refer to *4-8-2 Setting RS-232C Communications Specifications*. For instructions on using the RS-232C I/F Unit as an input device, refer to *4-7-1 Inputting Commands at Measurement Screens*. For instructions on using the RS-232C I/F Unit as an output device for measurement results, refer to *4-7-2 Outputting Measurement Results*.)

Connectors

Use D-SUB25 pin connectors. The XM2A-2501 Connector (made by OMRON) is recommended. The pin numbers and names are as shown below.

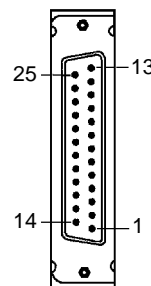

Pin no.	Symbol	Name
1	FG (GND)	Frame Ground
2	SD (TXD)	Send Data
3	RD (RXD)	Receive Data
4	RS (RTS)	Request to Send
5	CS (CTS)	Clear to Send
6	DR (DSR)	Data Settings Ready
7	SG (GND)	Signal Ground
8	CD (DCD)	Data Carrier Detected
20	ER (DTR)	Data Terminal Ready

Wiring

Standard

25-pin Cable Connection

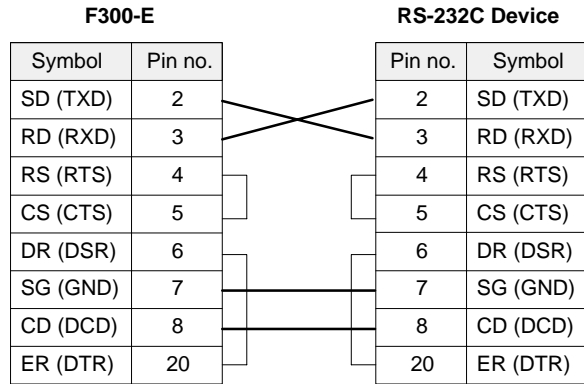

9-pin Cable Connection

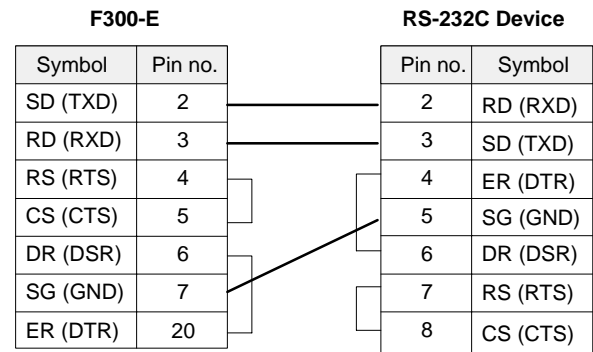

RS/CS Control

25-pin Cable Connection

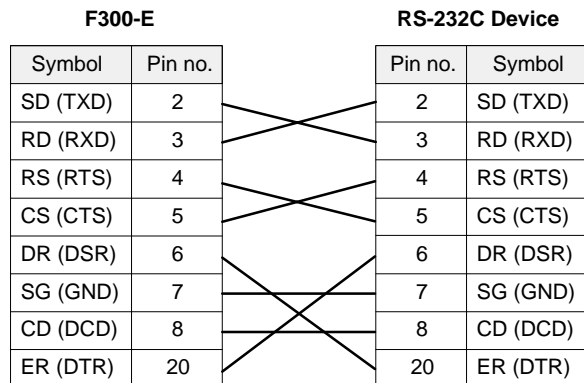

9-pin Cable Connection

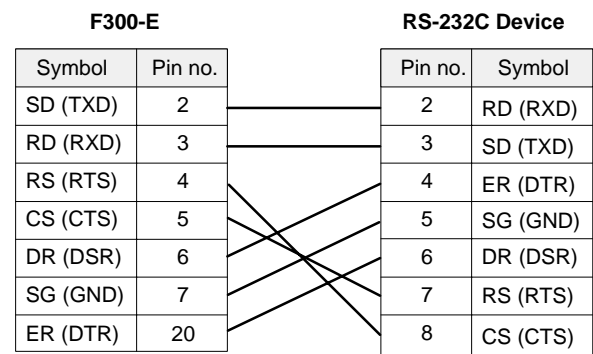

Connecting a Peripheral Device

- 1, 2, 3...**
1. Connect the RS-232C cable connector to the RS-232C connector of the peripheral device.
 2. Tighten the screws.
 3. Set the communications specifications.

Connecting the RS-232C I/F Unit

- 1, 2, 3...**
1. Connect the RS-232C cable connector to the connector of the RS-232C I/F Unit.
 2. Tighten the screws.
 3. Set the communications specifications.

Disconnecting the Cable

- 1, 2, 3...**
1. Loosen the screws.
 2. Holding the connector of the cable, pull the connector straight out.

2-5-5 Connecting Terminal Block Units

Connect Terminal Block Units to the Programmable Controller or personal computer. (For instructions on using a Terminal Block Unit as an input device, refer to 4-7-1 *Inputting Commands at Measurement Screens*. For instructions on using a Terminal Block Unit as an output device for measurement results, refer to 4-7-2 *Outputting Measurement Results*.)

Crimped Connectors

Use M4 self-rising screws as the terminal screws. Use the crimped connectors shown below.



Recommended Parts

An applicable cable from 1.04 to 2.63 mm² should be used.

Connectors

Terminal Block connectors are removable. They can be mounted or removed with the wiring still connected. The pin numbers and names are as shown below.

No.	Signal name	No.	Signal name	
2	STEP	1	COM IN (for input)	
4	DSA	3	RESET	
6	DI 1	Data input	5	DI 0
8	DI 3		7	DI 2
10	DI 5		9	DI 4
12	DI 7		11	DI 6
14	GATE		13	NC
16	DO 0	Data input	15	BUSY
18	DO 2		17	DO 1
20	DO 4		19	DO 3
22	DO 6		21	DO 5
24	AND		23	DO 7
26	OR	25	COM OUT (for output)	

2-5-6 Connecting Parallel I/O Units

Connect Parallel I/O Units to the Programmable Controller or personal computer. (For instructions on using a Parallel I/O Unit as an input device, refer to 4-7-1 *Inputting Commands at Measurement Screens*. For instructions on using a Terminal Block Unit as an output device for measurement results, refer to 4-7-2 *Outputting Measurement Results*.)

Connectors and Cable

The connectors and cable shown in the table below are recommended.

Item	Model number	Maker
Connectors used	57LE-40500-7300 (D34)	Daiichi Denshi Kougyo
Conforming connectors (1 set per Unit is included.)	57JE-B50H-L12	
Cable	UL2464 IFS-RVV-SB series	Fujikura Densen

Terminal Arrangement

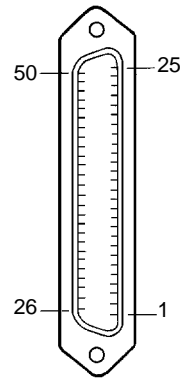

No.	Signal name	No.	Signal name
1	COM OUT (for output)	26	COM OUT (for output)
2	DO 31	27	DO 30
3	DO 29	28	DO 28
4	DO 27	29	DO 26
5	DO 25	30	DO 24
6	DO 23	31	DO 22
7	DO 21	32	DO 20
8	DO 19	33	DO 18
9	DO 17	34	DO 16
10	DO 15	35	DO 14
11	DO 13	36	DO 12
12	DO 11	37	DO 10
13	DO 09	38	DO 08
14	DO 07	39	DO 06
15	DO 05	40	DO 04
16	DO 03	41	DO 02
17	DO 01	42	DO 00
18	BUSY	43	GATE
19	NC	44	DI 7
20	DI 6	45	DI 5
21	DI 4	46	DI 3
22	DI 2	47	DI 1
23	DI 0	48	DSA
24	RESET	49	STEP
25	COM IN (for input)	50	COM IN (for input)

2-6 External Dimensions

2-6-1 Units

F200-C10E IMP Unit

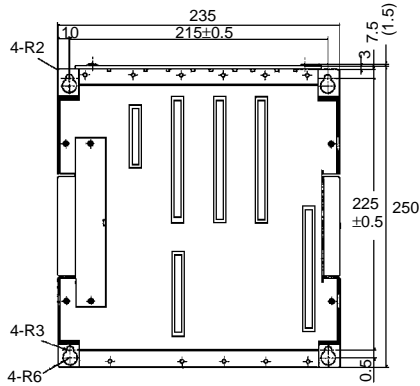

F200-P Power Supply Unit

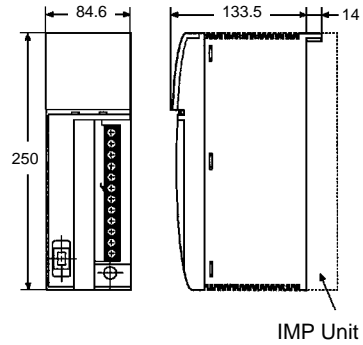

F300-FM MMI Unit

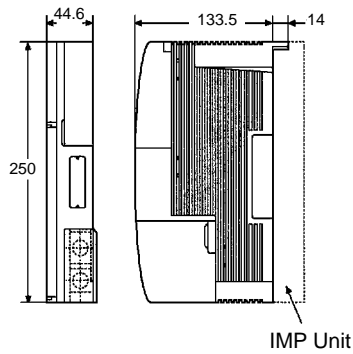

F300-A20 Normal Camera I/F Unit

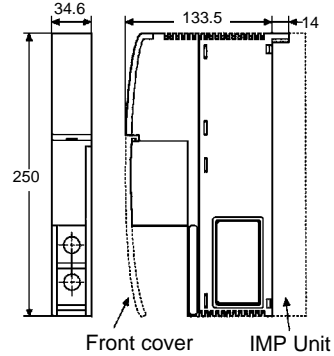

F300-A20S Normal Simultaneously Camera I/F Unit

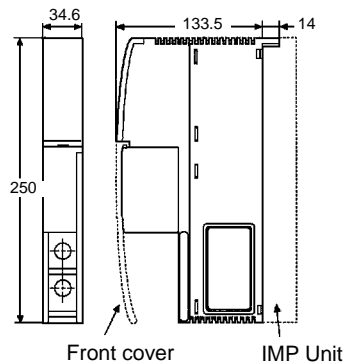

F300-A20R Shutter Camera I/F Unit

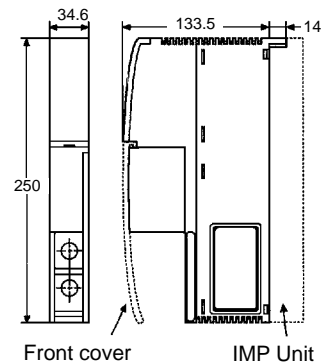

**F300-A20RS/21RS Shutter
Simultaneously Camera I/F Unit**

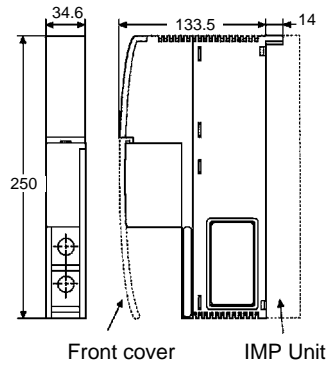

F300-E RS-232C I/F Unit

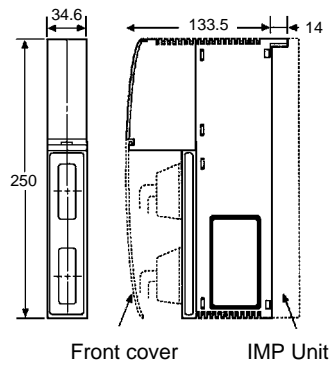

F300-DC Parallel I/O Unit

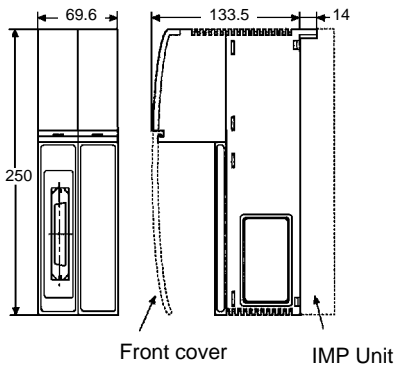

F300-D Terminal Block Unit

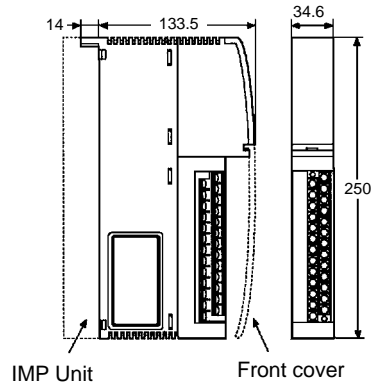

F300-FS Strobe I/F Unit

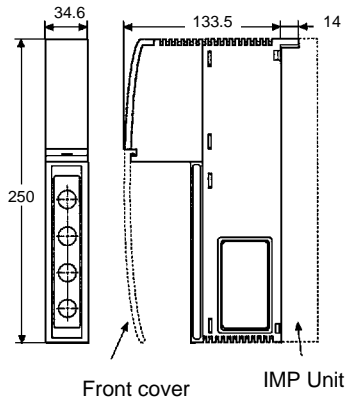

F300-G Dummy Unit

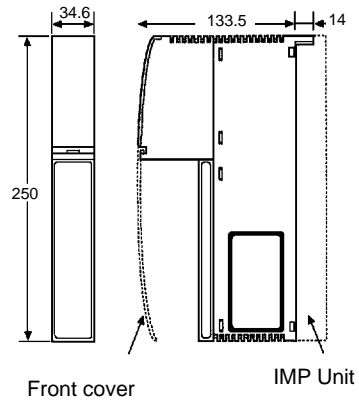

2-6-2 Console

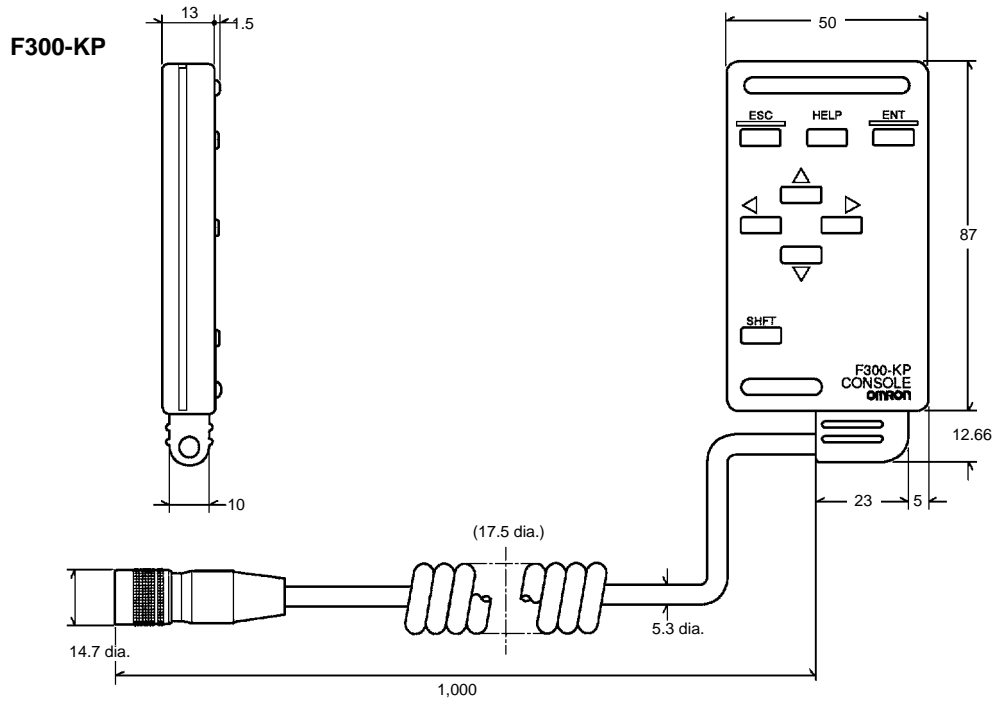

2-6-3 Video Monitor

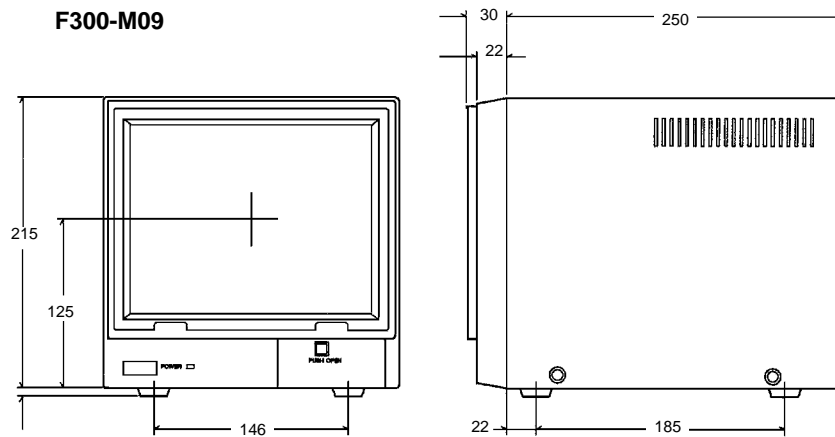

2-6-4 Normal Cameras

F200-S

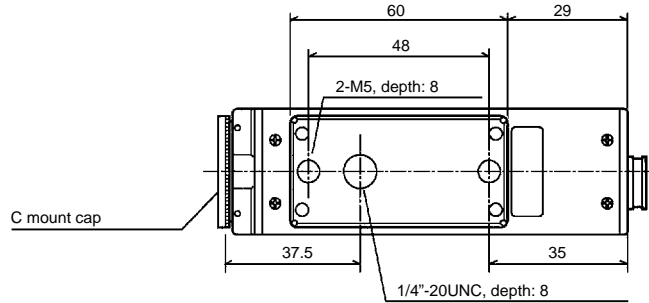
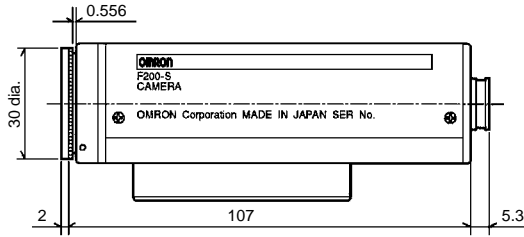
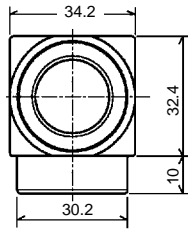

F300-S

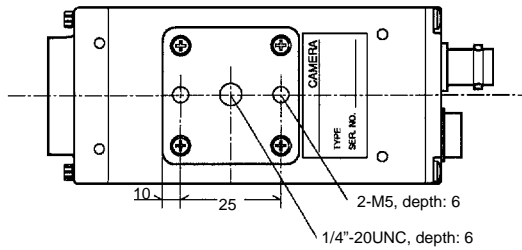
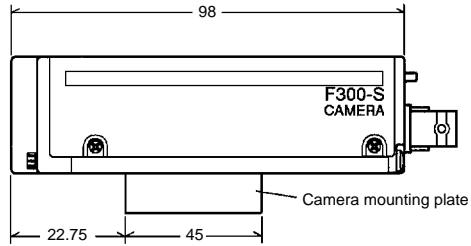
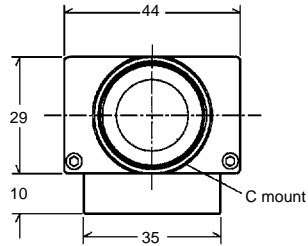

SECTION 3

Menu Operation Flow

This section describes the order of operations used for setting inspection data. The operations used will vary depending on the application (e.g., the object inspected and the contents of the inspection, positioning, and so on). In this section, three examples are used for purposes of general illustration. Section 4 describes related functions and provides more detailed explanations of key operations.

3-1	Inspection for Cans of the Wrong Type	50
3-1-1	Preliminary Operations	51
3-1-2	Menu Procedure	52
3-2	Positioning for Tightening Screws	57
3-2-1	Preliminary Operations	58
3-2-2	Menu Procedure	59
3-3	Inspection of Folded Ends of Packages	65
3-3-1	Preliminary Operations	67
3-3-2	Menu Procedure	67

3-1 Inspection for Cans of the Wrong Type

In this example, the sides of cans are measured and any items of the wrong type are detected. The results of the F200 determination (OK/NG) are then output to a Terminal Block Unit so that the erroneous items can be rejected in the next process. In addition, when each can arrives at the measurement position a STEP signal is input from a synchronization sensor. The measurement is executed by the F200 in synchronicity with the STEP signal.

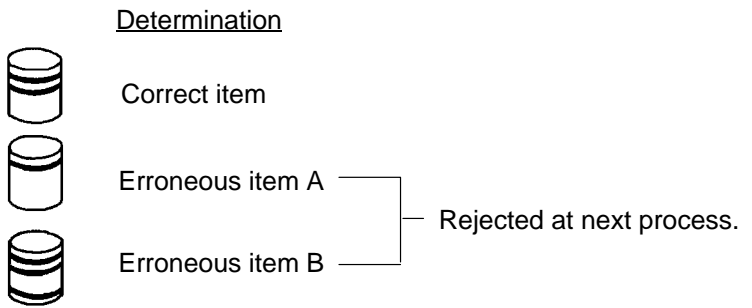
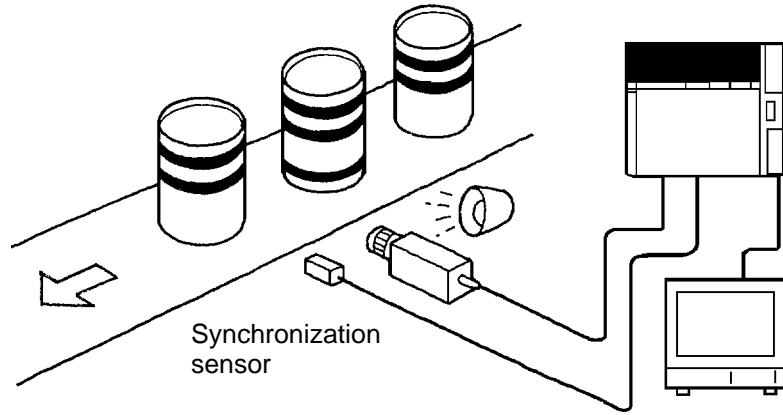

Menu Operation Flow

The flow of menu operations up to the point of measurement is shown below. For detailed explanations of these operations and their related functions, refer to *Section 4 Operations*.

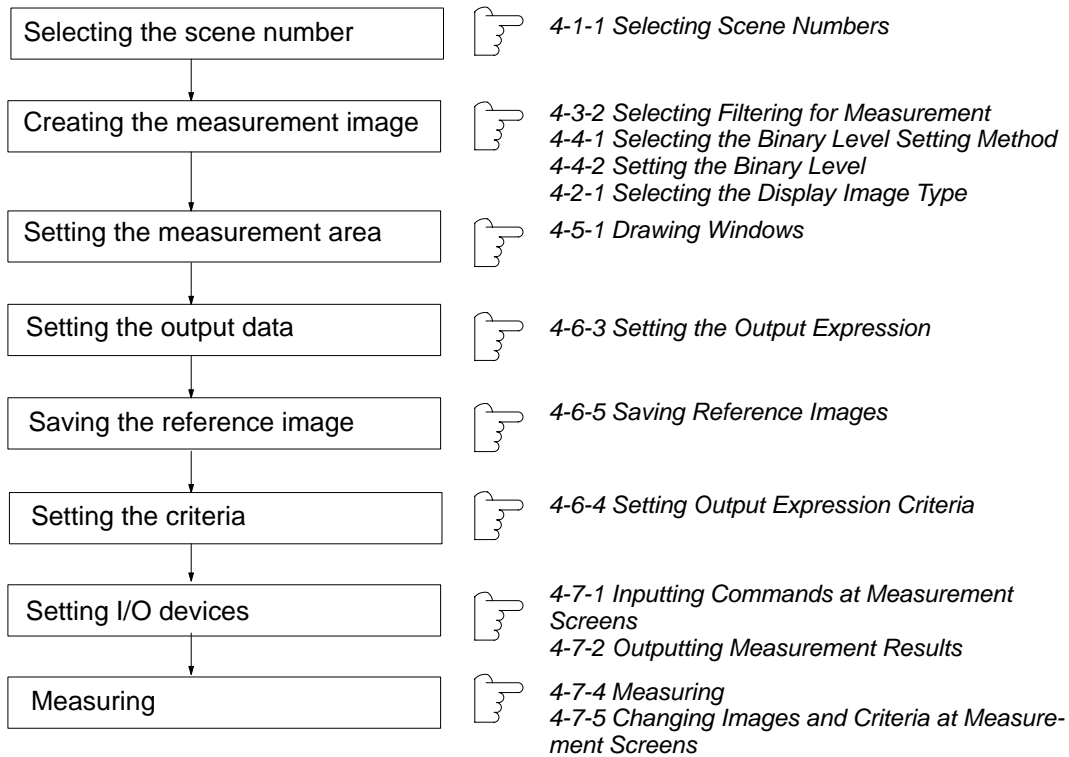

3-1-1 Preliminary Operations

Before menu operations can begin, the following preliminary operations must be carried out.

- Wire the system so that the Terminal Block Unit's determination result output will be processed at the next step.
- Install the cameras so that the following conditions will be satisfied when a can reaches the position that turns ON the STEP signal.
 - 1) The can shall not be out of position on the screen.
 - 2) The cameras shall be in focus.

3-1-2 Menu Procedure

Selecting the Scene Number

- 1, 2, 3... 1. Select Scene 0. From this point on, all data that is set will be set for Scene 0.



Creating the Measurement Image

2. Select the filtering. In order to enhance the pattern of the side of the can, and to stabilize the binary image, select “Edge enhancement level 3.”
3. Set the binary level so that the pattern of the side of the can is displayed as white.

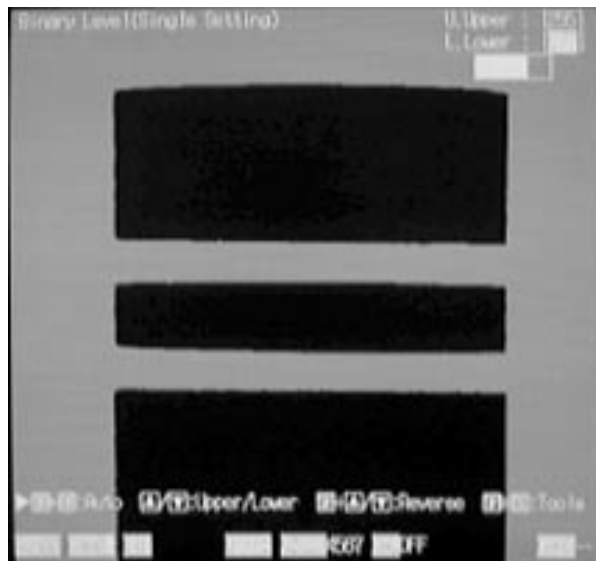

4. Select the displayed image. Select “Binary image” so that the measured binary image will be always displayed.

Setting the Measurement Area

5. Draw the window so that the entire side surface of the can appears in the window (Window 0).



Setting the Output Data

6. Set the area of Window 0 as the output expression.

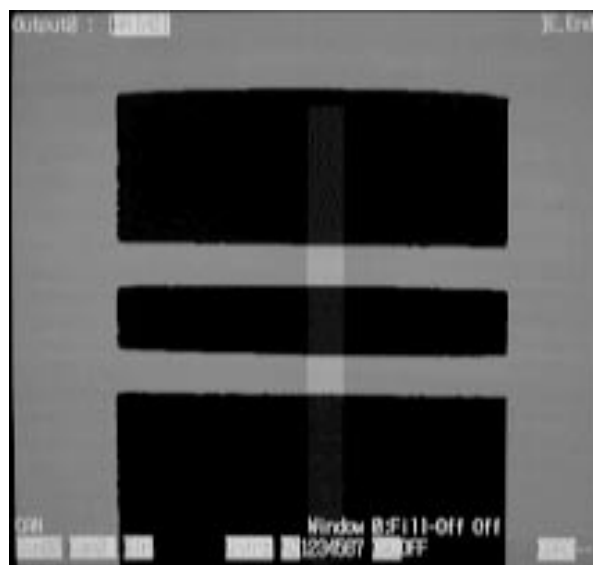

Saving the Reference Image

- 7. Save the area of a correct item as the reference image.

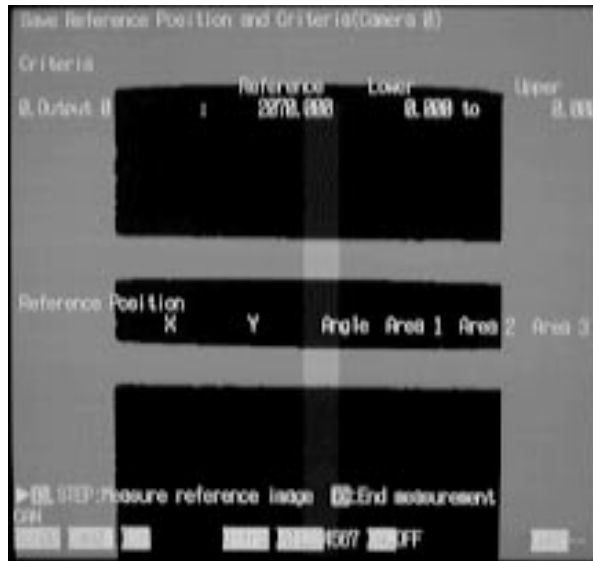

Setting the Criteria

- 8. Set the criteria in the following way. Set the boundary between the measured values for the correct item and erroneous item A as the lower limit, and set the boundary between the measured values for the correct item and erroneous item B as the upper limit.



Setting I/O Devices

- 9. Set the input device by setting "Step signal" to ON.
- 10. Set the output device by setting "I/O Unit, results" to ON.



Measuring

- 11. The measurement is carried out in synchronization with the STEP signal. The area is measured, and the results are output to the Terminal Block Unit.

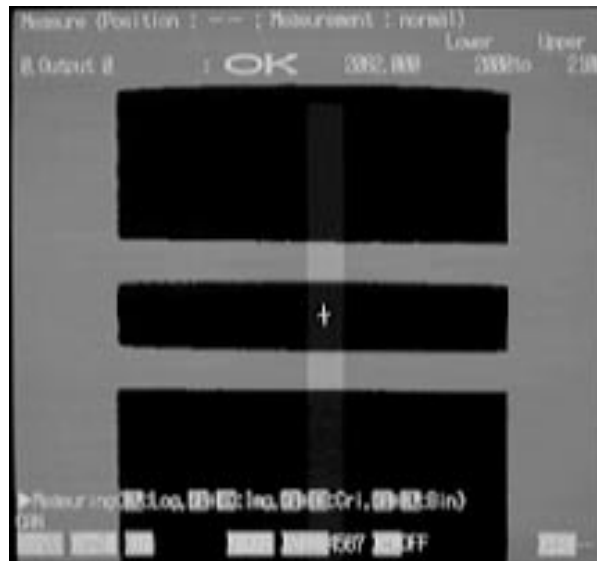

12. Make any necessary adjustments. The binary image may be changed if there is any fluctuation in ambient lighting due to light source deterioration. If the binary image is changed, the data that is set cannot be measured correctly. Therefore, it may be necessary to adjust the binary image and the criteria.



3-2 Positioning for Tightening Screws

In this example, the centers of the markers for screw positions on a baseboard are measured and positioning is carried out. In the F200 System, the measurement results (i.e., the centers of the markers) are output via RS-232C so that a motor driver can guide the positioning.

When the printed circuit board arrives at the position where the measurement is to be carried out, a STEP signal is input to the F200 System from a synchronization sensor. The F200 System carries out the measurement in synchronization with the STEP signal. Position displacement compensation can be set so that measurement is always carried out at the markers even if the printed circuit board is out of alignment.

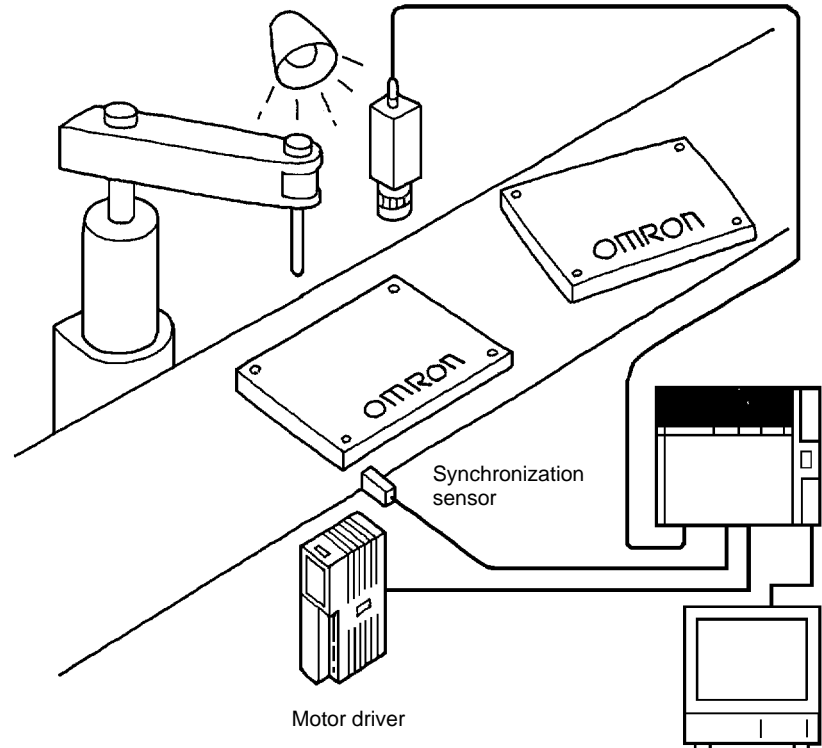

Menu Operation Flow

The flow of menu operations up to the point of measurement is shown below. For detailed explanations of these operations and their related functions, refer to *Section 4 Operations*.

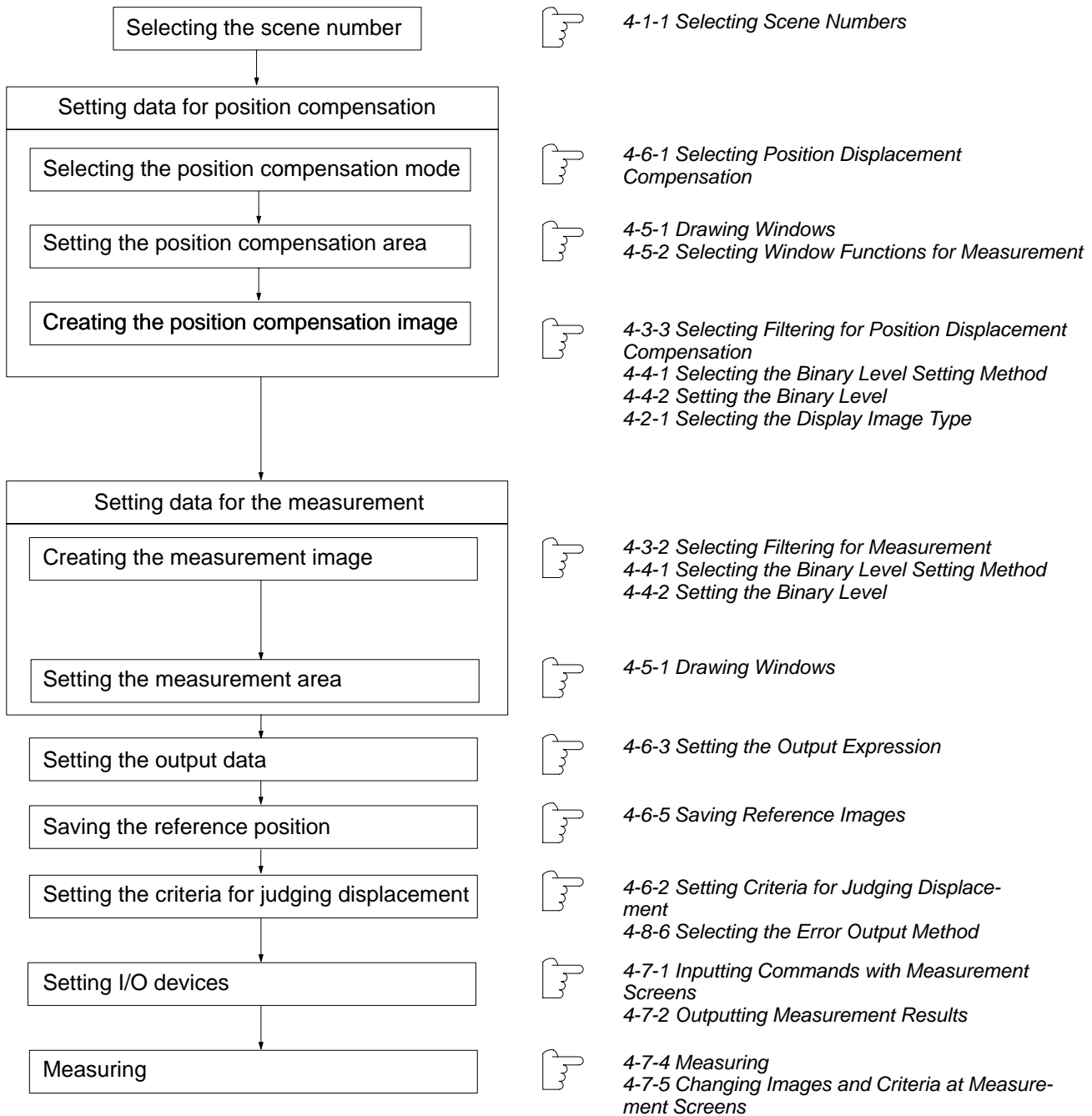
**3-2-1 Preliminary Operations**

Before menu operations can begin, the following preliminary operations must be carried out.

- Connect the F200 to the controller section of the motor driver by means of RS-232C. Refer to 2-5-4 *Connecting RS-232C I/F Units*.
- Install the cameras so that the following conditions will be satisfied when a printed circuit board reaches the position that turns ON the STEP signal.
 - 1) The printed circuit board shall not be out of position on the screen.
 - 2) The cameras shall be in focus.

3-2-2 Menu Procedure

Selecting the Scene Number

- 1, 2, 3... 1. Select Scene 1. From this point on, all data that is set will be set for Scene 1.

Setting Data for Position Compensation

2. Set position displacement compensation. Measure the amount of position displacement compensation from the center of gravity and the axis angle of the printed circuit board's outer dimensions. Use Window 0 and select the normal mode.

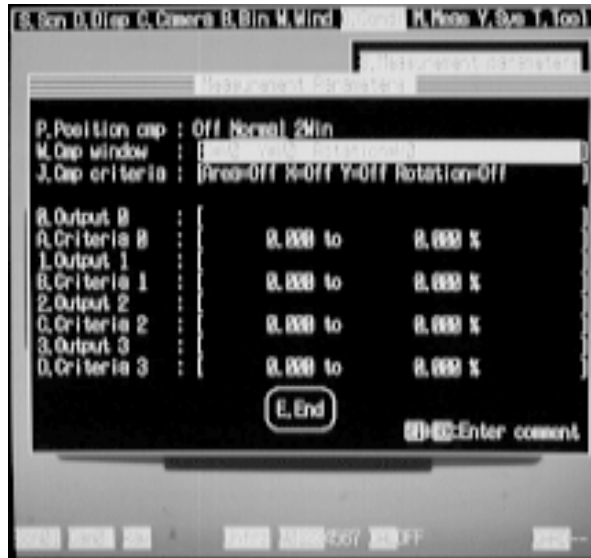

3. Set the position displacement compensation area. Draw a window for position compensation (Window 0) in such a way that the image will fit within the window even if there are variations in the positions of the printed circuit board.



Then set the contour fill measurement. All the pixels within the contours of the printed circuit board will turn white, and position displacement compensation from the outer dimensions will be reliable.

4. Create the position displacement compensation image. Select "Edge enhancement level 1" for position displacement compensation filtering.

- 5. Set the binary level for position displacement compensation so that the entire printed circuit board becomes white (Window 0).

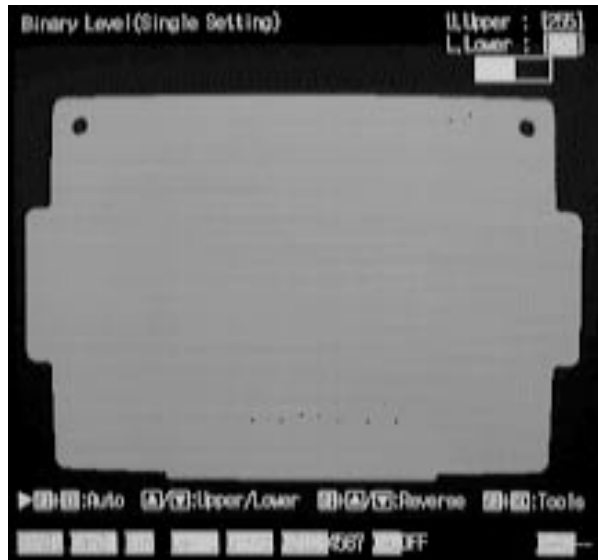

- 6. Select the displayed image. Select “Binary image” so that the measured binary image will be always displayed.

Setting Data for Measurement

- 7. Draw the windows for measurement on top of the marks (Windows 1 and 2).



- 8. Select the filtering for the measurement. In order to eliminate noise, select “Weak smoothing.”

- Set the binary level for the measurement so that the marks will be displayed in white.

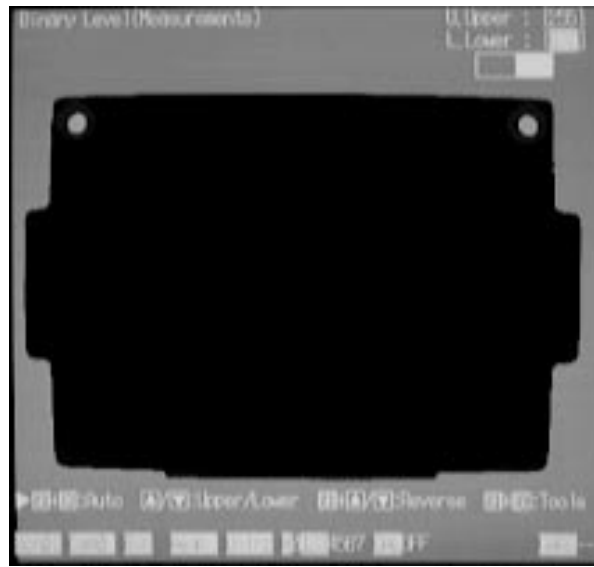

Setting the Output Data

- Set the output expression. Set the center of gravity X and Y coordinates for each mark.



Saving the Reference Position

11. Save the reference position for position displacement compensation.



Setting the Criteria for the Amount of Position Displacement

12. Determine the amount of position displacement. Set the criteria and select the output method for NG.



Setting I/O Devices

13. Set the input device by setting "Console" and "STEP signal" to ON.
14. Set the output device by setting "RS-232C measurement" to ON.



Measuring

15. Measurement is carried out in synchronization with the STEP signal. Even if the printed circuit board is slanted, the mark positions are always measured. If the result of the determination of position displacement is NG, an error is output.

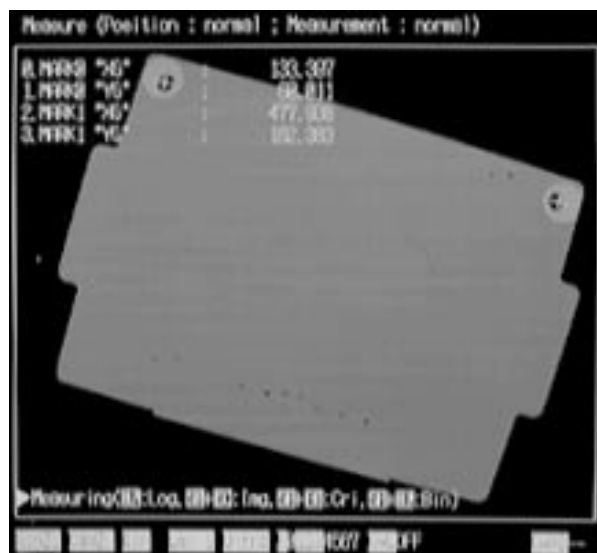

- 16. Make any necessary adjustments. The binary images can change if there are changes in illumination or fluctuations in ambient brightness, and if binary images change then the data that has been set cannot be properly measured. In such cases, the binary level and criteria must be adjusted.

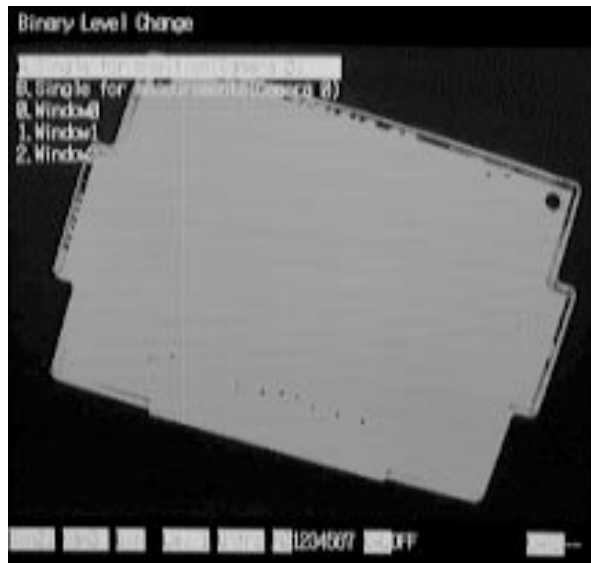

3-3 Inspection of Folded Ends of Packages

In this example, two cameras are used to inspect both ends of packages simultaneously. The area is measured and erroneous folding is recognized. The results of the F200 determination (OK/NG) are then output to a Terminal Block Unit so that the erroneous items can be rejected in the next process. In addition, when each box arrives at the measurement position a STEP signal is input from a synchronization sensor. The measurement is executed by the F200 in synchronicity with the STEP signal.

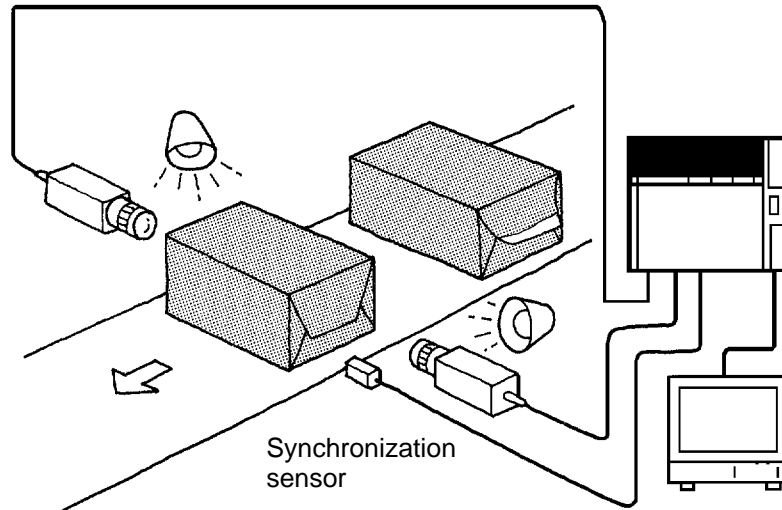

Determination



Correct item

Erroneous item A

Erroneous item B

Rejected at next process.

Menu Operation Flow

The flow of menu operations up to the point of measurement is shown below. For detailed explanations of these operations and their related functions, refer to *Section 4 Operations*.

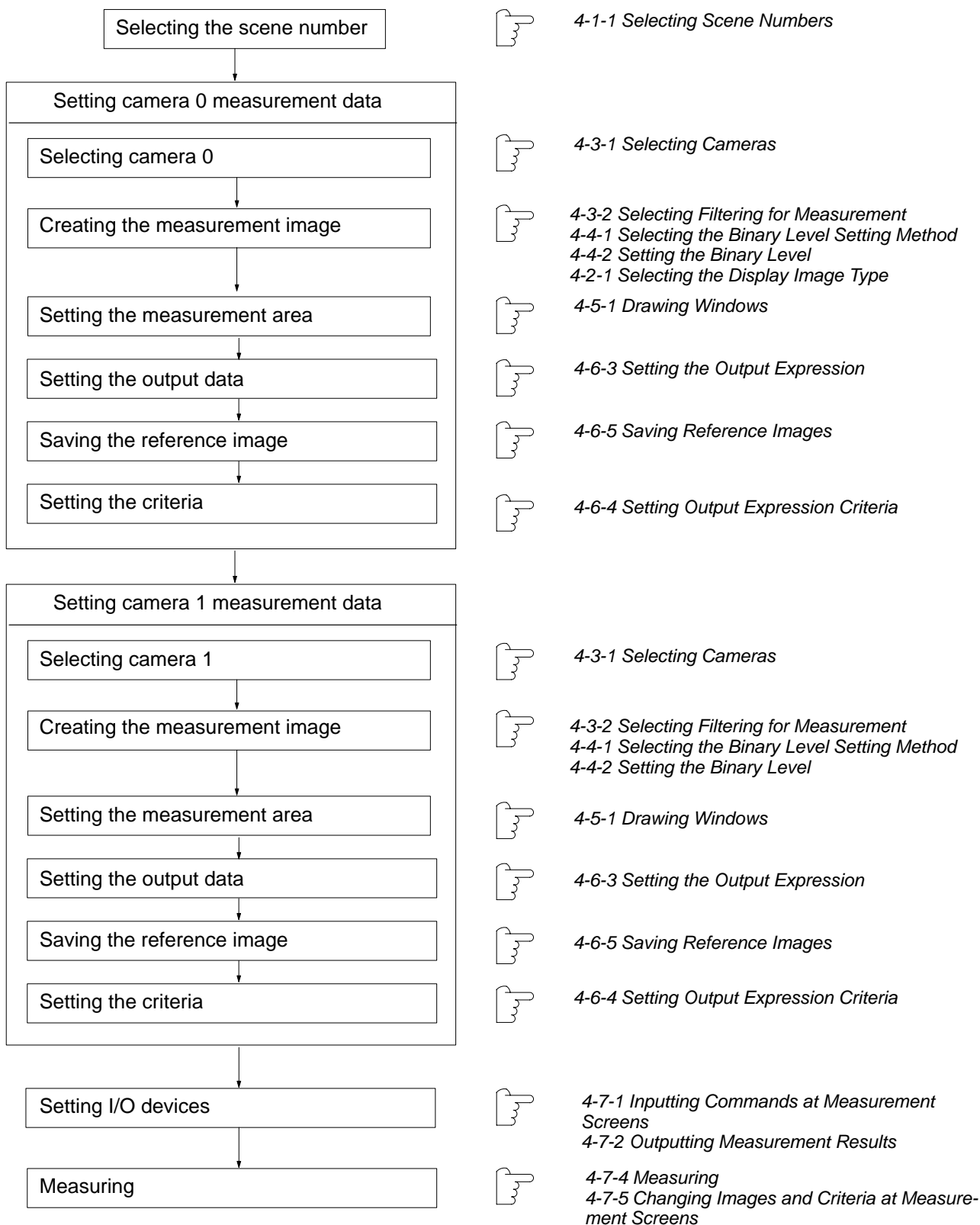

3-3-1 Preliminary Operations

Before menu operations can begin, the following preliminary operations must be carried out.

- Wire the system so that the Terminal Block Unit's determination result output will be processed at the next step.
- Install the cameras so that the following conditions will be satisfied when a package reaches the position that turns ON the STEP signal.
 - 1) The package shall not be out of position on the screen.
 - 2) The cameras shall be in focus.

3-3-2 Menu Procedure

Selecting the Scene Number

- 1, 2, 3... 1. Select Scene 1. From this point on, all data that is set will be set for Scene 1.

Setting Camera 0 Measurement Data

2. Select camera 0. Set the data pertaining to camera 0.
3. Select the filtering.
4. Set the binary level so that the overlapping edges are white.

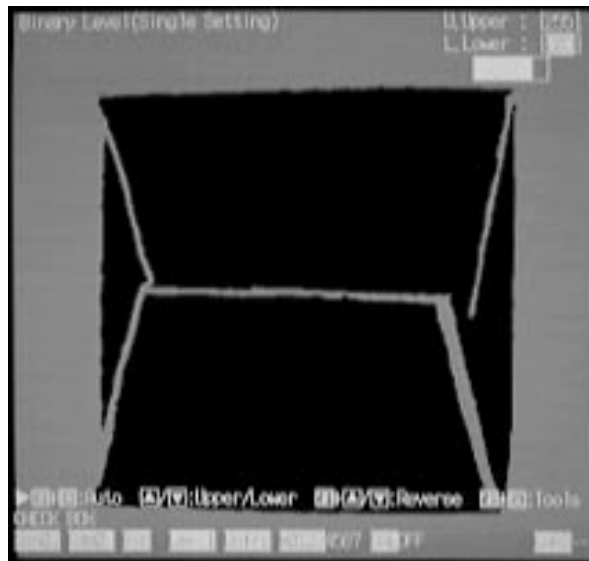

5. Select the displayed image. Select "Binary image" so that the measured binary image will be always displayed.

6. Draw the window so that the entire end of the box appears in the window (Window 0).

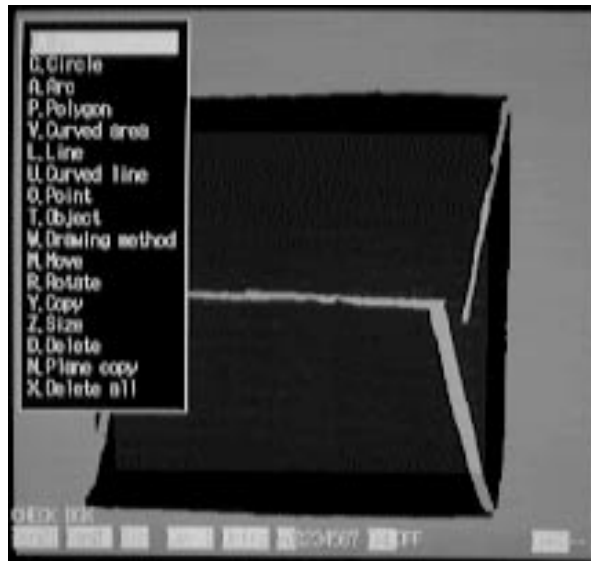

7. Set the area of Window 0 as the output expression.

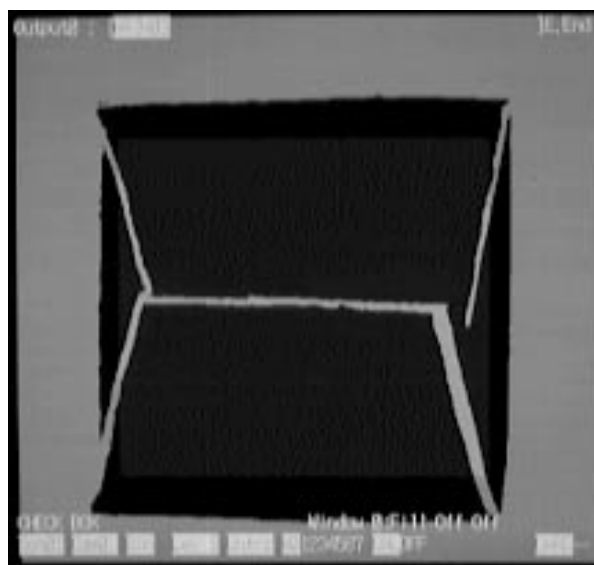

8. Save the area of a good item as the reference image. The output expression set in step 7 above is measured and saved as the reference image.

- Using the console, measure the area of an erroneous item. The measurement results will be displayed on the screen. Make note of the area of the erroneous item.

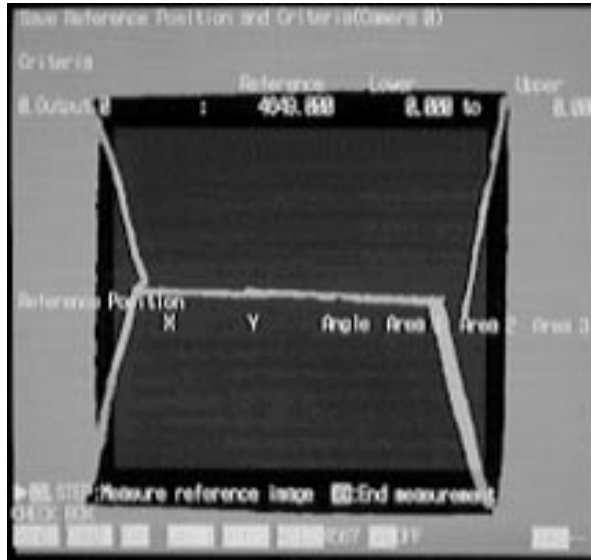

- Set the criteria. Taking the areas measured in steps 8 and 9 above, set the upper and lower limits for the criteria. Set the boundary between the good item and the erroneous item as the lower limit.



Setting Camera 1 Measurement Data

Set data like camera 0.

Setting I/O Devices

11. Set the input device by setting "STEP signal" to ON.
12. Set the output device by setting "I/O Unit, results" to ON.



Measuring

13. The measurement is carried out in synchronization with the STEP signal. The area is measured, and the results are output to the Terminal Block Unit.

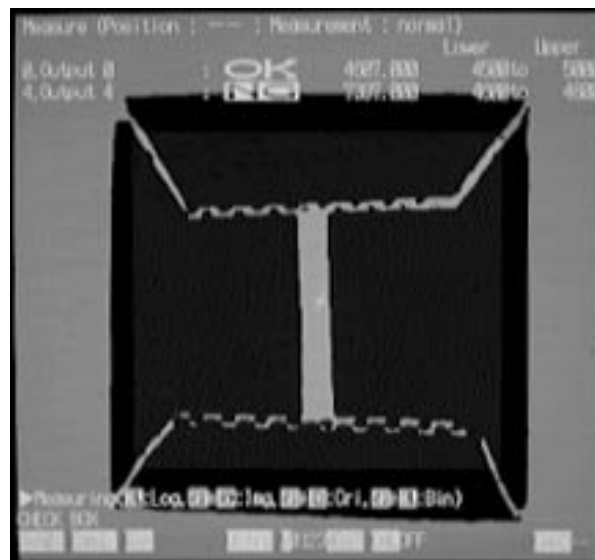

SECTION 4

Operations

This section explains the operations that can be accessed through the menu bar.

4-1	Scenes	74
4-1-1	Selecting Scene Numbers	74
4-1-2	Copying Scene Data	75
4-1-3	Clearing Scene Data	77
4-1-4	Entering Scene Comments	78
4-1-5	Determining Scene Change Times	79
4-2	Displays	80
4-2-1	Selecting the Display Image Type	81
4-2-2	Selecting the Image Display Method	83
4-2-3	Displaying Windows	87
4-3	Cameras	90
4-3-1	Selecting Cameras	90
4-3-2	Selecting Filtering for Measurement	90
4-3-3	Selecting Filtering for Position Displacement Compensation	93
4-3-4	Flashing the Strobe	94
4-3-5	Creating Data for Converting to Actual Dimensions	95
4-3-6	Checking Data Set by C. Camera	104
4-4	Binary	105
4-4-1	Selecting the Binary Level Setting Method	105
4-4-2	Setting the Binary Level	106
4-5	Windows	110
4-5-1	Drawing Windows	110
4-5-2	Selecting Window Functions for Measurement	117
4-5-3	Checking Data Set by W. Window	120
4-6	Conditions	120
4-6-1	Setting Position Displacement Compensation	120
4-6-2	Setting Criteria for Judging Displacement	125
4-6-3	Setting the Output Expression	126
4-6-4	Setting Output Expression Criteria	134
4-6-5	Saving Reference Images	136
4-6-6	Checking Data Set by O. Conditions	139
4-7	Measurement	140
4-7-1	Inputting Commands at Measurement Screens	140
4-7-2	Outputting Measurement Results	146
4-7-3	Outputting Measured Values in Actual Dimensions	152
4-7-4	Measuring	153
4-7-5	Changing Images and Criteria at Measurement Screens	153
4-8	System	157
4-8-1	Automatic Measuring	158
4-8-2	Setting RS-232C Communications Specifications	159
4-8-3	Setting Parallel Data Output Specifications	162
4-8-4	Setting Specifications for Connected Cameras	165
4-8-5	Setting Measurement Speeds	166
4-8-6	Selecting the Error Output Method	167
4-8-7	Selecting the Menu Display Method	169
4-8-8	Checking Connected Units	170
4-9	Tools	171
4-9-1	Histograms	171
4-9-2	Line Brightness	172
4-9-3	Density Graph	173
4-9-4	Saving and Loading System Data	174
4-9-5	Saving and Loading Scene Data	179
4-9-6	Initializing and Editing Memory Cards	184

4-1 Scenes

A scene is a program area for saving contents and methods of measurement. The F200 has 16 scenes (numbered from 0 to 15), so switching among 16 ways of measuring can be carried out simply by saving a measurement method for each scene and then switching among the different scene numbers. For each scene, it is necessary to set scene data such as the image and area to be measured, the measurement item, and so on. For the items on the main menu bar, such as "S. Scene," "D. Display," "C. Camera," "B. Binary," "W. Window," "O. Conditions," "M. Measurement," the various settings related to measurements are all saved as data for selected scene numbers.

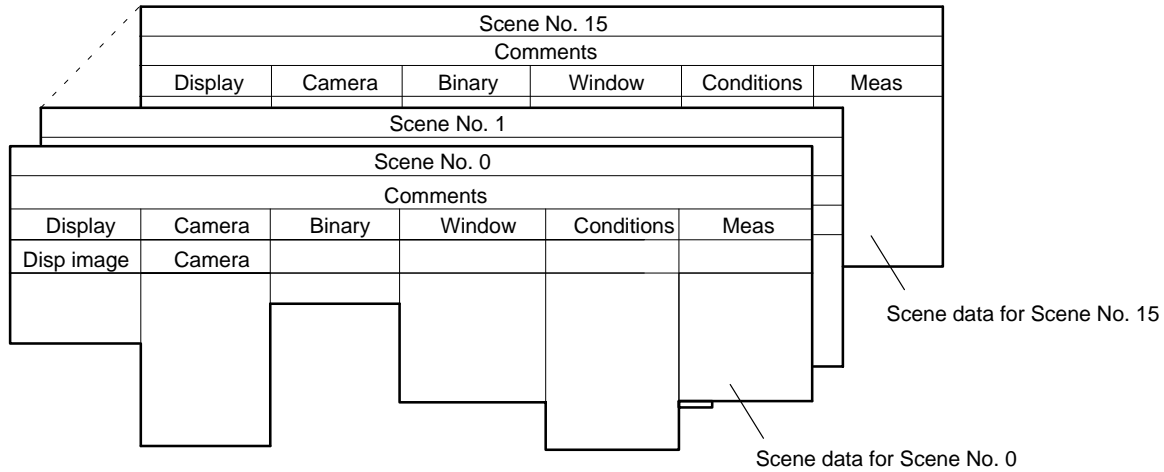

S. Scene

With "S. Scene," the scene number can be selected and the scene data can be edited. The operations accessed in the submenu shown below are explained on subsequent pages. To display a list of scene numbers, select S. Scene from the menu bar.

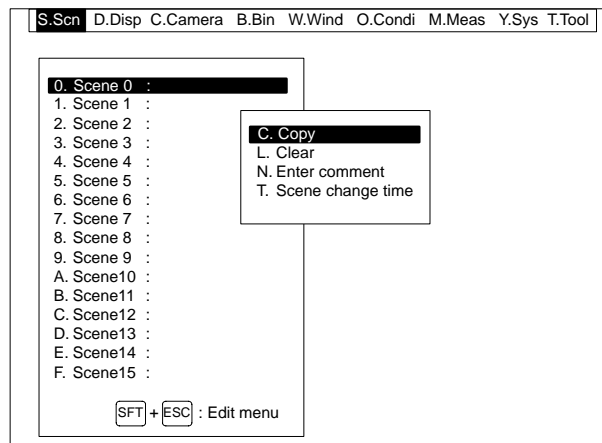

4-1-1 Selecting Scene Numbers

Select the scene numbers for setting scene data and carrying out measurements. (When the system is powered up, the scene that is displayed first will be the scene that was being displayed just before the power was last turned off. The scene number is factory set to Scene 0, so initially that scene number will be highlighted (i.e., displayed in reverse video). When executing automatic measurements, the measurement screen for the scene number that is set will be displayed. For details, refer to 4-8-1 Automatic Measuring.

- 1, 2, 3...** 1. Select a scene number.

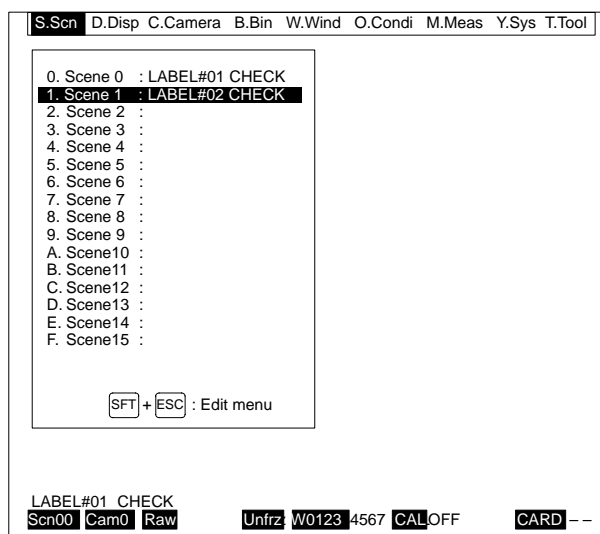

2. The selected scene will be displayed. Scene data can then be set and measurements can be carried out with respect to that scene. If any comments have been entered for a particular scene, they will be displayed. For details, refer to *4-1-4 Entering Scene Comments*.



4-1-2 Copying Scene Data

The scene data from a designated scene number can be copied to another scene number. This is quite convenient when, for example, only the window and output format need to be changed and the rest of the existing scene data can be used as is.

- 1, 2, 3...**
1. Move the cursor to the scene number of the copy destination.
 2. Press the Shift and Escape Keys. The Edit menu will then be displayed.

3. Select "C. Copy."

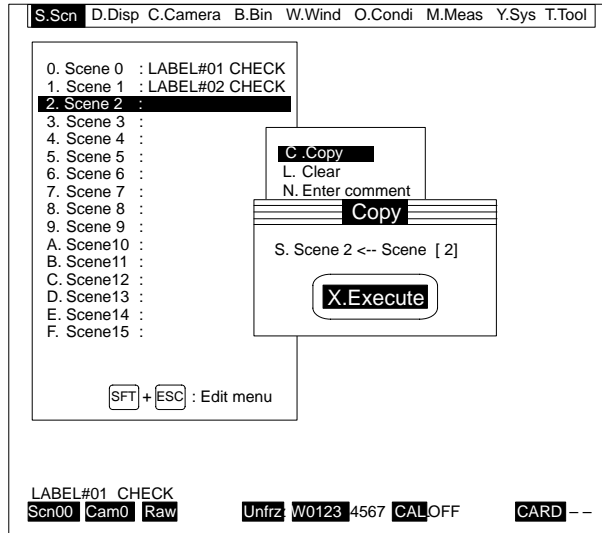

4. Enter the scene number of the copy source.

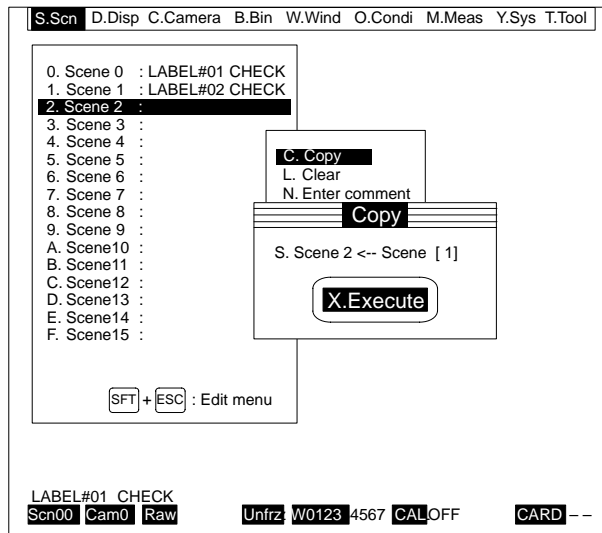

5. Select "X. Execute." A message will be displayed asking for confirmation.

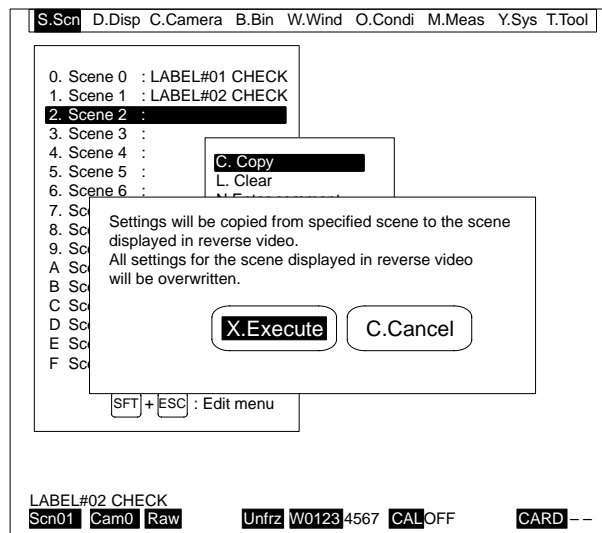

6. Select "X. Execute." The scene data will then be copied from the copy source to the copy destination.

- Note**
1. Copying will take longer if there are many windows at the copy source or if the windows are particularly complex.
 2. Be careful not to turn off the power supply while scene data is being copied.

4-1-3 Clearing Scene Data

The scene data for a designated scene number can be cleared, i.e., returned to the initial (factory set) values. Once scene data has been set, it is not cleared just by turning off the power supply. When setting new data, first clear the existing scene data.

- 1, 2, 3... 1. Move the cursor to the scene number for which the data is to be cleared.

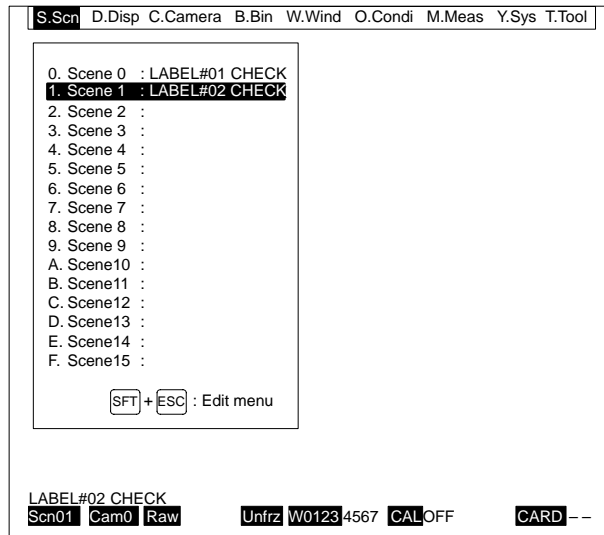

2. Press the Shift and Escape Keys. The Edit menu will then be displayed.
3. Select "L. Clear." A message will be displayed asking for confirmation.

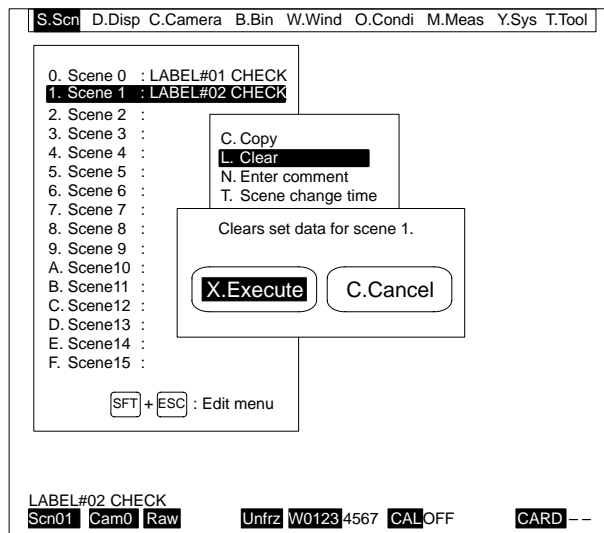

4. Recheck the scene number, and then select "X. Execute." The data for the designated scene will all be returned to the initial values.

4-1-4 Entering Scene Comments

For each scene, a comment (e.g., a name or title) of up to 16 letters or numbers can be entered. Comments can include items such as the contents of inspections, names of manufacturing processes, and so on, and can be helpful in managing scene data.

An entered comment is displayed on the lower left hand side while the relevant scene for the comment is being set.

- 1, 2, 3... 1. Move the cursor to the scene number for which a comment is to be entered.
2. Press the Shift and Escape Keys. The Edit menu will then be displayed.

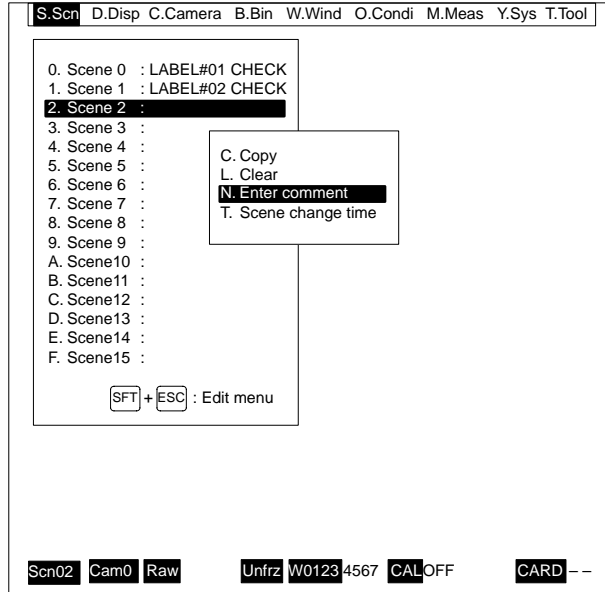

3. Select "N. Enter comment."
4. Enter the comment. For instructions on inputting characters, refer to 1-4-5 *Inputting Characters*.

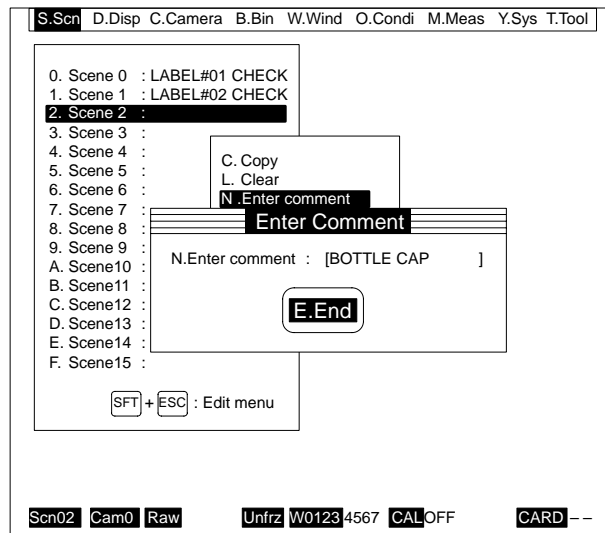

5. Select "E. End." The comment will be set.

6. The following screen will be displayed.

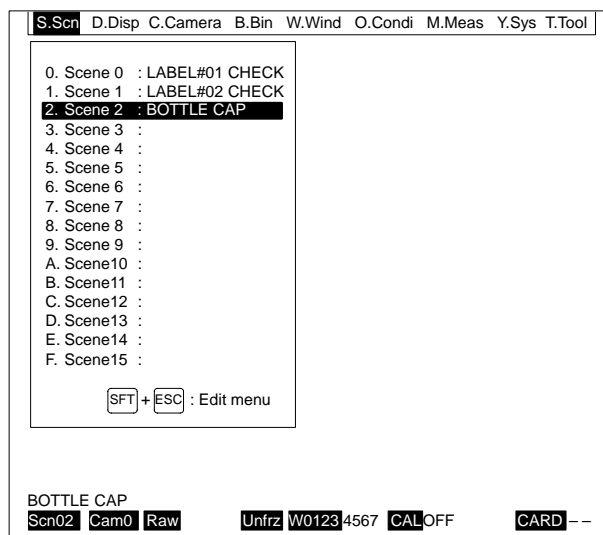

4-1-5 Determining Scene Change Times

When switching scenes to carry out a measurement, no measurement can be executed while the scenes are being changed. The change time will vary depending on the scene data that is set. If it seems to be affecting the input timing of measurement commands, check the change time in advance before executing the measurement. The time is displayed in units of 10 ms.

- 1, 2, 3...**
1. Move the cursor to the scene for which the change time is to be determined. The change time is the time it takes to switch to that scene, and it makes no difference which scene is currently being displayed.
 2. Press the Shift and Escape Keys. The Edit menu will then be displayed.

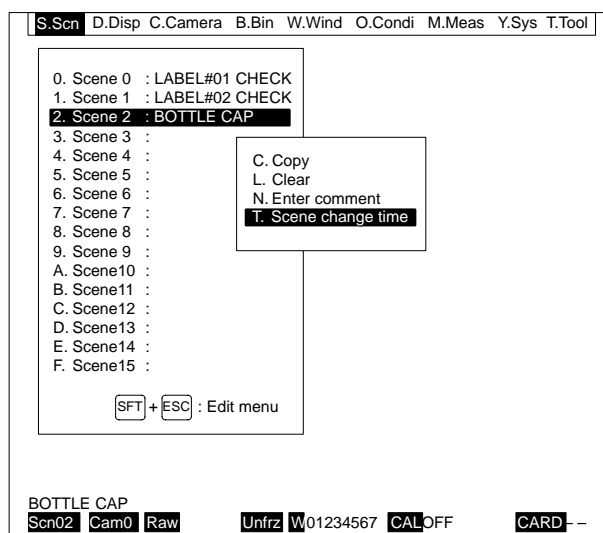

- 3. Select "T. Scene change time." A message will be displayed asking for confirmation.

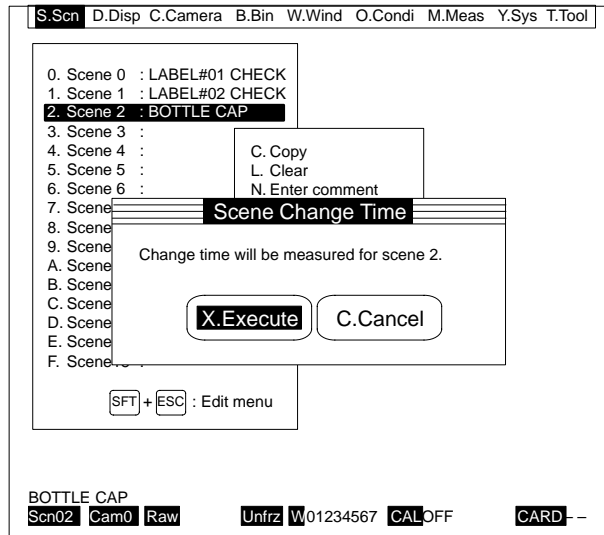

- 4. Select "X. Execute." The change time will be displayed in units of 10 ms.

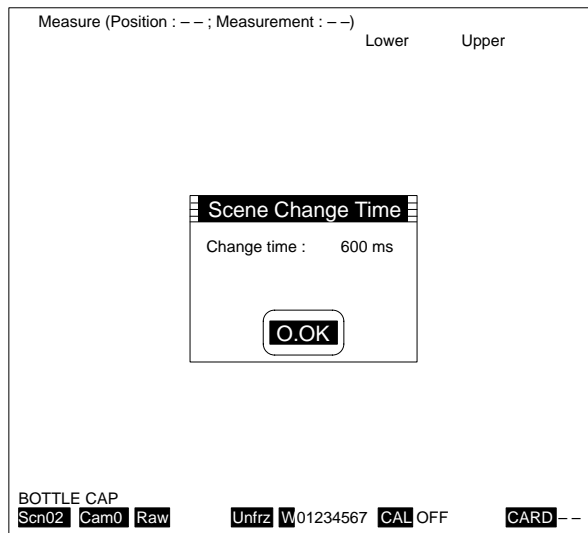

- 5. Select "O. OK."

4-2 Displays

D. Display

With "D. Display," the types of images that will be displayed on the video monitor can be set, along with the methods for displaying them. "D. Display," simply sets the type of image that is to be displayed, and has no effect on actual measurement conditions. It can be used to provide the most suitable displays when setting scene data or monitoring measurement conditions. The operations accessed in the submenu shown below are explained on subsequent pages.

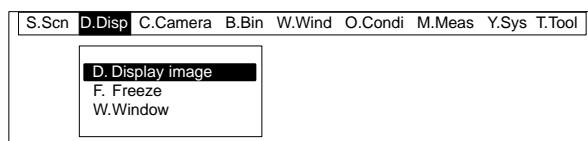

4-2-1 Selecting the Display Image Type

Any of three types of image (raw image, filtered image or binary image) can be selected for display. The default setting is for raw images from the camera to be displayed. Use raw images for operations such as conducting checks or adjusting the focus.

If “Filtered image” is selected, the image will be displayed in filtered format. Filtered images cannot be displayed, however, on measurement screens. For more details, refer to *4-3-2 Selecting Filtering for Measurement* and *4-3-3 Selecting Filtering for Position Displacement Compensation*.

If “Binary image” is selected, the image will be displayed in binary format at the binary level that is currently set. Select “Binary image” to check the binary image of the object that is to be measured. For more details, refer to *4-4-2 Setting the Binary Level*.

The display image can be changed from any menu. When the Shift and Escape Keys are pressed simultaneously, the same screen will be displayed as when “D. Display image” is selected. The display image cannot be changed, however, at screens where a different operation is executed by the pressing the Shift and Escape Keys (such as the basic screen, where the version is displayed by pressing those keys), or where graphics are drawn (for example, while graphics are being drawn by means of “W. Drawing window”). After the image type has been selected, the screen where the Shift and Escape Keys were pressed will return.

Raw Image

The raw image is the unaltered image from the camera.

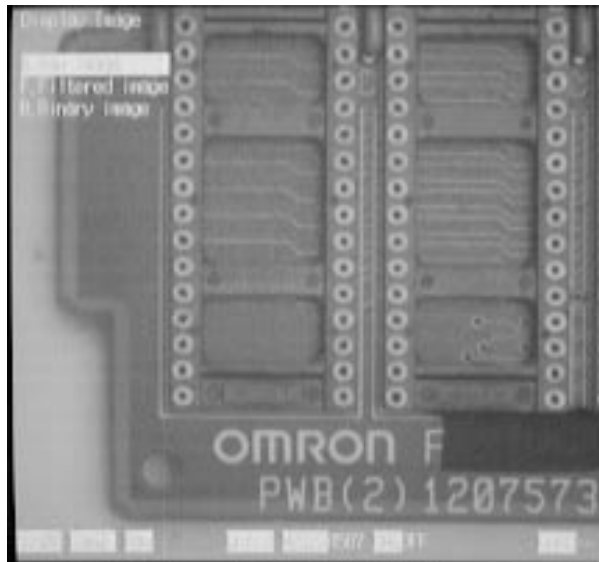

Filtered Image

The filtered image is the image from the camera after processes such as edge enhancement have been carried out. When image filtering is set to OFF, the raw image will be displayed. If the filtering for the measurement and for position displacement compensation are different, the filtered image for the measurement will be displayed during the setting of scene data. The filtered image for position displacement compensation will be displayed, however, at measurement screens.

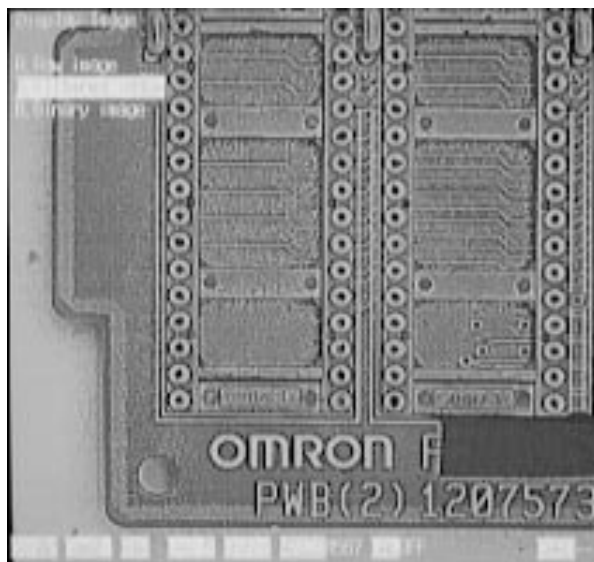

Binary Image

The binary image displays the image from the camera in binary. If a different binary level is set for each window, then the binary image will be displayed at the binary level that is set for the lowest numbered window of the windows currently being displayed.

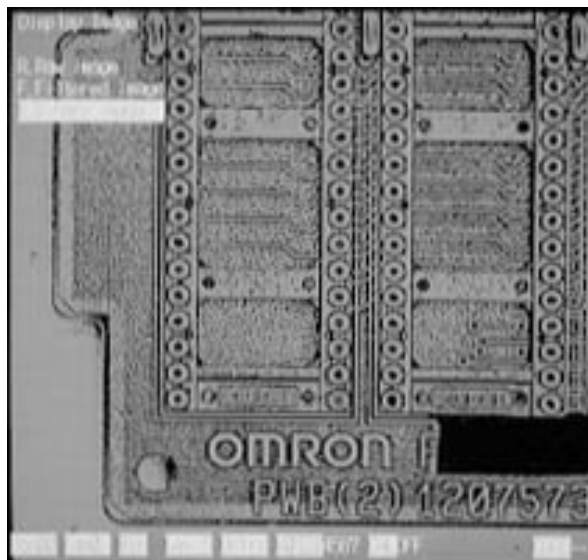

Procedure

Follow the procedure outlined below to select the image type.

- 1, 2, 3... 1. Select "D. Display image."
- 2. Select the type of image to be displayed. The image will then be displayed according to the selected image type.

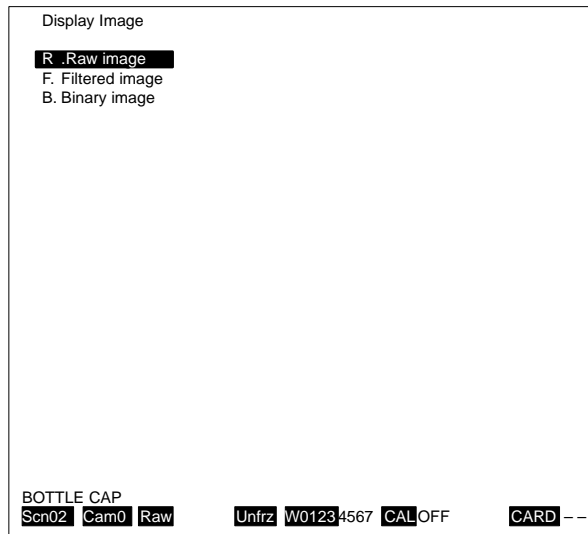

4-2-2 Selecting the Image Display Method

The image to be displayed on the video monitor can be set as either frozen (still) or unfrozen (moving). To display images just as they are taken by the camera, select "Unfreeze," and to display them as still images, select "Freeze." By selecting "Freeze," measurement objects moving at high speed can be displayed as still images for measurement. In addition, the frozen images can be saved to a memory card.

Setting "Unfreeze"

- 1, 2, 3... 1. Select "F. Freeze."

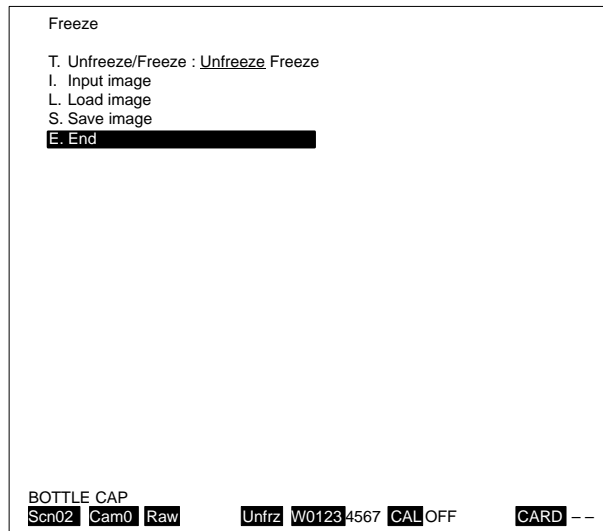

- 2. From within "T. Unfreeze/Freeze," select "Unfreeze." The image will then be displayed as unfrozen.
- 3. Select "E. End." "Unfreeze" will then be set.

Note 1. If the strobe light is set to ON, the strobe will flash continuously.

- If a Camera Unit other than the F300-A20 Normal Camera I/F Unit is used, images will always be frozen at measurement screens.

Setting “Freeze”

When image displays are set to “Freeze,” images are taken according to the timing shown in the table below.

Operation	Timing for Image Taking
Starting up	When the camera image is displayed.
C. Camera/C. Camera	When camera numbers are changed. No images are taken, however, if the F300-A20S Normal Simultaneously Camera I/F Unit or the F300-A20RS Shutter Simultaneously Camera I/F Unit is used.
A. Calibration/S. Sampling/ S. Settings/A. Sampling	When “S. Save” is executed. (Note: Unfrozen images are always displayed at sampling screens.)
O. Conditions/R. Reference image	When two cameras are being used and the Enter Key is pressed or a STEP signal is input. No images are taken, however, if the F300-A20S Normal Simultaneously Camera I/F Unit or the F300-A20RS Shutter Simultaneously Camera I/F Unit is used.
M. Measurement/M. Measure	When a measurement command is input.
T. Tool/H. Histogram or B. Binary/ H. Histogram	When the area is set. If a Camera Unit other than the F300-A20 Normal Camera I/F Unit is used, however, no images will be taken.
T. Tool/L. Line bright or B. Binary/ L. Line bright	When a line is set. If a Camera Unit other than the F300-A20 Normal Camera I/F Unit is used, however, no images will be taken.
T. Tool/D. Density graph	When the Enter Key is pressed. If a Camera Unit other than the F300-A20 Normal Camera I/F Unit is used, however, no images will be taken.

- Note**
- If the strobe light is set to ON, the strobe will flash simultaneously as images are taken.
 - There are three procedures involved in freezing images:
 - Freezing an image when “Freeze” is set
 - Freezing an image when the Enter Key is pressed or a STEP signal is input
 - Loading a saved image to a memory card and freezing it

Freezing When “Freeze” is Set

- 1, 2, 3...**
- Select “F. Freeze.”
 - Display the image that is to be frozen.
 - From within “T. Unfreeze/Freeze,” select “Freeze.” The image that was displayed when the cursor was moved to “Freeze” will then be displayed as frozen.

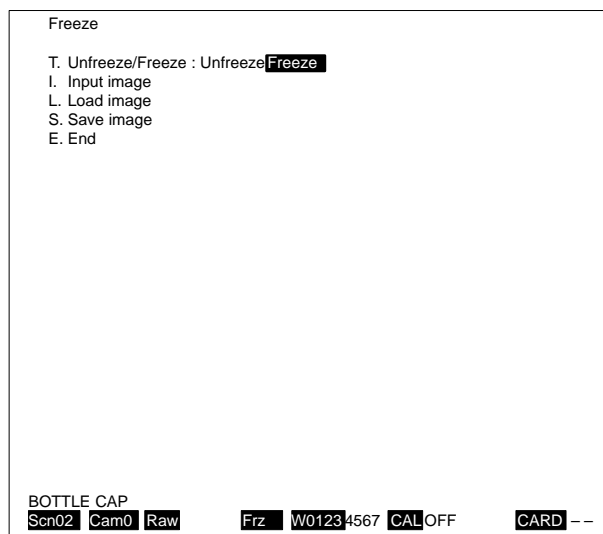

- Select “E. End.” The image will then be set to “Freeze.”

Freezing When the Enter Key is Pressed or a STEP Signal is Input

In order for STEP signals to be input, they must be wired.

- 1, 2, 3...
1. Select "F. Freeze."
 2. Select "I. Input image."



3. Display the image that is to be frozen.
4. Press the Enter Key or input a STEP signal. The image that was displayed when the Enter Key was pressed or the STEP signal was input will then be displayed as frozen.
5. Select "E. End." The image will then be set to "Freeze".

Loading a Saved Image to a Memory Card and Freezing It

Save the image data to a memory card in advance. For details, refer to *Saving Image Data* on the following page.

- 1, 2, 3...
1. Install the memory card which contains the image data.
 2. Select "F. Freeze."
 3. Select "L. Load image."
- All the image data in the memory card will be displayed.

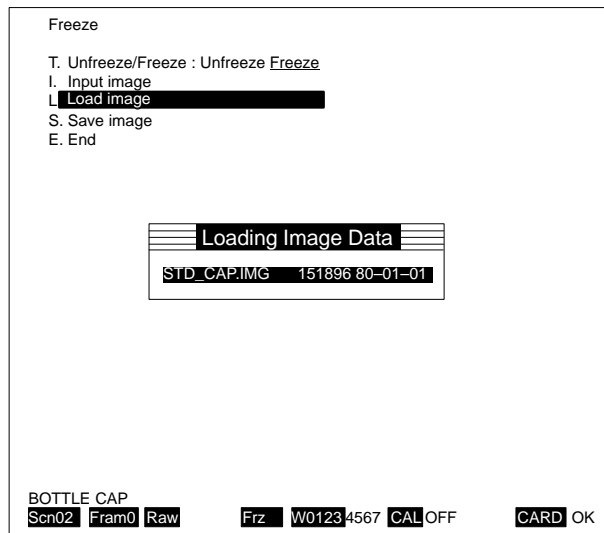

4. Select the filename of the file that is to be loaded. A message will be displayed asking for confirmation.

5. Select "X. Execute." After the loading has been completed, a message will be displayed asking for confirmation.

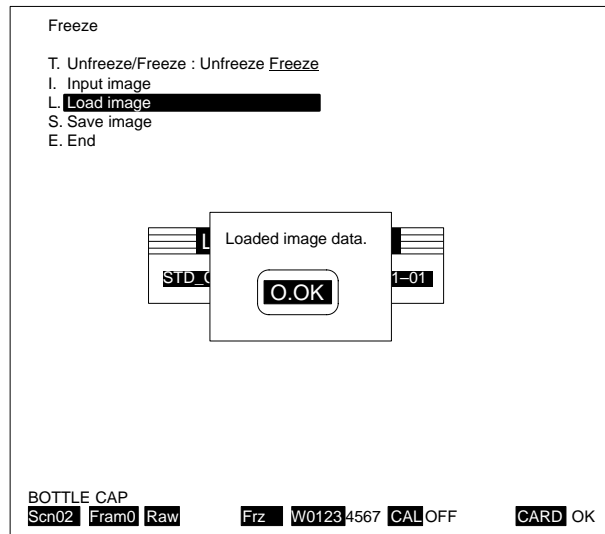

6. Select "O. OK." The image that was loaded will be displayed as frozen.
7. Select "E. End." The frozen image will be set.

Saving Image Data

Before image data is saved, the memory card must be initialized in advance. For instructions on initializing memory cards, refer to 4-9-6 *Initializing and Editing Memory Cards*.

- 1, 2, 3... 1. Install the memory card.
2. Select "F. Freeze."
3. Display the image that is to be saved.
4. Select "S. Save image." The image that was displayed when "S. Save image" was selected will be frozen.
5. Enter the filename.

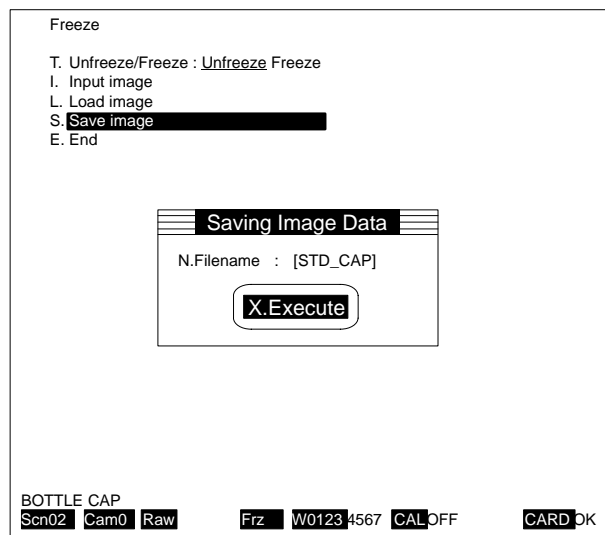

6. Select "X. Execute." A message will be displayed asking for confirmation.

7. Select "X. Execute." The frozen image will be saved to the memory card. The extension (.IMG) will be added automatically to the filename. After the save has been completed, a message will be displayed asking for confirmation.

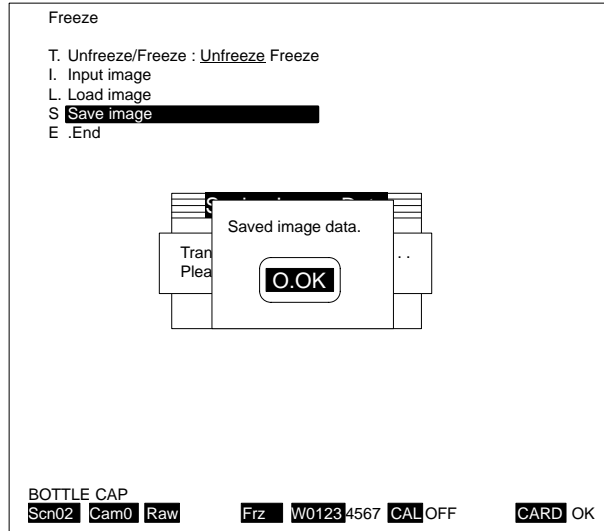

8. Select "O. OK."

Note There may be occasions where the amount of image data is more than can be saved to the memory card. The amount of image data will vary greatly depending on the image, so be sure to use a memory card with sufficient available space.

4-2-3 Displaying Windows

The user can select whether or not windows that have been drawn are to be displayed. The default setting is for all windows to be displayed, so if there are multiple overlapping windows the individual windows cannot be distinguished. If that should occur, the user can set the unneeded windows so that they will not be displayed. That can be helpful in cases such as the following:

Window for Position Displacement Compensation



Window for Measurement



When All Windows are Displayed

Even if the measurement is executed, the window for that measurement cannot be checked.



When Window for Position Displacement Compensation is Not Displayed

The window for that measurement can be checked.



Using Two Cameras

When two cameras are used, the selection as to whether windows are to be displayed can be made for each camera separately. Select the camera for which the setting is to be made. For instructions, refer to 4-3-1 *Selecting Cameras*.

- 1, 2, 3...**
1. Select "W. Window."
 2. Set to OFF the windows that are not to be displayed.

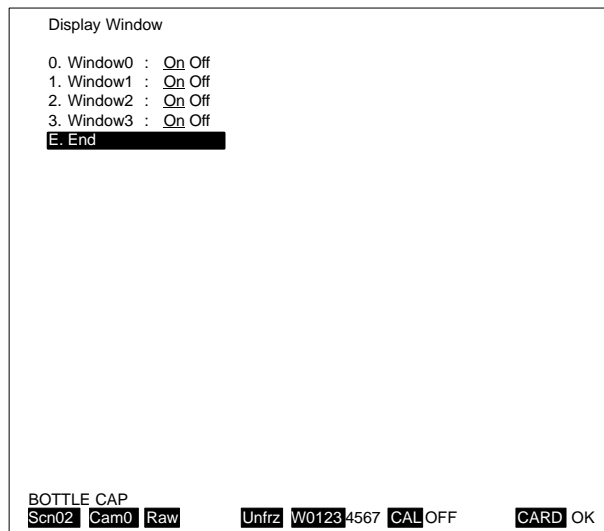

3. Select "E. End." The windows that are set to OFF will not be displayed.

4-3 Cameras

C. Camera

With “C. Camera,” the data can be set for creating the images for measurement. The operations accessed in the submenu shown below are explained on subsequent pages.

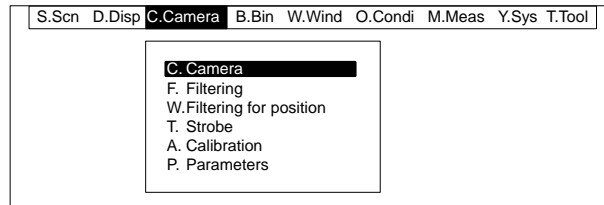

4-3-1 Selecting Cameras

When two cameras are used, the data from “C. Camera,” “B. Binary,” “W. Window,” and “O. Conditions” must be set for each camera. The first step is to select the number of the camera for which the data is to be set. If only one camera is used, then that is not necessary. Be sure, however, that camera 0 is connected.

- 1, 2, 3...**
1. Select “C. Camera.”
 2. Select the camera number. The images from the selected camera number will be displayed, and data can be set for that camera.

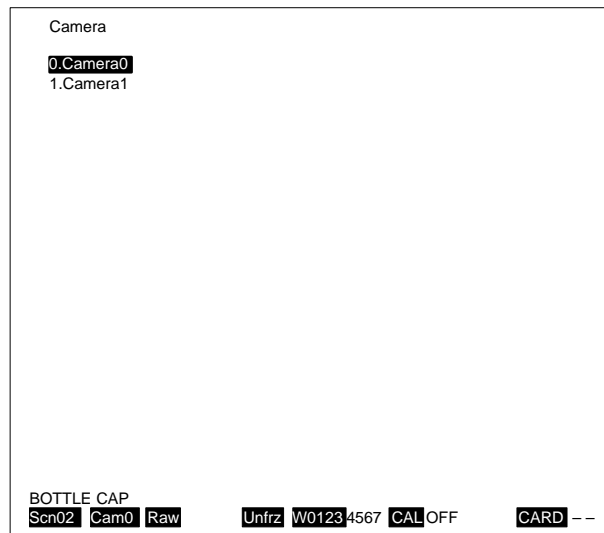

4-3-2 Selecting Filtering for Measurement

Images from the camera can be processed (filtered) and made easy to convert to binary. A binary image is created according to the binary level that is set for an image after filtering. Before setting the binary level, be sure to select “Filtering.”

When Position Displacement Compensation is Set

Different filtering can be selected for position displacement compensation or for measurement. For details, refer to *4-6-1 Setting Position Displacement Compensation* and *4-3-3 Selecting Filtering for Position Displacement Compensation*.

When Two Cameras are Used

Filtering can be selected separately for each camera. Select the number of the camera for which filtering is to be set. For details, refer to *4-3-1 Selecting Cameras*.

Using Filtered Images

The following photographs show the effects that the various types of filtering

have in comparison to the raw image from the camera (when filtering is set to OFF). Explanations are provided on how to use each type of filtering.

Filtering: OFF

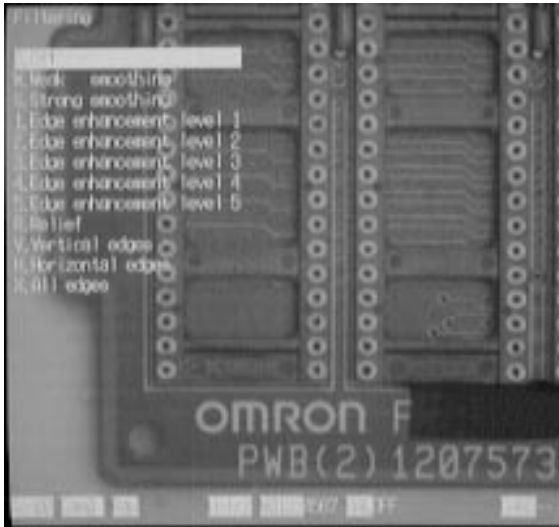

Filtering is not executed. The binary image can be created from the raw image.

Filtering: Smoothing

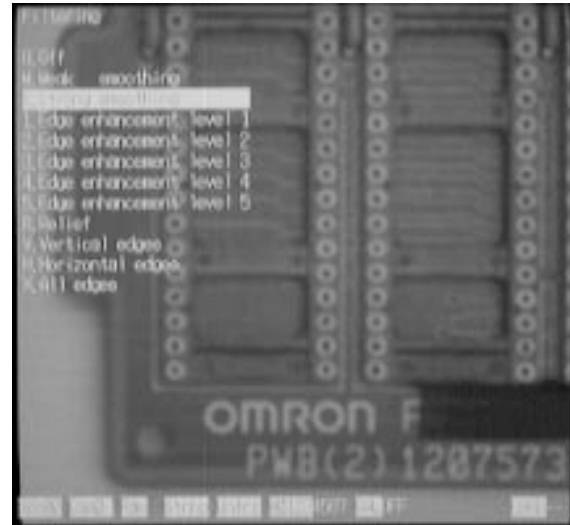

“Smoothing” can be used to create a smooth image with a minimum of noise. It helps to reduce the effects of uneven lighting due to factors such as scratched or irregular surfaces. The smoothing level can be set to either weak or strong.

Filtering: Edge Enhancement

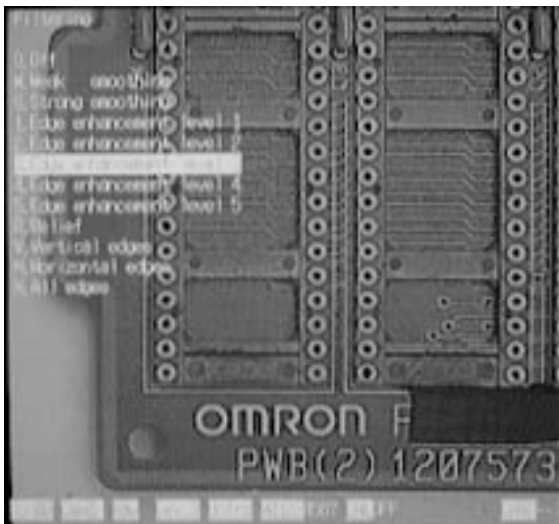

“Edge enhancement” sharpens the contrast between light and dark edges. This can be helpful in creating binary images when there is light fluctuation. There are five progressively stronger levels of edge enhancement.

Filtering: Relief

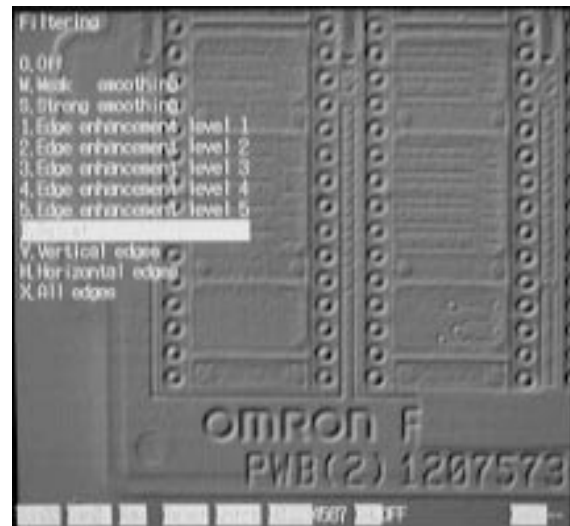

“Relief” creates images showing relief, and is helpful when measuring objects with surface irregularities.

Filtering: Vertical Edges

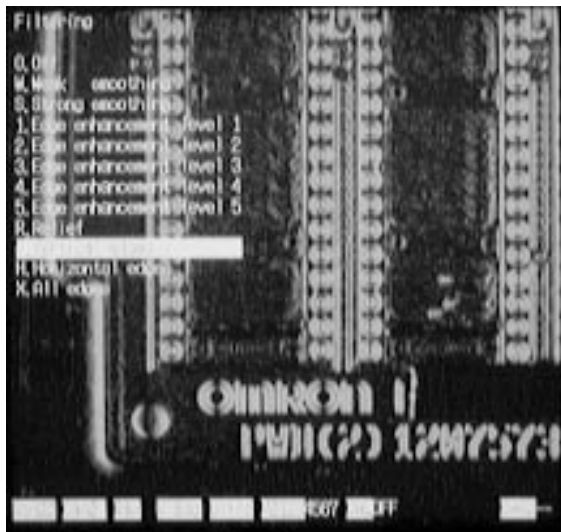

“Vertical edges” extracts the object’s vertical edges between light and dark only. It is helpful in creating binary images with irregularities enhanced in the vertical direction.

Filtering: Horizontal Edges

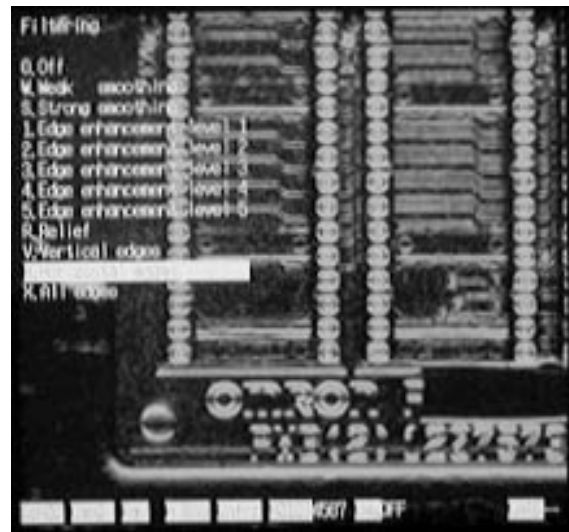

“Horizontal edges” extracts the object’s horizontal edges between light and dark only. It is helpful in creating binary images with irregularities enhanced in the horizontal direction.

Filtering: All Edges

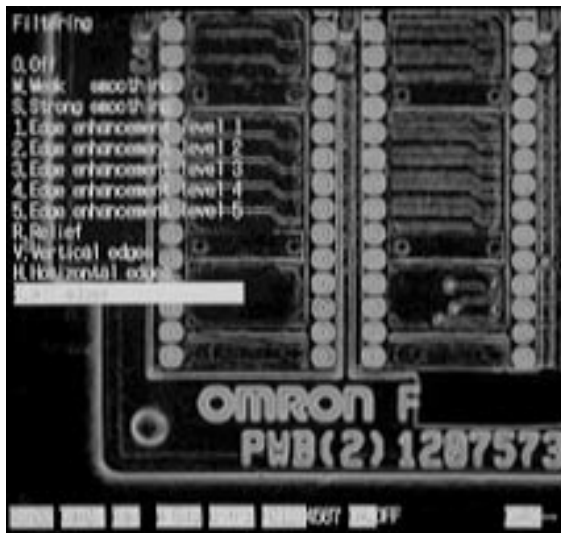

“All edges” extracts the object’s edges between light and dark only. It is helpful in creating binary images with irregularities enhanced.

Procedure

To select the filtering, follow the procedure outlined below.

- 1, 2, 3... 1. Select "F. Filtering." When the cursor is moved, the pre-treatment image at the cursor position will be displayed.

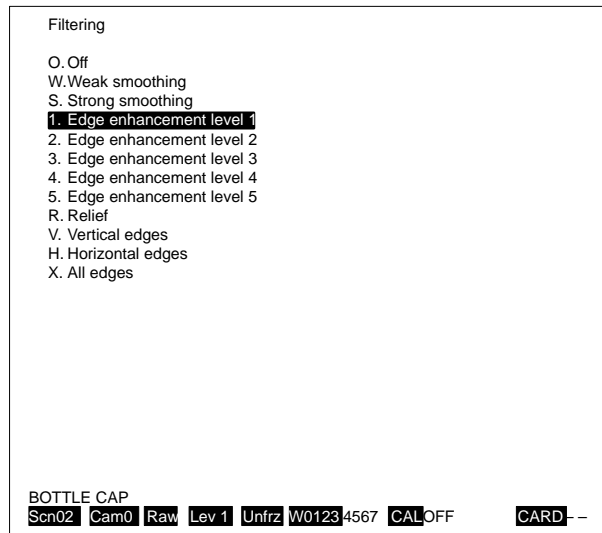

2. Select the type of filtering that is to be set.

4-3-3 Selecting Filtering for Position Displacement Compensation

This menu is displayed when setting position displacement compensation. Set the position displacement compensation before selecting the filtering. For details, refer to *4-6-1 Setting Position Displacement Compensation*.

When setting position displacement compensation, different filtering can be selected from that selected for measurement. Select the optimal filtering for converting the image to binary. If desired, "D. Same as measurement" can be selected to set the same filtering for position displacement compensation as was set for measurement.

The types of filtering and the ways of using them are the same as for measurement. For details, refer to *4-3-2 Selecting Filtering for Measurement*. The following photographs show examples of useful applications.

Filtering for Position Compensation

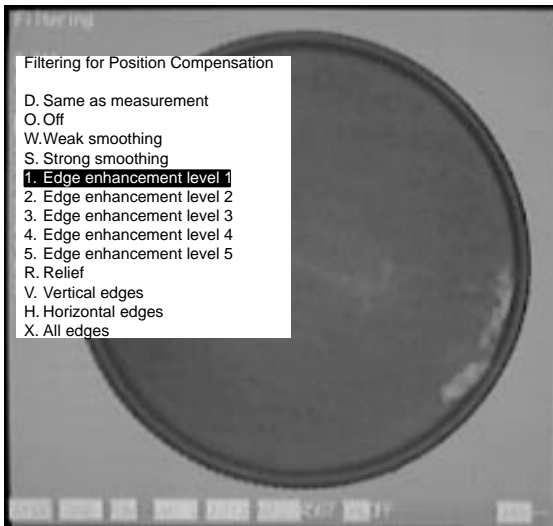

"Edge enhancement" is selected for position displacement compensation for the outer form of the workpiece.

Filtering for Measurement



"All edges" is selected to enhance the dirt in order to facilitate inspection for the presence of dirt.

When Two Cameras are Used

Filtering can be selected separately for each camera. Select the number of the camera for which filtering is to be set. For details, refer to 4-3-1 *Selecting Cameras*.

Procedure

To select the filtering, follow the procedure outlined below.

- 1, 2, 3...** 1. Select "W. Filtering for position." When the cursor is moved, the pre-treatment image at the cursor position will be displayed.

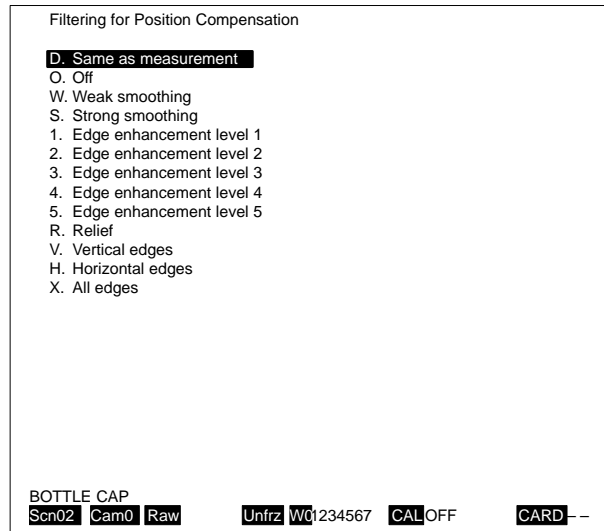

2. Select the type of filtering that is to be set.

4-3-4 Flashing the Strobe

If a Strobe I/F Unit is used, it must be specified which strobes are to flash. Up to four strobes can be connected for a single Strobe I/F Unit, and multiple strobes can be made to flash. The timing for strobes is as shown in the tables below.

When D. Display/F. Freeze is Set to "Unfreeze"

Operation	Strobe flash timing
Measurement screen	Strobes flash in synchronization with measurement commands.
Binary level setting screen	The strobe flash cycle can be set, and the strobes flash according to the set value.
Other screens	Strobes flash continuously.

When D. Display/F. Freeze is Set to “Freeze”

Operation	Strobe flash timing
Starting up	When the camera image is displayed.
D. Display/F. Freeze/I. Input image	When the Enter Key is pressed or a STEP signal is input.
C. Camera/C. Camera	When camera numbers are switched. Strobes do not flash, however, when the F300-A20S Normal Simultaneously Camera I/F Units or the F300-A20RS Shutter Simultaneously Camera I/F Units are used.
A. Calibration/S. Sampling/S. Settings/ A. Sampling	When “S. Save” is executed. (Note: For sampling screens, strobes flash continuously for unfrozen images to be displayed.)
O. Conditions/R. Reference image	When two cameras are used, strobes flash when the Enter Key is pressed or a STEP signal is input. They do not flash, however, when the F300-A20S Normal Simultaneously Camera I/F Units or the F300-A20RS Shutter Simultaneously Camera I/F Units are used.
M. Measurement/M. Measure	When measurement commands are input.
T. Tool/H. Histogram	When the area is designated. Strobes do not flash, however, when the F300-A20 Normal Camera I/F Unit is not used.
T. Tool/L. Line bright	When lines are designated. Strobes do not flash, however, when the F300-A20 Normal Camera I/F Unit is not used.
T. Tool/D. Density graph	When the Enter Key is pressed. Strobes do not flash, however, when the F300-A20 Normal Camera I/F Unit is not used.

Note If a strobe fails to flash during measurement, the error can be detected and output. For details, refer to *4-8-6 Selecting the Error Output Method*.

When Two Cameras are Used

Strobes can be set to flash separately for each camera. Select the number of the camera for which the strobe flash is to be set. For details, refer to *4-3-1 Selecting Cameras*.

Procedure

To set strobes, follow the procedure outlined below.

- 1, 2, 3... 1. Select “T. Strobe.”
2. Set to ON the strobes that are to flash.

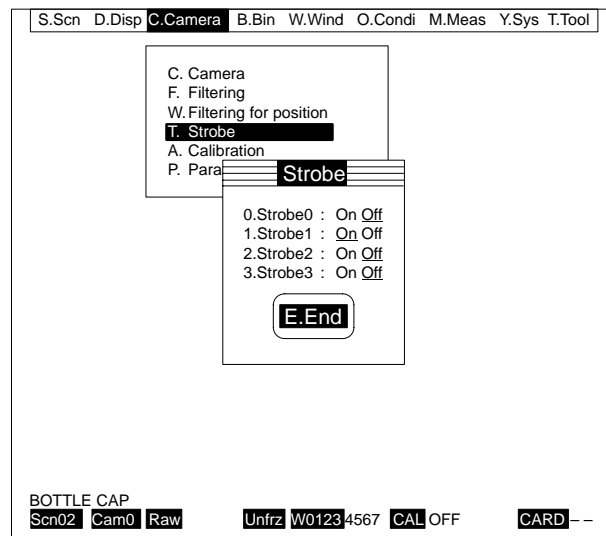

3. Select “E. End.”

4-3-5 Creating Data for Converting to Actual Dimensions

Measurement results are ordinarily output in pixel units, but it is possible to convert the pixels to the actual dimensions. The conversion operation is called “calibration.” This section explains how to set the data required for calibration. In order for data to be output as actual dimensions, “Calibration” must be set to ON. For further details, refer to *4-7-3 Outputting Measured Values in Actual Dimensions*.

When Two Cameras are Used

Calibration data can be set separately for each camera. Select the number of the camera for which the calibration data is to be set. For details, refer to 4-3-1 *Selecting Cameras*.

Calibration Methods

There are four ways of setting calibration data. These four ways, outlined on the following pages, involve "S. Sampling," "O. Coordinates," "C. Copy," and "N. Numeric" respectively.

Method 1: Inputting Actual Center-of-Gravity Coordinates (S. Sampling)

This method can be used when the center-of-gravity coordinates for a measurement image are already known. The calibration data is computed automatically when a sampling measurement of the image is taken and the center-of-gravity coordinates are input.

A) Selecting the Coordinate System

Before setting the calibration data, it is first necessary to select the coordinate system and the unit that are to be used.

1, 2, 3...

1. Select "A. Calibration."
2. Select "S. Sampling."
3. Select "C. Coordinate system."
4. Set the coordinate system and the unit.

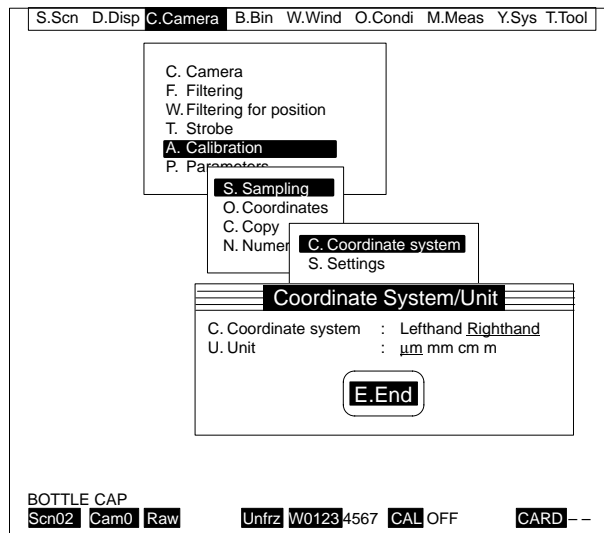

B) Setting the Calibration Data

Set the calibration data as shown in the flowchart below.

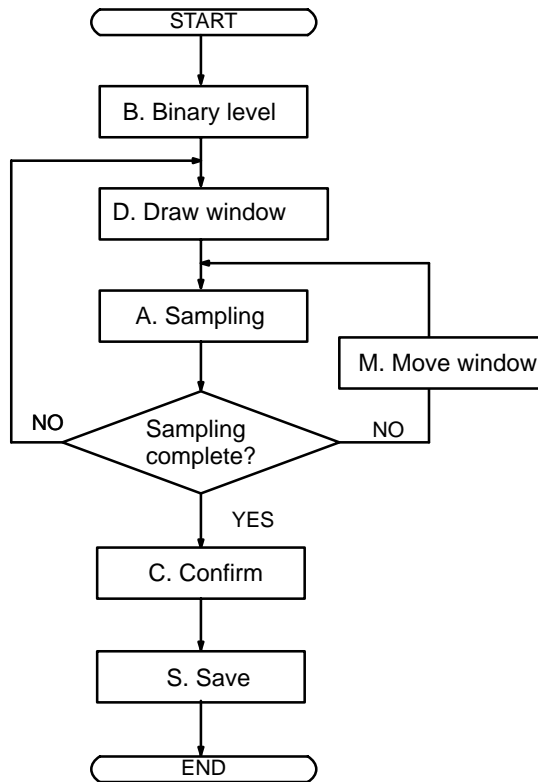

Procedure

Follow the procedure outlined below to set the calibration data by inputting the actual center-of-gravity coordinates.

- 1, 2, 3...** 1. Select "S. Settings." The calibration data settings screen will be displayed.

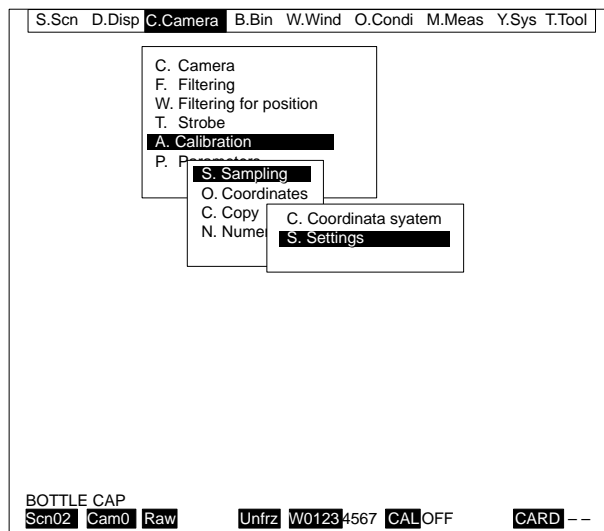

2. Select "B. Binary level." Set the binary level so that the workpiece on which the sampling measurement is to be carried out will be displayed as white pixels. The binary level set here is for purposes of sampling measurement only, and has no effect on scene data. For instructions on setting the binary level, refer to 4-4-2 *Setting the Binary Level*.

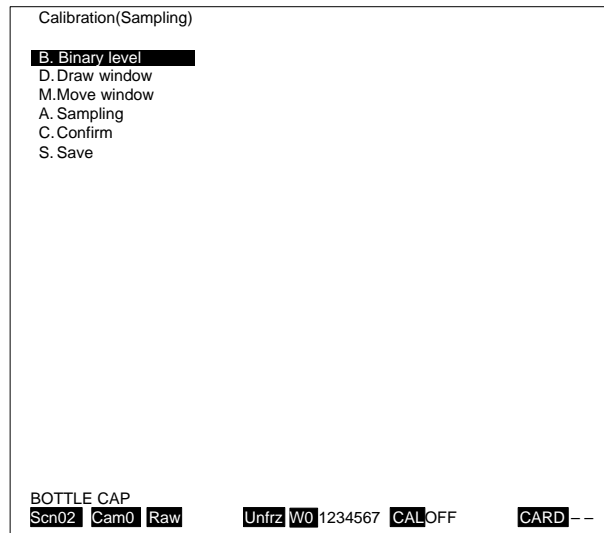

3. Select "D. Draw window." Draw a circular window (by setting the center and one point on the circumference) for the area for carrying out the sampling measurement.

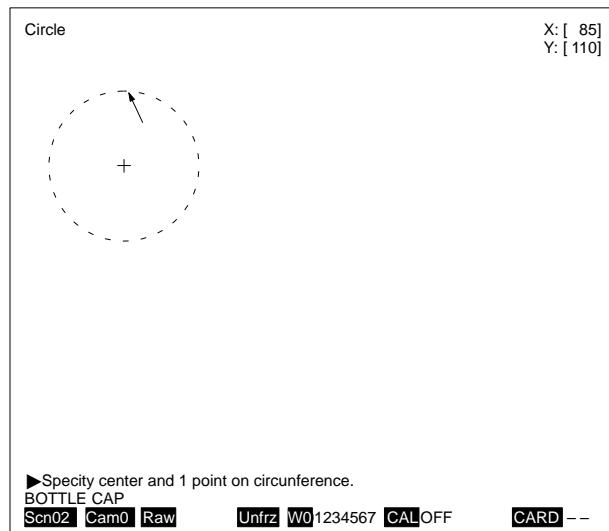

4. Select "A. Sampling." The sampling measurement screen will be displayed. When the Enter Key is pressed, the actual coordinates input screen will be displayed and a cross cursor will be displayed at the center of the window. Enter the actual coordinates.

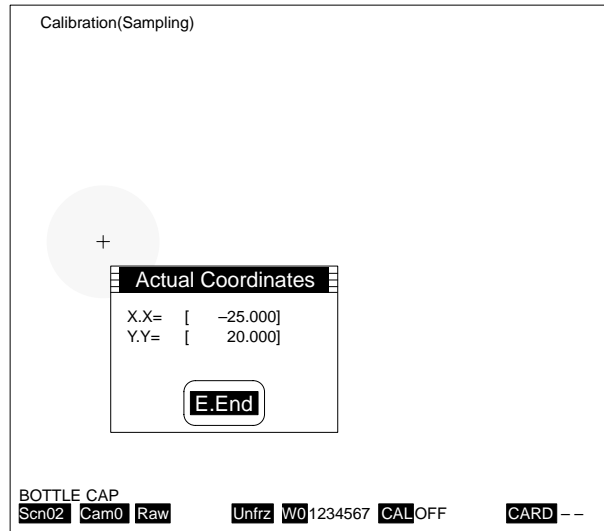

5. Select "M. Move window." In order to execute the next sampling measurement, the window must be moved. Move it to the position for carrying out the sampling measurement. To execute sampling measurement for two or more points, repeat the operations in steps 4 and 5. In addition, the binary level and window graphic can be changed with each sampling measurement. Repeat steps 2 through 5 as many times as required. (Sampling measurements can be executed for a maximum of 15 points. The more points that are sampled, the greater will be the accuracy of the calibration.)

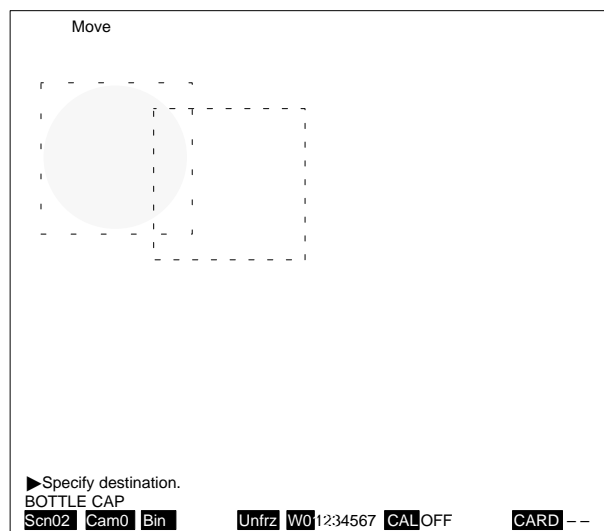

6. Select "C. Confirm." The calibration data that has been set, the scale and scale unit will be displayed on the screen.

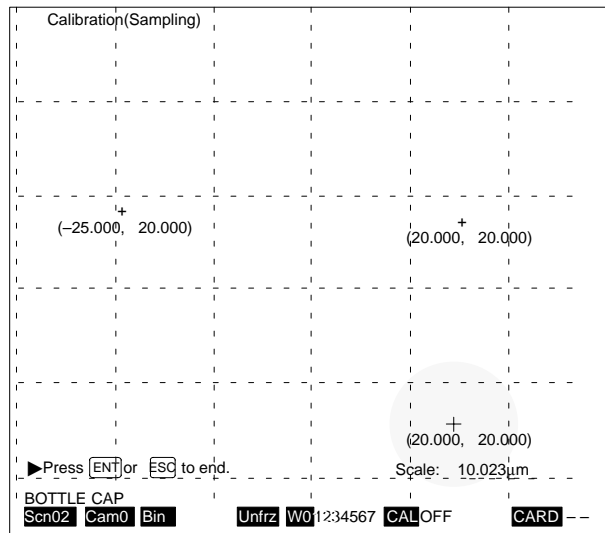

7. Select "S. Save." The calibration data that has been set will be saved.

Note The calibration data that is currently set can be checked by means of C. Camera/A. Calibration/N. Numeric.

Method 2: Inputting Coordinate Points (O. Coordinates)

This method can be used when the actual coordinates are already known. The calibration data is computed automatically when a point on the screen is designated and the actual coordinates are input.

A) Selecting the Coordinate System

Before setting the calibration data, it is first necessary to select the coordinate system and the unit that are to be used.

- 1, 2, 3... 1. Select "A. Calibration."
2. Select "O. Coordinates."
3. Select "C. Coordinate system."
4. Set the coordinate system and the unit.

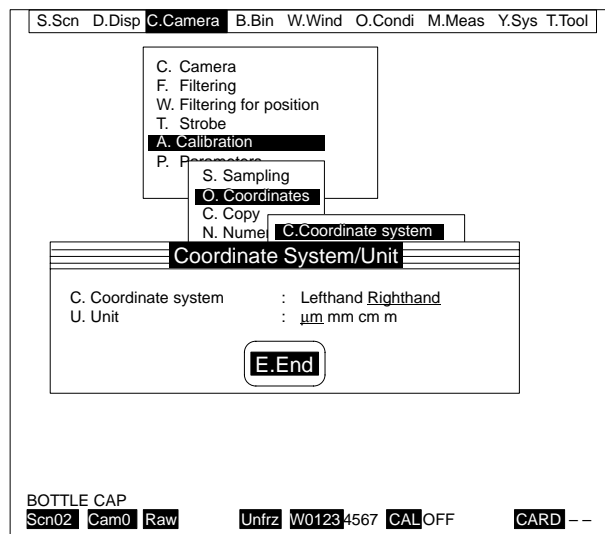

B) Setting the Calibration Data

Set the calibration data as shown in the flowchart below.

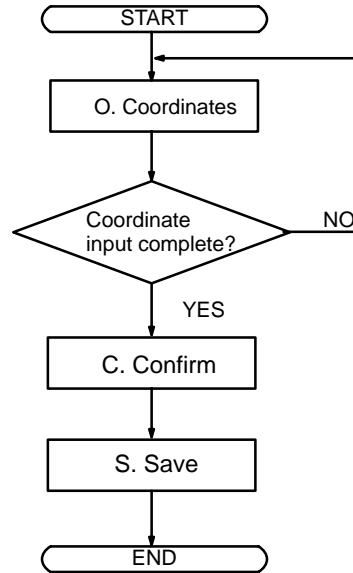
**Procedure**

Follow the procedure outlined below to set the calibration data by inputting the coordinate points.

- 1, 2, 3...** 1. Select "S. Settings." The calibration data settings screen will be displayed.



2. Select "O. Specifying coordinates." The raw image will be displayed at the coordinate point designation screen. The actual coordinates input screen will be displayed when the cursor is moved to the coordinate point input position and the Enter Key is pressed. Input the actual coordinates. Repeat this operation to enter two or more actual coordinate points. (Up to 15 actual coordinate points can be input. The more actual coordinates that are input, the greater will be the accuracy of the calibration.)

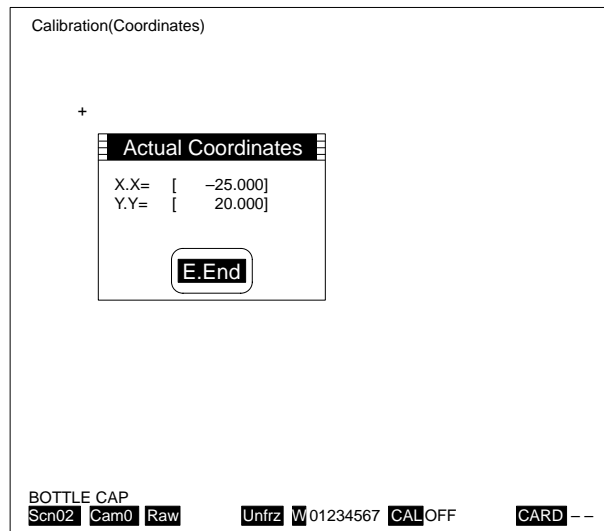

3. Select "C. Confirm." The calibration data that has been set, the scale and scale unit will be displayed on the screen.

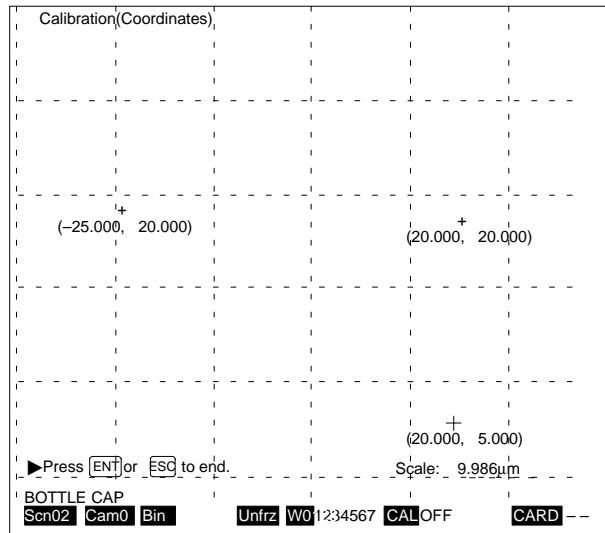

4. Select "S. Save." The calibration data that has been set will be saved.

Note The calibration data that is currently set can be checked by means of C. Camera/A. Calibration/N. Numeric.

Method 3: Copying Calibration Data (C. Copy)

Calibration data set for other scenes can be copied.

- 1, 2, 3... 1. Select "A. Calibration."
2. Select "C. Copy." The calibration data set for all other scenes will be displayed.

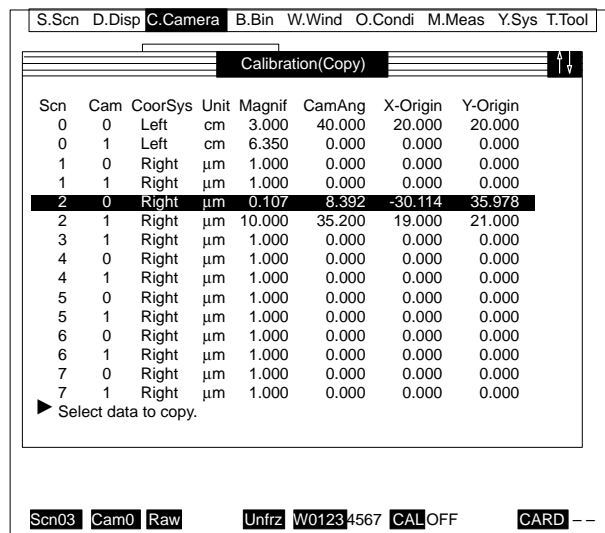

3. Select the data that is to be copied. First move the cursor to the desired position, and then press the Enter Key. The calibration data will be copied from the other scene and set as data for the present scene.

WARNING Be sure to check the contents of the calibration data before copying it to the scene. The existing calibration data will be overwritten.

Method 4: Entering Numbers (N. Numeric)

Calibration data can be entered by direct numeric input. Before being input, the calibration data must be computed in advance.

- 1, 2, 3... 1. Select "A. Calibration."
2. Select "N. Numeric." The calibration data input screen will be displayed.

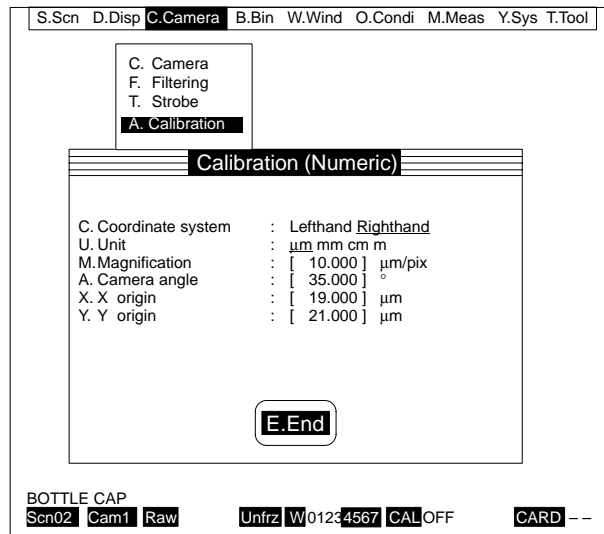

3. Set the data within the ranges shown in the following table.

Operation	Range
M. Magnification	0.000 to 2,999.999
A. Camera angle	-179.999 to 180.000
X. X origin	-2,999,999.999 to 2,999,999.999
Y. Y origin	-2,999,999.999 to 2,999,999.999

4-3-6 Checking Data Set by C. Camera

The data set by "C. Camera" can be displayed for each camera and the contents of the set data relating to that camera can be checked. The data can only be checked, however, and not changed.

The screenshot shows a software interface with a menu bar at the top: S.Scen D.Disp **C.Camera** B.Bin W.Wind O.Condi M.Meas Y.Sys T.Tool. A dropdown menu is open under 'C.Camera', listing: C. Camera, F. Filtering, W.Filtering for position, T. Strobe, A. Calibration, and **P. Parameters**. The 'Parameters' window is open, showing a table of parameters:

	Filter	Posi(Fil)	Strobe	Calib
Camera0 :	A Edg	On(Lev1)	0	0.107μm/pix
Camera1 :	Lev3	Off(off)	Off	10.000μm/pix

Below the table is an 'O.OK' button. At the bottom of the interface, there is a status bar with the following information: BOTTLE CAP, Scn02, Cam0, Raw, Unfrz, W0123, 4567, CAL OFF, CARD --. Callouts from the text on the right point to these elements:

- The strobes that are to flash are displayed here. (Points to the 'Strobe' column in the table)
- The magnification for the calibration data is displayed here. (Points to the 'Calib' column in the table)
- Filtering for position displacement compensation is displayed. (Points to 'W0123' in the status bar)
- Position displacement compensation is set to ON or OFF. (Points to 'CAL OFF' in the status bar)
- Filtering for measurement is displayed. (Points to 'Raw' in the status bar)

- 1, 2, 3...**
1. Select "P. Parameters."
 2. Select "O. OK."

4-4 Binary

B. Binary

With the F200, the white pixels of binary images are counted to find the area, center of gravity, and axis angle. In order to create the optimal binary images, it is necessary to set the upper and lower limits for the binary level. The binary level can be set separately for each window number, so binary images can be created according to the window applications. The operations accessed in the submenu shown below are explained on subsequent pages.

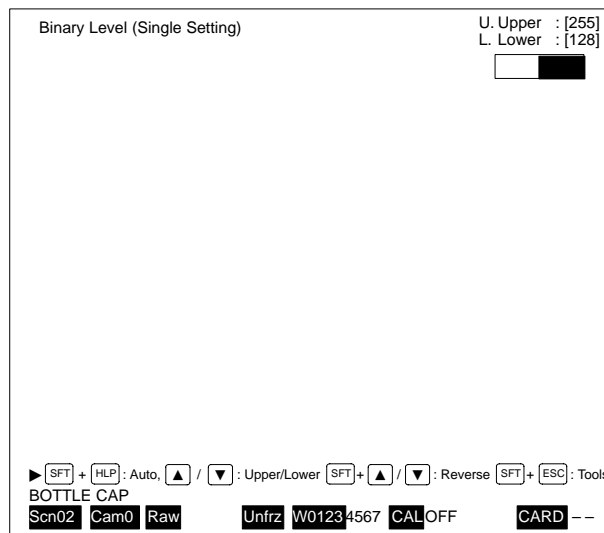
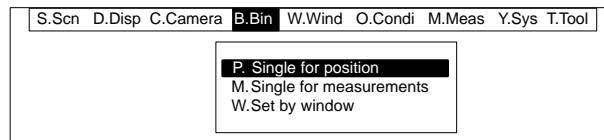
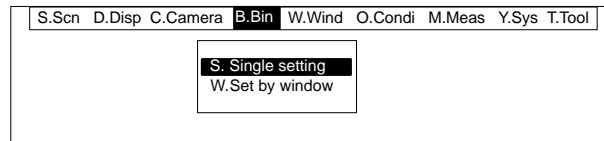

Preliminary Operations

Before setting the binary level, first select the filtering. If filtering is executed first, a more stable binary image can be created. For details, refer to *4-3-2 Selecting Filtering for Measurement* and *4-3-3 Selecting Filtering for Position Displacement Compensation*.

When Two Cameras are Used

The window numbers that can be set are determined separately for each camera. The binary level can be set for windows with respect to the camera that is currently displayed. Before setting the binary level, select the number of the camera for which the binary level is to be set. For details, refer to *4-3-1 Selecting Cameras*.

4-4-1 Selecting the Binary Level Setting Method

There are two methods for setting the binary level. The first is to set the same binary level for all of the windows simultaneously, and the second is to set different binary levels for individual windows. Be careful about using the first method, as it will change the binary levels for all windows including those that have already been set individually.

Setting the Same Binary Level for All Windows

When different filtering is set for position displacement compensation and for measurement, the binary level for all of the respective windows can be set simultaneously.

- 1, 2, 3... 1. To set the same binary level for all windows, select "S. Single setting." The binary level setting screen will be displayed.

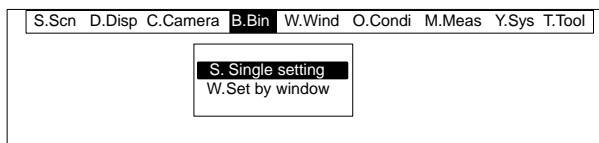

2. If the filtering settings for position displacement compensation and for measurement are different, then the menu will appear as follows:

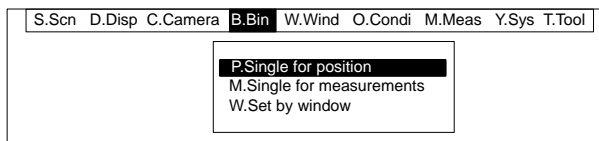

Setting Different Binary Levels for Windows

Use this method when the brightness of the area to be measured is different for each window.

- 1, 2, 3... 1. Select "W. Set by window." The window numbers and their respective uses will be displayed. For details, refer to 4-6-1 *Setting Position Displacement Compensation* and 4-6-3 *Setting the Output Expression*.

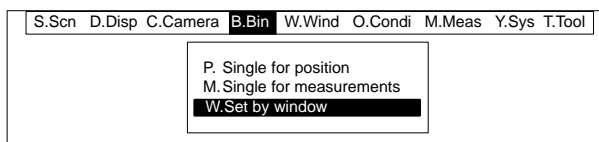

2. Select the window number. The binary level setting screen for the selected window number will be displayed.

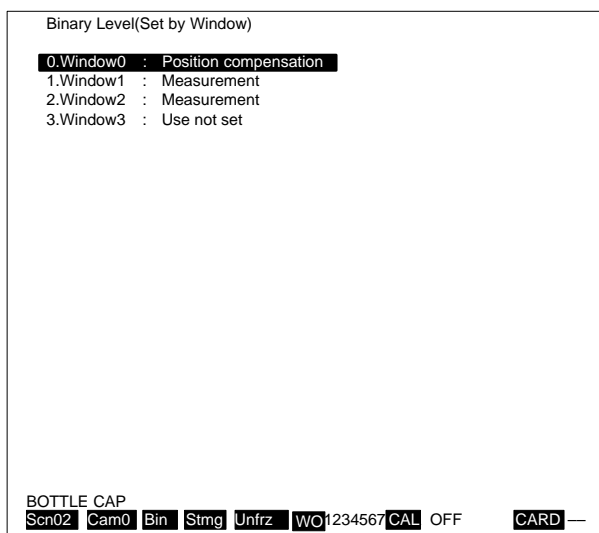

4-4-2 Setting the Binary Level

Set the binary level so that the region that is to be measured will be displayed as white pixels. The default values for the binary level are 255 (upper limit) and 128 (lower limit). Set the optimal upper and lower limits while observing the binary image. The normal method is to just input the numbers for the upper and lower limits. It is also possible to make the settings while observing a histogram or line brightness. In addition, when strobes are used, the interval between flashes can be set at the binary level setting screen.

Normal Method

The normal method for setting the upper and lower limits is to input the numbers while observing the binary image.

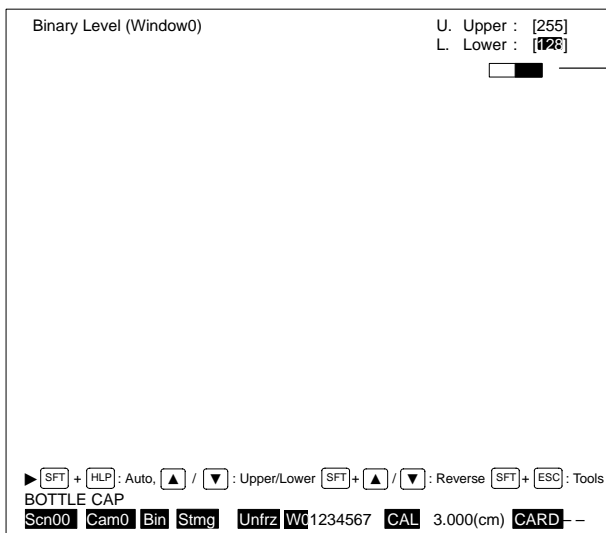

Binary level setting contents displayed.

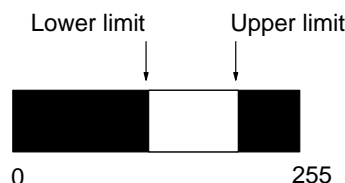

Key input	Operation
Up/Down Keys	Selects the upper and lower limits.
Right/Left Keys	Changes the number.
Shift Key+ Enter Key	Automatically sets the optimal lower limit for the light/dark boundary. The upper limit is fixed at 255. Use this to set the binary level when the boundary between light and dark is clear.
Shift Key + Up/Down Keys	Reverses the white pixels.

- 1, 2, 3...**
1. Set the optimal upper and lower limits while observing the binary image. The binary image may change depending on the light source and the lens status. Make the necessary adjustments to secure the optimal conditions.
 2. Press the Enter Key. The binary level will then be set.

Histogram

The upper and lower limits can also be set while observing a histogram of the image that is currently being displayed. The upper and lower limits can be set by means of the cursor position on the histogram. For information on histograms, refer to 4-9-1 Histograms.

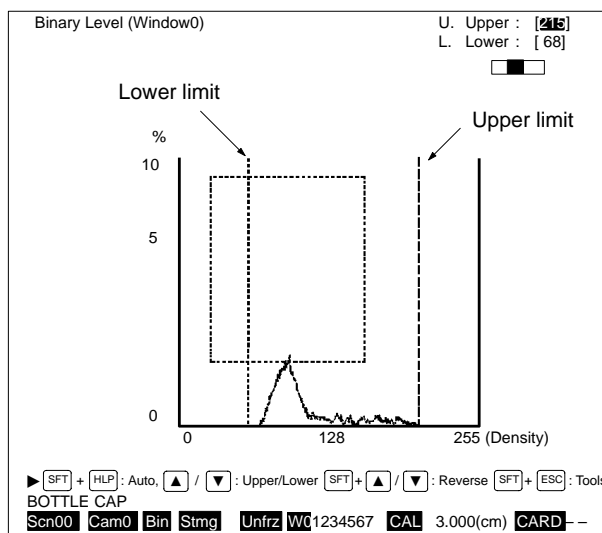

- 1, 2, 3...**
1. Press the Shift and Escape Keys. The auxiliary tool menu will be displayed.

2. Select "H. Histogram."
3. Designate the area where the histogram is to be displayed by specifying the opposite corners of a rectangle and pressing the Enter Key. The histogram will then be displayed.

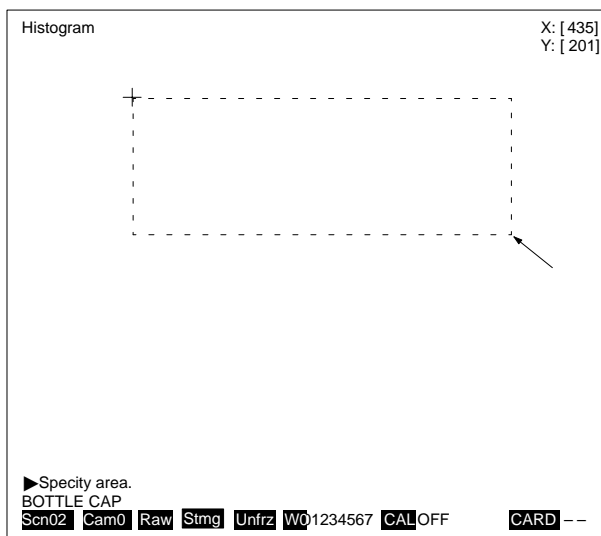

4. Set the upper and lower limits. A cursor will be displayed on the histogram to indicate the upper and lower limits. Use the histogram as a reference for making the settings.
5. Press the Enter Key.

Line Brightness

Line brightness displays as a graph the brightness levels along any X or Y axis on the screen. The upper and lower limits can also be set while observing the line brightness diagram of the image that is currently being displayed. The upper and lower limits can be set by means of the cursor position on the line brightness diagram. For information on line brightness, refer to 4-9-2 *Line Brightness*.

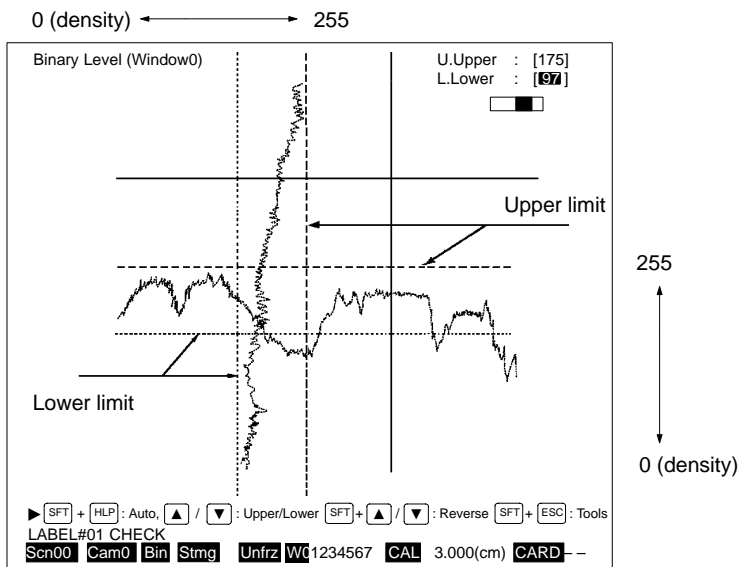

- 1, 2, 3... 1. Press the Shift and Escape Keys. The auxiliary tool menu will be displayed.
2. Select "L. Line bright."

- Designate the lines to be displayed for line brightness. Use the direction keys to move the lines and then press the Enter Key. The line brightness will be displayed.

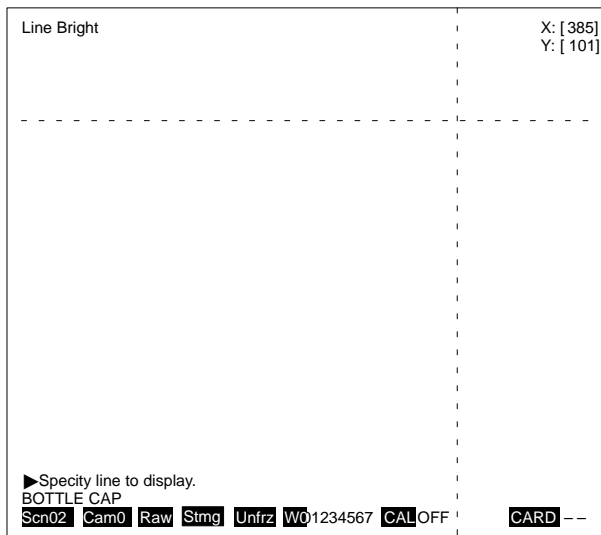

- Moving the cursor on the line brightness diagram, set the upper and lower limits. Use the line brightness as a reference for making the settings.
- Press the Enter Key.

When Strobes are Used

When an image is measured using strobes, the strobe flash interval can be set with the binary level setting screen. The range varies slightly according to the camera that is connected, as shown below.

Camera	Range
F200-S	1 to 999 (x 16.7 ms)
F300-S	2 to 999 (x 16.7 ms)

The default setting is for the smallest possible interval for the camera that is connected.

- 1, 2, 3... 1. Press the Shift and Escape Keys. The auxiliary tool menu will be displayed.
2. Select "T. Strobe."

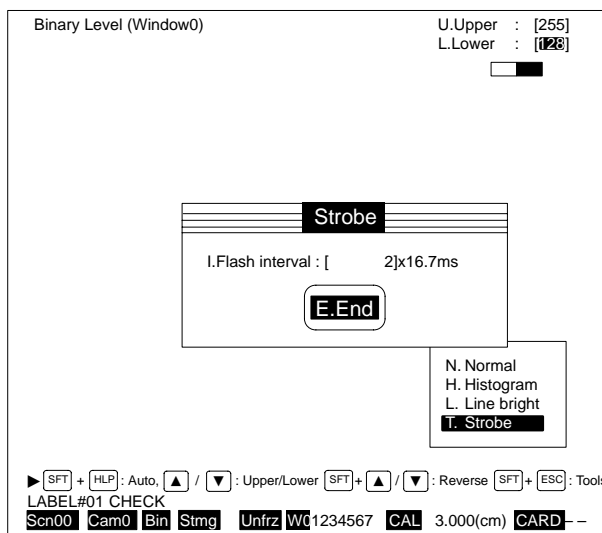

3. Set the flash interval.

4-5 Windows

W. Window

The region for measuring the area, center of gravity, and axis angle is called a window. Draw a window graphic for the place that is to be measured. Up to four windows can be set per camera, and four places can be measured per image. When positioning displacement compensation is used, the area for measuring the amount of position displacement is also drawn as a window.

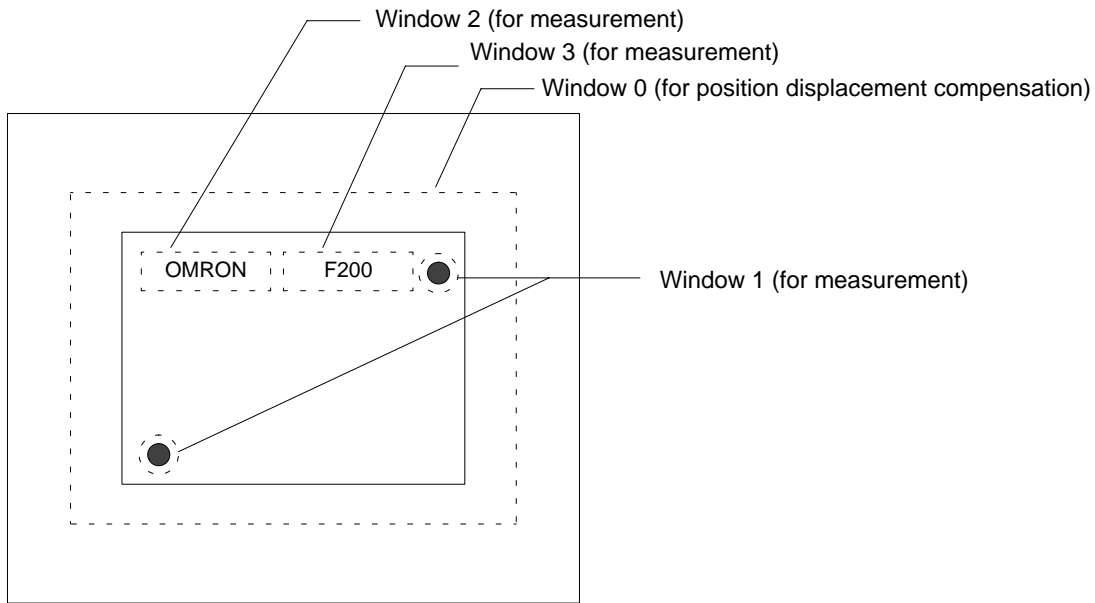

Use “W. Window” to draw window graphics suitable for the application, and to set window functions for each Window. The operations accessed in the submenu shown below are explained on subsequent pages.

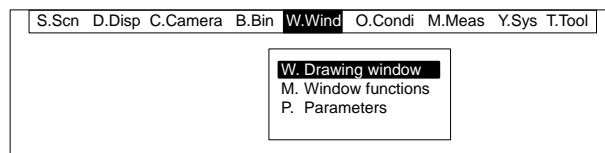

4-5-1 Drawing Windows

Window graphics can be drawn for the areas to be measured for each window plane. With the F200, a maximum total of 255 graphics can be drawn. Window graphics can be drawn by combining graphics.

Drawing Modes

There are three modes for drawing windows: Draw (OR), Mask (NOT), and Reverse (XOR). To create a graphic, first select “Draw.” The window graphic will depend on the drawing modes and the order in which it is drawn. The three types of drawing modes are described in the following table.

Drawing Modes

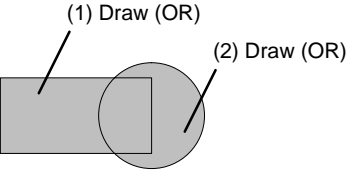
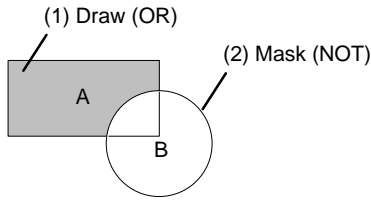
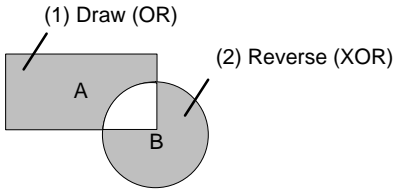
Mode	Function	
O. Draw (OR)		<p>Use Draw (OR) for drawing window graphics. The area inside the drawn graphics will be set as windows. Even if multiple windows are drawn in a single window plane, they will still be measured as a single window.</p>
M. Mask (NOT)		<p>Use Mask (NOT) for deleting a portion of the window graphic.</p> <p>If graphic B is drawn in Mask (NOT) mode after graphic A has already been drawn, the corner of graphic A will be cut as shown in the illustration.</p> <p>If graphic A is drawn after graphic B has already been drawn, graphic B will be ignored and the entirety of graphic A will be taken as the window.</p>
R. Reverse (XOR)		<p>Use Reverse (XOR) for deleting the overlapping portion of a window graphic.</p> <p>If graphic B is drawn in Reverse (XOR) mode so as to overlap graphic A, the overlapping portion will be cut (i.e., excluded from the objects to be measured).</p> <p>If graphic A is drawn after graphic B, nothing will be cut and the entirety of graphic A will be taken as the window.</p>

Example: Drawing a Ring-shaped Window

- 1, 2, 3...**
1. Set the circle drawing method to "Center/circumference."
 2. Set the drawing mode to "Draw (OR)" and draw the outer circle.

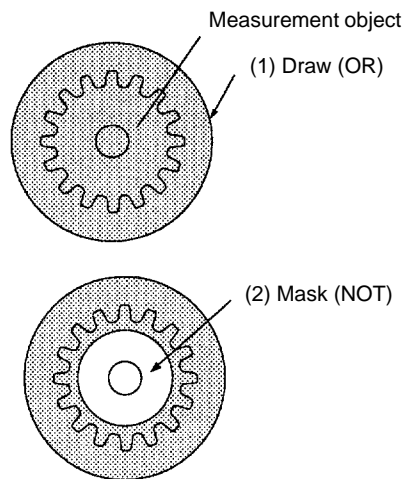

3. Set the drawing mode to "Mask (NOT)" and draw the inner circle.

Graphic Types and Drawing Methods

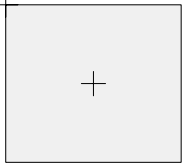
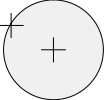
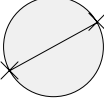
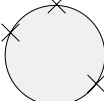
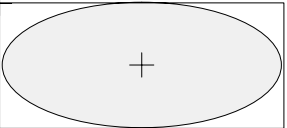
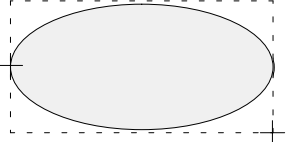
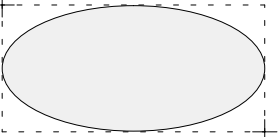
Graphic	Item	Drawing method
B. Box	Two opposing corners (initial value)	Specify two opposing corners. 
	Center/one corner	Specify the center position for the box, and then specify any corner. 
C. Circle	Center/circumference (initial value)	Specify the center position for the circle, and then specify any point on the circumference. 
	Two diameter points	Specify both ends of the diameter. 
	Three circumference points	Specify any three points on the circumference. 
A. Arc	Center/external point (initial value)	Specify the center position, and then specify any corner of the external box that circumscribes the arc. 
	End point/external point	Specify either the left or right end point for the arc, and then specify any corner of the external box that circumscribes the arc. 
	External box	Specify opposing corners of the external box that circumscribes the arc. 

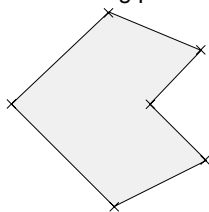
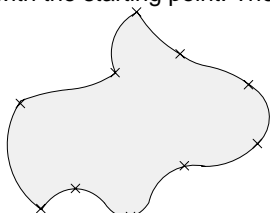
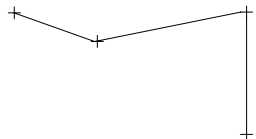
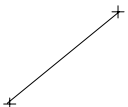
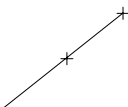
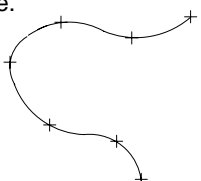
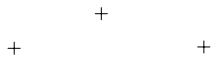
Graphic	Item	Drawing method
P. Polygon		Specify the order of points (within 30 points). After specifying the end point, press the Enter Key twice to connect the end point with the starting point. The graphic will then be complete. 
V. Curved area		Specify the order of points (within 30 points). After specifying the end point, press the Enter Key twice to connect the end point with the starting point. The graphic will then be complete. 
L. Line	Continuous line (initial value)	Specify the order of points (within 30 points). After specifying the end point, press the Enter Key twice. The graphic will then be complete. 
	Two end points	Specify any two points. 
	Center/end point	Specify the center, and then specify either end point. 
U. Curved line		Specify the order of points (within 30 points). After specifying the end point, press the Enter Key twice. The graphic will then be complete. 
O. Point	Continuous points (initial value)	 Continuously designate within 30 points. After specifying the end point, press the Enter Key twice. The graphic will then be complete.
	Single point	Draw only a single-point window consisting of one pixel.
T. Object (See note.)		Specify the graphic to be drawn as a window graphic from a binary image. Draw the window graphic from the white pixels of the binary image. Size it before setting it as a window.

Note Use "T. Object" as illustrated in the following examples.

Example 1: Drawing a Graphic Without a Hole

- 1, 2, 3...**
1. Set the binary level so that the part to be created as a window is displayed as white pixels.
 2. With "T. Object," select "Draw (OR)" mode.
 3. Select the white-pixel graphic. The selected graphic will be displayed. It can be sized by means of the Up and Down Keys.
 4. Press the Enter Key. The window graphic will be drawn.

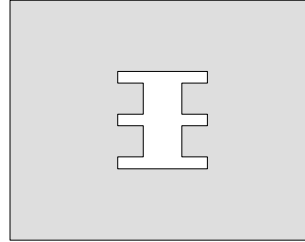
**Example 2: Drawing a Graphic With a Hole**

- 1, 2, 3...**
1. Set the binary level so that the part to be created as a window is displayed as white pixels.
 2. With "T. Object," select "Draw (OR)" mode.
 3. Select the white-pixel graphic (1). The window graphic will be displayed with the hole filled in.
 4. Press the Enter Key.
 5. With "T. Object," select "Draw (OR)" mode.
 6. Select the black-pixel graphic (2). The message "Specified graphic will be registered as hole graphic. Confirm?" will be displayed.
 7. Press the Enter Key. The window graphic with a hole will be drawn.

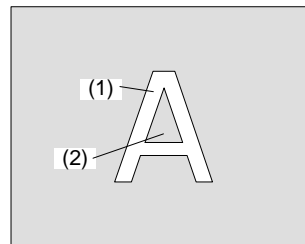
**When Two Cameras are Used**

Windows can be set with respect to the camera that is currently displayed. Before setting the windows, select the number of the camera for which the windows are to be set. For details, refer to *4-3-1 Selecting Cameras*.

- 1, 2, 3...**
1. Select "W. Drawing window." The window numbers and their respective uses will be displayed. For details, refer to *4-6-1 Setting Position Displacement Compensation* and *4-6-3 Setting the Output Expression*.

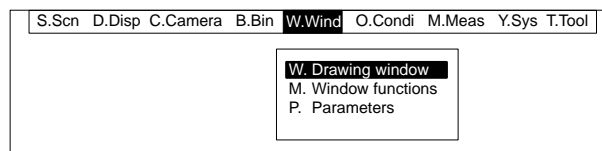

2. Select the window number.

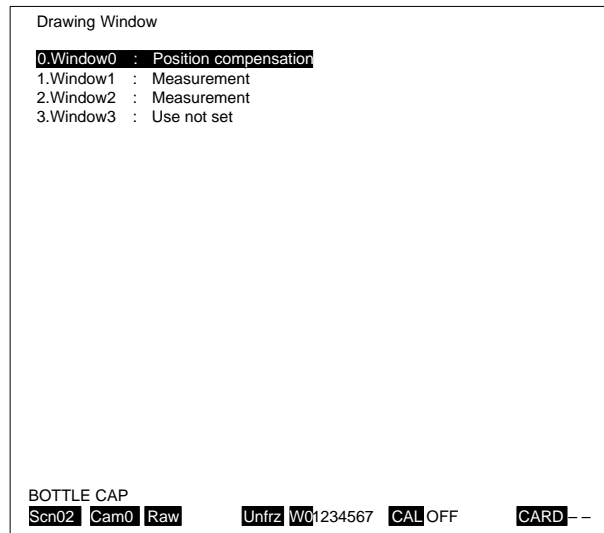

Note Window graphics drawn for different window planes (i.e., different window numbers) can be displayed. Press the Shift and Escape keys. If "O. Reference plane" is set to ON, the graphics for the different window planes will all blink.

3. Select the graphic.

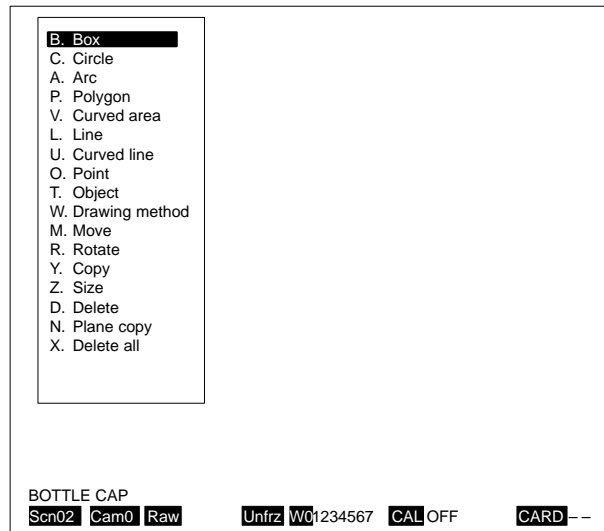

4. Select the drawing mode.

5. Draw the graphic. If a window is to be created by combining several graphics, repeat steps 3 through 5.

6. Press the Escape Key. The window drawing operation will be complete.

Editing Windows

Once a window has been created, it can be edited in any of seven ways. Whichever function is used, it is necessary first to specify the graphic that is to be

edited. The key operations for specifying the graphic are described in the following table.

Up/Down Keys	Change among the graphics. A graphic is designated by pressing the Enter Key. Multiple graphics can be designated. A solid-line frame is displayed for the designated graphic. The graphic designation is completed by pressing the Enter Key twice consecutively.
Shift Key + Enter Key	Specifies all of the graphics in the window.
Escape Key	Returns to the previous operation.

Editing Functions

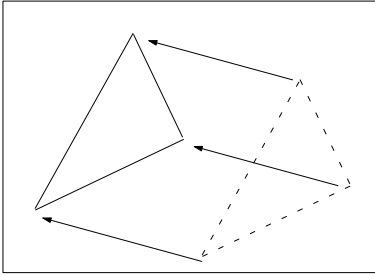
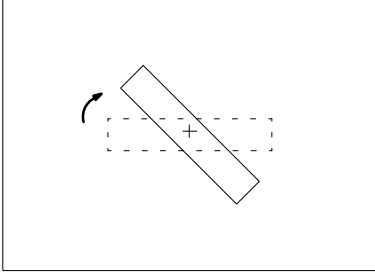
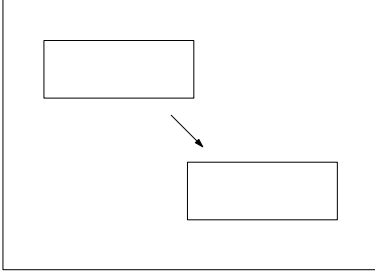
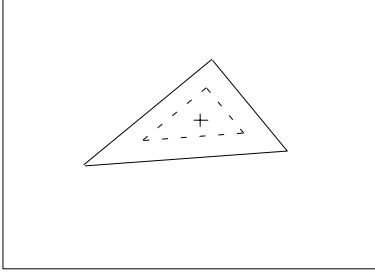
Item	Function
M. Move	 <p>Moves the designated graphic in a parallel direction. First specify the graphic, and then specify the destination.</p>
R. Rotate	 <p>Rotates the designated graphic. First specify the graphic, and then specify the direction of rotation. Windows created from arcs or by object generation cannot be rotated.</p>
Y. Copy	 <p>Copies the designated graphic. First specify the graphic, and then specify the copy destination.</p>
Z. Size	 <p>Takes the center position of the designated graphic as the base, and sizes the window. Windows created by object generation cannot be sized, nor can single point. In addition, the line width of straight or curved lines cannot be changed.</p>
D. Delete	Deletes designated graphics.
N. Plane copy	Copies graphics from a different window plane. Select the window number of the copy source. Then, when "Plane copy" is executed, the graphics from the specified window plane will all be copied and added.
X. Delete all	Deletes all the graphics in the window.

4-5-2 Selecting Window Functions for Measurement

Special measurement functions can be designated for each window. Any of the following three types of function can be used as required.

Fill Measurement

Everything within the contours of white-pixel objects in a window will be measured as white pixels. Use this function when measuring the shapes of the objects.

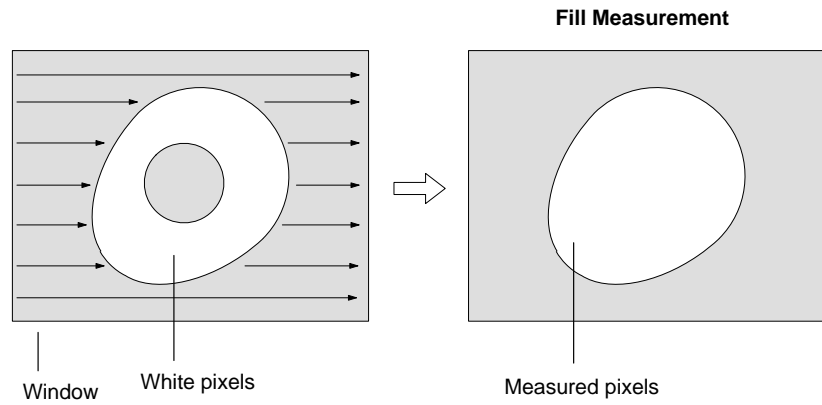

When irregular objects are measured, however, the measurement results will change according to the direction.

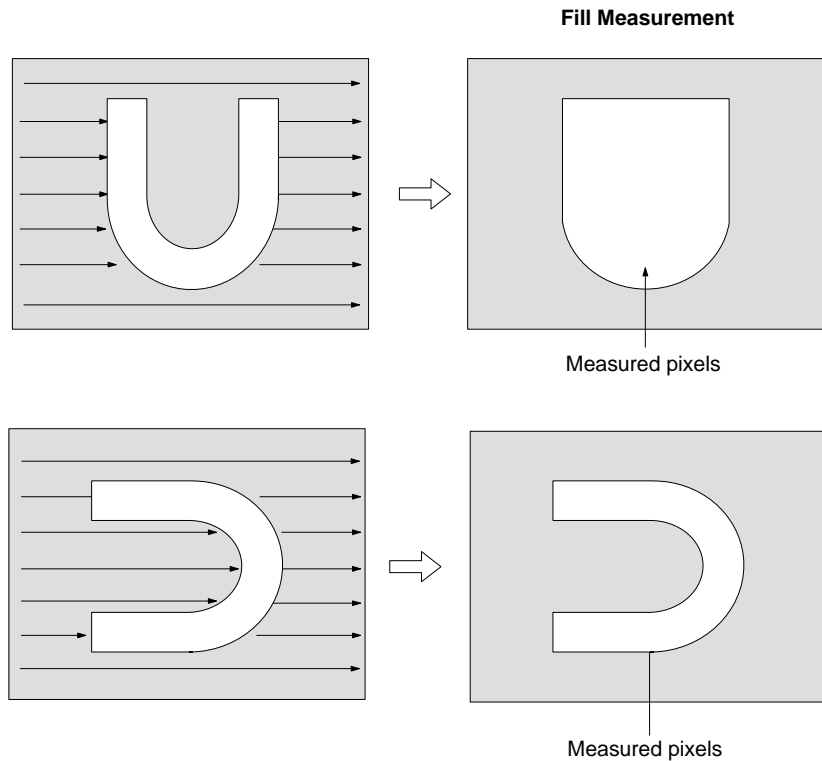

Paint

Any area can be measured as white pixels. Use this function when it is desired that a part of an object always be measured as white pixels. Window plane 3 (when camera 0 is used) and window plane 7 (when camera 1 is used) are called "paint windows." Windows created in those window planes will be regarded as consisting of all white pixels for measurement. Therefore, the paint function cannot be set for either of those windows.

The paint window and while pixels in the window will be measured.

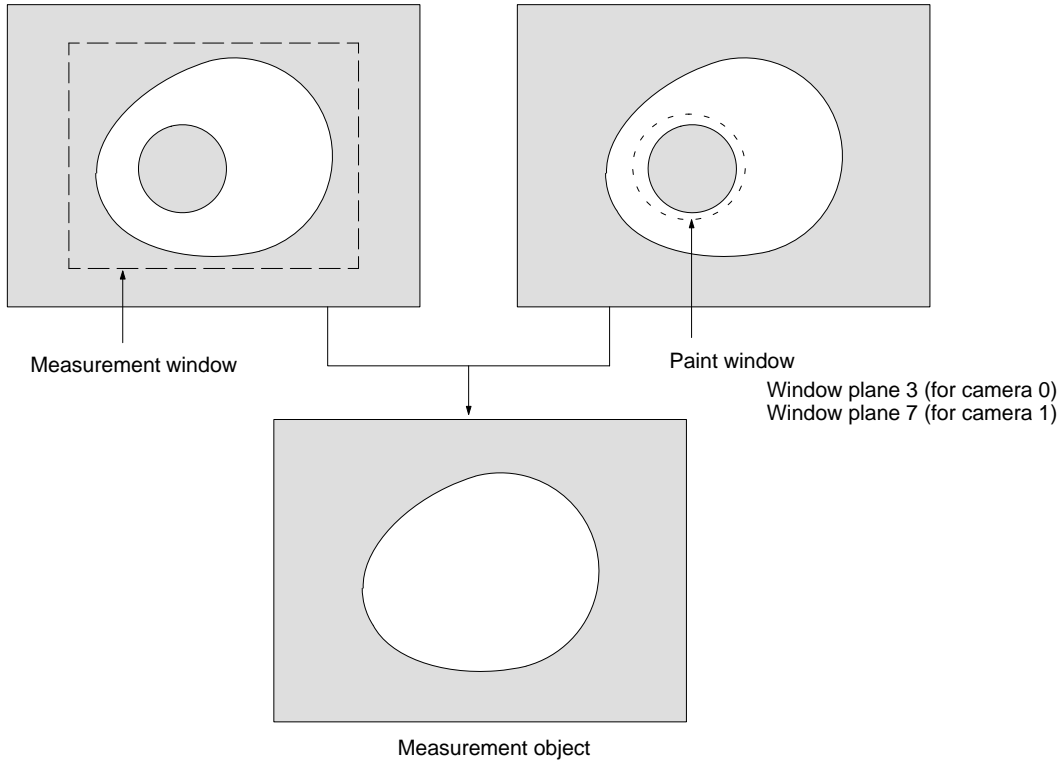

Pattern Matching

This function compares a window to a standard pattern and measures the white pixels that do not match. Window plane 3 (when camera 0 is used) and window plane 7 (when camera 1 is used) are used for the standard pattern areas, and they are called "pattern matching windows." Therefore, the pattern matching function cannot be set for either of those windows.

The window is compared to a standard pattern created in either window plane 3 or window plane 7, and the white pixels that do not match are measured.

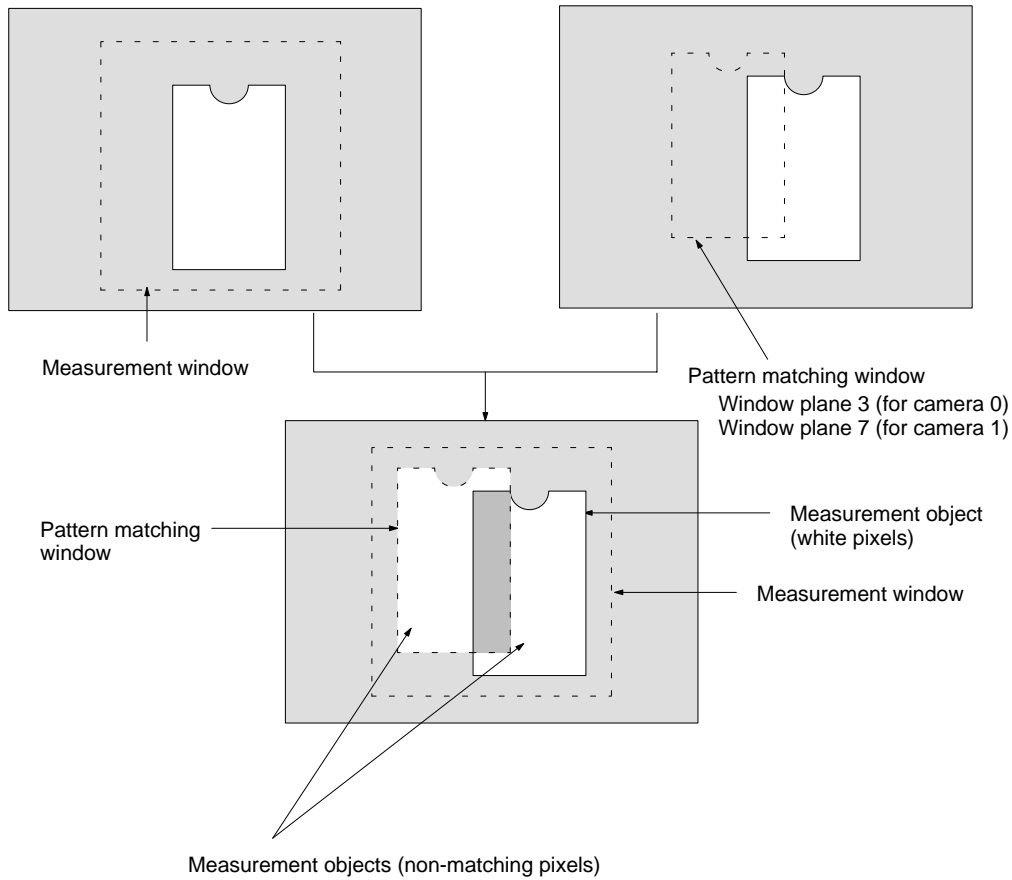

When Two Cameras are Used

Window functions can be set with respect to the camera that is currently displayed. Before setting the functions, select the number of the camera for which the functions are to be set. For details, refer to 4-3-1 *Selecting Cameras*.

- 1, 2, 3... 1. Select "M. Window functions."

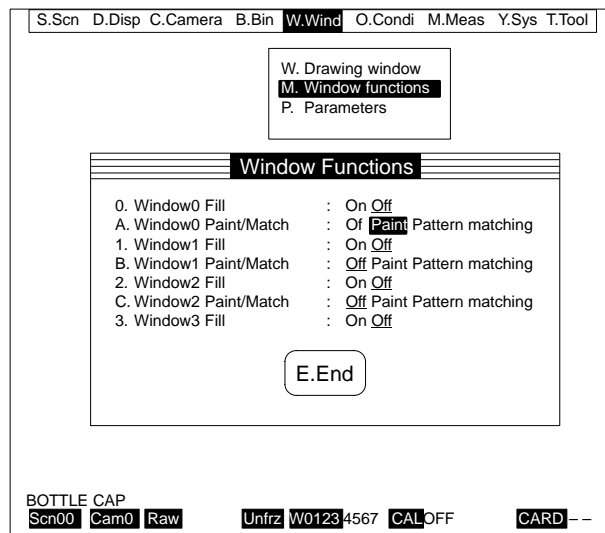

2. Set the window function for each window.

4-5-3 Checking Data Set by W. Window

The data set by “W. Window” can be displayed and checked by means of the procedure outlined below.

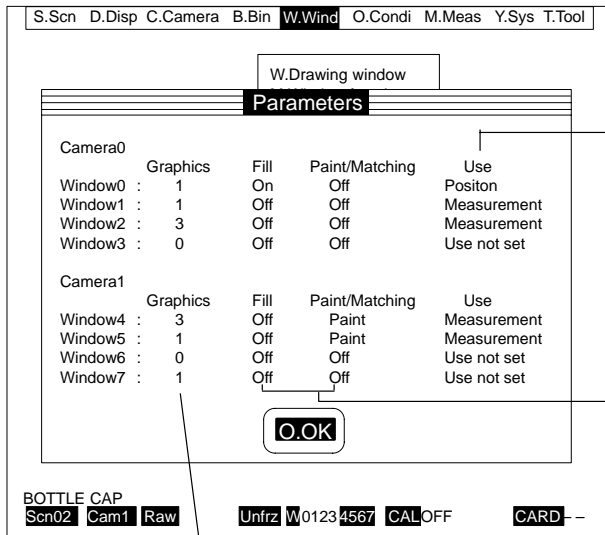

The window uses already set are displayed here.

Measurement	When set for output expression.
Position	When set for position displacement compensation window.
Use not set	When neither of the above is set.

The contents of the window function settings are displayed here.

The number of graphics drawn is displayed here. The maximum total number of graphics is 255.

- 1, 2, 3...
1. Select “P. Parameters.” The data will be displayed.
2. Select “O. OK.”

4-6 Conditions

O. Conditions

Data related to measurement conditions and position displacement compensation is set under the “O. Conditions” menu. The operations accessed in the submenus shown below are explained on subsequent pages.

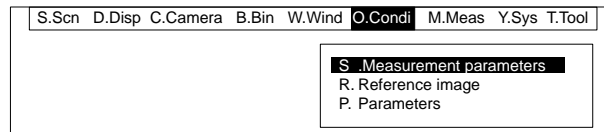

4-6-1 Setting Position Displacement Compensation

Position displacement compensation can be used in situations where there is variation in the positioning of measurement objects and measurement cannot be accurately carried out with measurement windows in fixed positions. When position displacement compensation is used, the amount of displacement of the position of the measurement object from a pre-registered reference position is computed, and the measurement window is moved automatically. This allows the targeted place to be measured consistently and correctly even if there is some variation in the positions of the measurement objects.

In order for position displacement compensation to function accurately, there are some related settings that must be made. Some of them have been covered earlier in this section. For information on drawing windows for position displacement compensation, refer to 4-5-1 *Drawing Windows*. For information on filtering for position displacement compensation, refer to 4-3-3 *Selecting Filtering for Position Displacement Compensation*. For information on setting the binary level for position displacement compensation, refer to 4-4-1 *Selecting the Binary*

Level Setting Method and 4-4-2 Setting the Binary Level. For information on registering the reference position for position displacement compensation, refer to 4-6-5 Saving Reference Images.

Compensation Modes

There are two methods, or modes, for position displacement compensation. These two modes, "Normal" and "Two windows," are described below.

A) Normal

"Normal" compensation computes the amount of position displacement of the center of gravity coordinates (X, Y) and the main axis angle from the reference position, and compensates for that amount of position displacement. Individual window can be specified for measuring the center of gravity coordinates (X, Y) and the angle of the main axis.

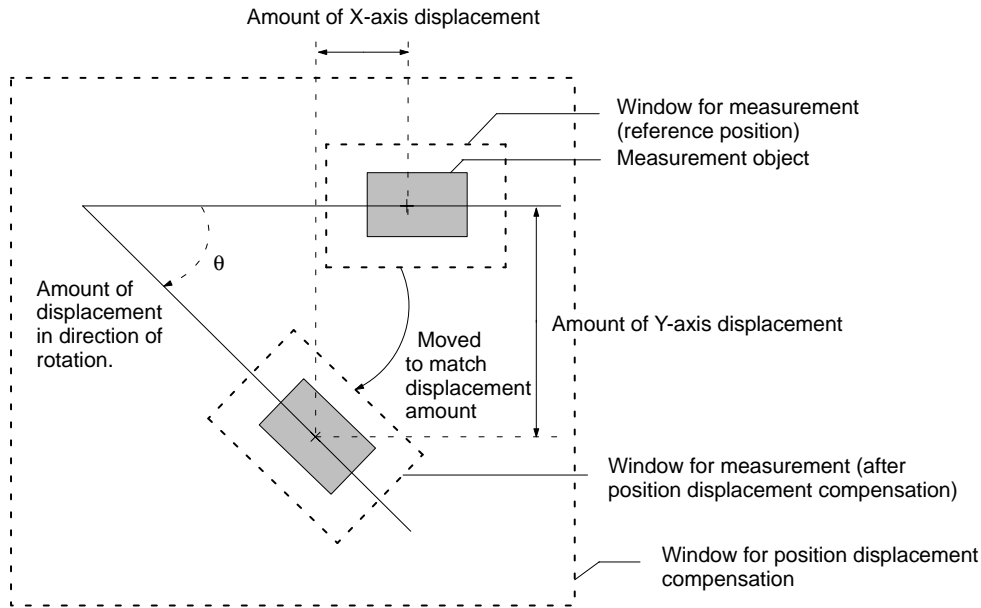

When Two Cameras are Used

Position displacement compensation can be set with respect to the camera that is currently displayed. Before setting position displacement compensation, select the number of the camera for which the compensation to be set. For details, refer to 4-3-1 Selecting Cameras.

- 1, 2, 3... 1. Select "S. Measurement parameters."
2. Set "P. Position compensation" to "Normal."

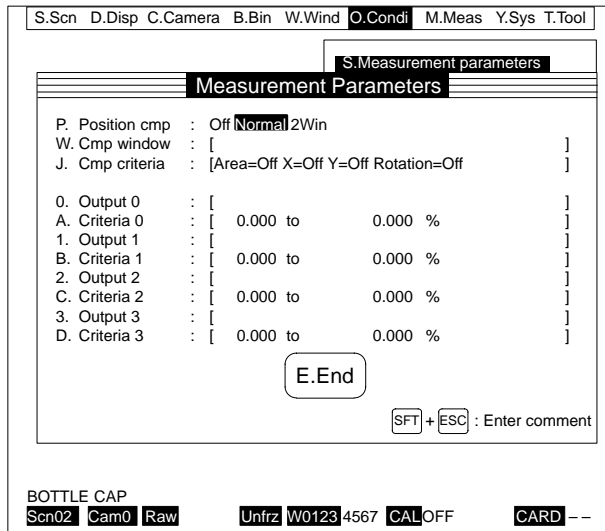

3. Select "W. Compensation window." Select the window to be used for measuring position displacement compensation. The window at the cursor position will be displayed as a solid-line frame.

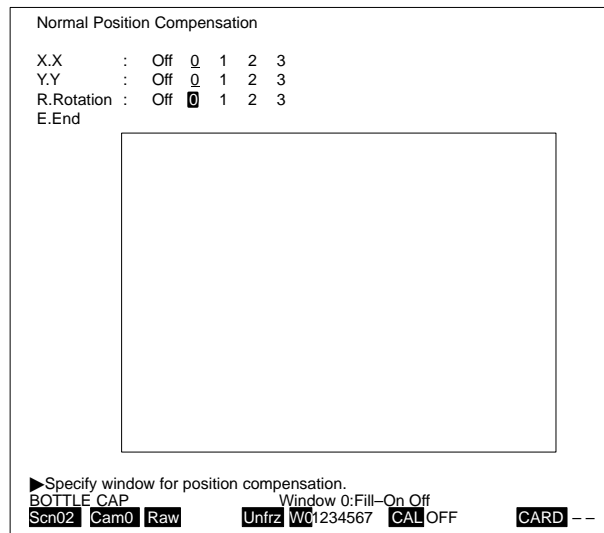

4. Select "E. End." The contents of the settings will be displayed on the screen.

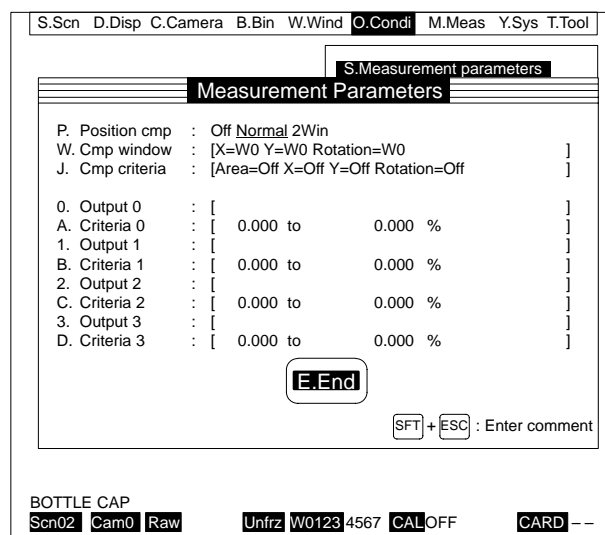

B) Two Windows

“Two windows” compensation uses two windows to measure the amount of position displacement of the mid-point coordinates and the inclination from the reference position, and compensates for that amount of position displacement. As shown in the illustrations below, the amount of displacement of the mid-point coordinates in the X and Y directions, and the amount of displacement in the direction of rotation for the inclination are measured.

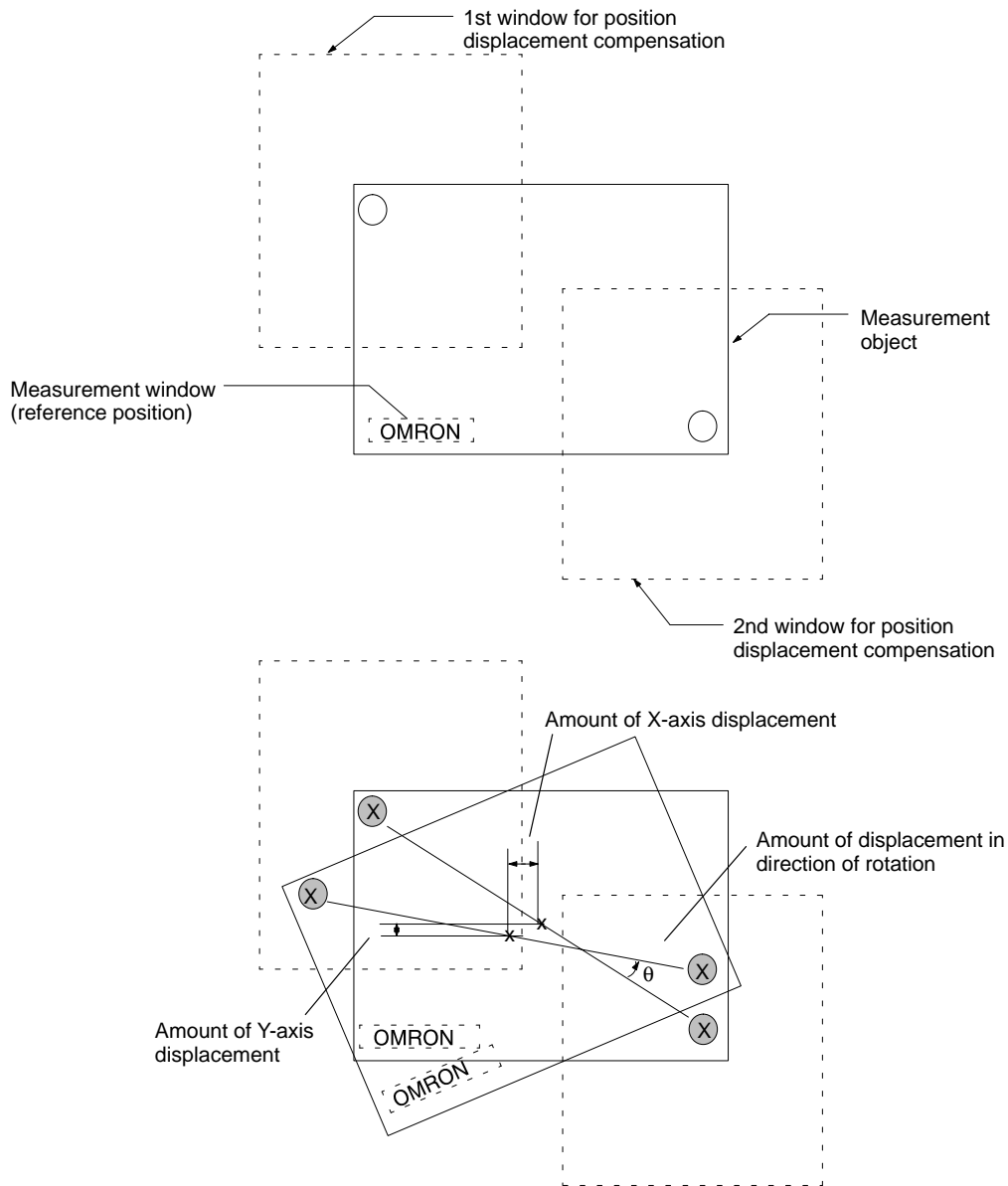

When Two Cameras are Used

Position displacement compensation can be set with respect to the camera that is currently displayed. Before setting position displacement compensation, select the number of the camera for which the compensation to be set. For details, refer to 4-3-1 *Selecting Cameras*.

- 1, 2, 3...** 1. Select “S. Measurement parameters.”

2. Set "P. Position compensation" to "2 Windows."

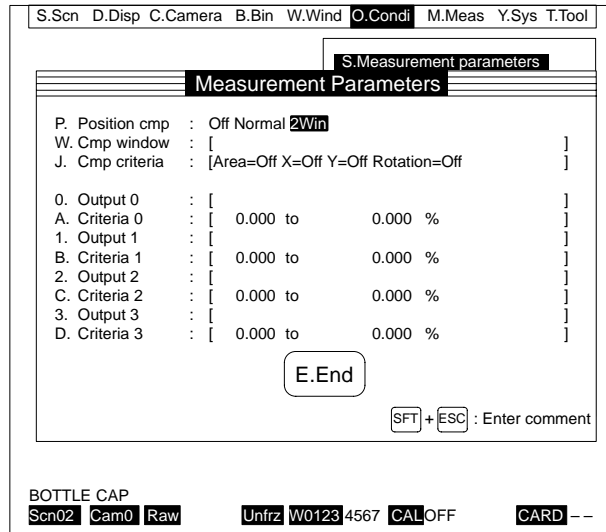

3. Select "W. Compensation window." Select the window to be used for measuring position displacement compensation. The window at the cursor position will be displayed as a solid-line frame.

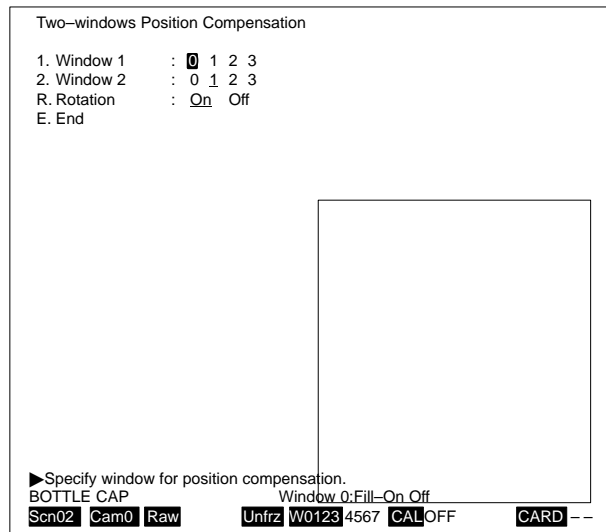

4. Select "E. End." The contents of the settings will be displayed on the screen.

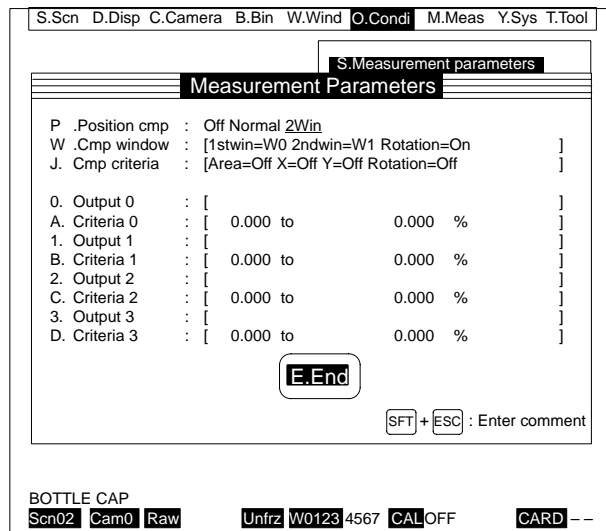

4-6-2 Setting Criteria for Judging Displacement

The measurement results from a window for position displacement compensation can be judged as either OK or NG. The judgement can be made separately for each camera, with the result output as an error. For details, refer to 4-8-6 *Selecting the Error Output Method*.

If the judgement concerning the amount of position displacement is NG, then the measurement result for that camera must also be NG. For details, refer to 4-6-5 *Saving Reference Images*.

The items for which the results can be judged are shown in the following tables. Multiple items can be set, but in that case the judgement will be NG if the result from any of the items is NG.

Compensation Mode: Normal

A. Area	Judges the area inside the window for measuring the amount of displacement in the X, Y, and rotation directions. If these are all set for different windows, the judgements are made for the respective windows. The acceptable range for a judgement of "OK" is set as a percentage of the area (100%) at the reference position.
X. X cmp	Judges the amount of center-of-gravity X-coordinate displacement in the window for measuring the amount of displacement in the X direction. The acceptable range for a judgement of "OK" is set in pixels, in reference to the reference position.
Y. Y cmp	Judges the amount of center-of-gravity Y-coordinate displacement in the window for measuring the amount of displacement in the Y direction. The acceptable range for a judgement of "OK" is set in pixels, in reference to the reference position.
T. Rotation cmp	Judges the amount of main axis angle displacement in the window for measuring the amount of displacement in the main axis angle. The acceptable range for a judgement of "OK" is set in degrees (°), in reference to the reference position.

Compensation Mode: Two Windows

A. Area	Judges the area inside the first and second windows. The judgements are made for the respective windows. The acceptable range for a judgement of "OK" is set as a percentage of the area (100%) at the reference position.
X. X cmp	Judges the amount of X-coordinate displacement from the mid-points of the first and second windows. The acceptable range for a judgement of "OK" is set in pixels, in reference to the reference position.
Y. Y cmp	Judges the amount of Y-coordinate displacement from the mid-points of the first and second windows. The acceptable range for a judgement of "OK" is set in pixels, in reference to the reference position.
T. Rotation cmp	Judges the amount of angle displacement from the inclination between the centers of the first and second windows. The acceptable range for a judgement of "OK" is set in degrees (°), in reference to the reference position.

Note The initial (default) value for the judgement's upper and lower limits is "0." If the judgement is set to ON without setting the upper and lower limits, the judgement will be taken as "0."

When Two Cameras are Used

The amount of position displacement can be judged separately for each camera. Before setting the criteria, select the number of the camera for which the criteria is to be set. For details, refer to 4-3-1 *Selecting Cameras*.

- 1, 2, 3...** 1. Select "S. Measurement parameters."

- Set "J. Compensation criteria." Set the criteria for judging the amount of position displacement.

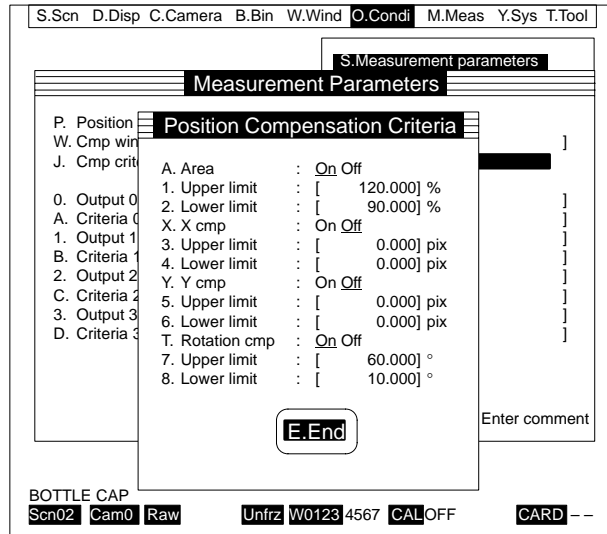

- Select "E. End." The contents of the settings will be displayed on the screen.

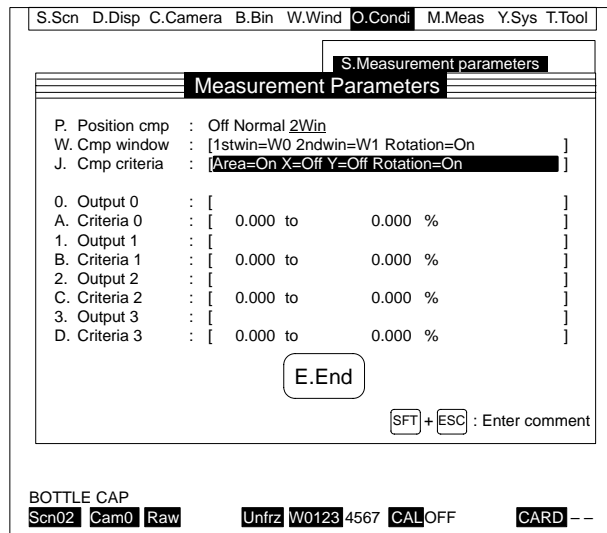

4-6-3 Setting the Output Expression

The items measured in each window are combined here, and the output expressions are set. The four mathematical operations can be carried out for the measurement object, reference value, and constant. Four output expressions can be set for each camera, and the measurement results can be output as the measured value. In addition, judgement results can be output for each output expression. For details, refer to 4-6-4 Setting Output Expression Criteria.

Measurable Items

With the F200, the area, center (coordinates), and axis angle in the window can be measured.

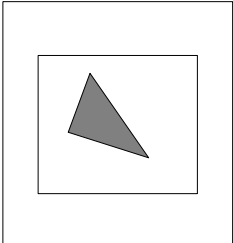
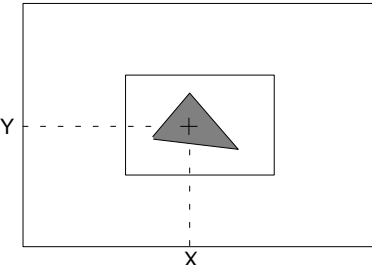
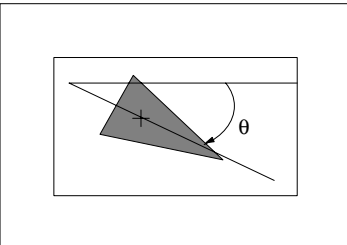
Item	Contents	
A. Area		Measures the area in a window.
X.X center Y.Y center		<p>X.X center Measures the center-of-gravity X coordinate in the window.</p> <p>Y.Y center Measures the center-of-gravity Y coordinate in the window.</p>
T. Axis angle		Measures the axis angle in the window. The range is indicated as 0 to 179.999°, with the X axis taken as 0° and the direction from the X axis to the Y axis taken as positive. The axis angle cannot be calculated for graphics such as squares or circles that have no directionality.

Setting the Expression

Aside from the area, center coordinates, and so on, other items such as the measurement results when saving the reference image, the constant, and so on can be set.

Examples:

- Outputting the area of Window 0
Expression: AR [W0]
- Outputting the amount of displacement from the reference value for the X coordinate of the center of gravity of Window 1.
Expression: XG [W1] – RXG [W1]

Expression Symbols for Measurement Items

Measurement item	Expression symbol	Contents
A. Area	AR	Area in window.
X. X center	XG	X coordinate of center of gravity in window.
Y. Y center	YG	Y coordinate of center of gravity in window.
T. Axis angle	TH	Axis angle in window.
1. Reference AR	RAR	Area in window when saving the reference image.
2. Reference XG	RXG	Center's X coordinate in window when saving the reference image.
3. Reference YG	RYG	Center's Y coordinate in window when saving the reference image.
4. Reference TH	RTH	Axis angle in window when saving the reference image.
C. Constant		0 ≤ numeral ≤ 2,147,483.647

Expression Symbols for Operators

Operator	Expression symbol	Contents
+ . +	+	Addition
- . -	-	Subtraction
* . *	*	Multiplication
/ . /	/	Division
L.((Left parenthesis
R.))	Right parenthesis

Note An error will result if any of the following situations occur when setting the expression.

- There is an overall difference between the number of left parentheses and the number of right parentheses in the expression.
- There is a measurement item to the right of a right parenthesis.
- There is a left parenthesis to the right of a right parenthesis.
- There is an operator to the right of an operator.
- There is no measurement item to the right of an operator.
- There is a measurement item to the right of a measurement item.
- There is a left parenthesis to the right of a measurement item.
- There is an operator to the right of a left parenthesis.
- There is no measurement item to the right of a left parenthesis.

When Two Cameras are Used

The output expressions can be set separately for each camera. Before setting the output expression, select the number of the camera for which the expression is to be set. For details, refer to 4-3-1 *Selecting Cameras*.

Note Measurement items for both camera 0 and camera 1 can be set for the output expressions. When executing operations between the cameras, select camera 1.

- 1, 2, 3... 1. Select the output number that is to be set. The screen for setting the output expression will be displayed.

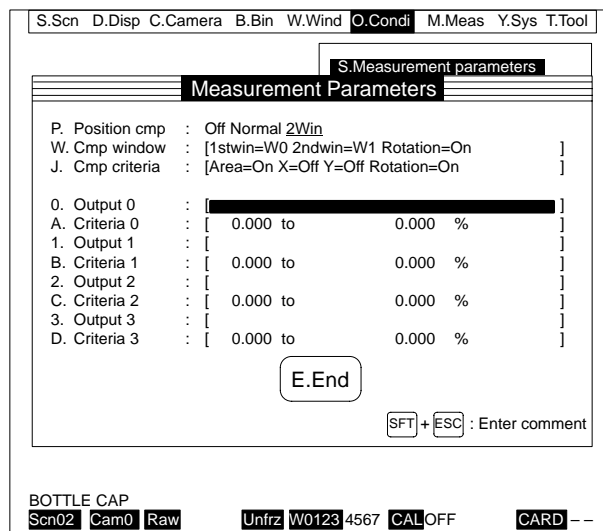

2. After making the selection, press the Enter Key. A screen will be displayed for selecting measurement items.

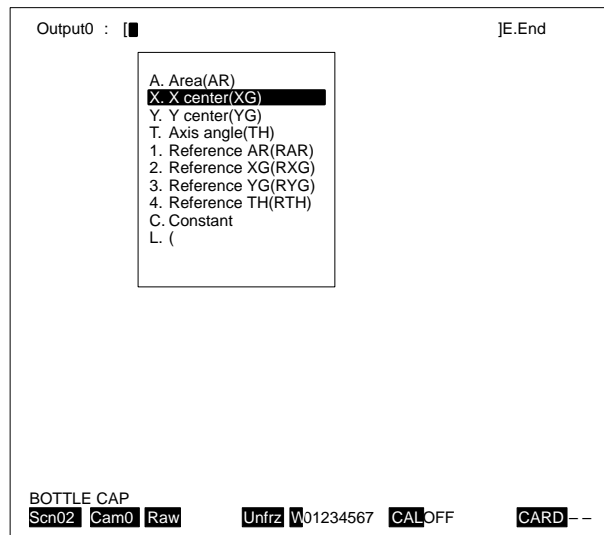

3. Select the measurement item. If it is necessary to select the window number, a screen for making the selection will be displayed. Select the window for which the measurement is to be executed. Windows for position displacement compensation cannot be used for measurement, however, so they are not displayed. When the measurement item is set, the cursor will move to the right.
4. Press the Enter Key. The screen for selecting the operator will be displayed.

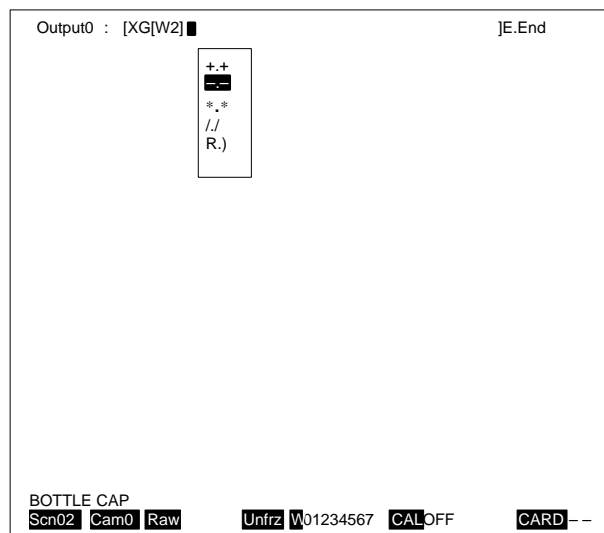

5. Select the operator. When the operator is set, the cursor will move to the right.
6. Press the Enter Key. The screen for selecting the measurement item will be displayed. Set the expression by repeating steps 3 through 5.

7. Select "E. End." The output expression will be set for that output number.

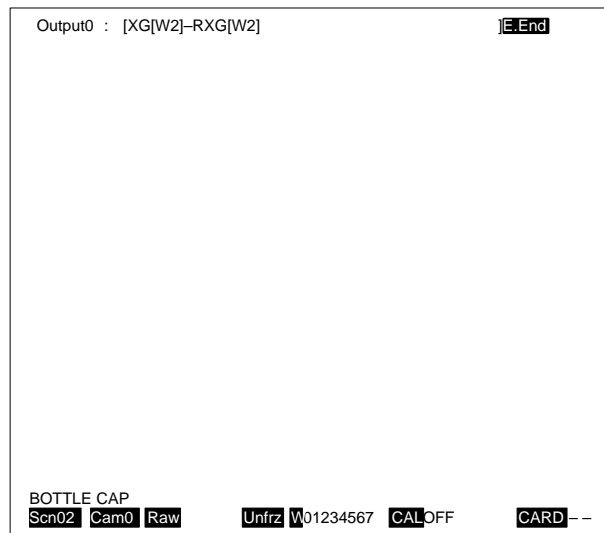

Changing the Expression

There are three methods for changing the output expression after it has already been set. These three methods, inserting, replacing, and deleting, are explained below.

1) Inserting

To change the output expression by means of "I. Insert," follow the procedure outlined below.

- 1, 2, 3... 1. Move the cursor to the position for making the insertion.
2. Press the Enter Key. The methods for changing the expression will be displayed.
3. Select "I. Insert." The measurement items or operators that can be inserted at the designated position will be displayed.

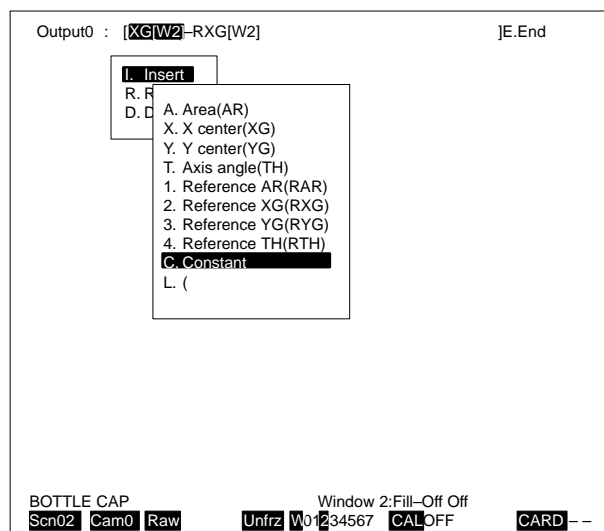

4. Select the item. It will be inserted in front of the cursor position.

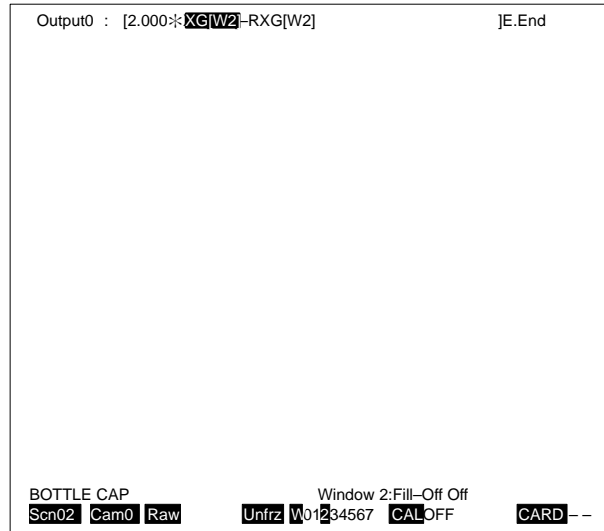

2) Replacing

To change the output expression by means of “R. Replace,” follow the procedure outlined below.

- 1, 2, 3...
1. Move the cursor to the item that is to be replaced.
 2. Press the Enter Key. The methods for changing the expression will be displayed.
 3. Select “R. Replace.”

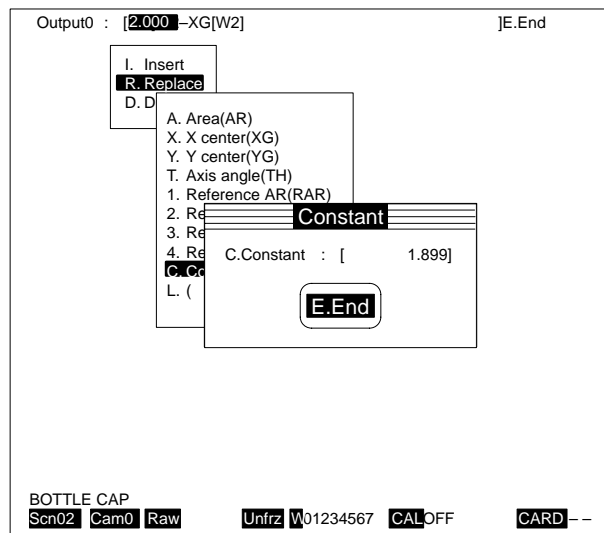

4. Select the item. The item at the cursor position will be replaced.

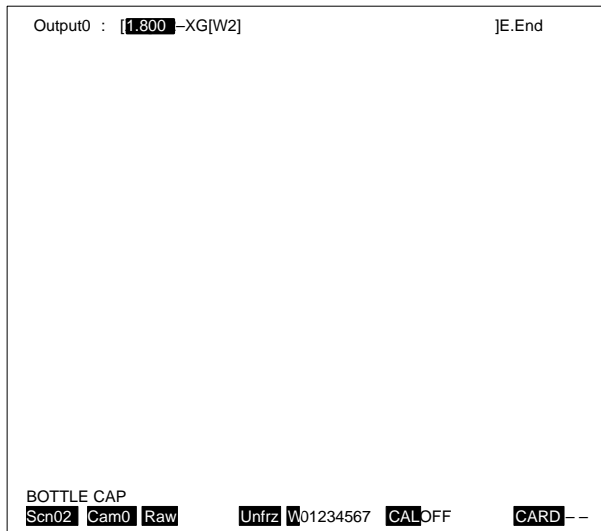

3) Deleting

To change the output expression by means of “D. Delete,” follow the procedure outlined below. (This procedure is for deleting items from the expression one by one. To delete the entire expression all at once, press the Shift and Enter Keys while setting the expression.)

- 1, 2, 3...**
1. Move the cursor to the item that is to be deleted.
 2. Press the Enter Key. The methods for changing the expression will be displayed.

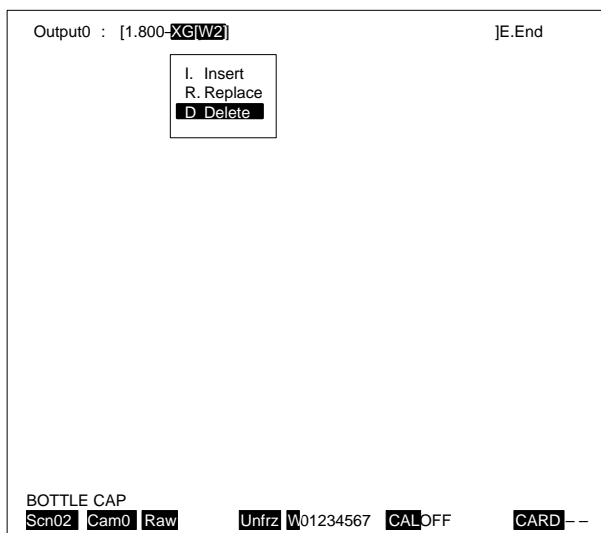

3. Select "D. Delete." The item at the cursor position will be deleted.

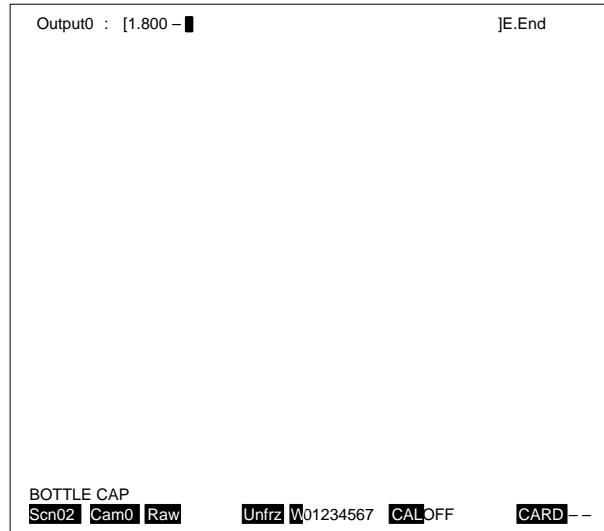

Adding Comments to Output Expressions

Comments can be added to output expressions and displayed at the video monitor as headings or titles for saving the reference images and measurement screens. It is convenient to input the contents of measurements in advance for checking screens during operations. A maximum of 16 normal-size alphanumeric characters can be entered for a comment.

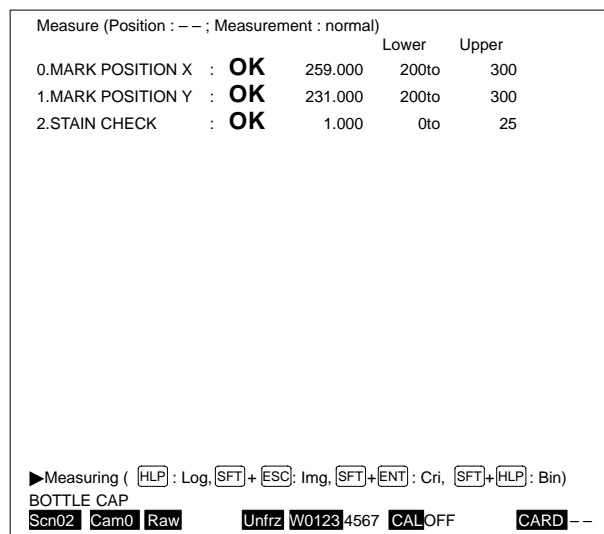

- 1, 2, 3... 1. Select "S. Measurement parameters."
2. Move the cursor to any place other than "E. End," and press the Shift and Escape Keys. The screen will be displayed for entering comments.

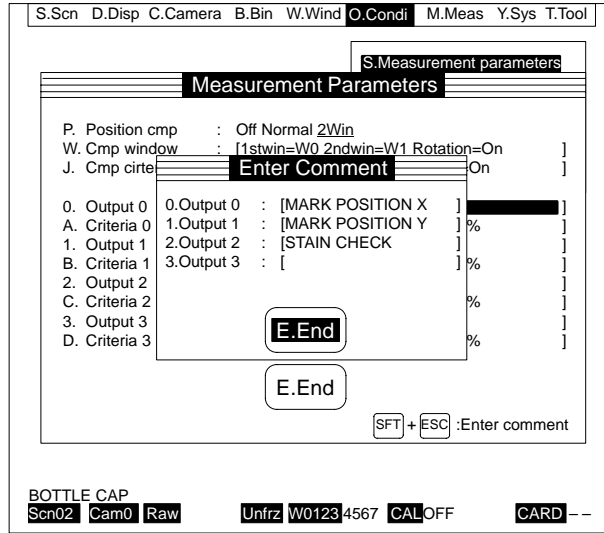

3. Enter comments for the output expressions. For instructions on inputting characters, refer to 1-4-5 *Inputting Characters*.
4. Select "E. End."

4-6-4 Setting Output Expression Criteria

The measurement results for an output expression can be judged as either OK or NG, and the results of that judgement can be output to every output device. For details, refer to 4-7-2 *Outputting Measurement Results*. The upper and lower limits can be set for the acceptable range (i.e., for a judgement of "OK"). There are three methods, explained below, for inputting the criteria.

If either "Percentage" or "Difference" is selected as the method, upper and lower limits must be input for measurement results with respect to a reference image (i.e., a standard that is set). Save the reference image before setting the criteria. For details, refer to 4-6-5 *Saving Reference Images*.

1) Percentage (%)

The first method is to take a reference value as 100% for reference, and then to input a percentage of that reference value. In the example shown below, the area of a circle is judged as to whether it meets the criteria. The criteria are 90% for the lower limit and 120% for the upper limit.

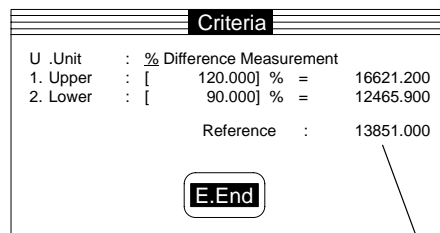
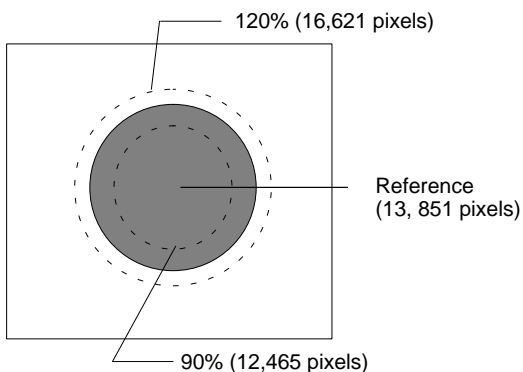

The reference value is displayed.

2) Difference

The second method is to take a reference value for reference as 0, and to input the discrepancy between the reference figure and either the number of pixels or an angle. If calibration is set to ON, the criteria is input in post-calibration units. In the example shown below, an angle is judged as to whether it meets the criteria. The criteria are -20° for the lower limit and $+20^\circ$ for the upper limit.

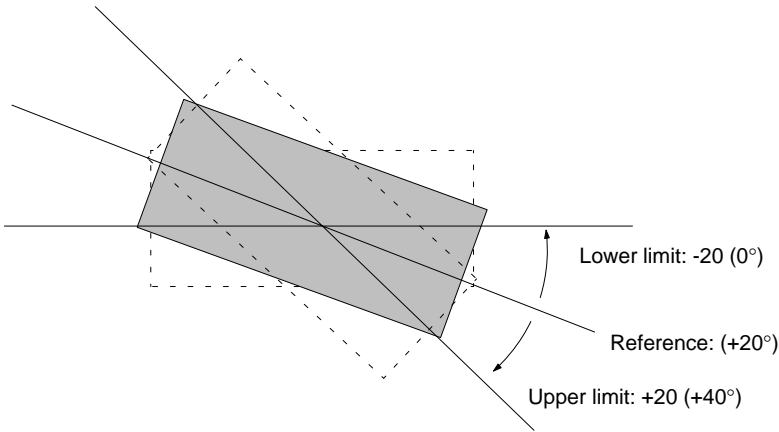

Criteria			
U. Unit	:	% Difference	Measurement
1. Upper	:	[20.000] pix =	40.000
2. Lower	:	[-20.000] pix =	0.000
	:	Reference	: 20.000
E.End			

The reference value is displayed.

3) Measurement

The third method is to input measured values. If calibration is set to ON, the criteria is input in post-calibration units. In the example shown below, a position is judged as to whether it meets the criteria. The criteria are 200 mm for the lower limit and 300 mm for the upper limit.

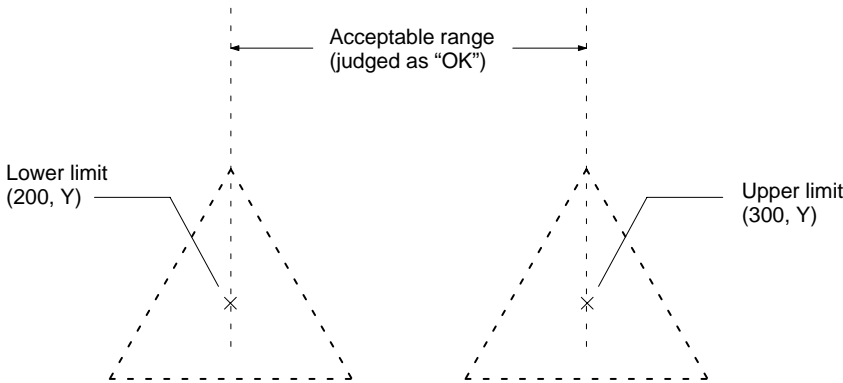

Criteria			
U. Unit	:	% Difference	Measurement
1. Upper	:	[300.000] mm =	300.000
2. Lower	:	[200.000] mm =	200.000
	:	Reference	: 255.000
E.End			

The reference value is displayed.

Procedure

Follow the procedure outlined below to select the method for setting the output expression criteria.

- 1, 2, 3...** 1. Select "S. Measurement parameters." The criteria numbers corresponding to the output expression numbers will be displayed.

2. Select the criteria number that is to be set.

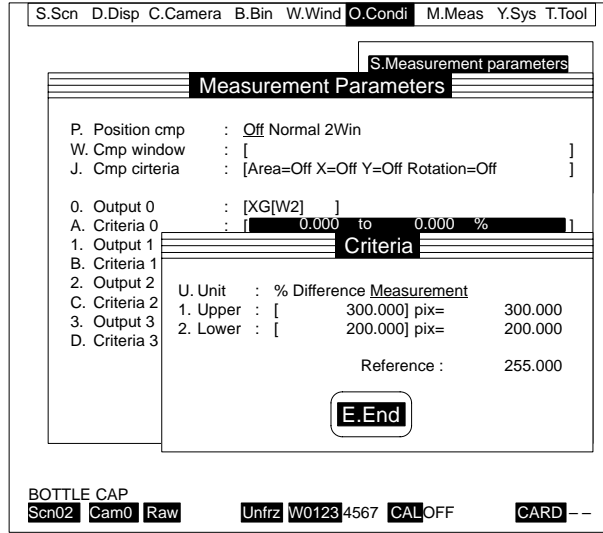

3. Select "U. Unit," and select the method for inputting the criteria.
4. Enter the upper and lower limits. The upper limit must be greater than or equal to the lower limit.
5. Select "E. End."

Note Do not change the unit after the upper and lower limits have been input. Doing so will cause the criteria to be changed.

4-6-5 Saving Reference Images

A reference image is a reference value which is saved for use as a reference in judging an output expression as "OK" or "NG," or in judging the amount of position displacement that must be compensated for. The reference position for position displacement compensation should be registered. There are three ways to save reference images. The first way is to save position and criteria together, the second is to save position separately, and the third is to save criteria separately. These items can be saved for each camera independently or for all the cameras together. These three methods are explained in the following table. Select the method first, before saving the reference images.

Position and criteria	The position standard and criteria standard are saved at the same time. If position displacement compensation is not being used, then only the criteria standard will be saved.
Position (See note.)	The standard object is measured, and its position is saved as the position standard to be used for position displacement compensation. When a judgement of position displacement is executed, the standard value for determining the amount of position displacement is saved at the same time.
Criteria	The standard object is measured, and that measured value is taken as the standard for judging the output expression. If position displacement compensation is being used, the criteria is saved after the compensation has been executed. Therefore, when using position displacement compensation, save the position standard in advance.

- 1, 2, 3...**
1. Select "R. Reference image." The methods for saving the reference images will be displayed. (They will not be displayed, however, for cameras that are not being used for measurement.)

2. Select the method for saving the reference images. The screen for saving them will be displayed.

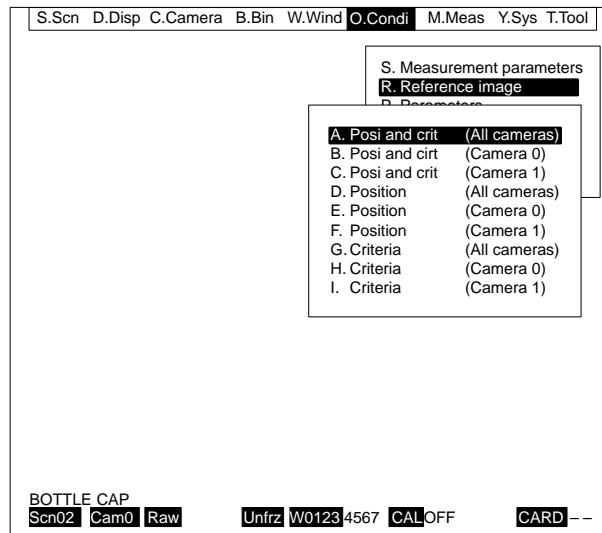

3. Set the position that is to be saved for the standard object.

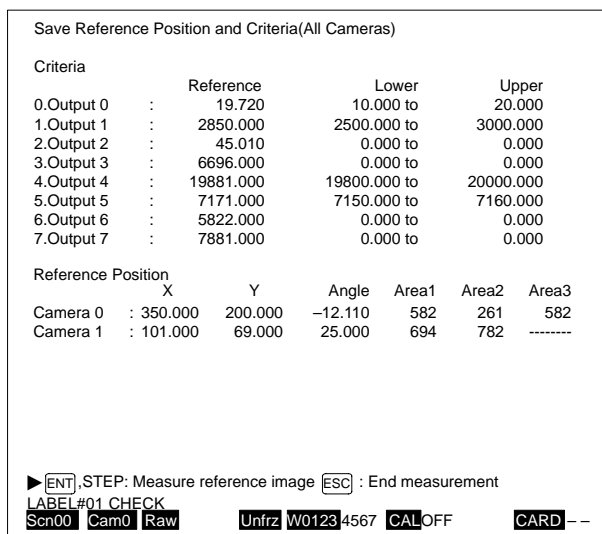

4. Press the Enter Key or input the STEP signal. The image will be measured and the results will be displayed. (The measurement can be carried out several times by means of the Enter Key or STEP signal. The measured value that is saved, however, will be the last one.)

5. Press the Escape Key. A message will be displayed asking for confirmation.

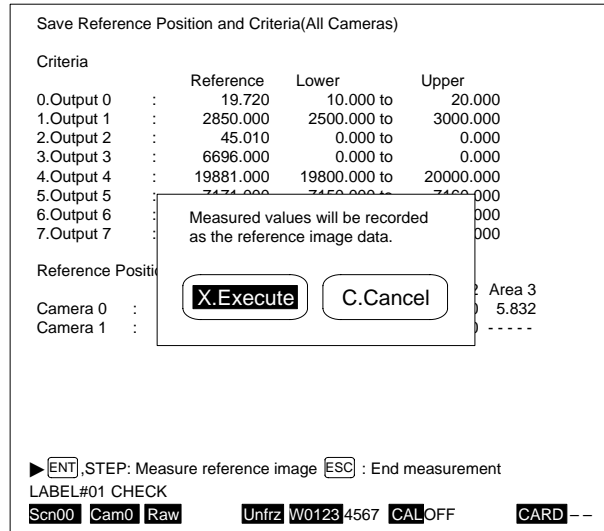

6. Select "X. Execute." The reference values displayed on the screen will be saved.

Note The items shown in the table below can be saved as standards by means of the "Position" method. Their contents vary depending on the mode ("Normal" or "Two windows") that is set.

Item	Normal	Two windows
X	X coordinate for center of gravity	X coordinate for mid-point
Y	Y coordinate for center of gravity	Y coordinate for mid-point
Angle	Main axis angle	Inclination between centers of gravity for Window 1 and Window 2
Area 1	Area of the window for measuring the amount of displacement in the X direction	Area of Window 1
Area 2	Area of the window for measuring the amount of displacement in the Y direction	Area of Window 2
Area 3	Area of the window for measuring the amount of displacement in the direction of rotation	---

4-6-6 Checking Data Set by O. Conditions

A list showing the data set for “O. Conditions” can be displayed for verification. The settings are listed individually for each camera.

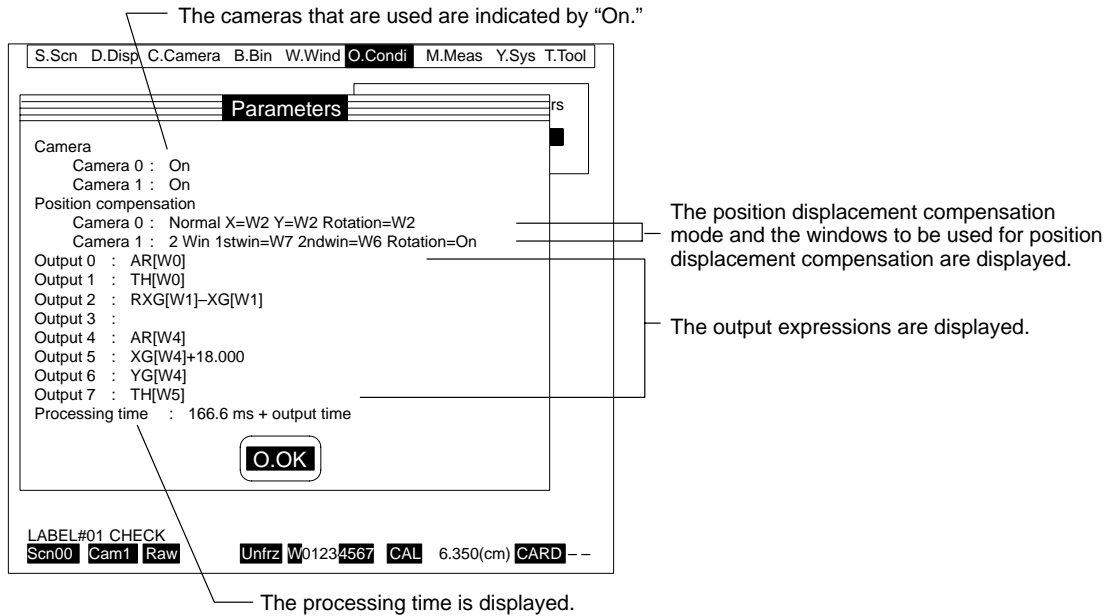

The processing time is the time from when a measurement command is input until the measurement processing has been completed. If the input device is set to “STEP signal,” then the next command cannot be input during that interval. Therefore the processing time must be taken into account when inputting commands. The processing time will vary depending on whether position displacement compensation is used, and on the measurement speed settings. For details, refer to *Appendix B Measurement Time Charts*.

The output time is the time it takes to output the measurement results to an output device. If the input device is set to “Console,” “I/O Unit,” or “RS-232C,” the next command cannot be input during the period of the processing time and output time combined. The output time will vary depending on the designated output device. For details, refer to *Appendix B Measurement Time Charts*.

- 1, 2, 3... 1. Select “P. Parameters.” The data list will be displayed.
2. Select “O. OK.”

4-7 Measurement

M. Measurement

Data for carrying out actual measurement processing is set under the “M. Measurement” menu. The input devices for measurement commands and output devices for outputting data are set for each scene, and measurements are executed based on scene data and system data. The operations accessed in the submenu shown below are explained on subsequent pages.

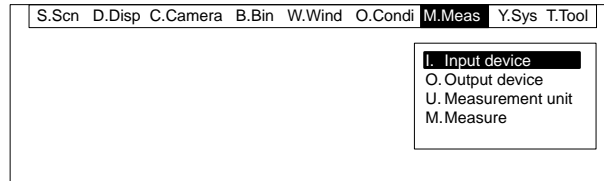

4-7-1 Inputting Commands at Measurement Screens

The device for inputting commands at measurement screens can be selected. There are five types of input device, and multiple devices can be selected. Make sure that the designated devices have been connected and wired in advance. For instructions on wiring the devices, refer to *2-5 Connecting Peripheral Devices*. The types of commands that can be input will vary depending on the input devices used.

Command Input Timing

Until the processing has been completed for a command, the next command that is input will be ignored. If a Terminal Block Unit or a Parallel I/O Unit is mounted, the BUSY signal will be ON during processing. Confirm that the BUSY signal has turned OFF before inputting the next command. (Refer to *Appendix B Measurement Timing Charts*.)

If commands are input from several input devices at the same time, the command from the device with the highest priority will be valid. The order of priority is as follows:

When “Continuous measurement” is OFF

STEP signal > Console > RS-232C > I/O Unit

When “Continuous measurement” is ON

Measurement commands that are input are ignored. The order of priority for other commands is as follows: Console > RS-232C > I/O Unit.

The commands shown below can always be input, regardless of which input devices are designated.

Console:	Quit measurement, Reset
RS-232C (Channel 0):	Quit measurement

Input Devices

There are five types of input device, as follows: Continuous measurement, Console, RS-232C, I/O Unit, and STEP signal. These input devices are described below.

1) Continuous

With continuous measurement, measurements are repeated automatically when there are inputs to the measurement screen.

2) Console

The commands shown in the following table can be input from the console.

Command	Key input	Function
Measure	Enter Key	Executed one measurement.
Switch camera	Right Key/Left Key	Switches image display camera numbers.
Switch scene	Shift Key + Up Key	Increments the scene number.
	Shift Key + Down Key	Decrements the scene number.
Quit measurement	Escape Key	Quits the measurement.
Reset	Shift Key + Help Key + Enter Key (Hold keys down for 1 second.)	Resets the F200 and restores the status at startup.
Measurement history*	Help Key	The results of the most recent measurements will be displayed, up to a maximum of 128 items.
Change displayed image*	Shift Key + Escape Key	Displays the screen for changing the displayed image.
Change criteria*	Shift Key + Enter Key	Displays the screen for changing the criteria for output expressions.
Change binary level*	Shift Key + Help Key	Displays the screen for changing the binary level.

Note For details, refer to *4-7-5 Changing Images and Criteria at Measurement Screens*.

3) RS-232C

The following commands can be input in ASCII code via RS-232C. Either channel 0 or channel 1 can be selected for inputting the commands. Set the communications specifications and the delimiters to match the external devices that are connected. For details, refer to *4-8-2 Setting RS-232C Communications Specifications*.

Measure

M(\$4D) m(\$6D)	Delimiter
--------------------	-----------

Executes one measurement.

Switch Camera

CTRL+S(\$13)	or	CTRL+D(\$04)
--------------	----	--------------

Switches cameras to display in a scene.

Switch Scene

CTRL+E(\$05)

Increments the scene number.

CTRL+X(\$18)

Decrements the scene number.

S(\$53) s(\$73)	Scene No. (0 to 15)	Delimiter
--------------------	------------------------	-----------

Switches to the designated scene number.

Save Reference Image

Position and Criteria

R(\$52) r(\$72)	Delimiter
--------------------	-----------

Saves reference position and criteria at the same time.

Position

R(\$52) r(\$72)	P(\$50) p(\$70)	Delimiter
--------------------	--------------------	-----------

Saves the reference position for measuring the amount of displacement when position displacement compensation is used.

Criteria

R(\$52) r(\$72)	J(\$4A) j(\$6A)	Delimiter
--------------------	--------------------	-----------

Saves the reference values for judging output expressions.

Change Binary Level

Upper Limit

U(\$55) u(\$75)	Window No. (0 to 7)	,\$(2C)	Upper limit (0 to 255)	Delimiter
--------------------	------------------------	---------	---------------------------	-----------

Changes the binary level upper limit for the designated window number. The upper limit must be greater than or equal to the lower limit.

Lower Limit

L(\$4C) l(\$6C)	Window No. (0 to 7)	,\$(2C)	Lower limit (0 to 255)	Delimiter
--------------------	------------------------	---------	---------------------------	-----------

Changes the binary level lower limit for the designated window number. The lower limit must be less than or equal to the upper limit.

Quit Measurement

Q(\$51) q(\$71)	Delimiter
--------------------	-----------

Quits the measurement.

Reset

I(\$49) i(\$69)	Delimiter
--------------------	-----------

Resets the F200 and restores the status at startup.

Save Scene Data

RS-232C

V(\$56) v(\$76)	R(\$52) r(\$72)	Beginning Scene No. (0 to 15)	,\$(2C)	Ending Scene No. (0 to 15)	Delimiter
--------------------	--------------------	----------------------------------	---------	-------------------------------	-----------

Saves scene data within a designated range via RS-232C channel 0.

Memory Card

V(\$56) v(\$76)	F(\$46) f(\$66)	Filename	,\$(2C)	Scene No. (0 to 15)	Delimiter
--------------------	--------------------	----------	---------	------------------------	-----------

Saves designated scene data with a designated filename to a memory card.

Enter a filename of eight characters or less. An extension (.SCN) must be added after the filename. (Example: SCENE01.SCN)

Load Scene Data

RS-232C

O(\$4F) o(\$6F)	R(\$52) r(\$72)	Delimiter
--------------------	--------------------	-----------

Loads scene data via RS-232C channel 0. When a command is input, the F200 goes into reception mode. Transmit the scene data from a device connected to channel 0. The data will be loaded to a scene that has been saved.

Memory Card

O(\$4F) o(\$6F)	F(\$46) f(\$66)	Filename	,\$(2C)	Scene No. (0 to 15)	Delimiter
--------------------	--------------------	----------	---------	------------------------	-----------

Loads scene data from a designated file on the memory card to a designated scene.

Enter a filename of eight characters or less. An extension (.SCN) must be added after the filename. (Example: SCENE01.SCN)

Save System Data

RS-232C

Y(\$59) y(\$79)	R(\$52) r(\$72)	Delimiter
--------------------	--------------------	-----------

Saves system data via RS-232C channel 0.

Memory Card

Y(\$59) y(\$79)	F(\$46) f(\$66)	Filename	Delimiter
--------------------	--------------------	----------	-----------

Saves system data with a designated filename to a memory card.

Enter a filename of eight characters or less. An extension (.ENV) must be added after the filename. (Example: SYSTEM01.ENV)

Load System Data

RS-232C

T(\$54) t(\$74)	R(\$52) r(\$72)	Delimiter
--------------------	--------------------	-----------

Loads system data via RS-232C channel 0. When a command is input, the F200 goes into reception mode. Transmit the system data from a device connected to channel 0.

Memory Card

T(\$54) t(\$74)	F(\$46) f(\$66)	Filename	Delimiter
--------------------	--------------------	----------	-----------

Loads system data from a designated file on the memory card to a designated scene.

Enter a filename of eight characters or less. An extension (.ENV) must be added after the filename. (Example: SYSTEM01.ENV)

Change Criteria

Upper Limit

J(\$4A) j(\$6A)	Output No. (0 to 7)	,\$(2C)	Upper limit	Delimiter
--------------------	------------------------	---------	-------------	-----------

Changes the upper limit for the criteria for the designated output number. The unit is fixed as "Measurement."

Lower Limit

K(\$4B) k(\$6B)	Output No.	,\$(2C)	Lower limit	Delimiter
--------------------	------------	---------	-------------	-----------

Changes the lower limit for the criteria for the designated output number. The unit is fixed as "Measurement."

The range for the upper and lower limits is -2,147,483.648 to 2,147,483.647. The upper limit must be greater than or equal to the lower limit.

Obtain Measured Value

Input Format

D(\$44) d(\$64)	Data 1	,(\$2C)	Data 2	Delimiter
--------------------	--------	---------	--------	-----------

The contents that are input to Data 1 and Data 2 will vary depending on the measured values that are obtained.

Regardless of the output expression, this command obtains the measured value for any measurement item and outputs it to channel 0. This command does not actually carry out a measurement itself, but simply obtains the results of immediately preceding measurements. In addition, it is only possible to obtain measured values for the window for which the output expression is set.

Measured value to be obtained		Data 1	Data 2
Area		0	Window number (0 to 7)
X center of gravity		1	
Y center of gravity		2	
Axis angle		3	
Output expression		4	Output number (0 to 7)
Output expression reference (reference value)		5	
Position displacement compensation	Amount of X displacement	6	Camera number (0, 1)
	Amount of Y displacement	7	
	Amount of angle displacement	8	
	X reference position	9	
	Y reference position	10	
	Angle reference position	11	

Output Format

D(\$44)	Data 1	,(\$2C)	Data 2	,(\$2C)	Meas. val. (8 integer digits)	,(\$2E)	Meas. val. (3 decimal digits)	Delimiter
---------	--------	---------	--------	---------	----------------------------------	---------	----------------------------------	-----------

At Data 1 and Data 2, the data that was input with the input format will be output. The measured value will be output with eight integer digits and three decimal digits. Blank spaces in the measured value will be output as spaces (\$20).

The range that can be output is as follows:

- When calibration is set to OFF, the range is $-2,147,483.648 \leq \text{Measured value} \leq 2,147,483.647$. If that range is exceeded, the values that are output will be unreliable.
- When calibration is set to ON, the range is $-9,999,999.999 \leq \text{Measured value} \leq 9,999,999.999$. If the measured value is less than $-9,999,999.999$, then $-9,999,999.999$ will be output. If the measured value is greater than $9,999,999.999$, then $9,999,999.999$ will be output.

4) I/O Unit

The commands shown in the following table can be input from a Parallel I/O Unit or a Terminal Block Unit. "ON" status for each bit is indicated by "1," and "OFF" status is indicated by "0."

Command	Input data (DI: 7 6 5 4 3 2 1 0)	Function
Measure	* * * 1 * * * *	Measures continuously while commands are being input.
Switch scenes	* * 1 0 (Scene No.) Example: 0 0 1 0 0 0 1 0 ·····	Switches the scene to be measured. Determine DI0 through DI3, and turn ON DI5 after 1 ms.
Save reference image	* 1 0 0 1 0 1 0	Repeatedly saves the criteria standard while DI6 is ON. Determine DI0 through DI3, and turn ON DI6 after 1 ms.
	* 1 0 0 1 0 0 1	Repeatedly saves the position standard while DI6 is ON. Determine DI0 to DI3, and turn ON DI6 after 1 ms.
	* 1 0 0 1 0 0 0	Repeatedly saves the criteria and position standards together while DI6 is ON. Determine DI0 through DI3, and turn ON DI6 after 1 ms.
	* 1 0 0 0 0 1 0	While DI0 through DI7 are set as shown on the left, the criteria standard will be saved with the input of a STEP signal. Determine DI0 through DI3, and turn ON DI6 after 1 ms. Execution will be synchronous with the leading edge (OFF→ON) of the STEP signal.
	* 1 0 0 0 0 0 1	While DI0 through DI7 are set as shown on the left, the position standard will be saved with the input of a STEP signal. Determine DI0 through DI3, and turn ON DI6 after 1 ms. Execution will be synchronous with the leading edge (OFF→ON) of the STEP signal.
	* 1 0 0 0 0 0 0	While DI0 through DI7 are set as shown on the left, the criteria and position standards will be saved with the input of a STEP signal. Determine DI0 through DI3, and turn ON DI6 after 1 ms. Execution will be synchronous with the leading edge (OFF→ON) of the STEP signal.

Note When commands are input simultaneously, the order of priority is as follows:
Measure > Switch scenes > Save reference image
For example, if 01011001 is input, the measurement will be executed.

5) STEP Signal

With this method, one measurement will be executed in synchronicity with the leading edge (OFF→ON) of the STEP signal.

Note Several Terminal Block Units can be mounted in an F200 System. Even though it is possible for STEP signals to be input from any of those Units, set up the system so that the STEP signals are input from the Terminal Block Unit closest to the Power Supply Unit.

Procedure

To select the device for inputting commands, follow the procedure outlined below.

- 1, 2, 3...**
1. Select "I. Input device."
 2. Set the desired input devices to ON. (More than one device can be set to ON.)

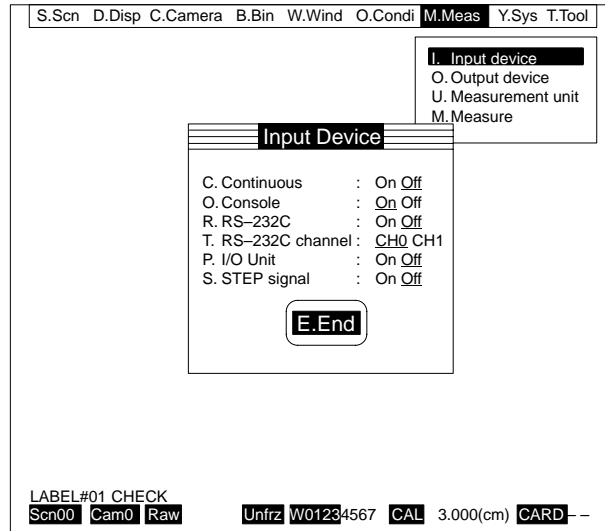

3. Select "E. End."

4-7-2 Outputting Measurement Results

The devices for outputting measurement results can also be selected. There are four choices (video monitor, RS-232C, I/O Unit, and memory card), and more than one of them can be selected. In addition, the data that is to be output (either judgement results or measured values, or both) can be selected individually for each output device.

Make sure that the designated devices have been connected and wired in advance. For instructions on wiring the devices, refer to *2-5 Connecting Peripheral Devices*. In addition, when RS-232C, Terminal Block Units, or Parallel I/O Units are used, the communications and output specifications must be set. For details, refer to *4-8-2 Setting RS-232C Communications Specifications* and *4-8-3 Setting Parallel Data Output Specifications*.

1) Video Monitor

Output data is displayed on the video monitor as shown below.

Output numbers for which output expressions are set are displayed here. If comments have been entered, the comments will be displayed.

The currently set measurement speed is displayed here.

When judgement results are output with respect to output expressions, the results are displayed here (as either OK or NG).

When judgement results are output, criteria are displayed here. If calibration is set to ON, the values after calibration are displayed.

When measured values for output expressions are output, they are displayed here.

Measure (Position : fast ; Measurement : fast)	Lower	Upper
0.LABEL POSITION X : NG	984.000	1to 2
1.LABEL POSITION Y : NG	435.000	-150to 200
2.STAIN CHECK : NG	0.000	1to 1
4.Output 4 : NG	0.000	5239to 6986
5.Output 5 : NG	435.000	180to 220
6.Output 6 : NG	13.500	200to 300
7.Output 7 : NG	0.000	-5to 5

►Measuring ([HLP]: Log, [SFT]+[ESC]: Img, [SFT]+[ENT]: Cri, [SFT]+[HLP]: Bin)
 LABEL#01 CHECK
 Scn00 Cam0 Raw Unfrz W01234567 CAL 3.000(cm) CARD--

If position displacement compensation is being used, the window for position displacement compensation will be displayed. In addition, a cross cursor will be displayed at the center-of-gravity position of the measurement window. The inclination of the long line of the cross cursor will indicate the axis angle.

Note The range that can be output is as follows:

When calibration is set to OFF, the range is $-2,147,483.648 \leq \text{Measured value} \leq 2,147,483.647$. If that range is exceeded, the values that are output will be unreliable.

When calibration is set to ON, the range is $-9,999,999.999 \leq \text{Measured value} \leq 9,999,999.999$. If the measured value is less than $-9,999,999.999$, then $-9,999,999.999$ will be output. If the measured value is greater than $9,999,999.999$, then $9,999,999.999$ will be output.

2) RS-232C

The following formats can be output at either channel 0 or channel 1, whichever is designated. The data will be in ASCII code, and the output numbers will be output in order from smallest to largest.

Set the communications specifications and delimiters to match the output devices that are connected. For details, refer to 4-8-2 *Setting RS-232C Communications Specifications*.

Outputting Judgement Results Only

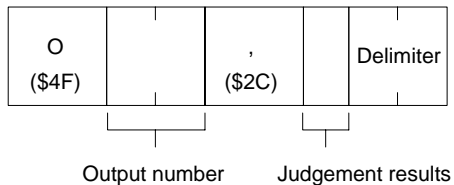

Outputting Measured Values Only

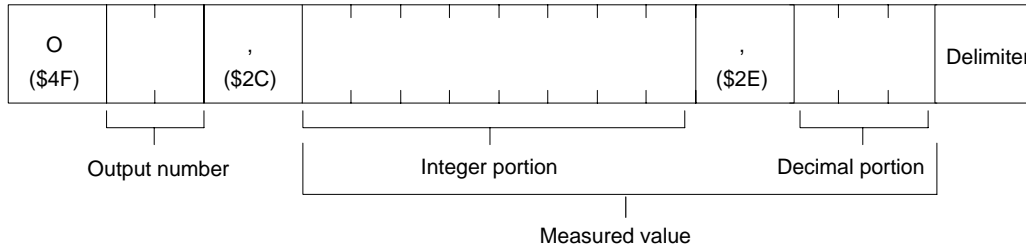

Outputting Judgement Results and Measured Values

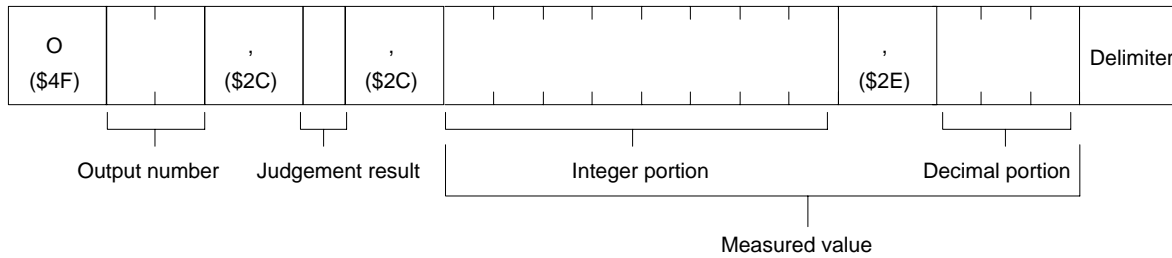

Output item	Contents
Output number	The output number is output (00 to 07).
Judgement results	The judgement results with respect to the output number are output (0: OK; 1: NG).
Measured values	<p>The measured value for the output number is output with eight integer digits and three decimal digits. Blank spaces in the measured value are output as spaces (\$20).</p> <p>The range that can be output is as follows:</p> <ul style="list-style-type: none"> When calibration is set to OFF, the range is $-2,147,483.648 \leq \text{Measured value} \leq 2,147,483.647$. If that range is exceeded, the values that are output will be unreliable. When calibration is set to ON, the range is $-9,999,999.999 \leq \text{Measured value} \leq 9,999,999.999$. If the measured value is less than $-9,999,999.999$, then $-9,999,999.999$ will be output. If the measured value is greater than $9,999,999.999$, then $9,999,999.999$ will be output.

Example:

In this example, the output number is “1” and the judgement is “NG,” the measured value is “-42,315.400”, and the delimiter is “LF.”

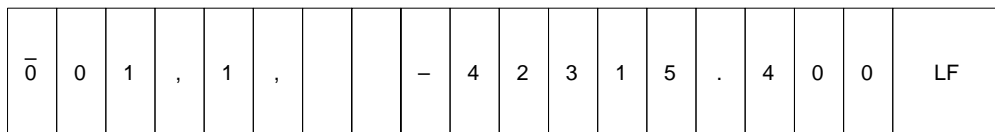

3) I/O Unit

Outputs can be made, in the formats shown below, to DO0 through DO31 of a Parallel I/O Unit, or DO0 through DO7 of a Terminal Block Unit. Measured values, however, cannot be output to Terminal Block Units. Measured values are output in order, from the smallest output number to the largest. In addition, if judgement results and measured values are both output, the judgement results will be output first, followed by the measured values.

Set the output specifications. For details, refer to *4-8-3 Setting Parallel Data Output Specifications*.

When Judgement Results are Output

The judgement results are output for each output expression individually.

DO	Output contents
0	Judgement result for output 0 (OFF: OK, ON: NG)
1	Judgement result for output 1 (OFF: OK, ON: NG)
2	Judgement result for output 2 (OFF: OK, ON: NG)
3	Judgement result for output 3 (OFF: OK, ON: NG)
4	Judgement result for output 4 (OFF: OK, ON: NG)
5	Judgement result for output 5 (OFF: OK, ON: NG)
6	Judgement result for output 6 (OFF: OK, ON: NG)
7	Judgement result for output 7 (OFF: OK, ON: NG)

Note When judgement results are output to a Terminal Block Unit, logic operations are executed for the judgement results of all output expressions for output to the AND and OR terminals. When all of the judgement results are NG, the AND terminal will turn ON. If even one of the judgement results is NG, the OR terminal will turn ON.

When Measured Values are Output

The ON status of bits is indicated by “1.” OFF is indicated by “0.”

BCD

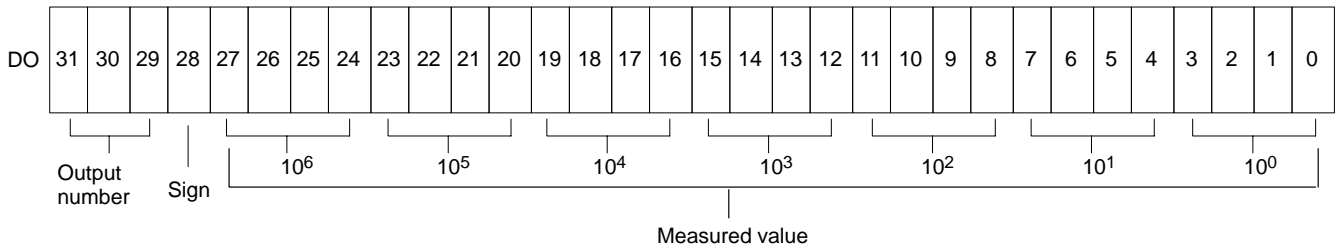

Output item	No. of bits	Contents
Output number	3	Outputs the output number (0 to 7) for the output data in binary.
Sign	1	Outputs the sign for the measured value. (0: positive; 1: negative)
Measured value	28	The absolute value of the measured value is output in 7 digits BCD. The decimal portion is eliminated. The range that can be output is as follows: <ul style="list-style-type: none"> • When calibration is set to OFF, the range is $-2,147,483 \leq \text{Measured value} \leq 2,147,483$. If that range is exceeded, the values that are output will be unreliable. • When calibration is set to ON, the range is $-9,999,999 \leq \text{Measured value} \leq 9,999,999$. If the measured value is less than -9,999,999, then -9,999,999 will be output. If the measured value is greater than 9,999,999, then 9,999,999 will be output.

Example:

In this example, the output number is “1” and the measured value is “-42,315”.

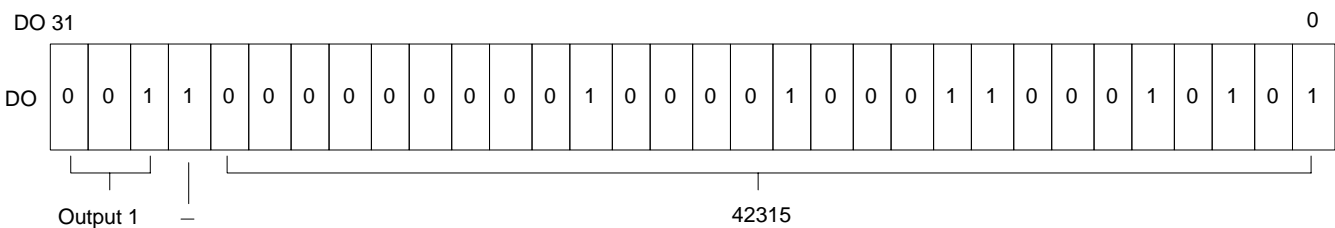

BIN

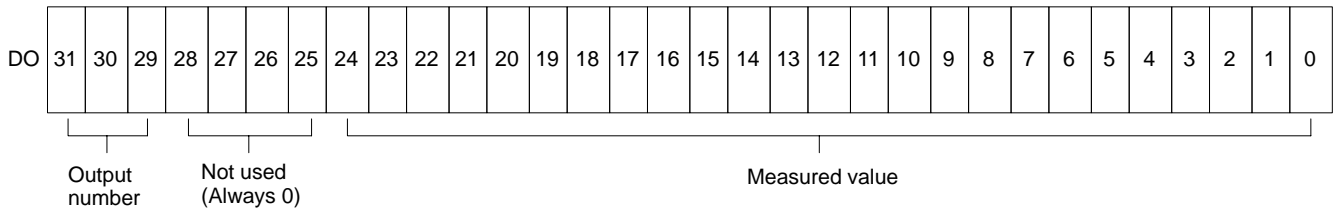

Output item	No. of bits	Contents
Output number	3	Outputs the output number (0 to 7) for the output data in binary.
Measured value	25	The integer portion of the measured value is output as a two's complement expression. The decimal portion is eliminated. The range that can be output is as follows: <ul style="list-style-type: none"> • When calibration is set to OFF, the range is $-2,147,483 \leq \text{Measured value} \leq 2,147,483$. If that range is exceeded, the values that are output will be unreliable. • When calibration is set to ON, the range is $-9,999,999 \leq \text{Measured value} \leq 9,999,999$. If the measured value is less than -9,999,999, then -9,999,999 will be output. If the measured value is greater than 9,999,999, then 9,999,999 will be output.

Example:

In this example, the output number is 1 and the measured value is “-42,315”.

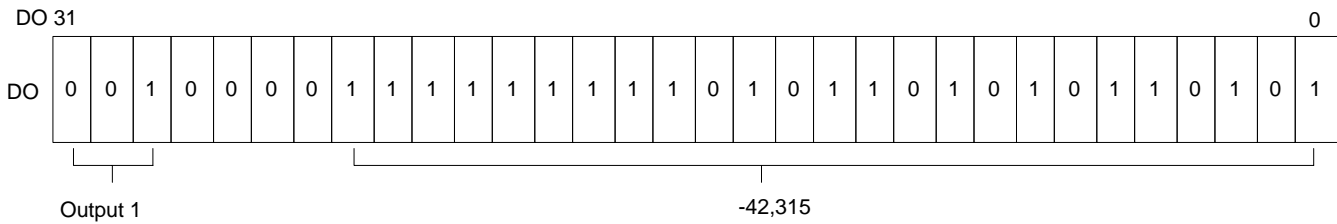

4) Memory Card

Outputs can be made to a designated file on a memory card. If an already existing file is designated, the output data will be added to the existing data in the designated file. If no files already exist with the designated filename, then a new file will be created under that filename and the data will be stored in that file. (The extension “.DAT” will be added automatically to the filename.) The data will be output in order, beginning with the lowest output number.

Outputting Judgement Results Only

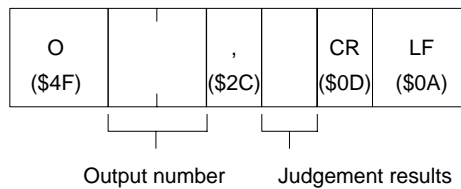

Outputting Measured Values Only

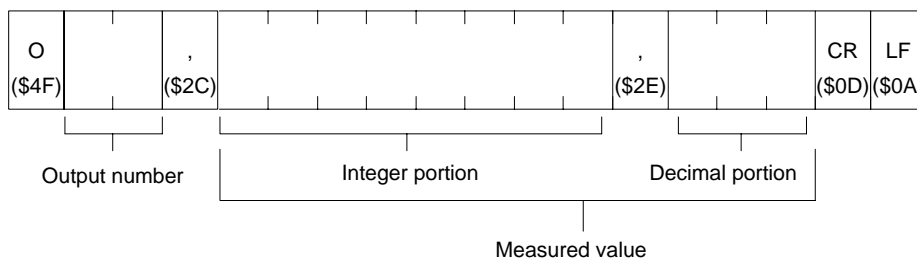

Outputting Judgement Results and Measured Values

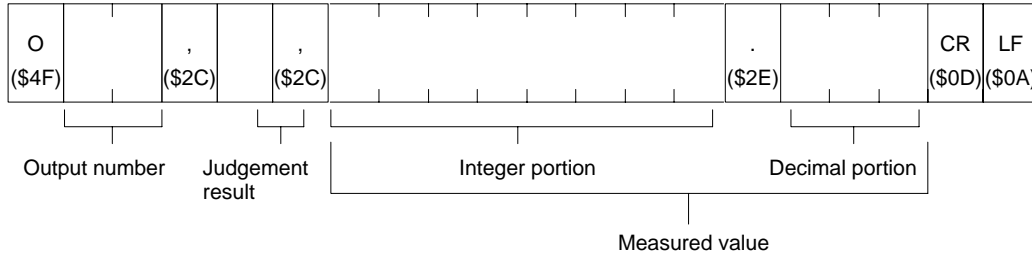

Note The delimiter for the data output to the memory card is fixed as CR and LF.

Output item	Contents
Output number	The output number is output (00 to 07).
Judgement results	The judgement results with respect to the output number are output (0: OK; 1: NG).
Measured values	<p>The measured value for the output number is output with eight integer digits and three decimal digits. Blank spaces in the measured value are output as spaces (\$20).</p> <p>The range that can be output is as follows:</p> <ul style="list-style-type: none"> • When calibration is set to OFF, the range is $-2,147,483.648 \leq \text{Measured value} \leq 2,147,483.647$. If that range is exceeded, the values that are output will be unreliable. • When calibration is set to ON, the range is $-9,999,999.999 \leq \text{Measured value} \leq 9,999,999.999$. If the measured value is less than $-9,999,999.999$, then $-9,999,999.999$ will be output. If the measured value is greater than $9,999,999.999$, then $9,999,999.999$ will be output.

Example:

In this example, the output number is “1,” the judgement is “NG,” the measured value is “-42,315.400”.

0	0	1	,	1	,				-	4	2	3	1	5	.	4	0	0	CR	LF
---	---	---	---	---	---	--	--	--	---	---	---	---	---	---	---	---	---	---	----	----

Procedure

To select the devices for outputting data, follow the procedure outlined below.

- 1, 2, 3... 1. Select "O. Output device."
2. Set the output device and the output data. Select the data type individually for each output device. If a memory card is selected as an output device, then enter the name of the file in which the data is to be saved. If RS-232C is selected, then select the channel for outputting the data.

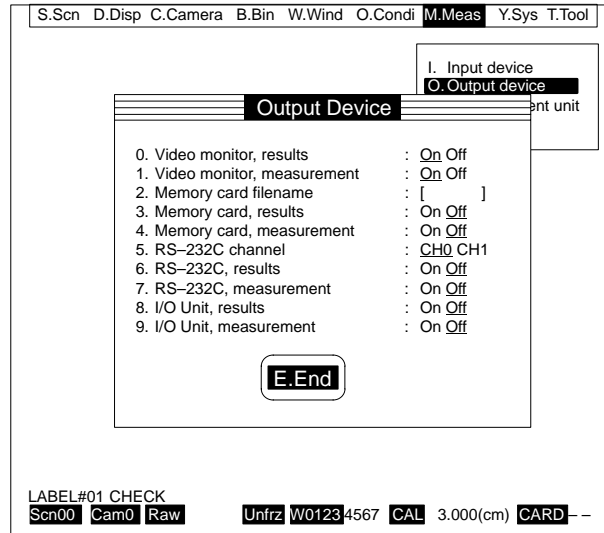

3. Select "E. End."

4-7-3 Outputting Measured Values in Actual Dimensions

Ordinarily measured values are output as the number of pixels, but the values can be converted to actual dimensions for output. If "C.calibration" is set to On, then the actual dimensions will be output based on converting the data that was previously created. For details, refer to 4-3-5 *Creating Data for Converting to Actual Dimensions*. If "C.calibration" is set to On, measured values are displayed in actual dimensions on the reference image saving screen and judgement condition setting screen. For details, refer to 4-6-5 *Saving Reference Images* and 4-6-4 *Setting Output Expression Criteria*.

- 1, 2, 3... 1. Select "U. Measurement unit."

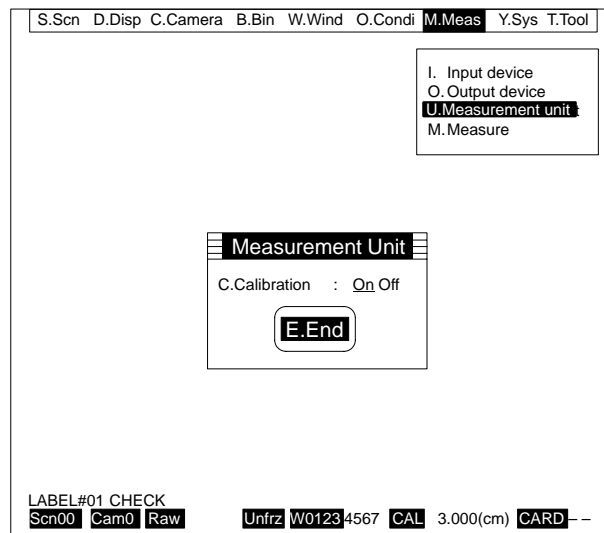

2. Set "Calibration" to "On."
3. Select "E. End."

4-7-4 Measuring

The screen shown below is called a Measurement Screen, and it is the screen on which measurements are actually executed. In an F200 System, measurements are carried out according to commands from input devices.

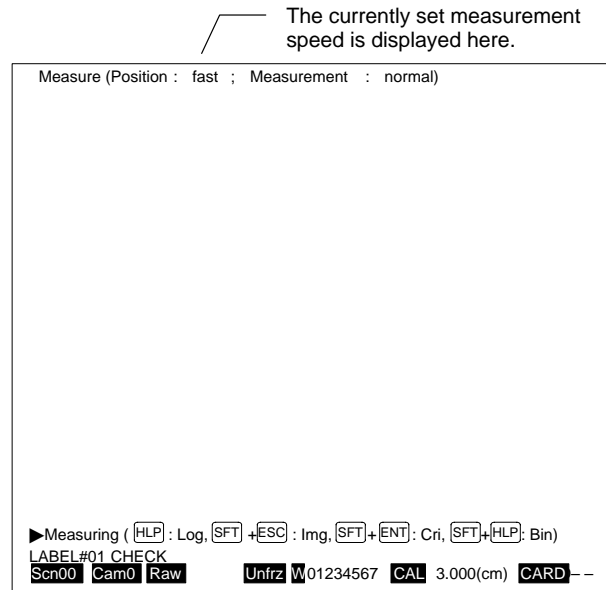

If position displacement compensation is being used, the window for position displacement compensation will be displayed. In addition, a cross cursor will be displayed at the center-of-gravity position of the measurement window. The inclination of the long line of the cross cursor will indicate the axis angle.

Procedure

To execute the measurement, select “M. Measure.” The measurement screen for the currently displayed scene will appear, and the measurement will be carried out according to commands from input devices. For details, refer to *4-7-1 Inputting Commands at Measurement Screens*. Measurement results will be output to the designated output devices. For details, refer to *4-7-2 Outputting Measurement Results*.

4-7-5 Changing Images and Criteria at Measurement Screens

The binary image can change as a result of environmental changes such as lighting fluctuations, and this can have an effect on the measurement results. In such cases, it may be necessary to change scene data such as the binary level and the criteria for the output expressions. At the measurement screen, those changes can be easily made from the console. In addition, changes to images and a log of measurement results can be displayed.

Note Inputs from the console must be set to ON. For details, refer to *4-7-1 Inputting Commands at Measurement Screens*. While the changes are being executed, no commands can be input. If a Terminal Block Unit or Parallel I/O Unit is mounted, the BUSY signal will be ON while the changes are being executed. All changes will be reflected in scene data.

Changing the Binary Level The binary level can be changed. For details, refer to 4-4-1 *Selecting the Binary Level Setting Method* and 4-4-2 *Setting the Binary Level*.

- 1, 2, 3...**
1. Press the Shift and Help Keys. The methods for setting the binary level will be displayed. Only the methods related to cameras and windows actually being used for measurement will be displayed.

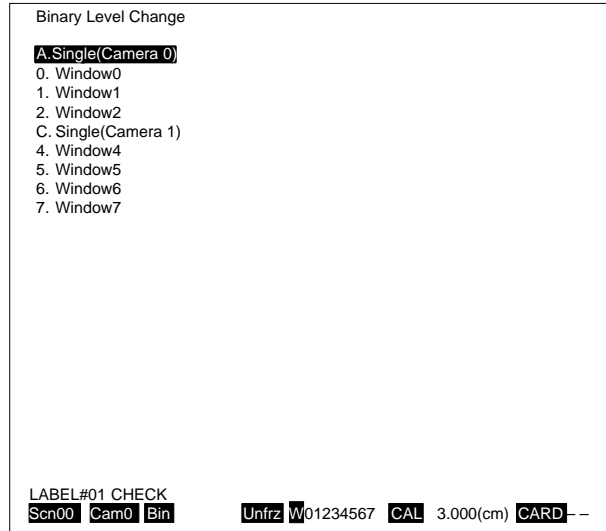

2. Select the method for setting the binary level. The binary level setting screen will be displayed.

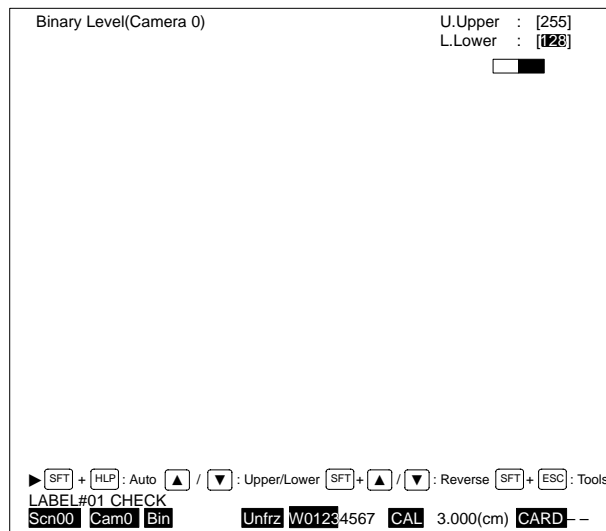

3. Set the binary level. To continue changing the binary level, repeat steps 2 and 3.
4. Press the Escape Key to return to the measurement screen.

Changing Criteria

For each output expression, the upper and lower limits of the acceptable range (i.e., the range within which a judgement of "OK" will be received) can be changed. For further details, refer to 4-6-4 Setting Output Expression Criteria.

- 1, 2, 3... 1. Press the Shift and Enter Keys. A cursor will be displayed for selecting the criteria.

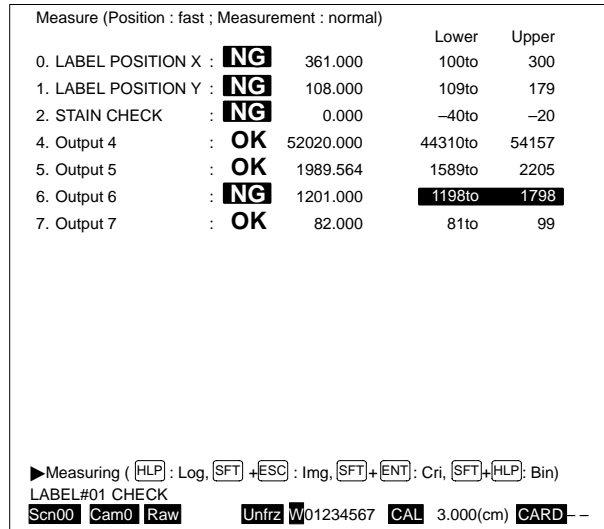

2. Select the criteria that is to be changed. First move the cursor to the position of the criteria, and then press the Enter Key.

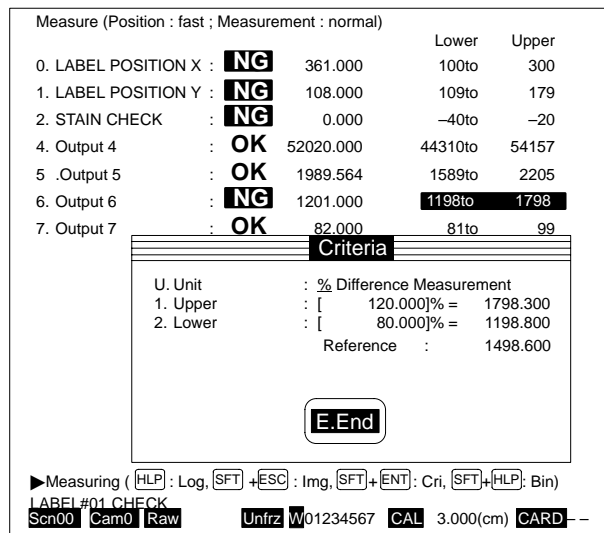

3. Select "U. Unit." The unit that is currently set will be underlined.
4. Enter the upper and lower limits. The upper limit must be greater than or equal to the lower limit.
5. Select "E. End." The criteria will be set. To continue making changes to the criteria, repeat steps 2 through 5.
6. Press the Escape Key to return to the measurement menu.

Changing Display Images A display image can be changed to raw, filtered, or binary. For details, refer to 4-2-1 *Selecting the Display Image Type*.

- 1, 2, 3... 1. Press the Shift and Escape Keys.
2. Select the display image type. The selected image will be displayed, and the measurement screen will return.

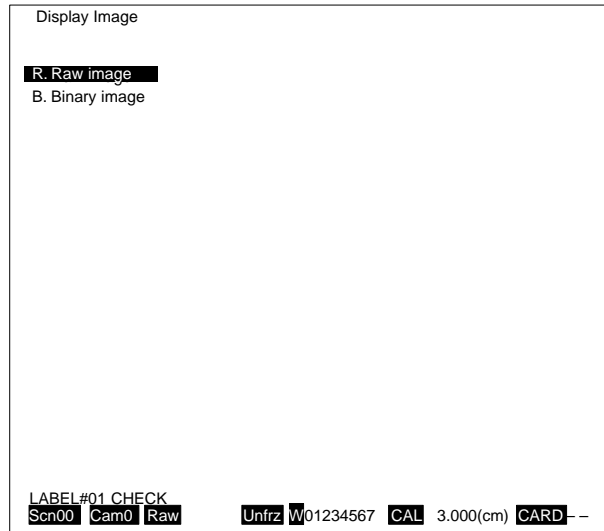

Displaying a Log of Measurement Results

A log of measured values and judgement results can be displayed for each output expression. The most recent items will be displayed, up to a maximum of 128. The log will be cleared when the scene displayed at the measurement screen is switched or when the user returns to the menus from the measurement screen.

Measurement Log Display(3/5)							
Out 0	Out 1	Out 2	Out 3	Out 4	Out 5	Out 6	Out 7
29180	254	161		10385	6126	266	260
29182	255	161		10385	6126	266	260
28601	254	161		10385	6126	266	260
28073	254	161		10385	6126	266	260
24907	254	161		10385	6126	266	260
22667	254	161		10385	6126	266	260
26326	255	161		10385	6126	266	260
23754	255	160		10385	6126	266	260
23123	255	160		10385	6126	266	260
29186	255	160		10385	6126	266	260
29192	254	160		10385	6126	266	260
29190	254	168		10385	6126	266	260
29164	254	161		10385	6126	266	260
29164	254	161		10385	6126	266	260
29152	254	163		10385	6126	266	260
29152	254	161		10385	6126	266	260
29186	252	161		10385	6126	266	260
29041	250	160		10385	6126	266	260

18th preceding measurement ———

Immediately preceding measurement ———

Results from 18 measurements are displayed on a page. Decimals are eliminated. Results judged as "NG" are displayed in reverse video.

▲ :Previous page ▼ :Next page

LABEL#02 CHECK
Scn00 Cam0 Raw Unfrz W0123 4567 CAL OFF CARD --

- 1, 2, 3... 1. Press Help Key. A log of measurement results will be displayed. Scroll pages by using the the Up and Down Keys.
2. Press the Escape Key to return to the measurement screen.

4-8 System

Y. System

Items such as communications specifications and operations at the time of startup are set under the “Y. System” menu. Data set under that menu is called “system data,” and it is referenced in common by all scenes. System data can be saved and loaded to and from memory cards and devices connected via RS-232C. For details, refer to 4-9-4 Saving and Loading System Data.

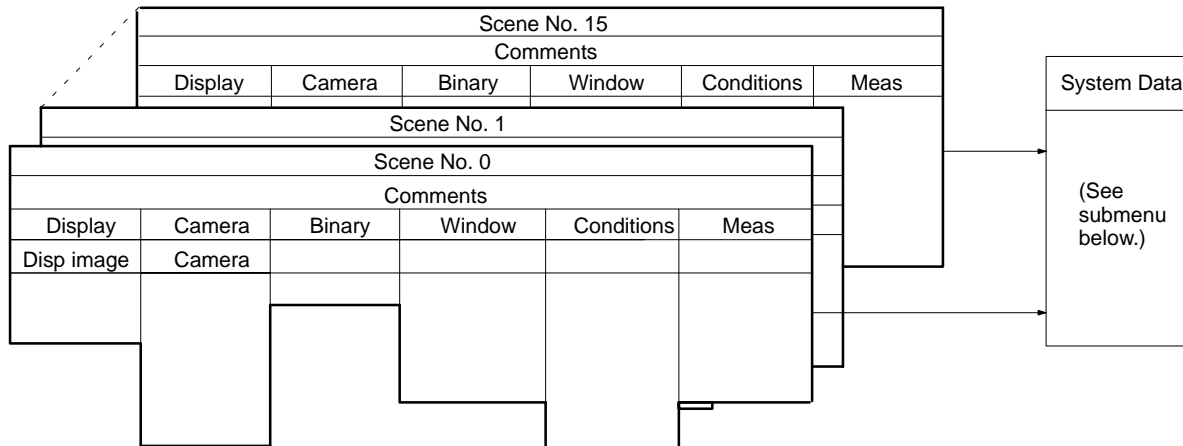

The operations accessed in the submenu shown below are explained on subsequent pages.

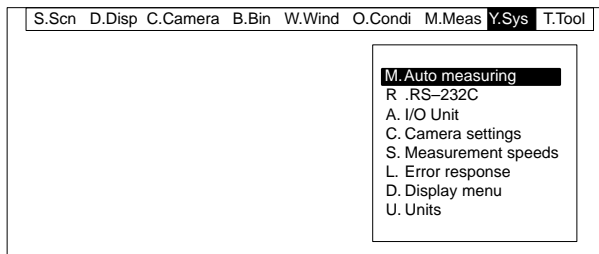

4-8-1 Automatic Measuring

A measurement screen can be displayed at the F200 startup, and measurements can be executed by measurement command input. This function is called "automatic measuring." It is used for actual operations after the scene data settings have been completed.

- 1, 2, 3...** 1. Select "M. Auto measuring."

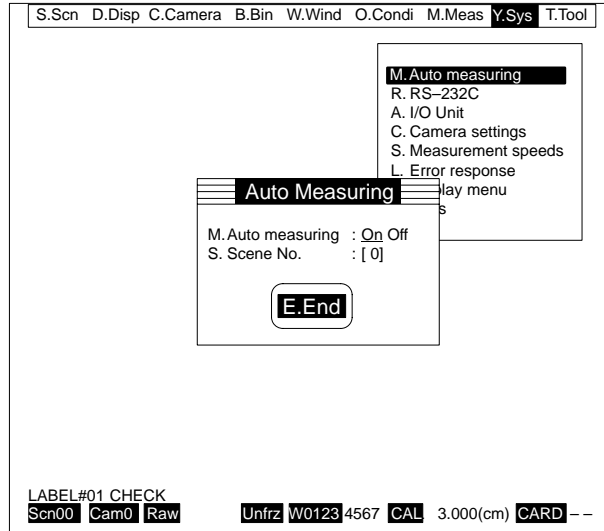

2. Set "M. Auto measuring" to "On."
3. Set "S. Scene No." to a number from 0 to 15.
4. Select "E. End." The measurement screen for the designated scene number will automatically be displayed at the next startup.

Disabling Automatic Measuring

While automatic measuring is set, it can be temporarily disabled. The settings for the "M. Auto measuring" menu are not cancelled, however, the measurement screen will again be displayed automatically at the next startup. This operation can only be executed by means of the console.

- 1, 2, 3...** 1. Turn on the power supply for the F200 while holding down the Escape Key. A message will be displayed asking for confirmation. (Continue holding the Escape Key until that message appears.)

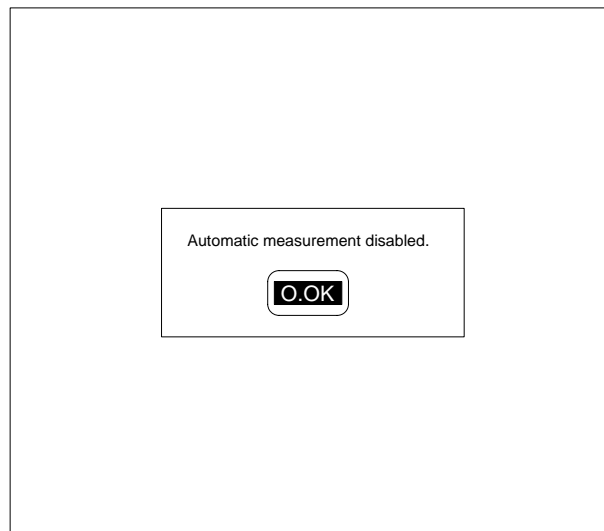

2. Select "O. OK." Automatic measuring will be temporarily disabled, and the basic menu will be displayed. (The scene number that was being displayed

just prior to the power supply being turned off will be displayed again here at startup.)

4-8-2 Setting RS-232C Communications Specifications

It is necessary to set RS-232C communications specifications in the following situations:

- When menu operations are executed via RS-232C.
- When commands are input via RS-232C.
- When judgement results and measured values are output via RS-232C.

In addition, when a command is input via RS-232C, special codes can be returned to confirm that the command has been received and executed. This is called "command response." When menu operations are executed via RS-232C, the command response function helps to ensure reliable operations by providing notice of F200 status.

Setting Communications Specifications

Communications specifications must be set for channels 0 and 1 respectively. The settings must match the devices that are connected for each channel.

Item	Settings
B. Baud rate	1200, 2400, 4800, 9600 (bps)
L. Data length	7 or 8 (bit)
P. Parity bit	None, Even, Odd
S. Stop bit	1 or 2 (bit)
D. Delimiter	CR, LF, CR + LF
F. Flow	<p>None, Xon/off, RS/CS</p> <p>Xon/off: Executes flow control by means of software.</p> <ul style="list-style-type: none"> • When loading, Xon/off is executed according to the F200's reception status. • When saving, data is transmitted according to the Xon/off status of the external device. <p>RS/CS: Executes flow control by means of hardware. Cable must be used that connects the RS and CS signals of the F200 and external devices.</p> <ul style="list-style-type: none"> • When saving, data is transmitted according to the CS signal from the external device.
T. Timeout	Input a number from 1 to 255, in units of 100 ms. If 0 is input, the timeout function will not be executed. (The timeout function is explained in more detail below.)

Timeout Function

When the timeout function has been set, the following errors may be generated:

- Xon/off: When loading, data is not transmitted from the external device within the timeout period. When saving, Xon does not occur at the external device within the timeout period.
- RS/CS: When loading, data is not transmitted from the external device within the timeout period. When saving, the CS signal does not turn ON at the external device within the timeout period.
- None: When loading, data is not transmitted from the external device within the timeout period.

Combinations of Settings

Settings for stop bits, data length, and parity bit can be combined as shown in the following table.

Stop bit	Data length	Parity bit
1 bit	7 bits	Odd
		Even
	8 bits	None
		Odd
2 bits	7 bits	Even
		Odd
	8 bits	None

Procedure

To set the communications specifications, follow the procedure outlined below.

- 1, 2, 3... 1. Select "RS-232C."

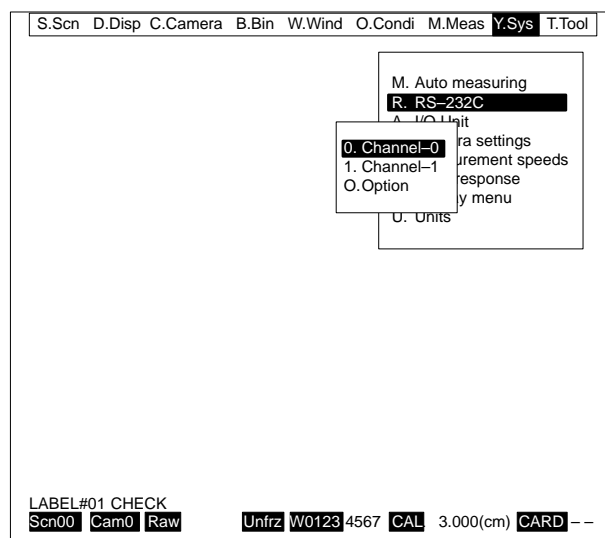

2. Select the channel for which the specifications are to be set. The screen for setting the communications specifications for that channel will be displayed.
 3. Set the specifications, and then select "E. End."

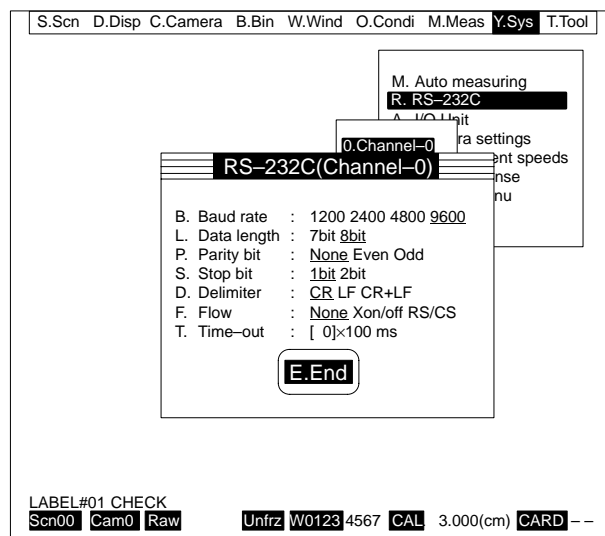

Using Command Response The command response function is set in common for channels 0 and 1. When a command is input via RS-232C, "ACK(\$06)" will be returned. The command will then be executed, and after it has been executed "EOT(\$04)" will be returned. For an example of using command response at an RS-232C device (reception based on Quick BASIC), refer to *Appendix C RS-232C Data Transmission Program Example*.

Example: Loading Scene Data at a Measurement Screen

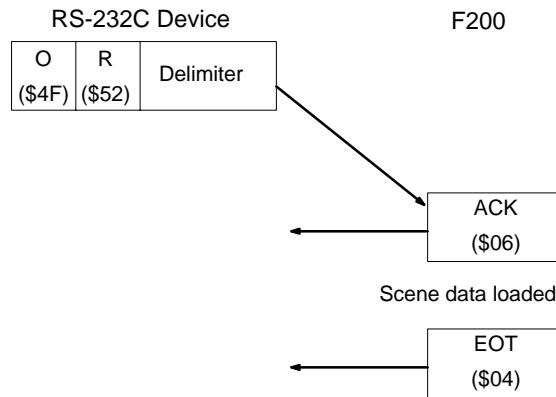

- 1, 2, 3...**
1. Select "RS-232C."
 2. Select "O. Option." The screen for setting the command response will be displayed.

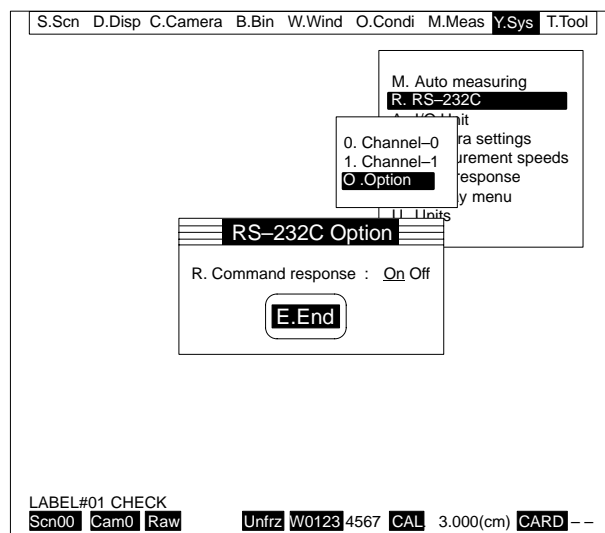

3. Set "R. Command response" to "On."

4-8-3 Setting Parallel Data Output Specifications

When outputting measured results to a Parallel I/O Unit or a Terminal Block Unit, it is necessary to set the output specifications for the parallel data. The output timing is as shown in the following timing charts.

Output Timing (Without Handshaking)

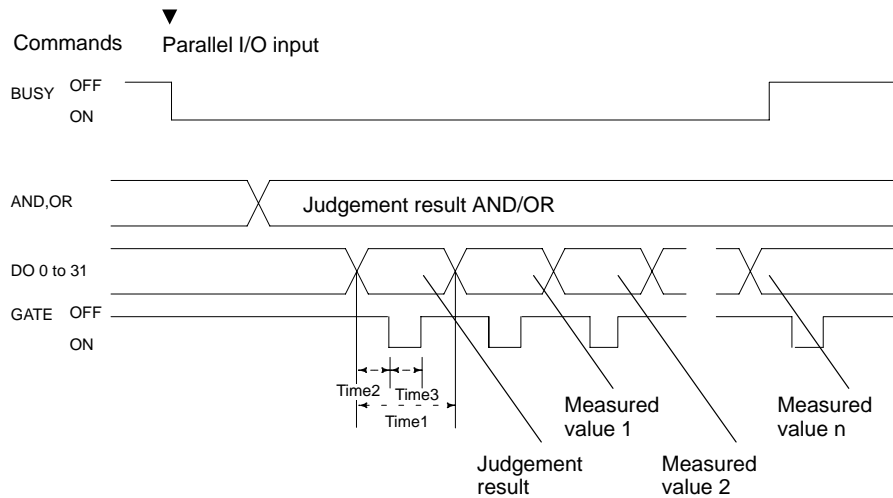

Terminal	Function
BUSY	The BUSY signal turns ON during command processing or while scene data (such as the binary level or criteria) is being changed. While the BUSY signal is ON, any commands that are input will be ignored. Commands from the console or via RS-232C, however, will be held in the buffer and processed as soon as the BUSY signal turns OFF.
AND, OR	Logic operations are carried out and output for the judgement results of all output expressions. For details concerning output methods, refer to 4-7-2 <i>Outputting Measurement Results</i> .
DO0 to DO31	Data is output at these terminals. For details concerning formats, refer to 4-7-2 <i>Outputting Measurement Results</i> .
GATE	This terminal is used to control the timing for obtaining data. Set the output period, the delay time, and the output time so that the GATE signal will be turned on while data can be reliably obtained. <ul style="list-style-type: none"> Time 1 (output period): Sets the cycle time for outputting data. Time 2 (delay time): Sets the time until the GATE signal turns ON after data is output. Time 3 (output time): Sets the time that the GATE signal is turned ON for. Obtain data while the GATE signal is turned ON.

Output Timing (With Handshaking)

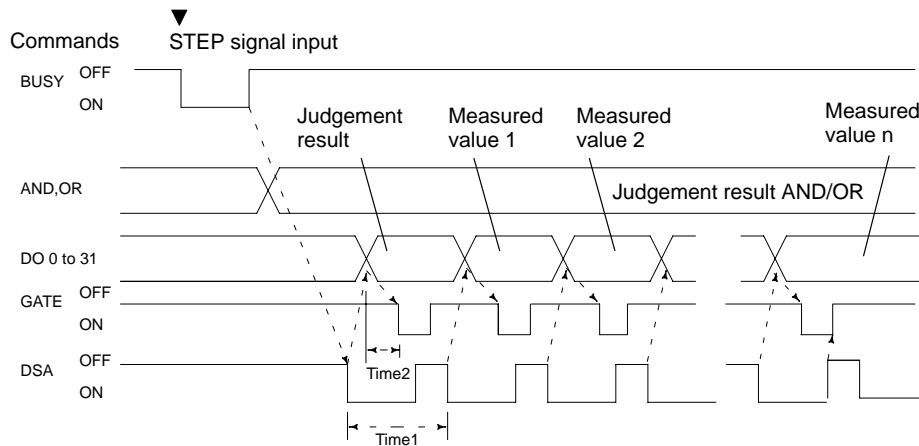

Terminal	Function
BUSY	The BUSY signal turns ON during command processing or while scene data (such as the binary level or criteria) is being changed. While the BUSY signal is ON, any commands that are input will be ignored. Commands from the console or via RS-232C, however, will be held in the buffer and processed as soon as the BUSY signal turns OFF.
AND, OR	Logic operations are carried out and output for the judgement results of all output expressions. For details concerning output methods, refer to 4-7-2 <i>Outputting Measurement Results</i> .
DO0 to DO31	Data is output at these terminals. For details concerning formats, refer to 4-7-2 <i>Outputting Measurement Results</i> .
GATE	This terminal is used to control the timing for obtaining data. Set the delay time so that the GATE signal will be turned on while data can be reliably obtained. Time 2 (delay time): Sets the time until the GATE signal turns ON after data is output. Obtain data while the GATE signal is turned ON.
DSA	Requests the next data output, from an external device. At the external device, turn it ON when the next data can be received. At the F200, data will not be output until the DSA signal turns from OFF to ON (i.e., until the leading edge is detected). Data cannot be requested while the BUSY signal is ON. Be sure that the BUSY signal is turned OFF before the DSA signal is turned ON. If the timeout function is set, an error will be generated if the DSA signal does not turn from OFF to ON within the timeout period. Time 1 (timeout period): Sets the time from when a DSA signal turns ON until the next DSA signal turns ON.

Setting Output Specifications

Terminal	Function
F. Format	Binary, BCD
H. Handshake	Yes, No
T. Time-out	Make this setting, in units of 100 ms, when “Handshake” is set to “Yes.” The range is 1 to 65,535. If “0” is input, the timeout function will not be executed. The initial (default) value is 100.
C. Output period	Input a number within a range of 3 to 65,535, in units of 100 μs. Set a number greater than the sum of the delay time plus the output time. The initial (default) value is 100.
D. Delay	Input a number within a range of 1 to 65,535, in units of 100 μs. The initial (default) value is 10.
O. Output time	Input a number within a range of 1 to 65,535, in units of 100 μs. The initial (default) value is 50.

Procedure

To set the output format, follow the procedure outlined below.

- 1, 2, 3... 1. Select “A. I/O Unit” The screen for setting the output specifications will be displayed.
2. Set the output format, and then select “E. End.”

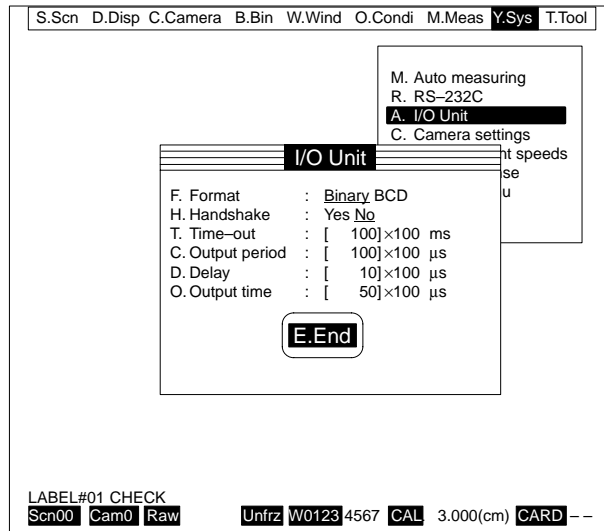

4-8-4 Setting Specifications for Connected Cameras

Specifications must be set for connected cameras and Camera I/F Units. The initial values will be the camera and Camera I/F Unit specifications that were confirmed at the initial screen. Therefore, if those specifications are checked and found to be OK, there is nothing more that needs to be done.

If the cameras and Camera I/F Units actually connected are different from the ones indicated in the settings, then images cannot be taken correctly. Be sure to set the camera and Camera I/F Unit specifications before setting the scene data.

Item	Settings	
U. Camera I/F Unit	The Camera I/F Units that are currently connected are automatically recognized, and their model numbers are displayed. Select the model number (F300-A20RS/A21RS) of the mounted Camera I/F Unit only when a Shutter Simultaneously Camera I/F Unit is used.	
C. Camera	A list of the cameras that can be used with the currently mounted Camera I/F Unit will be displayed. Select the camera that is to be used.	
	Camera I/F Unit	Camera
	F300-A20 Normal	F200-S, F300-S
	F300-A20S Normal Simultaneously	F300-S
	F300-A20R Shutter	PJLG-50/55/60-Z
	F300-A20RS Shutter Simultaneously	PJLG-50/55/60-Z
	F300-A21RS Shutter Simultaneously	PJLG-70-Z
Y. Camera synchronization	The methods for camera synchronization are displayed automatically for the cameras that are being used.	
S. Strobe disable, start	The beginning value for strobe flash disable is automatically displayed for the cameras that are being used.	
G. Strobe disable, end	The end value for strobe flash disable is automatically displayed for the cameras that are being used.	

Note Proper operation cannot be assured if cameras other than the ones listed in the preceding table are used. If you wish to use a camera other than those, please consult one of the OMRON sales offices listed at the back of this manual. Of the models listed in the table, the F300- A21RS Shutter Simultaneously Camera I/F Unit and the PJLG-50/60/70-Z Shutter Camera are not available at this time. We apologize for the inconvenience.

Procedure

To set the camera specifications, follow the procedure outlined below.

- 1, 2, 3... 1. Select "C. Camera settings." The screen for setting the camera specifications will be displayed.
2. Set the specifications, and then select "E. End."

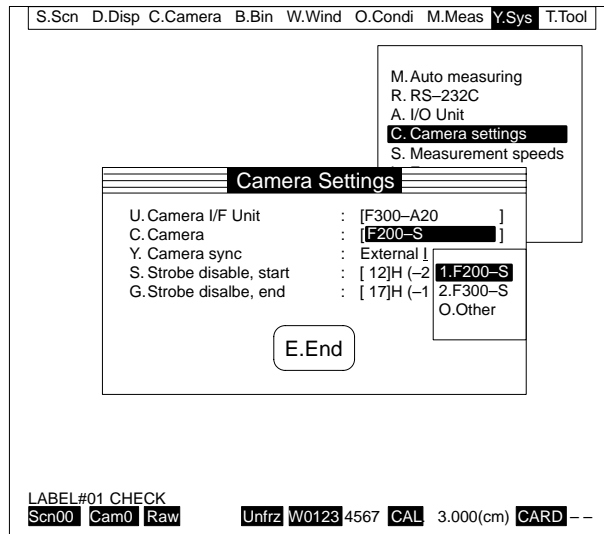

4-8-5 Setting Measurement Speeds

Speeds can be selected for processing measurements and position displacement compensation. Ordinarily, processing for a single camera takes 33.3 ms, but that can be reduced to 16.7 ms by changing the resolution for measurement images. Lowering the vertical resolution does not affect the accuracy of inspections, and greater inspection and positioning efficiency can be achieved by selecting "Fast."

Item	Settings
P. Position compensation	Select either "Normal" or "Fast" as the speed for position displacement compensation. ("Normal" cannot be selected here if "Fast" is selected for measurement.) Normal: Processes camera images with a resolution of 512 (H) x 484 (V) at 33.3 ms. Fast: Processes camera images with a resolution of 512 (H) x 242 (V) at 16.7 ms.
M. Measurement	Select either "Normal" or "Fast" as the speed for measurement. ("Fast" cannot be selected here if "Normal" is selected for position displacement compensation.) Normal: Processes camera images with a resolution of 512 (H) x 484 (V) at 33.3 ms. Fast: Processes camera images with a resolution of 512 (H) x 242 (V) at 16.7 ms.

- Note**
1. The measurement processing time under the currently set conditions can be displayed. For details, refer to 4-6-6 *Checking Data Set by O. Conditions*.
 2. If the resolution is changed in order to change measurement speed, it may affect the measurement image. When executing position displacement compensation and judgements, be sure to save the standards and set the criteria after changing the measurement speed. For details, refer to 4-6-2 *Setting Criteria for Judging Displacement*, 4-6-4 *Setting Output Expression Criteria*, and 4-6-5 *Saving Reference Images*.

Procedure

To set the measurement speeds, follow the procedure outlined below.

- 1, 2, 3... 1. Select "S. Measurement speeds." The screen for setting the measurement speeds will be displayed.
2. Set the measurement speeds, and then select "E. End."

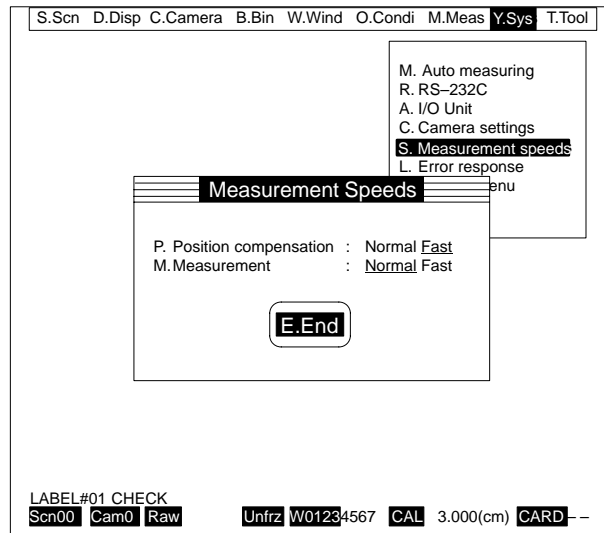

4-8-6 Selecting the Error Output Method

Errors that occur at measurement screens can be detected and output. The methods that can be selected for outputting those errors are explained here. The errors are output after the measurement processing has been executed. The error types are displayed on the video monitor, making it easy to discover and correct the causes of the errors.

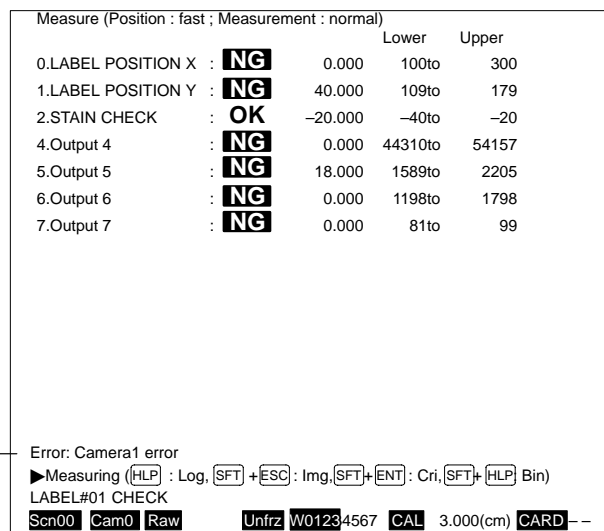

The error is displayed here. —

Error Types and Causes The causes of the errors shown in the following table are detected, and the errors are output.

Type of error	Probable cause
C. Camera error	A camera that is to be used for measurement is not connected. The number of the camera that is not connected will be displayed at the video monitor.
T. Strobe error	A flash error signal is ON for a strobe that is used during measurement.
M. Position error	The area is measured as "0" in a window used for position displacement compensation. The result obtained when measuring the amount of position displacement is judged as "NG."
R. RS-232C error	One of the following errors occurs while judgement results or measured values are being output via RS-232C, or while scene data or system data is being saved or loaded: <ul style="list-style-type: none"> • A time-out error is generated. • Some data was not retrieved and normal loading was not possible. • The data is incorrect, and cannot be properly loaded. • The RS-232C I/F Unit is not properly connected.
P. I/O Unit error	One of the following errors occurs while judgement results or measured values are being output to a Terminal Block Unit or a Parallel I/O Unit: <ul style="list-style-type: none"> • A time-out error is generated. • The Terminal Block Unit or the Parallel I/O Unit is not properly connected.
A. Memory card error	One of the following errors occurs while judgement results or measured values are being output to a memory card, or while scene data or system data is being saved or loaded: <ul style="list-style-type: none"> • The memory card cover is open. • No memory card is installed. • The memory card is not initialized. • The memory card has no available capacity. • The memory card is write-protected.
L. Load error	The designated file does not exist for loading system data, or one of the following errors occurs while scene data is being loaded: <ul style="list-style-type: none"> • There are more than 255 windows, so some of them cannot be loaded. • The area for saving windows has been exceeded, so some windows cannot be loaded. • The designated file does not exist.
S. Save error	One of the following errors occurs while system or scene data is being saved: <ul style="list-style-type: none"> • There is no available capacity on the memory card. • The filename is invalid. • The same filename already exists.

Output Methods There are four methods for outputting errors, as shown in the following table, and any one of them can be selected.

Method	Function
Ignore (default)	Even if an error occurs, it is not output. The measurement results are output, and measurement continues.
Message	An error message is displayed in the comment line at the video monitor. If several errors occur simultaneously, all of the error types are displayed. The measurement results are output, and measurement continues.
Signal	An error message is displayed in the comment line at the video monitor. The ERROR indicator on the Power Supply Unit lights, and the error signal turns ON. The measurement results are output, and measurement continues.
Stop	An error message is displayed in the comment line at the video monitor. The ERROR indicator on the Power Supply Unit lights, and the error signal turns ON. The measurement results are not output, and the F200 operation stops.

Clearing the Error Output The methods for clearing error outputs vary depending on the error output method used.

Message or Terminal

First remove the cause of the error. If the cause has been successfully removed, then the error output will be automatically cleared with the next measurement.

Stop

First remove the cause of the error. Then power up again and restart the F200 System. It is possible to restart the F200 by turning ON the RESET signal of the Parallel I/O Unit or Terminal Block or by inputting the reset command from the console.

Procedure

To set the output method, follow the procedure outlined below.

- 1, 2, 3... 1. Select "L. Error response." The screen for setting the output method will be displayed.
2. Set the output method, and then select "E. End."

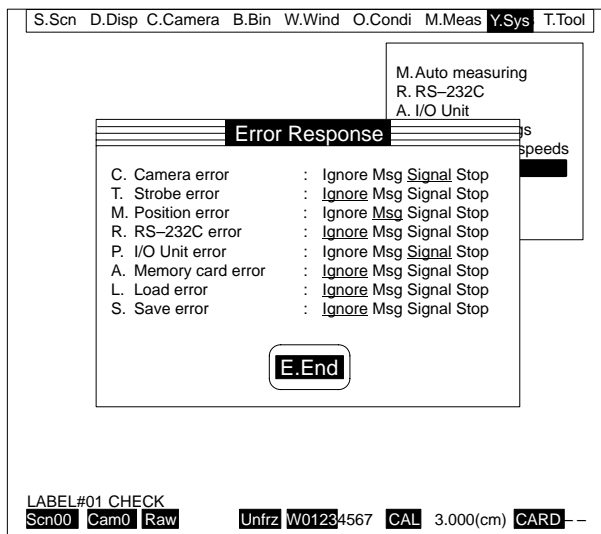

4-8-7 Selecting the Menu Display Method

Select the method for displaying menus.

Item	Settings
H. Start-up display	Select whether the initial screen is to be displayed at start-up. The default setting is for the initial screen to be displayed (i.e., set to "On.") If this is set to "Off," the initial screen will not be displayed and the cameras and Camera I/F Units cannot be confirmed. Before setting the scene data, check to be sure that the settings are made correctly for the connected cameras and Camera I/F Units. For details, refer to 4-8-4 <i>Setting Specifications for Connected Cameras</i> .
A. One-touch key display	Select whether one-touch keys are to be displayed. Even if the display is cleared, menu operations are possible by means of one-touch keys. The default setting is for the one-touch keys to be displayed (i.e., set to "On.")
K. Console beep	Select whether a beep is to sound when keys are input from the console. The default setting is for the beep to not sound (i.e., set to "Off.")

Procedure

To set the menu display method, follow the procedure outlined below.

- 1, 2, 3... 1. Select "D. Display menu." The screen for setting the menu display method will be displayed.

2. Set the menu display method, and then select “E. End.”

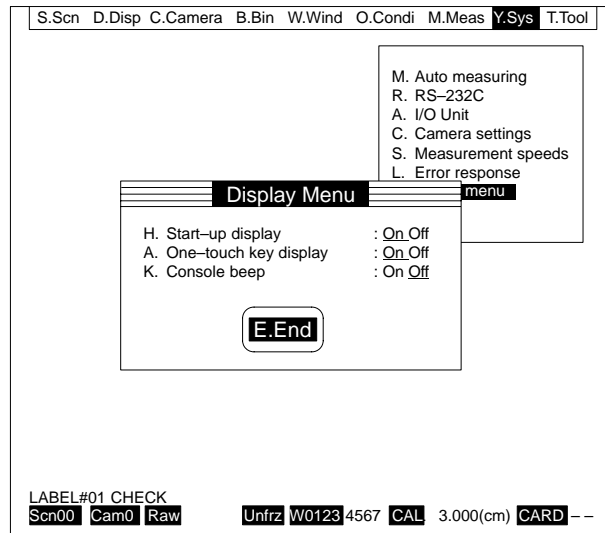

4-8-8 Checking Connected Units

The names and model numbers of Units (except for F200-P Power Supply Units and F300-FM MMI Units) mounted to IMP Unit slots can be displayed.

- 1, 2, 3...** 1. Select “U. Connected Units.” The names and model numbers of the currently connected Units will be displayed for slots 0 to 2, beginning with the slot nearest the Power Supply Unit.

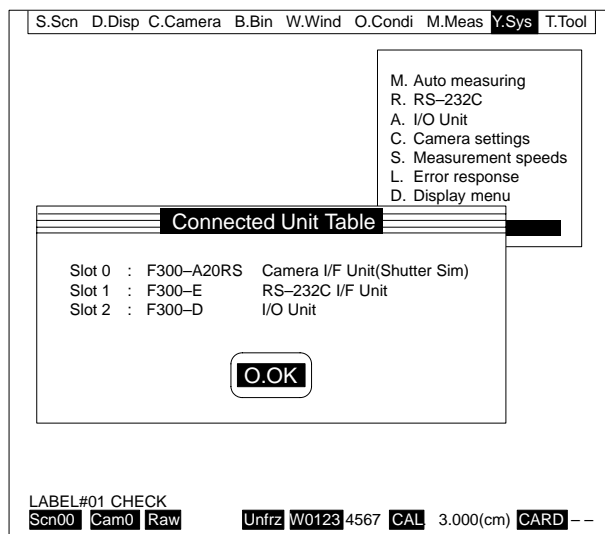

2. Select “O. OK.”

Caution Do not mount or dismount Units while the power is turned on for the F200.

4-9 Tools

T. Tool

The “T. Tool” menu provides tools to support maintenance operations such as displaying special graphs, saving and loading scene data and system data, and initializing and editing memory cards. The operations accessed in the submenu shown below are explained on subsequent pages.

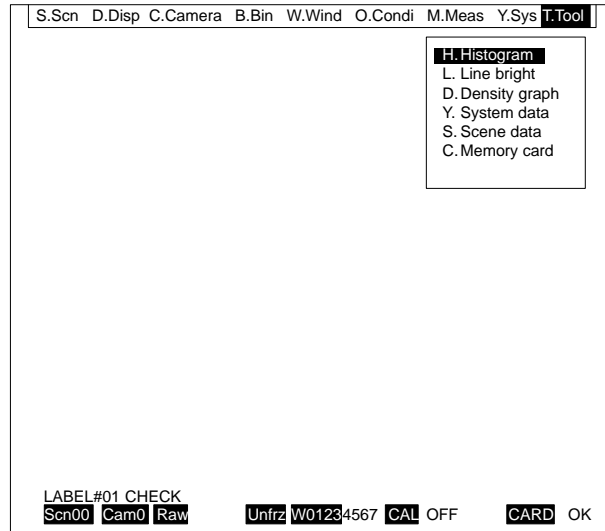

4-9-1 Histograms

A histogram is a graph which shows the distribution of pixels with respect to image density (numbered from 0 to 255). A histogram can be displayed for any area. When image filtering is set, histograms will be displayed for the image after filtering.

The upper and lower limits for the binary level can be set while observing a histogram. For details, refer to *4-4-2 Setting the Binary Level*.

How to Read a Histogram

Along the vertical axis, the number of all pixels (247,808) is taken as 100%, and the number of pixels for each density is shown as a percentage.

The density (0 to 255) is displayed along the horizontal axis.

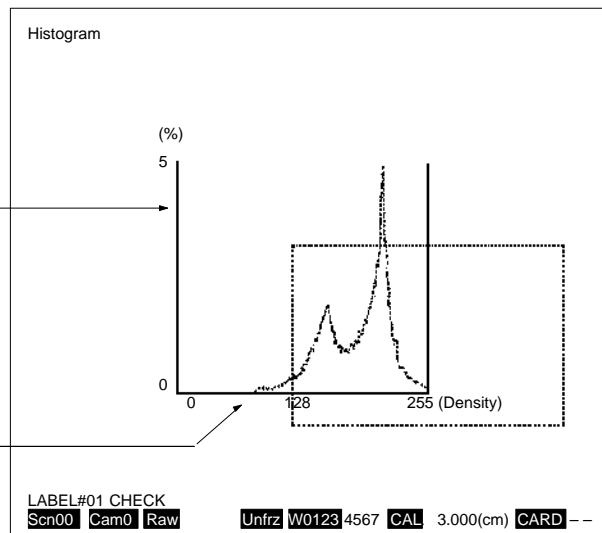

When Two Cameras are Used

A histogram can be displayed with respect to the camera that is currently displayed. Before displaying a histogram, select the number of the camera for which the histogram is to be displayed. For details, refer to *4-3-1 Selecting Cameras*.

Procedure

To display a histogram, follow the procedure outlined below.

- 1, 2, 3... 1. Select "H. Histogram."
2. Designate a rectangle for displaying the histogram by specifying the points for opposite corners. Move the cursor to the points and press the Enter Key. The histogram will then be displayed in that rectangle.

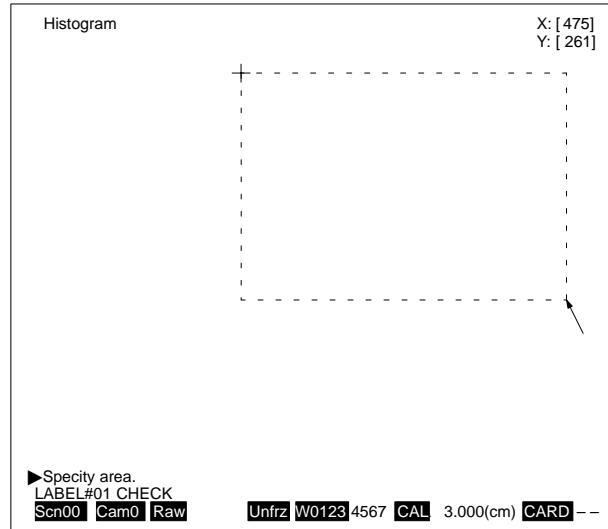

3. Press the Enter Key or the Escape Key.

4-9-2 Line Brightness

The image density distribution of any one line in the vertical direction and that in the horizontal direction can be displayed simultaneously. When image filtering is set, the line brightness will be displayed for the image after filtering.

The upper and lower limits for the binary level can be set while observing line brightness. For details, refer to 4-4-2 *Setting the Binary Level*.

How to Read a Line Brightness Diagram

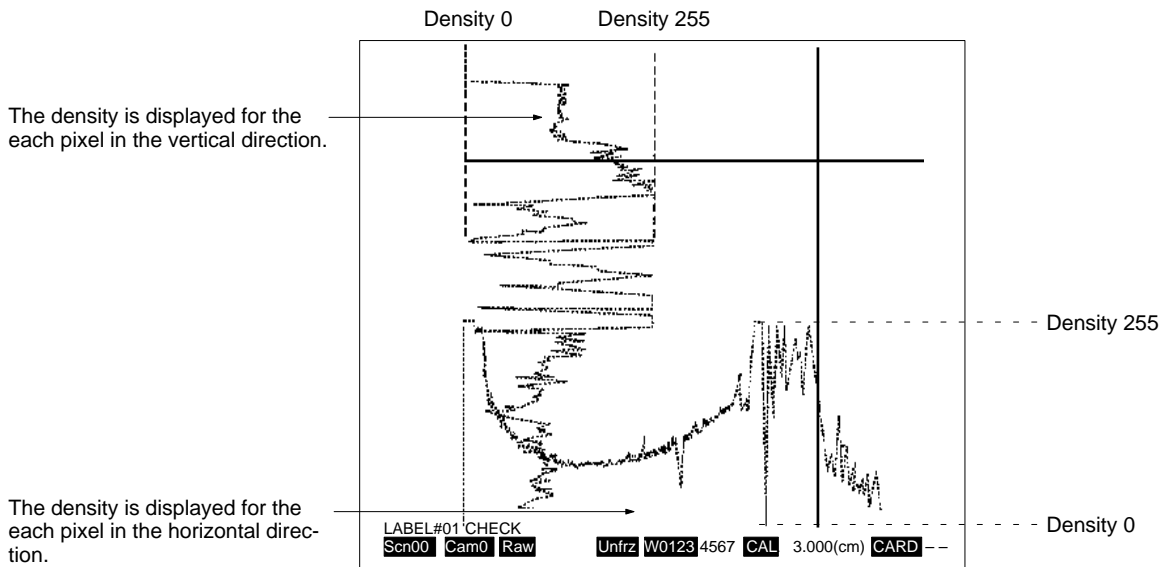

When Two Cameras are Used

A line brightness diagram can be displayed with respect to the camera that is currently displayed. Before displaying line brightness, select the number of the camera for which it is to be displayed. For details, refer to 4-3-1 *Selecting Cameras*.

Procedure

To display line brightness, follow the procedure outlined below.

- 1, 2, 3...**
1. Select "L. Line bright."
 2. Dotted lines will be displayed in the vertical and horizontal directions. Use the direction keys to move the lines to the desired position, and then press the Enter Key. The line brightness diagram for that position will be displayed.

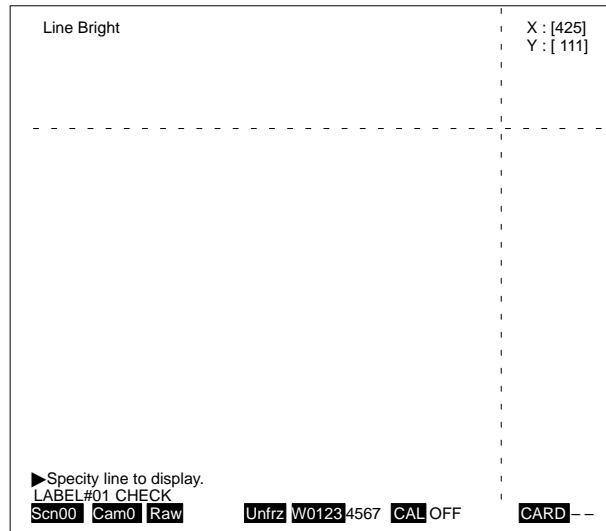

3. Press the Enter Key or the Escape Key.

4-9-3 Density Graph

A density graph is a three-dimensional illustration which shows the light density distribution for an entire image. When image filtering is set, the density graph will be displayed for the image after filtering.

How to Read a Density Graph

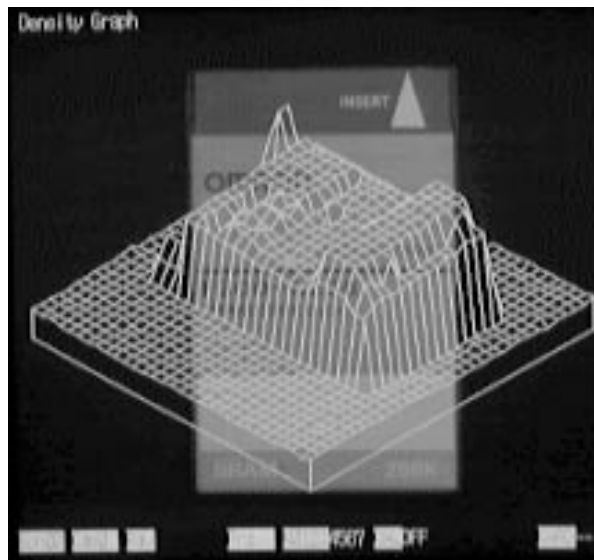

When Two Cameras are Used

A density graph can be displayed with respect to the camera that is currently displayed. Before displaying a density graph, select the number of the camera for which it is to be displayed. For details, refer to 4-3-1 *Selecting Cameras*.

Procedure

To display a density graph, follow the procedure outlined below.

- 1, 2, 3... 1. Select "D. Density graph."
2. Press the Enter Key. The density graph will be displayed.

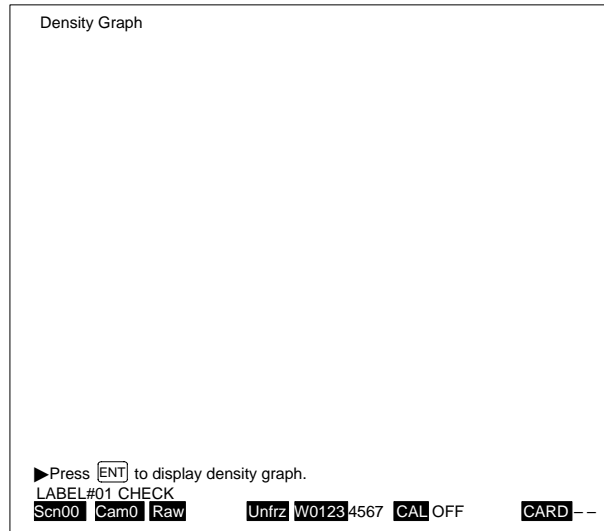

3. Press the Enter Key or the Escape Key.

4-9-4 Saving and Loading System Data

System data can be loaded or saved to and from memory cards or devices connected via RS-232C.

Loading from a Memory Card

System data that was previously saved to a memory card can be loaded to the F200. First install the memory card to which the system data was saved, and then follow the procedure outlined below.

- 1, 2, 3... 1. Select "Y. System data."
2. Select "L. Load."

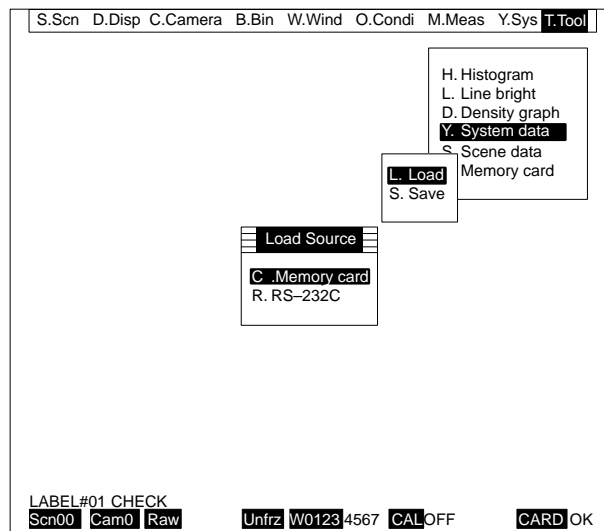

3. Select "C. Memory card." A list of the system data on the memory card will be displayed.

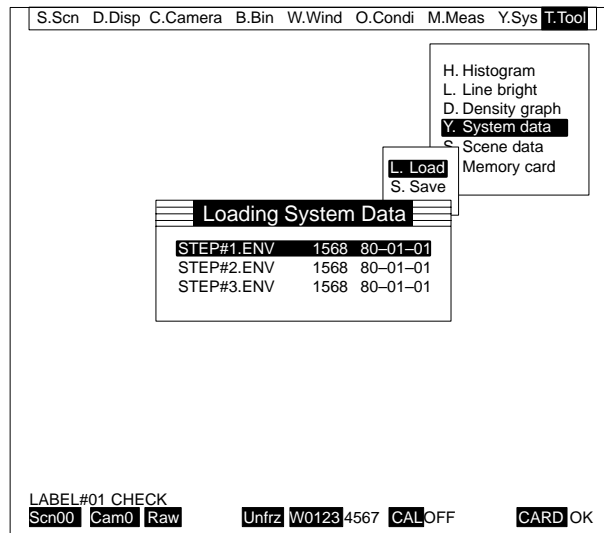

4. Select the name of the file that is to be loaded. A confirmation screen will be displayed.
5. Select "X. Execute." The data will be loaded to the F200. When the loading operation is complete, a confirmation message will be displayed. Check the settings of the camera and Camera I/F Unit. If the settings do not match the camera and Camera I/F Unit that are actually connected, then images cannot be taken correctly. If the settings are wrong, correct them. For details, refer to *4-8-4 Setting Specifications for Connected Cameras*.

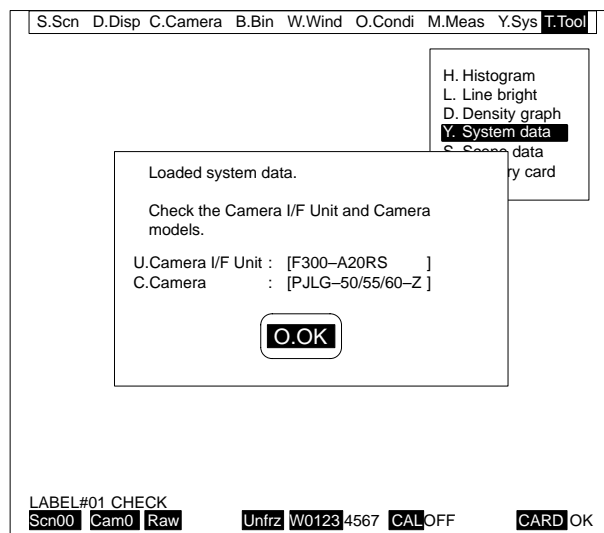

6. Select "O. OK."

Loading via RS-232C

Data that has been previously saved via RS-232C can be loaded to the F200. For this it is necessary to set the communications specifications. For details, refer to *4-8-2 Setting RS-232C Communications Specifications*. In addition, an example program is provided in *Appendix C RS-232C Data Transmission Program Example*.

Channel 0 must be used for loading system data. It cannot be loaded using channel 1.

- 1, 2, 3... 1. Select "Y. System data."
2. Select "L. Load."
3. Select "R. RS-232C." A confirmation message will be displayed.

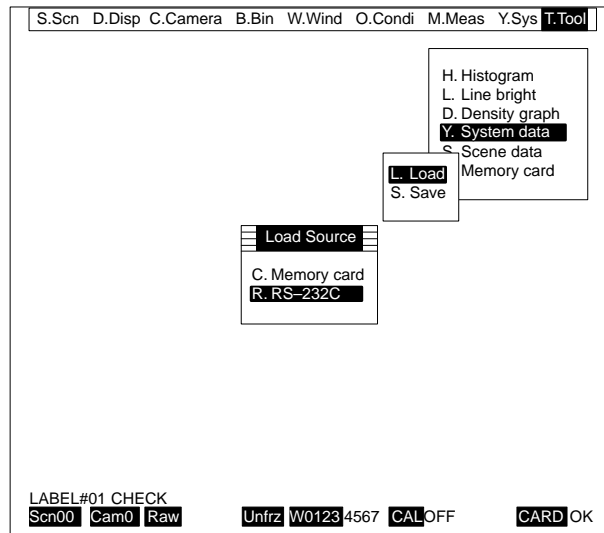

4. Select "X. Execute." The F200 will prepare to receive the data.
5. Transmit the data from the external device. The data will be loaded to the F200.

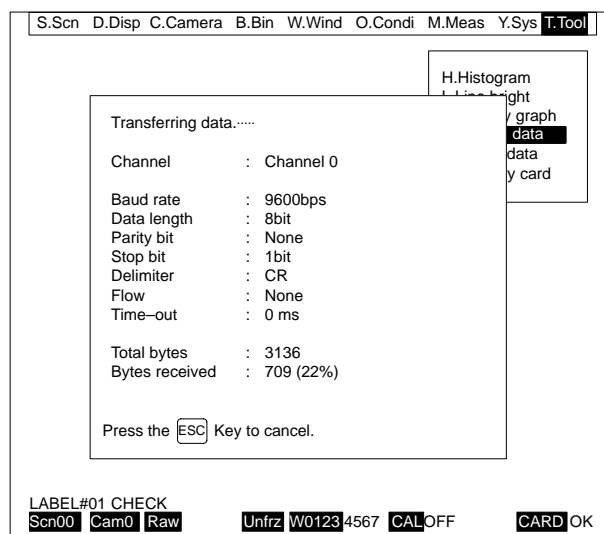

When the loading operation is complete, a confirmation message will be displayed. Check the settings of the camera and Camera I/F Unit. If the settings do not match the camera and Camera I/F Unit that are actually connected, then images cannot be taken correctly. If the settings are wrong, correct

them. For details, refer to *4-8-4 Setting Specifications for Connected Cameras*.

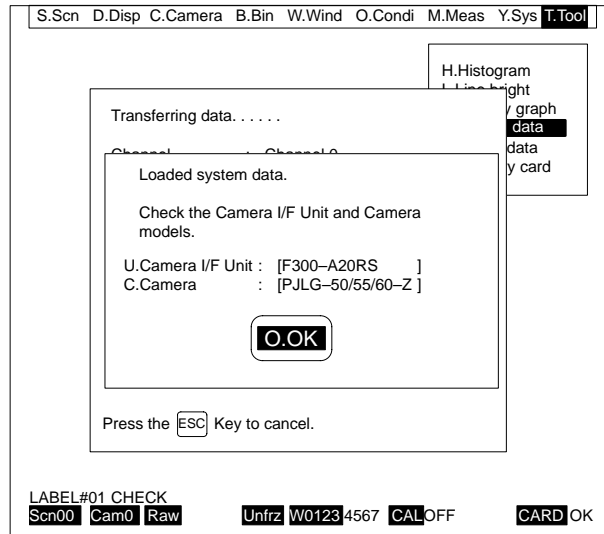

6. Select "O. OK."

Saving to a Memory Card

System data can be saved to a memory card. The extension ".ENV" will be automatically added to the name of the file that is saved. When a memory card is to be used for the first time after being purchased, it must first be initialized. For instructions, refer to *4-9-6 Initializing and Editing Memory Cards*.

- 1, 2, 3...**
1. Select "Y. System data."
 2. Select "S. Save."
 3. Select "C. Memory card."

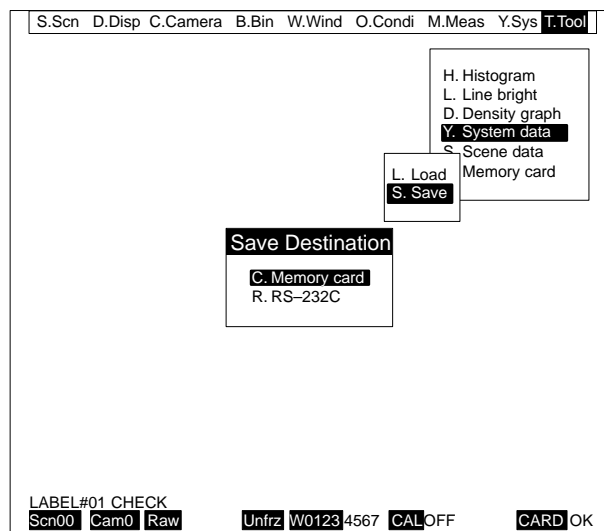

4. Enter the filename.

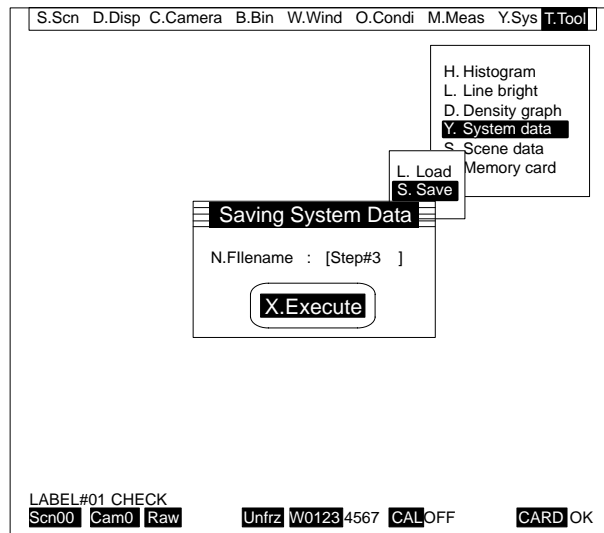

5. Select "X. Execute." A confirmation message will be displayed.
6. Select "X. Execute" again. When the save operation is complete, another confirmation message will be displayed.
7. Select "O. OK."

Saving via RS-232C

System data can be saved to a device connected via RS-232C. For this it is necessary to set the communications specifications. For details, refer to *4-8-2 Setting RS-232C Communications Specifications*. In addition, an example program is provided in *Appendix C RS-232C Data Transmission Program Example*.

Channel 0 must be used for saving system data. It cannot be saved using channel 1.

- 1, 2, 3...**
1. Select "Y. System data."
 2. Select "S. Save."
 3. Select "R. RS-232C." A confirmation message will be displayed.

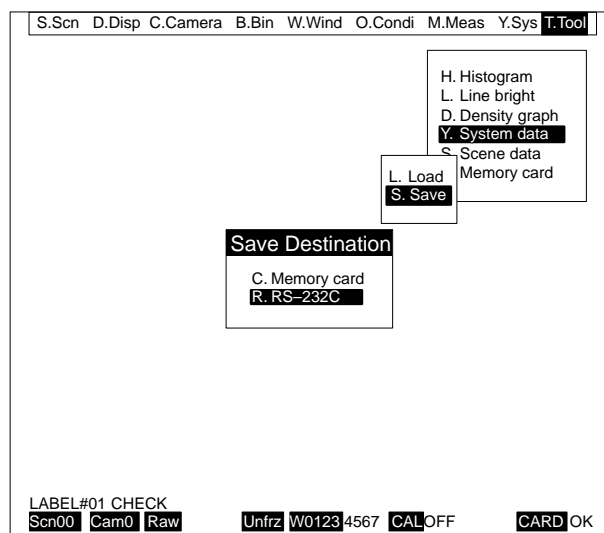

4. Select "X. Execute." When the save operation is complete, another confirmation message will be displayed.

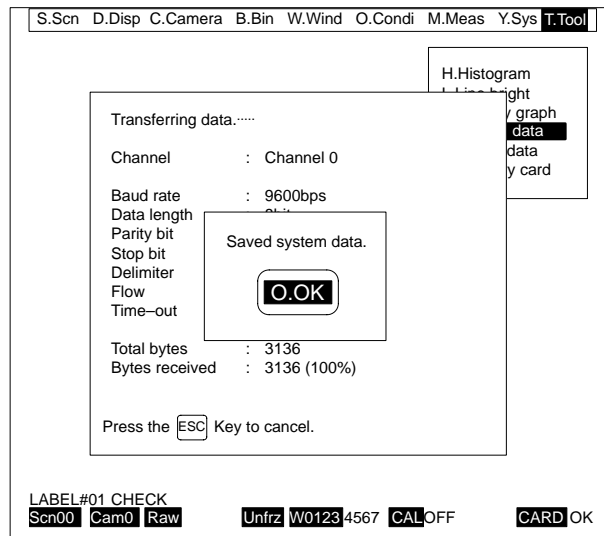

5. Select "O. OK."

4-9-5 Saving and Loading Scene Data

Scene data can be loaded or saved to and from memory cards or devices connected via RS-232C.

Loading from a Memory Card

Scene data that was previously saved to a memory card can be loaded to the F200. First install the memory card to which the scene data was saved, and then follow the procedure outlined below.

- 1, 2, 3... 1. Select "S. Scene data."
2. Select "L. Load."

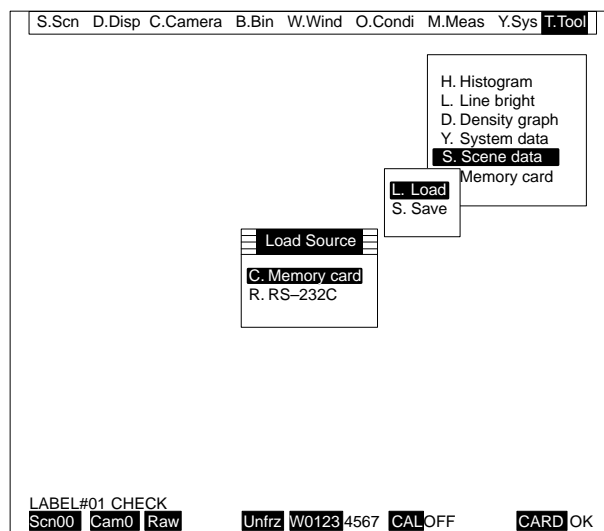

3. Select "C. Memory card." A list of the scene data on the memory card will be displayed.

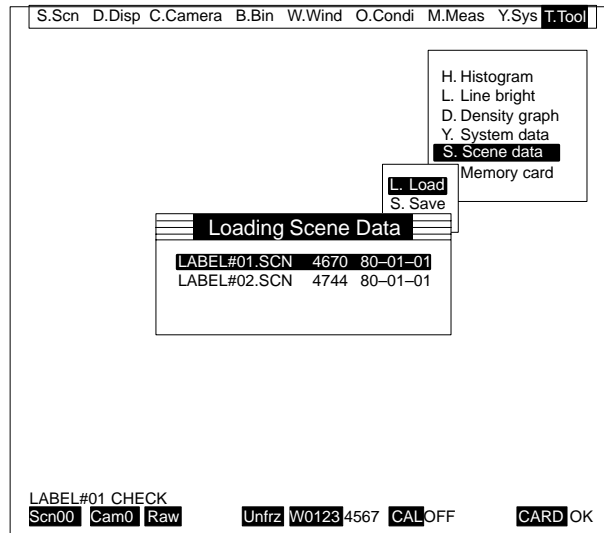

4. Select the name of the file that is to be loaded. If selecting a file that was saved individually, then specify the scene number that is to be loaded. If selecting a file that was saved as a group, a confirmation screen will be displayed.
5. Select "X. Execute." The data will be loaded to the F200. When the loading operation is complete, a confirmation message will be displayed.
6. Select "O. OK."

Loading via RS-232C

Data that has been previously saved via RS-232C can be loaded to the F200. Also, the data can be loaded to the scene numbers that were used when the data was saved. For this it is necessary to set the communications specifications. For details, refer to *4-8-2 Setting RS-232C Communications Specifications*. In addition, an example program is provided in *Appendix C RS-232C Data Transmission Program Example*.

Channel 0 must be used for loading scene data. It cannot be loaded using channel 1.

- 1, 2, 3...
 1. Select "S. Scene data."
 2. Select "L. Load."
 3. Select "R. RS-232C." A confirmation message will be displayed.

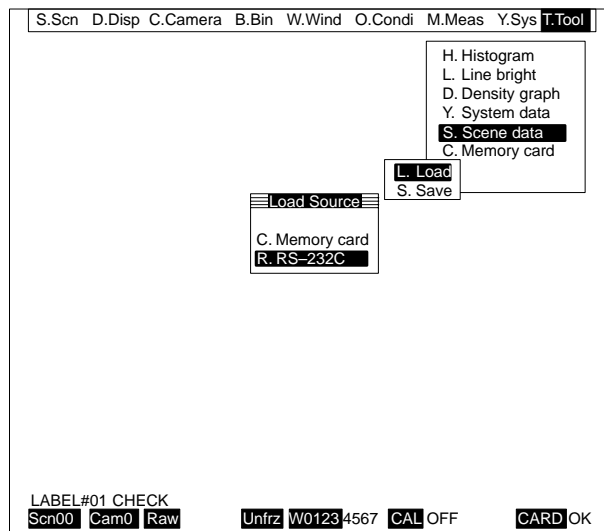

4. Select "X. Execute." The F200 will prepare to receive the data.
5. Transmit the data from the external device. The data will be loaded to the F200.

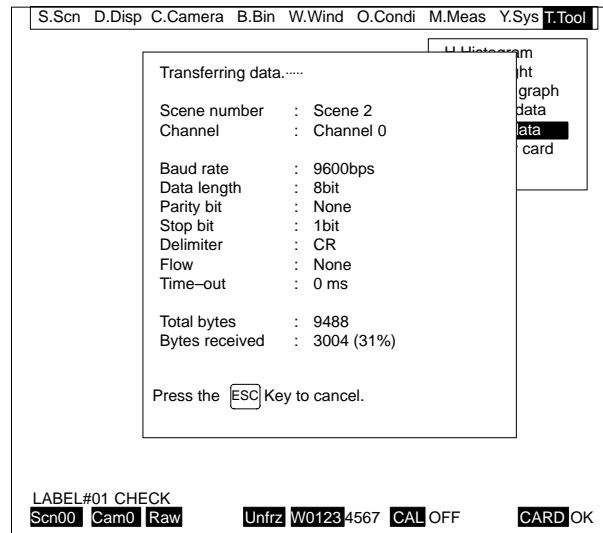

When the loading operation is complete, a confirmation message will be displayed.

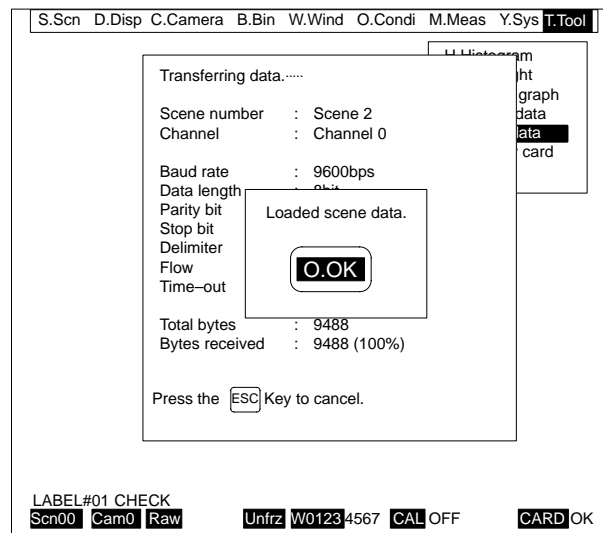

6. Select "O. OK."

Saving to a Memory Card

Scene data can be saved to a memory card. When saving scenes one by one, select "Individual." When saving all of the scene data on scenes 0 to 15, select "All." The extension ".SCN" will be automatically added to the name of the file that is saved. When a memory card is to be used for the first time after being purchased, it must first be initialized. For instructions, refer to 4-9-6 *Initializing and Editing Memory Cards*.

- 1, 2, 3...**
1. Select "S. Scene data."
 2. Select "S. Save."
 3. Select "C. Memory card."

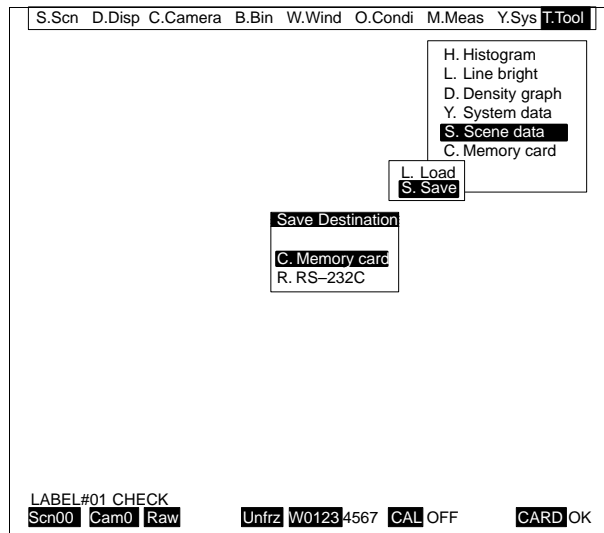

4. Select the method for saving the scene data. If selecting "Individual," then enter the number of the scene which is to be saved. The scene data from the designated scene will be saved.
5. Enter the filename.

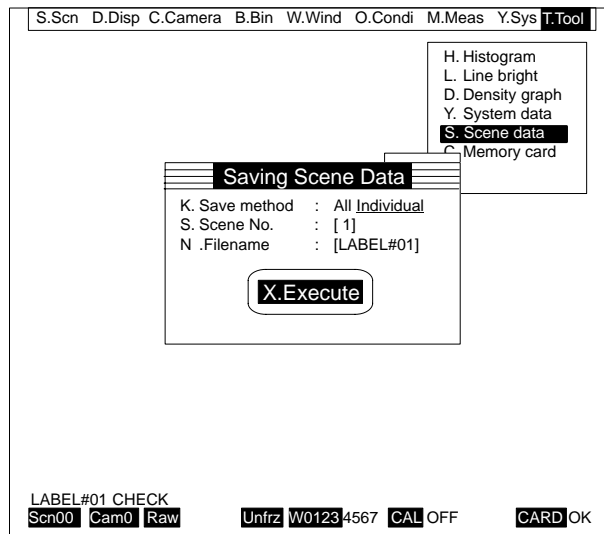

6. Select "X. Execute." A confirmation message will be displayed.
7. Select "X. Execute" again. When the save operation is complete, another confirmation message will be displayed.
8. Select "O. OK."

Saving via RS-232C

Scene data can be saved to a device connected via RS-232C. It is possible to save a number of scenes by selecting the start scene number and completion scene number of the scenes to be saved. For this it is necessary to set the communications specifications. For details, refer to *4-8-2 Setting RS-232C Communications Specifications*. In addition, an example program is provided in *Appendix C RS-232C Data Transmission Program Example*.

Channel 0 must be used for saving scene data. It cannot be saved using channel 1.

- 1, 2, 3...**
1. Select "S. Scene data."
 2. Select "S. Save."
 3. Select "R. RS-232C."

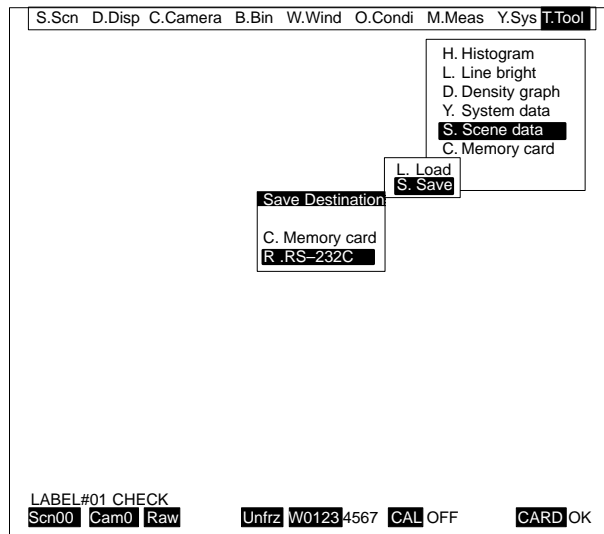

4. Set the beginning and ending scene numbers that are to be saved. The beginning scene number must be smaller or equal to the ending scene number.

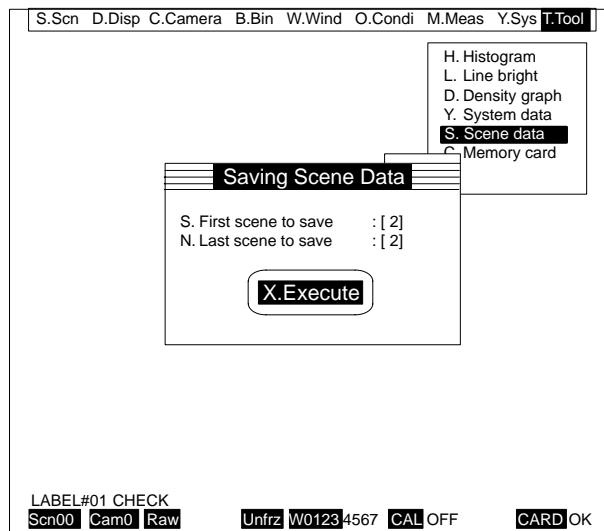

5. Select "X. Execute." When the save operation is complete, a confirmation message will be displayed.

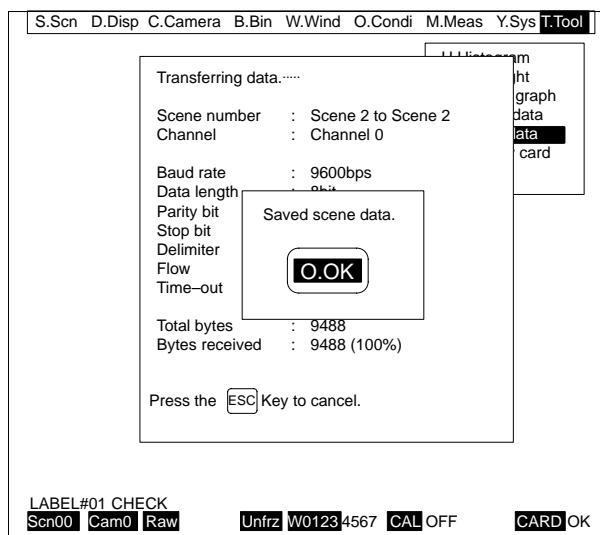

4-9-6 Initializing and Editing Memory Cards

Memory cards can be formatted (i.e., initialized), and files saved on memory cards can be edited. In addition, application programs stored on memory cards can be started up.

Initializing Memory Cards

When a memory card is to be used for the first time after being purchased, it must first be initialized. In addition, if data is lost from a memory card due a drop in the battery voltage, the memory card must be re-initialized after the battery is replaced. If a memory card that has files saved on it is initialized, all of that data will be lost.

The memory cards that can be used with the F200 are the F300-N256 and the F300-N512. If you wish to use a memory card other than one of those, please consult one of the OMRON sales offices listed at the back of this manual.

- 1, 2, 3... 1. Select "C. Memory card."

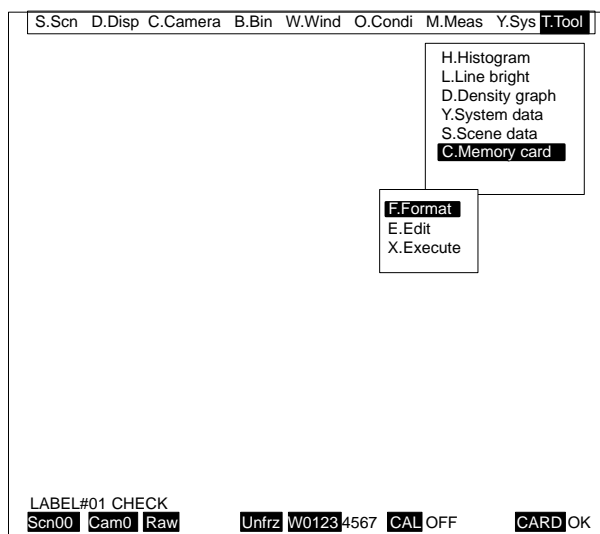

2. Select "F. Format." A confirmation message will be displayed.

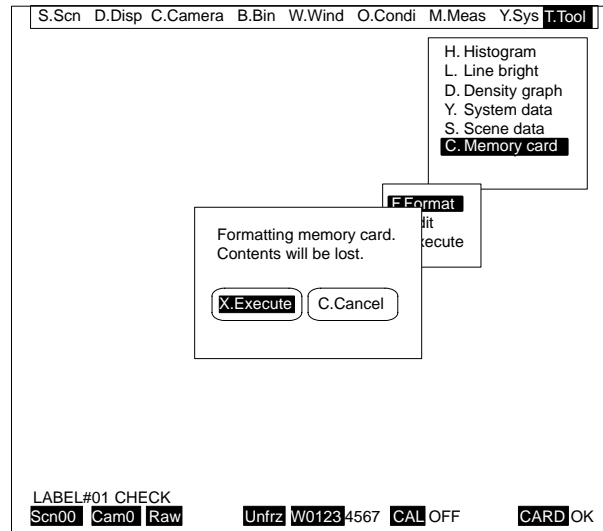

3. Select "X. Execute."

Editing Memory Cards

Files saved on a memory card can be edited one file at a time. There are three ways to edit a file: 1) copying the file, 2) renaming the file, and 3) deleting the file. The procedures for these three methods are outlined below.

Copying the File

- 1, 2, 3... 1. Select "C. Memory card."
2. Select "E. Edit." A list of the files on the memory card will be displayed.

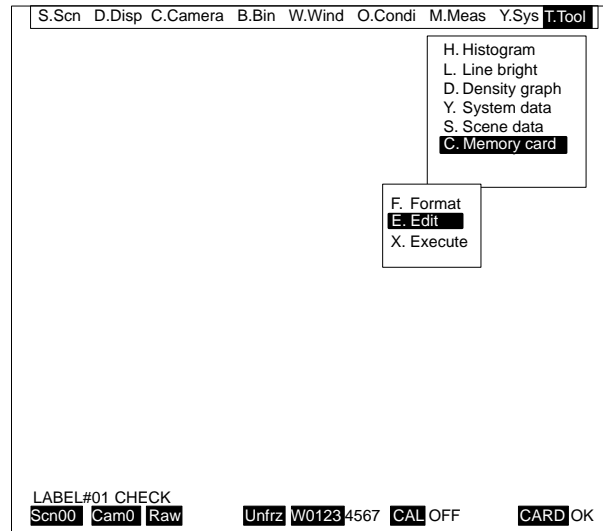

3. Select the name of the file that is to be copied. The “Edit” menu will be displayed.

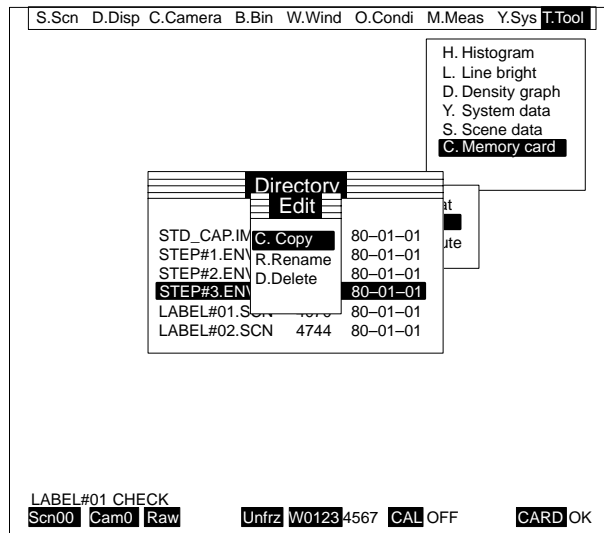

4. Select “C. Copy.”
5. Enter the filename of the copy destination. The filename of the copy source will be displayed as the default, so change that filename. Enter a new filename which includes the extension.

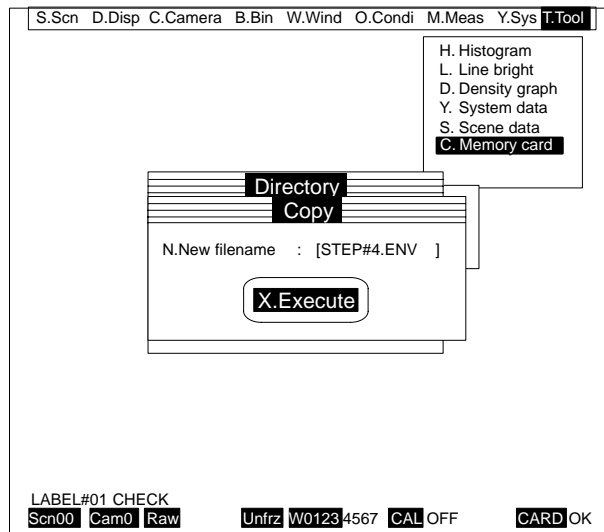

6. Select “X. Execute.” The copy source file will be copied to the memory card under the destination filename that was entered.

Renaming the File

- 1, 2, 3... 1. Select "C. Memory card."
2. Select "E. Edit." A list of the files on the memory card will be displayed.

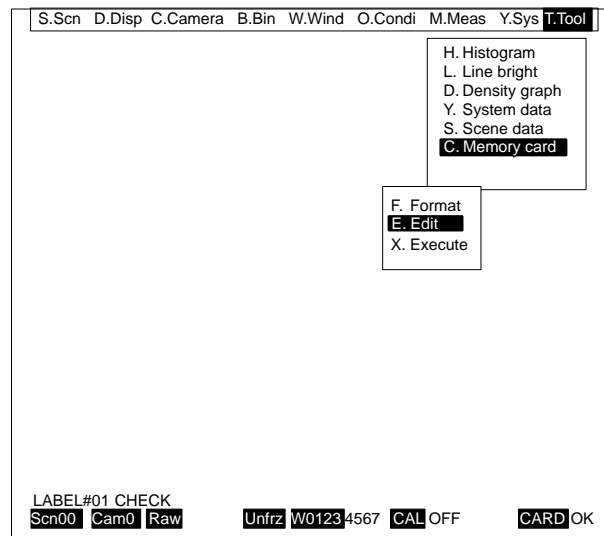

3. Select the name of the file that is to be renamed. The "Edit" menu will be displayed.
4. Select "R. Rename."

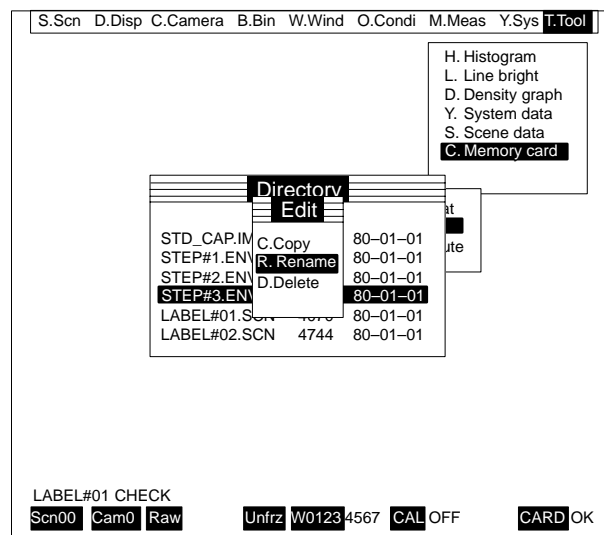

5. Enter the new filename. The existing filename will be displayed as the default, so change that filename. Enter a new filename which includes the extension.

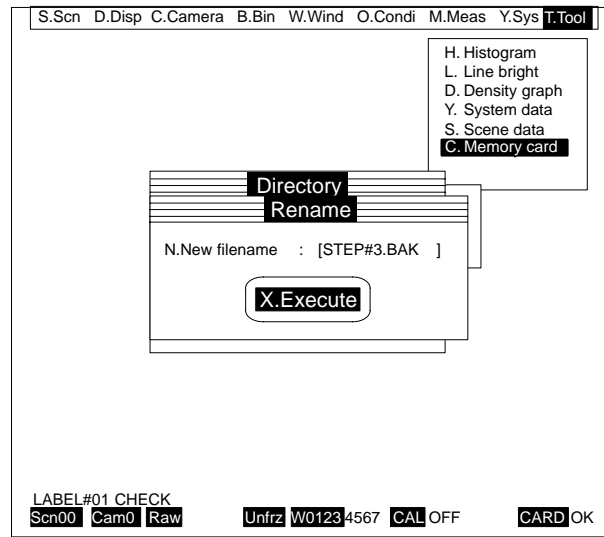

6. Select "X. Execute."

Deleting the File

1, 2, 3...

1. Select "C. Memory card."
2. Select "E. Edit." A list of the files on the memory card will be displayed.

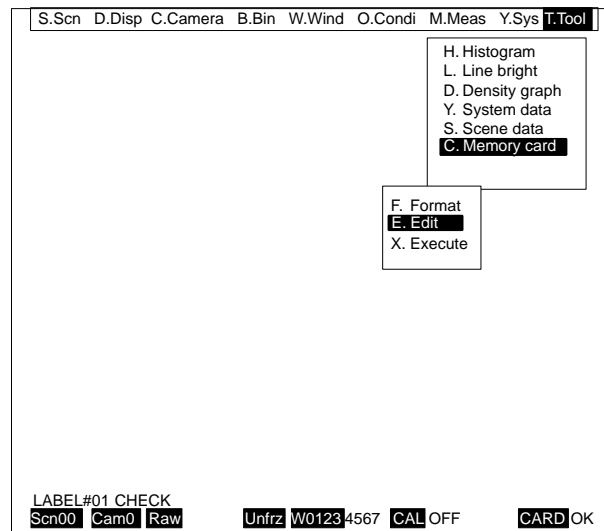

3. Select the name of the file that is to be deleted. The “Edit” menu will be displayed.

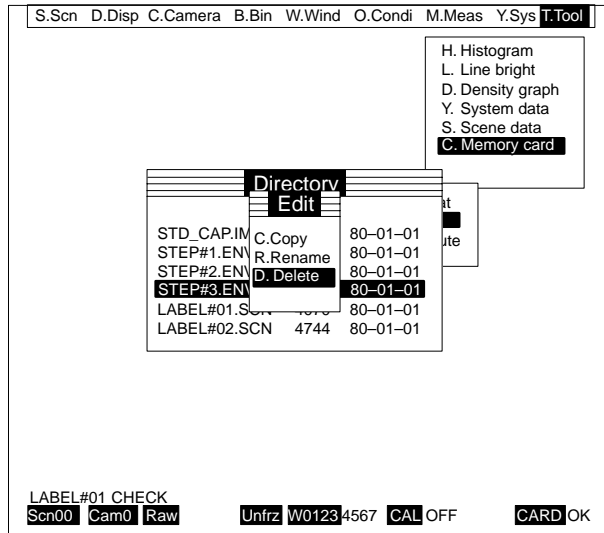

4. Select “D. Delete.” A message will be displayed asking for confirmation.

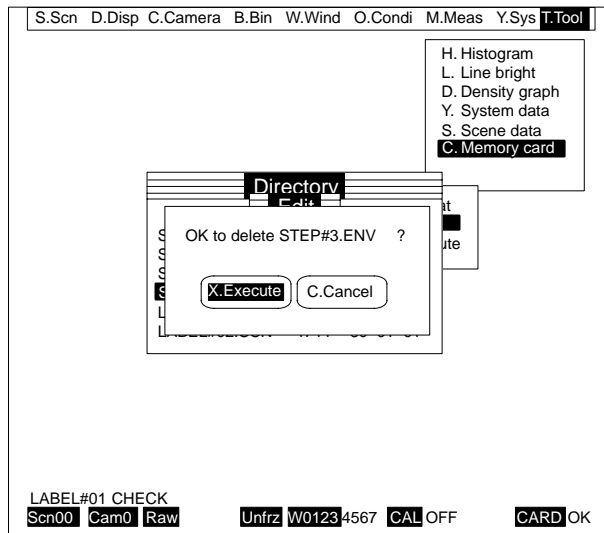

5. Select “X. Execute.”

Starting Up Application Programs

Application programs stored on memory cards can be started up. The extension for an application program is “.VEX.” (At the present time, no application programs are provided.) The procedure for starting up an application program from a memory card is as follows:

- 1, 2, 3...** 1. Select “C. Memory card.”

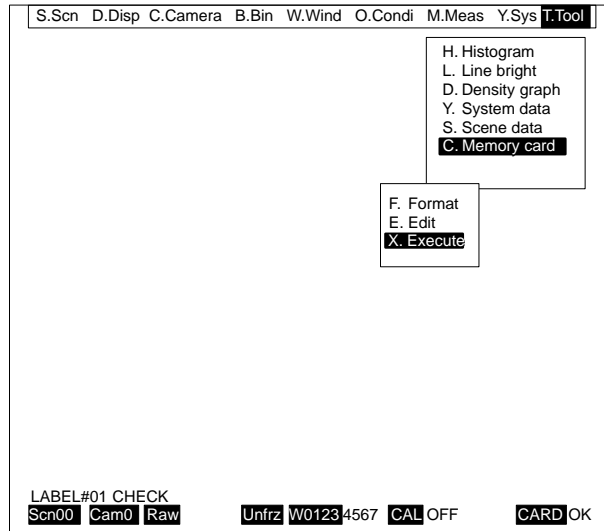

2. Select “X. Execute.” A list of the application programs on the memory card will be displayed.

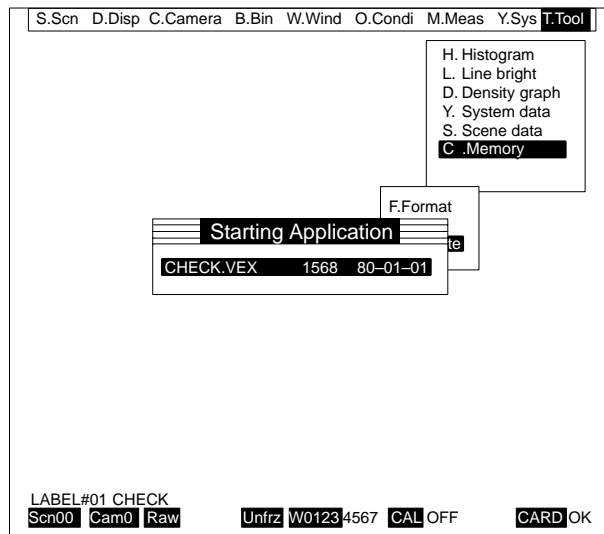

3. Select the application program that is to be started. A message will be displayed asking for confirmation.
4. Select “X. Execute.”

SECTION 5

Inspection, Maintenance and Troubleshooting

This section provides the information essential for maintaining and inspecting the F200. In addition, the F200 displays error messages which identify many types of abnormal system conditions. This section provides troubleshooting charts that can be used to minimize downtime and facilitate quick, smooth error correction.

5-1	Maintenance	192
5-1-1	Replacing the Fuse	192
5-1-2	Battery Replacement	192
5-2	Inspection	193
5-3	Troubleshooting	193
5-3-1	Errors	193
5-3-2	Error Messages	196

5-1 Maintenance

The F200 has two parts that need to be replaced periodically. These are the fuse for the Power Supply Unit and the backup battery for the memory card. The fuse is for short-circuit protection. Follow the procedures below to replace these items.

5-1-1 Replacing the Fuse

Use a fuse with the following specifications: 250 V, 2 A, 5.2 dia. x 20 mm.

- 1, 2, 3...**
1. Turn off the power supply switch at the Power Supply Unit.
 2. Loosen and remove the fuse holder cap with a flat-blade screwdriver. Pull out the cap and remove the fuse located inside.

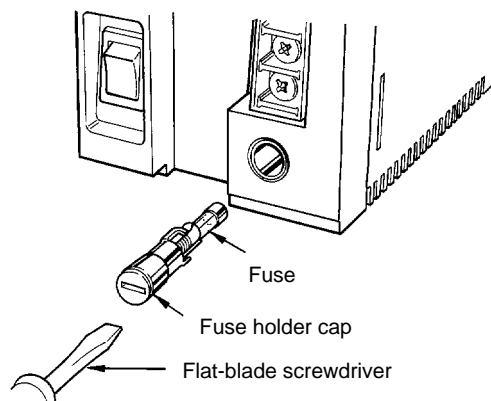

3. Insert a new fuse and replace the cap in its original position.

5-1-2 Battery Replacement

Use a CR2325 battery (a lithium primary battery with a nominal voltage of 3 V). The HMC-BAT01 from OMRON is recommended.

- 1, 2, 3...**
1. Using a pointed implement such as a pin, push down the battery cover from the hole in the right side.

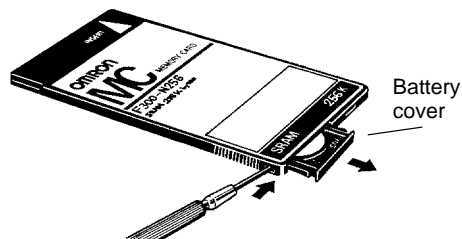

2. Replace the battery, being careful to insert the new battery in the proper direction. To avoid memory loss, be sure to replace the battery within one minute.
3. Put the battery cover back in position.

5-2 Inspection

Inspect the F200 System on a regular basis to maintain it in proper working condition. The following should be checked periodically.

Inspection Points

Inspection point	Details	Required tool
Power supply	The voltage measured at the terminal of the Power Supply Unit must be 85 to 264 VAC.	Circuit tester
Ambient temperature	The ambient temperature inside the cabinet must be 0°C to 50°C.	Thermometer
Ambient humidity	The ambient humidity inside the cabinet must be 35% to 85% RH.	Hygrometer
Installation	Each Unit must be firmly secured.	Phillips screwdriver
	Each cable connector must be correctly inserted and locked.	
	The cameras must be firmly secured.	
	The camera lens mounts must be firmly secured.	
Others	There must be no condensation.	---
	There must be no dust accumulation.	
	The camera lenses must be clean.	

5-3 Troubleshooting

The following troubleshooting charts are divided into two sections. The first section (Errors) provides help in identifying the probable causes of problems that may occur at startup and during operation, and suggests remedies for dealing with those situations. The second section (Error Messages) explains the various error messages that may be displayed.

5-3-1 Errors

Errors at Startup

Symptom	Probable cause and remedy
"CPU HALT" is displayed.	The F200 is not operating properly. Contact the nearest OMRON sales office listed in the back of this manual.
"BUS ERROR" is displayed.	The F200 is not operating properly. Contact the nearest OMRON sales office listed in the back of this manual.

Power Supply Unit

Symptom	Probable cause and remedy
The POWER indicator does not light.	Either there is no power being supplied, or else the voltage is too low. Check to be sure that a power supply of 85 to 264 VDC is being provided. Refer to 2-3 <i>Power and Ground Wiring</i> .
	The fuse is blown. Replace the fuse. Refer to 5-1-1 <i>Replacing the Fuse</i> .
The ERROR indicator does not light even when an error occurs during measurement.	Either "Ignore" (OFF) or "Message" is set as the error output method. Change the setting to "Signal" or "Stop." Refer to 4-8-6 <i>Selecting the Error Output Method</i> .

Video Monitor and Cameras

Symptom	Probable cause and remedy
Nothing appears on the video monitor screen.	The power supply to the video monitor is not turned on. Turn on the power supply.
	The cable to the video monitor is not connected. Connect the cable. Refer to <i>2-2 System Setup</i> .
	The video monitor is defective. Replace the video monitor.
	The monitor cable is defective. Replace the cable.
	The F200-C10E IMP Unit or F300-FM MMI Unit is defective. Replace the Unit.
Images are out of sync.	The camera synchronization method is not correctly set. Set the same synchronization method for all cameras. Refer to <i>4-8-4 Setting Specifications for Connected Cameras</i> .
	An unusable camera is connected. Connect cameras that can be used with the Camera I/F Unit that is mounted. If you wish to use a camera other than those that are recommended, consult with the nearest OMRON sales office listed in the back of this manual. Refer to <i>4-8-4 Setting Specifications for Connected Cameras</i> .
	Camera switches are not correctly set. Set them correctly. Refer to <i>2-2 System Setup</i> .
	The monitor cable is defective. Replace the cable.
Camera images do not appear on the screen.	The cameras are not connected. Connect the cameras. Refer to <i>2-2 System Setup</i> .
	Camera lenses are out of focus. Select the appropriate lens. Refer to <i>Appendix A Specifications</i> .
	A camera is defective. Replace the camera.
	The camera cable is defective. Replace the cable.
	The Camera I/F Unit is defective. Replace the Unit.
Measurement results are not displayed during measurement.	The wrong camera numbers are set. Select camera numbers to match the cameras that are connected. Refer to <i>4-3-1 Selecting Cameras</i> .
	The video monitor is not set as a measurement output device. Set it as an output device. Refer to <i>4-7-2 Outputting Measurement Results</i> .

MMI Units

Symptom	Probable cause and remedy
Key inputs from the console are not being received.	The console is not connected. Connect the console to the console connector. Refer to <i>2-2 System Setup</i> .
LED indicators do not light when a memory card is inserted.	The memory card cover is open. After the memory card is inserted, close the cover.
	The memory card is inserted in the wrong direction. Insert it correctly.
	The memory card is not pushed all the way in. Push it in firmly.

Terminal Block Units and Parallel I/O Units

Symptom	Probable cause and remedy
Signals cannot be input from outside.	Power is not being supplied. Correct the wiring and provide a power supply. Refer to 2-5-5 <i>Connecting Terminal Block Units</i> and 2-5-6 <i>Connecting Parallel I/O Units</i> .
	The Unit is not set as an input device. Set it as an input device. Refer to 4-7-1 <i>Inputting Commands at Measurement Screens</i> .
Even when commands are input from outside, they do not function properly.	The command types and timing are not correct. Set the command specifications, and input the commands correctly.
Signals cannot be output externally.	Power is not being supplied. Correct the wiring and provide a power supply. Refer to 2-5-5 <i>Connecting Terminal Block Units</i> and 2-5-6 <i>Connecting Parallel I/O Units</i> .
	The Unit is not set as a measurement output device. Set it as a measurement output device. Refer to 4-7-2 <i>Outputting Measurement Results</i> .
	If handshaking is set, the external device is not set to receive. Set the status of the external device to receive.
	Power lines are faulty. Check whether the power lines are disconnected or wired incorrectly, and correct the wiring.
When a scene change is executed, the scene does not change to the designated scene.	The signal input timing is incorrect. Turn ON DI5 after scene numbers DI0 to DI3 have been turned ON. Refer to 4-7-1 <i>Inputting Commands at Measurement Screens</i> .
Output data is wrong.	The output specifications are set incorrectly. Correct the specifications. The factory setting is for binary output. Refer to 4-8-3 <i>Setting Parallel Data Output Specifications</i> .

RS-232C I/F Units

Symptom	Probable cause and remedy
Input commands are not being received.	The RS-232C I/F Unit is not set as an input device. Set it as an input device. Refer to 4-7-1 <i>Inputting Commands at Measurement Screens</i> .
	The channel designated for the external device is not connected. Connect the channel. Refer to 4-7-1 <i>Inputting Commands at Measurement Screens</i> .
	The communications specifications do not match those of the external device. Correct the specifications. Refer to 4-8-2 <i>Setting RS-232C Communications Specifications</i> .
	The cables are not properly connected. Correct the wiring. Refer to 2-5-4 <i>Connecting RS-232C I/F Units</i> .
Output data is not being output.	The Unit is not set as a output device. Set it as a measurement output device. Refer to 4-7-2 <i>Outputting Measurement Results</i> .
	The channel designated for the external device is not connected. Connect the channel. Refer to 4-7-2 <i>Outputting Measurement Results</i> .
	The communications specifications do not match those of the external device. Correct the specifications. Refer to 4-8-2 <i>Setting RS-232C Communications Specifications</i> .
	The cables are not properly connected. Correct the wiring. Refer to 2-5-4 <i>Connecting RS-232C I/F Units</i> .

Strobe I/F Units

Symptom	Probable cause and remedy
Strobes do not flash.	The power supply is not turned on for the strobe device. Turn on the power supply.
	The strobe numbers are not correct. Set to ON the numbers of the strobes that are connected. Refer to 4-3-4 <i>Flashing the Strobe</i> .
Measurement results are wrong.	The binary image may change as a result of lighting fluctuations. If this occurs, judgements and position displacement compensation cannot be properly executed. Adjust the binary level and the criteria. Refer to 4-7-5 <i>Changing Images and Criteria at Measurement Screens</i> .

5-3-2 Error Messages

The F200's error messages are listed alphabetically. Refer to this list when an error occurs and the user is not sure what remedy is required.

Error message	Probable cause and remedy
All scenes were saved as group to designated file.	If this file is loaded, the data in all scenes, 0 to 15, will be overwritten and changed. Check carefully before carrying out the operation.
Application run cancelled.	The operation was cancelled because the memory card was not correctly inserted. Insert the memory card correctly and try the operation again.
Camera No. not connected.	The operation could not be carried out because the camera was not connected. Connect the camera.
Cannot compress. Too much image data.	The image is too complex for the image data to be saved.
Cannot copy to same plane number.	The window plane numbers for the copy source and destination are the same. Designate a window plane number that is different from the one currently being displayed.
Cannot copy to same scene number.	The scene numbers for the copy source and destination are the same. Designate a different scene number for the copy destination.
Cannot divide by zero.	Division cannot be carried out by the constant 0. Enter another number.
Cannot draw at specified point position.	If the first, second and third points that are specified are on the same X or Y lines, the graphic cannot be drawn. Likewise for the first and second points specified. If the third point specified is the same as the first point, the graphic cannot be drawn.
Cannot input more than 16 coordinates.	No more than 15 coordinates can be specified for input. Specify 15 or fewer coordinates.
Cannot insert. Already 32 items.	There are now 33 items set for the output expression, and no more than 32 are permitted.
Cannot register graphic. Specified graphic is too complex.	The window cannot be created because the image is too complex. Draw the window by some other method.
Cannot save to memory card. No free space.	There is insufficient space available on the memory card to save the data. Insert a memory card with sufficient space and try the operation again.
Cannot specify more than 31 points.	No more than 30 continuous points can be specified. Draw the graphic using 30 or fewer continuous points.
Cannot take more than 16 samples.	No more than 15 samples can be taken. Take 15 or fewer samples.
Cannot turn all input devices off.	If all input devices are set to "Off," the measurement cannot be executed. Set one of the input devices to "On."
Current settings will be cancelled and previous settings used.	The data that was input will be invalidated. If "C. Cancel" is selected, the data input will continue. If "O. OK" is selected, the input data will be invalidated and the previous settings will be restored.
Draw sampling window.	There is no window drawn for sampling. Draw a window.
File copy cancelled.	The operation was cancelled because the memory card was not correctly inserted. Insert the memory card correctly and try the operation again.
File deletion cancelled.	The operation was cancelled because the memory card was not correctly inserted. Insert the memory card correctly and try the operation again.
File does not exist.	The file does not exist on the memory card. Insert the memory card on which the file is saved.
File format error: data cannot be loaded.	The format is incorrect for the data that is to be loaded. The data may be corrupted or faulty. Make sure that the data is correct, and then try again.
Filename already exists.	The same filename already exists on the memory card. Change the filename and try the operation again.
Filename change cancelled.	The operation was cancelled because the memory card was not correctly inserted. Insert the memory card correctly and try the operation again.

Error message	Probable cause and remedy																
Format not correct.	One of the following items is incorrect in the output expression. <ul style="list-style-type: none"> • The numbers of right and left parentheses in the expression do not match. • There is a measurement item to the right of a right parenthesis. • There is a left parenthesis to the right of a right parenthesis. • There is an operator to the right of an operator. • There is no measurement item to the right of an operator. • There is a measurement item to the right of a measurement item. • There is a left parenthesis to the right of a measurement item. • There is an operator to the right of a left parenthesis. • There is no measurement item to the right of a left parenthesis. 																
Graphics cannot be registered. More than 255 graphics created.	A maximum of 255 window graphics can be drawn for the F200. If that number is exceeded, the window graphics cannot be loaded and drawn.																
Graphics cannot be registered. Window graphic area full.	There is no available space in the area for saving window graphics, so no more window graphics can be loaded and drawn.																
Image data load cancelled.	The load was cancelled because the memory card was not correctly inserted. Insert the memory card correctly and try the operation again.																
Image data save cancelled.	The save was cancelled because the memory card was not correctly inserted. Insert the memory card correctly and try the operation again.																
Incorrect filename. Input again.	Either no filename or an invalid filename has been entered. Enter a valid filename and then try the operation again.																
Incorrect setting combination.	This combination cannot be set. Set one of the combinations shown in the table below. <table border="1" data-bbox="683 968 1098 1350" style="margin-left: auto; margin-right: auto;"> <thead> <tr> <th>Stop bit</th> <th>Data length</th> <th>Parity bit</th> </tr> </thead> <tbody> <tr> <td rowspan="4" style="text-align: center;">1 bit</td> <td rowspan="2" style="text-align: center;">7 bit</td> <td style="text-align: center;">Odd</td> </tr> <tr> <td style="text-align: center;">Even</td> </tr> <tr> <td rowspan="2" style="text-align: center;">8 bit</td> <td style="text-align: center;">None</td> </tr> <tr> <td style="text-align: center;">Odd</td> </tr> <tr> <td rowspan="3" style="text-align: center;">2 bits</td> <td rowspan="2" style="text-align: center;">7 bit</td> <td style="text-align: center;">Even</td> </tr> <tr> <td style="text-align: center;">None</td> </tr> <tr> <td style="text-align: center;">8 bit</td> <td style="text-align: center;">None</td> </tr> </tbody> </table>	Stop bit	Data length	Parity bit	1 bit	7 bit	Odd	Even	8 bit	None	Odd	2 bits	7 bit	Even	None	8 bit	None
Stop bit	Data length	Parity bit															
1 bit	7 bit	Odd															
		Even															
	8 bit	None															
		Odd															
2 bits	7 bit	Even															
		None															
	8 bit	None															
Insufficient number of coordinates. Continue coordinate input?	Only one coordinate was input. Input at least two coordinates.																
Insufficient number of samplings. Continue sampling?	Only one point was sampled. Sample at least two points.																
Insufficient points specified.	When drawing polygons, three or more points must be specified. When drawing curved area, at least four points must be specified. When drawing a continuous line, the first and second points specified must be different.																
Memory backup battery voltage is low.	The IMP Unit's memory backup battery voltage is low. Contact the nearest OMRON sales office listed in the back of this manual.																
Memory card battery voltage is low.	The memory card battery voltage is low. Replace the battery as soon as possible. Refer to 5-1-2 <i>Battery Replacement</i> .																
Memory card format cancelled.	The operation was cancelled because the memory card was not correctly inserted. Insert the memory card correctly and try the operation again.																
Memory card is write protected.	The operation could not be executed because the memory card is write protected. Clear the write protection and try the operation again.																
Memory card not formatted.	The memory card was not formatted (i.e., initialized). Use a memory card that has been formatted.																
Memory card not inserted.	The operation could not be executed because no memory card was inserted. Insert the memory card and try the operation again.																

Error message	Probable cause and remedy
No application file.	The application program is not saved on the memory card. Insert the memory card on which the program is saved. The extension ".VEX" is required for the filename.
No image data.	The image data is not saved on the memory card. Insert the memory card on which the image data is saved. The extension ".IMG" is required for the filename.
No image to sample in window.	The area is "0," so the center of gravity cannot be measured. Display the object to be sampled appears as white pixels within the window.
No scene data.	There is no scene data on the memory card. Insert the memory card on which the scene data is saved. The extension ".SCN" is required for the filename.
No settings data.	There is no data, so the settings cannot be displayed. Input at least two coordinates or sample at least two points.
No system data.	There is no system data on the memory card. Insert the memory card on which the system data is saved. The extension ".ENV" is required for the filename.
No window graphic exists which allows this operation.	A window graphic that cannot be edited is specified. Specify another window graphic. Object generation graphics cannot be rotated or sized. Arcs cannot be rotated.
No window graphics.	Window graphics cannot be edited because they do not exist. Draw the window graphics.
Operation not possible for some of the window graphics. Ignoring uneditable graphics.	There are some window graphics which cannot be edited. Check them before carrying out the operation. Arcs and object generation graphics cannot be rotated, and object generation graphics cannot be sized.
Operation not possible for this window graphic.	A window graphic that cannot be edited is specified. Specify another window graphic. Object generation graphics cannot be rotated or sized. Arcs cannot be rotated.
Output device not connected (I/O Unit).	There is no Terminal Block Unit or Parallel I/O Unit mounted. Turn off the power supply to the F200 and mount an I/O Unit.
Output device not connected (memory card).	The memory card is not correctly inserted. Insert it correctly. If outputting data to the memory card, clear the write protection.
Output device not connected (RS-232C).	There is no RS-232C I/F Unit mounted. Turn off the power supply to the F200 and mount an RS-232C I/F Unit.
Output expression not set.	Measurement cannot be executed because no output expression is set. Set the output expression.
Position compensation window not designated. Designate a window.	There is no window designated for position compensation. Set a window number under the "W. Compensation window" menu.
RS-232C Unit not connected.	No RS-232C I/F Unit is mounted. Turn off the power supply to the F200, and mount an RS-232C I/F Unit. If not using an RS-232C I/F Unit, set the output device to "Off."
Same position cannot be specified.	The graphic cannot be drawn if the same point is specified. Specify a different point.
Scene data load cancelled.	The load was cancelled because the memory card was not correctly inserted. Insert the memory card correctly and try the operation again. A load via RS-232C was cancelled by pressing the Escape Key during the load operation.
Scene data load cancelled. Communications error.	The transmission was aborted as the result of a communications error. Check the following points, and then try the transmission again. <ul style="list-style-type: none"> • A time-out error occurred. • The communications specifications do not match. • The communications path is interrupted. • A cable is disconnected.
Scene data save cancelled.	The save was cancelled because the memory card was not correctly inserted. Insert the memory card correctly and try the operation again. A save via RS-232C was cancelled by pressing the Escape Key during the save operation.

Error message	Probable cause and remedy
Scene data save cancelled. Communications error.	The transmission was aborted as the result of a communications error. Check the following points, and then try the transmission again. <ul style="list-style-type: none"> • A time-out error occurred. • The communications specifications do not match. • The communications path is interrupted. • A cable is disconnected.
Set output period to value greater than delay plus output time.	The numeric settings are incorrect. The output period must be greater than the sum of the delay plus the output time.
Strobe Unit not connected.	Strobes cannot flash because there is no Strobe I/F Unit connected. Turn off the power supply to the F200 and connect a Strobe I/F Unit.
System data load cancelled.	The load was cancelled because the memory card was not correctly inserted. Insert the memory card correctly and try the operation again. A load via RS-232C was cancelled by pressing the Escape Key during the load operation.
System data load cancelled. Communications error.	The transmission was aborted as the result of a communications error. Check the following points, and then try the transmission again. <ul style="list-style-type: none"> • A time-out error occurred. • The communications specifications do not match. • The communications path is interrupted. • A cable is disconnected.
System data save cancelled.	The save was cancelled because the memory card was not correctly inserted. Insert the memory card correctly and try the operation again. A save via RS-232C was cancelled by pressing the Escape Key during the save operation.
System data save cancelled. Communications error.	The transmission was aborted as the result of a communications error. Check the following points, and then try the transmission again. <ul style="list-style-type: none"> • A time-out error occurred. • The communications specifications do not match. • The communications path is interrupted. • A cable is disconnected.
Window No. graphics not drawn.	Measurement cannot be executed because there is no window graphic drawn for the window number specified for position displacement compensation or measurement. Draw the window graphic.
Window No. is designated in output expression. Output expression will be cleared if setting is completed.	Windows used for position displacement compensation cannot be used for measurement. If "C. Cancel" is selected, the screen for selecting windows for position displacement compensation will return. If "O. OK" is selected, the output expression will be cleared.

Appendix A Specifications

This appendix provides the specifications for the Units and cameras that can be used in an F200 Visual Inspection System, and it provides specifications and optical charts to be used in selecting the right lenses.

IMP and MMI Unit Specifications

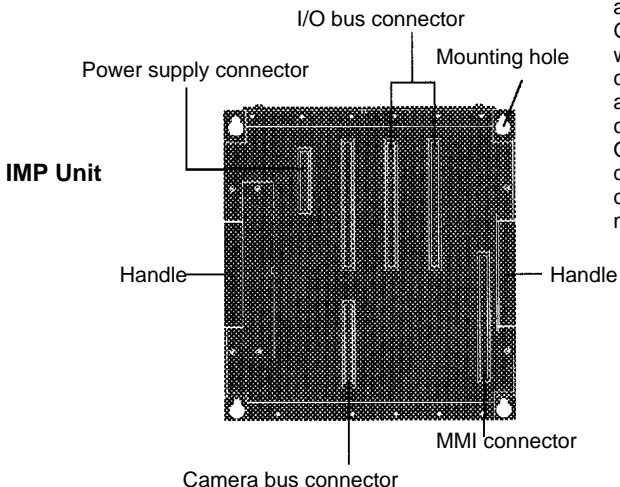
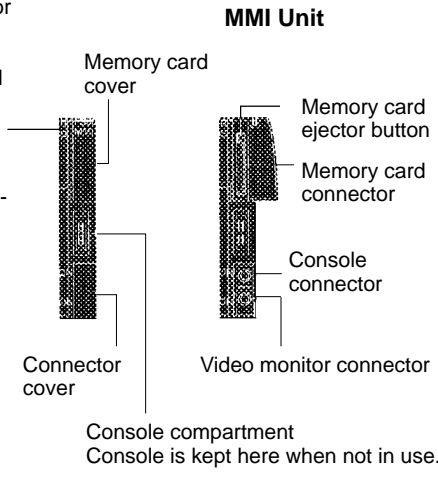
Item	F200-C10E IMP Unit	F300-FM MMI Unit
Description	The F200-C10E Image Processing Unit is the controller for processing measurements and connects other Units in an F200 System. It is an integral part of the basic F200 configuration.	The F300-FM Man Machine Interface Unit connects to the Console and receives key inputs. Connected to the Video Monitor, it displays menus and outputs images. In addition, it saves data to and loads data from memory cards. It is an integral part of the basic F200 configuration.
<p>Outer appearance and nomenclature</p> <div style="display: flex; justify-content: space-around;"> <div style="text-align: center;">  <p>IMP Unit</p> <p>Power supply connector, I/O bus connector, Mounting hole, Handle, Camera bus connector, MMI connector</p> </div> <div style="text-align: center;"> <p>Memory card access indicator Green: Lights when memory card is inserted and cover is closed. Orange: Lights during memory card data transmission.</p>  <p>MMI Unit</p> <p>Memory card cover, Memory card ejector button, Memory card connector, Console connector, Video monitor connector cover, Connector cover, Console compartment (Console is kept here when not in use.)</p> </div> </div>		
Vibration resistance	Vibration frequency: 10 to 150 Hz; single amplitude: 0.15 mm	
Impact resistance	20 G (196 m/s ²)	
Ambient operating temperature	0°C to 50°C	
Ambient operating humidity	35% to 85% RH (no condensation)	
Ambient environment	No corrosive gases	
Storage temperature	-25°C to 65°C	
Ground	Class-3 ground (ground resistance: 100 Ω max.)	
Enclosure rating	IP20 (in-panel)	
Weight	Approx. 1.9 kg	Approx. 660 g

Power Supply Unit Specifications

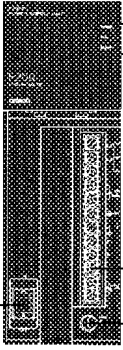
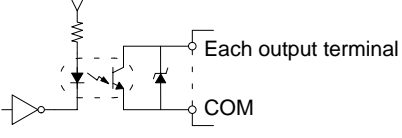
Item	F200-P Power Supply Unit
Description	The F200-P Power Supply Unit takes an AC power supply and provides a DC power supply to each Unit. It is an integral part of the basic F200 configuration.
Outer appearance and nomenclature	 <p>Operation indicators POWER (green): Lit when power is supplied. RUN (orange): Lit during measurement. ERROR (red): Lit when an error occurs.</p> <p>Terminal block</p> <p>Fuse holder cap</p> <p>Power supply switch</p>
Power supply voltage	85 to 264 VAC
Power supply frequency	50 to 60 Hz
Power consumption	150 VA max.
Insulation resistance	20 MΩ min. between all AC external terminals and GR terminal (at 500 VDC)
Dielectric strength	1,500 VAC, 50/60 Hz for 1 minute between all AC external terminals and GR terminal
Leakage current	10 mA max.
Noise resistance	1500 Vp-p; pulse width: 1 μs; rising time: 1 ns (pulse)
Vibration resistance	Vibration frequency: 10 to 150 Hz; single amplitude: 0.15 mm
Impact resistance	20 G (196 m/s ²)
Ambient operating temperature	0°C to 50°C
Ambient operating humidity	35% to 85% RH (no condensation)
Ambient environment	No corrosive gases
Storage temperature	-25°C to 65°C
Ground	Class-3 ground (ground resistance: 100 Ω max.)
Enclosure rating	IP20 (in-panel)
Power supply provided (for Units)	DC + 5 V ± 4%; 3A/DC + 13 V ± 3%; 1A/DC - 12 V ± 5%; 0.3 A
Power supply provided (for service)	DC + 12 V ± 5%; 0.3 A
AC power interrupt detection	10 ms min.
Output type	Photocoupler output
Output voltage	12 to 24 VDC ± 10%
Load current	100 mA
Residual voltage	3 V max.
Leakage current	0.4 mA max.
Internal circuit diagram for output section	 <p>Each output terminal</p> <p>COM</p>
Weight	Approx. 1.2 kg

Camera I/F Unit Specifications



The Camera I/F Unit is an integral part of the F200 System. Any of several types can be used. Select the most suitable Camera I/F Unit based on the cameras that are to be used and the objects that are to be measured.

Item	F300-A20 Normal Camera I/F Unit	F300-A20S Normal Simultaneously Camera I/F Unit
Description	Connects normal cameras and takes the camera images. Can measure stationary objects or moving objects using a strobe.	Connects normal cameras and takes the camera images. Can measure stationary objects or moving objects using a strobe. When two cameras are used, they can measure objects with synchronized timing.
Outer appearance and nomenclature	 <p>Operation indicators CAMERA 0 (orange): Lit when camera is connected to camera connector #0 CAMERA 1 (orange): Lit when camera is connected to camera connector #1</p> <p>Camera connector #0 Camera connector #1</p>	
Vibration resistance	Vibration frequency: 10 to 150 Hz; single amplitude: 0.15 mm	
Impact resistance	20 G (196 m/s ²)	
Ambient operating temperature	0°C to 50°C	
Ambient operating humidity	35% to 85% RH (no condensation)	
Ambient environment	No corrosive gases	
Storage temperature	-25°C to 65°C	
Enclosure rating	IP20 (in-panel)	
Connectable cameras	F300-S, F200-S	F300-S
Number of connectable cameras	Two max.	
Sync signal output frequency	HD, VD both dependent on camera bus synchronous signal.	
Output amplitude	4 V _{p-p} , 1-Ω negative pulse	
Output pulse width	HD, VD both dependent on camera bus synchronous signal.	
Camera power output	+12 V, 0.8 A (for 2 cameras)	
Weight	Approx. 400 g	Approx. 550 g

Item	F300-A20R Shutter Camera I/F Unit	F300-A20RS Shutter Simultaneously Camera I/F Unit
Description	Connects shutter cameras and takes the camera images. Can measure moving objects at high speed.	Connects shutter cameras and takes the camera images. Can measure moving objects at high speed. When two cameras are used, they can measure objects with synchronized timing.
Outer appearance and nomenclature	 <p>Operation indicators CAMERA 0 (orange): Lit when camera is connected to camera connector #0 CAMERA 1 (orange): Lit when camera is connected to camera connector #1</p> <p>Camera connector #0 Camera connector #1</p>	
Vibration resistance	Vibration frequency: 10 to 150 Hz; single amplitude: 0.15 mm	
Impact resistance	20 G (196 m/s ²)	
Ambient operating temperature	0°C to 50°C	
Ambient operating humidity	35% to 85% RH (no condensation)	
Ambient environment	No corrosive gases	
Storage temperature	-25°C to 65°C	
Enclosure rating	IP20 (in-panel)	
Connectable cameras	PJLG-50/55/60-Z (Note: PJLG-50-Z and PJLG-60-Z are not currently available.)	
Number of connectable cameras	Two max.	
Sync signal output frequency	HD: 15.734 kHz; VD: 59.94 Hz	
Output amplitude	4 V _{p-p} , 75-Ω negative pulse	
Output pulse width	HD: 6.27 μs; VD: 9 H	
Camera power output	+12 V, 0.8 A (for 2 cameras); -12 V, 0.2 A (for 2 cameras)	
Weight	Approx. 400 g	Approx. 550 g

Item	F300-A21RS Shutter Simultaneously Camera I/F Unit
Description	Connects PJLG-70-Z Shutter Cameras and takes the camera images. Used for taking images of moving objects. Only one PJLG-70-Z Shutter Camera can be used at a time. (Note the F300-A21RS and PJLG-70-Z are not currently available.)
Outer appearance and nomenclature	 <p>Operation indicators CAMERA 0 (orange): Lit when camera is connected to camera connector #0 CAMERA 1 (orange): Lit when camera is connected to camera connector #1</p> <p>Camera connector #0 Camera connector #1</p>
Vibration resistance	Vibration frequency: 10 to 150 Hz; single amplitude: 0.15 mm
Impact resistance	20 G (196 m/s ²)
Ambient operating temperature	0°C to 50°C
Ambient operating humidity	35% to 85% RH (no condensation)
Ambient environment	No corrosive gases
Storage temperature	-25°C to 65°C
Enclosure rating	IP20 (in-panel)
Connectable cameras	PJLG-70-Z (Note: Not currently available.)
Number of connectable cameras	Two max. (Note: Only one PJLG-70-Z Shutter Camera can be used at a time.)
Sync signal output frequency	HD: 15.734 kHz; VD: 59.94 Hz
Output amplitude	4 Vp-p, 75-Ω negative pulse
Output pulse width	HD: 6.27 μs; VD: 9 H
Camera power output	+12 V, 0.8 A (for 2 cameras); -12 V, 0.2 A (for 2 cameras)
Weight	Approx. 550 g

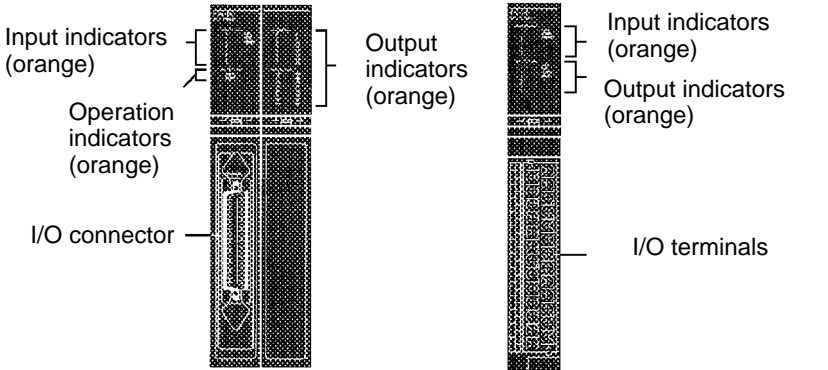
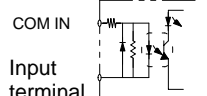
I/O Unit Specifications

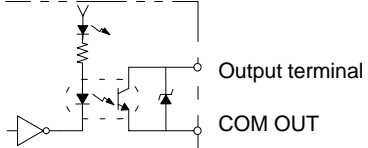
Item	F300-DC Parallel I/O Unit	F300-D Terminal Block Unit
Description	Connects to devices such as Programmable Controllers via parallel I/O. Inputs measurement commands and outputs data (measured values and judgement results).	Connects to devices such as Programmable Controllers via terminal blocks. Inputs measurement commands and outputs data (measured values and judgement results).
Outer appearance and nomenclature		
Vibration resistance	Vibration frequency: 10 to 150 Hz; single amplitude: 0.15 mm	
Impact resistance	20 G (196 m/s ²)	
Ambient operating temperature	0°C to 50°C	
Ambient operating humidity	35% to 85% RH (no condensation)	
Ambient environment	No corrosive gases	
Storage temperature	-25°C to 65°C	
Enclosure rating	IP20 (in-panel)	
Weight	Approx. 800 g	Approx. 400 g
Input Specifications		
Number of input points	Data input: 8; control input: 3	
Input voltage	12 to 24 VDC ±10%	
ON current	3 to 15 mA	
ON voltage	8.8 V	
OFF current	0.1 mA	
OFF voltage	4.5 V min.	
ON delay	Reset input: 10 ms max.; other inputs: 0.5 ms max.	
OFF delay	Reset input: 15 ms max.; other inputs: 0.7 ms max.	
Internal circuit diagrams		
Output Specifications		
Number of output points	Data output: 32; control output: 2	Data output: 8; control output: 2; AND/OR output: 2
Output voltage	12 to 24 VDC ±10%	
Load current	100 mA max.	
ON residual voltage	2 V max.	
OFF leakage current	0.1 mA max.	
Internal circuit diagram		

RS-232C I/F Unit and Strobe I/F Unit Specifications

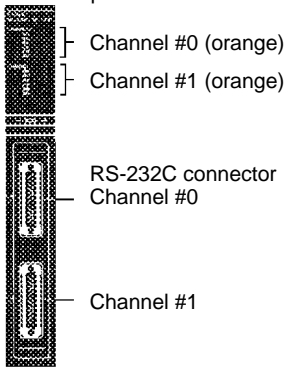
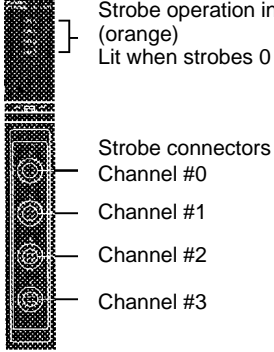
Item	F300-E RS-232C I/F Unit	F300-FS Strobe I/F Unit
Description	Connects to devices such as personal computers via RS-232C interface. Enables data communications and menu operations via RS-232C.	Connects to strobe devices. Used for taking images using strobes.
Outer appearance and nomenclature	 <p>Operation indicators</p> <ul style="list-style-type: none"> Channel #0 (orange) Channel #1 (orange) RS-232C connector Channel #0 Channel #1 	 <p>Strobe operation indicator (orange) Lit when strobes 0 to 3 flash.</p> <p>Strobe connectors</p> <ul style="list-style-type: none"> Channel #0 Channel #1 Channel #2 Channel #3
Vibration resistance	Vibration frequency: 10 to 150 Hz; single amplitude: 0.15 mm	
Impact resistance	20 G (196 m/s ²)	
Ambient operating temperature	0°C to 50°C	
Ambient operating humidity	35% to 85% RH (no condensation)	
Ambient environment	No corrosive gases	
Storage temperature	-25°C to 65°C	
Enclosure rating	IP20 (in-panel)	
Weight	Approx. 400 g	Approx. 400 g
Communications Specifications		
Number of channels	Two	—
Electrical specifications	EIA RS-232C conforming	
Synchronization method	Start stop	
Baud rate	1,200 to 9,600 bps	
Performance Specifications		
Number of connectable strobes	—	Four
Strobe trigger output	—	Photocoupler output; 20 mA max. per unit
Strobe flash error input	—	Photocoupler input
Input ON current	—	3 mA min.
Input OFF current	—	1.5 mA max.

Dummy Unit Specifications

Item	F300-G Dummy Unit
Description	Dummy Units can be inserted into empty slots to protect connectors and reinforce the F200. Dummy Units also serve to give the F200 a neater appearance.
Outer appearance and nomenclature	
Vibration resistance	Vibration frequency: 10 to 150 Hz; single amplitude: 0.15 mm
Impact resistance	20 G (196 m/s ²)
Ambient operating temperature	0°C to 50°C
Ambient operating humidity	35% to 85% RH (no condensation)
Ambient environment	No corrosive gases
Storage temperature	-25°C to 65°C
Weight	Approx. 200 g

Cable Specifications

Item	F309-VM Monitor Cable
Description	Connects the MMI Unit and the Video Monitor
Vibration resistance	Vibration frequency: 10 to 150 Hz; single amplitude: 0.15 mm
Impact resistance	20 G (196 m/s ²)
Ambient operating temperature	0°C to 50°C
Ambient operating humidity	35% to 85% RH (no condensation)
Ambient environment	No corrosive gases
Storage temperature	-25°C to 65°C
Length	2 m, or 5 to 30 m in multiples of 5 m
Minimum bending diameter	150 mm

Item	F309-VS Normal Camera Cable	F309-VSR Shutter Camera Cable
Description	Connects Camera I/F Units and normal cameras.	Connects Camera I/F Units and shutter cameras.
Vibration resistance	Vibration frequency: 10 to 150 Hz; single amplitude: 0.15 mm	
Impact resistance	20 G (196 m/s ²)	
Ambient operating temperature	0°C to 50°C	
Ambient operating humidity	35% to 85% RH (no condensation)	
Ambient environment	No corrosive gases	
Storage temperature	-25°C to 65°C	
Length	5 m, or 10 to 40 m in multiples of 5 m	5 to 15 m in multiples of 5 m. If a PJLG-55-Z Camera is used, then use either 5 m or 10 m cable.
Minimum bending diameter	150 mm	

Item	F309-VR RS-232C Cable	F309-VFS Strobe Cable
Description	Connects RS-232C I/F Units to devices such as personal computers.	Connects Strobe I/F Units to strobe devices.
Vibration resistance	Vibration frequency: 10 to 150 Hz; single amplitude: 0.15 mm	
Impact resistance	20 G (196 m/s ²)	
Ambient operating temperature	0°C to 50°C	
Ambient operating humidity	35% to 85% RH (no condensation)	
Ambient environment	No corrosive gases	
Storage temperature	-25°C to 65°C	
Length	5 m	2 m
Minimum bending diameter	150 mm	

Console Specifications

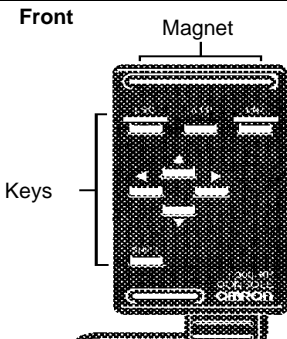
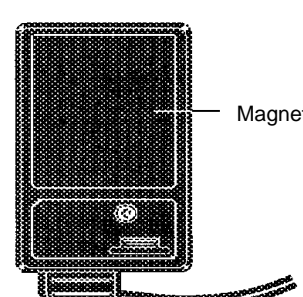
Item	F300-KP Console
Description	The console is used for carrying out menu operations. It is an integral part of an F200 System.
Outer appearance and nomenclature	<div style="display: flex; justify-content: space-around;"> <div style="text-align: center;"> <p>Front</p>  <p>Keys</p> </div> <div style="text-align: center;"> <p>Rear</p>  <p>Magnet</p> </div> </div>
Vibration resistance	Vibration frequency: 10 to 150 Hz; single amplitude: 0.15 mm
Impact resistance	20 G (196 m/s ²)
Ambient operating temperature	0°C to 50°C
Ambient operating humidity	35% to 85% RH (no condensation)
Ambient environment	No corrosive gases
Storage temperature	-25°C to 65°C
Enclosure rating	IP20 (in-panel)
Weight	Approx. 240 g (excluding accessories)

Video Monitor Specifications

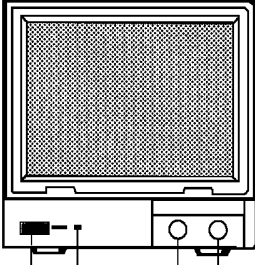
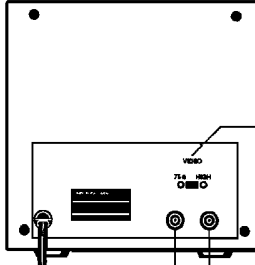
Item	F309-M09 Video Monitor	
Description	The Video Monitor displays menus and camera images, and is used for outputting data such as measured values and judgement results. With the F200, all operations are carried out while looking at the Video Monitor. It is an integral part of an F200 System.	
Outer appearance and nomenclature	<div style="display: flex; justify-content: space-around;"> <div style="text-align: center;"> <p>Front</p>  <p>Power switch Power indicator</p> <p>Brightness control Contrast control</p> </div> <div style="text-align: center;"> <p>Rear</p>  <p>Terminal resistance switch</p> <p>Video input terminal Video output terminal</p> </div> </div>	
Power supply voltage	100 VAC	
Current consumption	Approx. 300 mA	
Vibration resistance	Vibration frequency: 10 to 150 Hz; single amplitude: 0.15 mm	
Impact resistance	20 G (196 m/s ²)	
Ambient operating temperature	0°C to 40°C	
Ambient operating humidity	10% to 90% RH (no condensation)	
Ambient environment	No corrosive gases	
Storage temperature	-25°C to 65°C	
Weight	Approx. 5.8 kg	
Performance Specifications		
Rating	System	Number of scanning lines: 525 Horizontal frequency: 15.75 kHz Field frequency: 60 Hz
	I/O impedance	75W, high impedance (selectable)
	I/O level and polarity	Image: 0.7 V (peak to peak), positive Cycle: 0.3 V (peak to peak), negative
	Screen size	164 x 123 mm (W x H), monochrome (light-holding type)
Performance	Resolution	700 TV min. (at center)

Normal Camera Specifications

Item	F200-S	F300-S
Description	Takes images of stationary objects or moving objects using strobes.	Takes images of stationary objects or moving objects using strobes.
Outer appearance and nomenclature	<p>The diagram shows the F300-S camera from a side and rear perspective. The side view shows the lens assembly on the left, a tripod attachment point at the bottom, and the camera body extending to the right. The rear view shows a control panel with an AGC switch, a GAIN trimmer, and an SHT switch. There are also two circular ports and two screws on the rear panel.</p>	
Power supply	10 to 16 VDC	12 VDC ± 10%
Vibration resistance	Vibration frequency: 10 to 150 Hz; single amplitude: 0.75 mm	Vibration frequency: 10 to 150 Hz; single amplitude: 0.15 mm
Impact resistance	20 G (196 m/s ²)	
Ambient operating temperature	0°C to 50°C	
Ambient operating humidity	35% to 85% RH (no condensation)	
Ambient environment	No corrosive gases	
Storage temperature	-25°C to 65°C	
Picture element	1/3" Interline CCD	2/3" Interline CCD
Effective pixels	512 (H) x 492 (V)	768 (H) x 493 (V)
Synchronization	Internal sync	Internal/external sync (Automatic switching)
Object illumination	Standard: 330 lux; F8 Minimum: 3 lux; F1.4	Standard: 200 lux; F4 (3,200°K) AGC: ON; $\gamma = 1.0$ Minimum: 0.5 lux; F1.4 GAIN: MAX; $\gamma = 0.45$
Resolution	Horizontal: 350 lines (center)	Horizontal: 570 lines; Vertical: 350 lines
S/N ratio	50 dB _{p-p} /rms	
AGC	OFF	Switchable ON/OFF with selector on panel. OFF on delivery.
Electronic shutter	—	Switchable ON/OFF with selector on panel. OFF on delivery.
Lens mounting	C mount	
Weight	Approx. 150 g	Approx. 200 g

Memory Card Specifications

Item	F300-N256	F300-N512
Description	System data, scene data, and output data (measured values and judgement results) can be saved on memory cards.	
Outer appearance and nomenclature		
Vibration resistance	Vibration frequency: 10 to 150 Hz; single amplitude: 0.15 mm	
Impact resistance	20 G (196 m/s ²)	
Ambient operating temperature	0°C to 50°C	
Ambient operating humidity	35% to 85% RH (no condensation)	
Ambient environment	No corrosive gases	
Storage temperature	-25°C to 65°C	
Capacity	256K bytes	512K bytes
Effective life of battery when stored (at an ambient temperature of 20°C)	5 years	4 years

Lens Specifications

This section provides specifications for the various types of lens that can be used with an F200 System, and explains how to perform the calculations for optical systems.

Imaging Formula

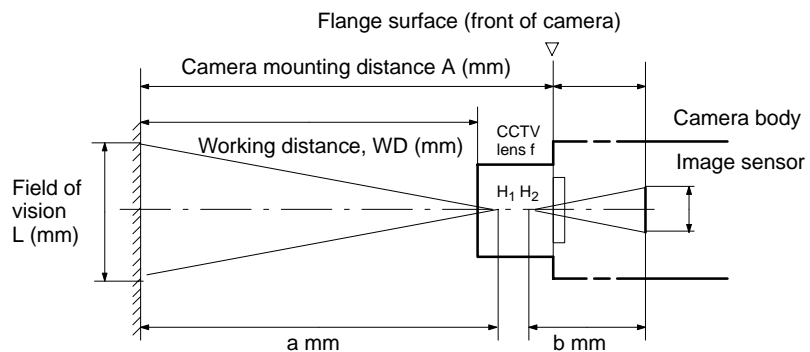

If “f” in the illustration above is made to represent the actual focal distance, then the imaging formula will be as follows:

$$\frac{1}{a} + \frac{1}{b} = \frac{1}{f}$$

$$\frac{b}{a} + \frac{l}{L} = \frac{\text{Effective screen of image sensor}}{\text{Field of vision}}$$

H₁ and H₂ in the illustration are called “principal points,” and they are the standards for distance in the imaging formula. The principal points are fixed according to the lens, so the image will fade out of focus if the object is in at a distance other than “a.” For that reason, the lens is ordinarily provided with an adjustment mechanism which allows the focus to be maintained by changing the value of “b.”

Extension Tubes

$$\frac{1}{a} + \frac{1}{b} = \frac{1}{f}$$

The lens is normally provided with a range-finder mechanism so that the imaging formula can be satisfied by adjusting the value of “b” by means of moving the lens. For taking images of objects at infinite distance, $b = f$. When it is necessary to move the camera closer to the object than can be achieved by adjusting the value of “b” (that is, closer than $b = f + \Delta b$ when the range finder is fully played out), however, then an extension tube can be used for that purpose. In other words, extension tubes can be used to move the camera closer to the object, outside the focal adjustment range of the lens. The extension tube thickness can be calculated as follows:

First find the required value of “b” by optical calculation.

- If the required value of “b” satisfies the following formula, then an extension tube is not required: $(f + \Delta b) > b > f$
- If the required value of “b” is greater than $(f + \Delta b)$, then an extension tube is required. The extension tube of the minimum required thickness, “t,” can be found by “ $b - (f + \Delta b)$.”

The required extension tube thickness can thus be found by means of the following formula: $[b - (f + \Delta b)] < t < (b - f)$

Note The screw section of an extension tube is 3.5 mm. Therefore, an extension of only 1.5 mm to 5 mm cannot be achieved. If the extension is to exceed 30 mm, reinforcement may be required depending on the vibration conditions.

Model	Max. external diameter	Thickness	Comment
3Z4S-LE EX-C6	31-dia.	0.5 mm, 1 mm, 5 mm, 10 mm, 20 mm, 40 mm	Use a combination of tubes to give the required thickness.

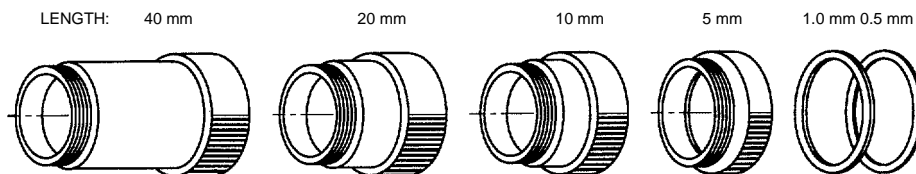

Magnification Lens

The imaging formula is set up such that images are magnified at the image sensor by increasing distance “b.” The magnification lens does not have a helicoid, so the magnification WD is fixed. To focus, adjust the camera position. There is low illumination, so use a strong light source such as fiber optic.

Optical Charts

An optical chart shows the relationship between the lens (the diagonal lines on the graph), camera distance (A), extension tube thickness (t), and field of vision (L). Logarithms are written for the field of vision along the horizontal axis and the camera distance along the vertical axis. Use optical charts as references for selecting the lens appropriate for a particular measured object. Optical charts vary according to the camera’s CCD size, so be sure to use an optical chart that conforms to the camera that is being used.

F300-S Cameras

A (mm)

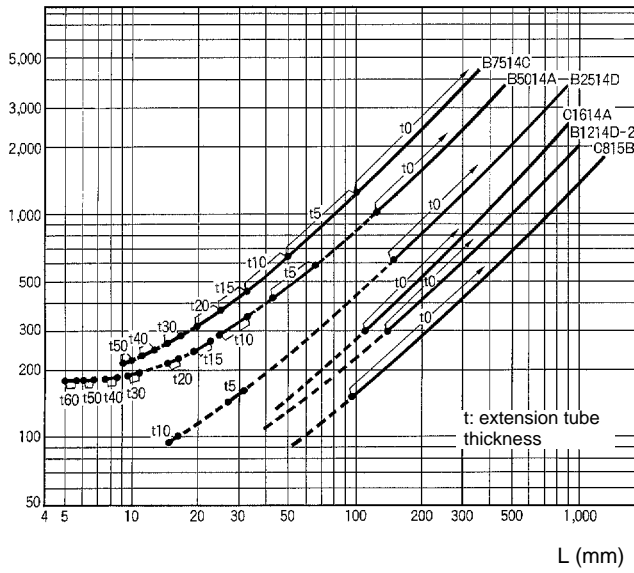

A (mm)

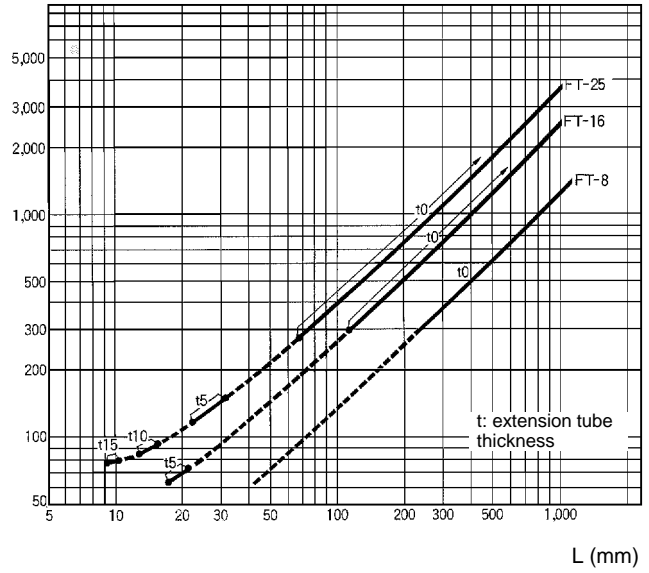

PJLG-55-Z Cameras

A (mm)

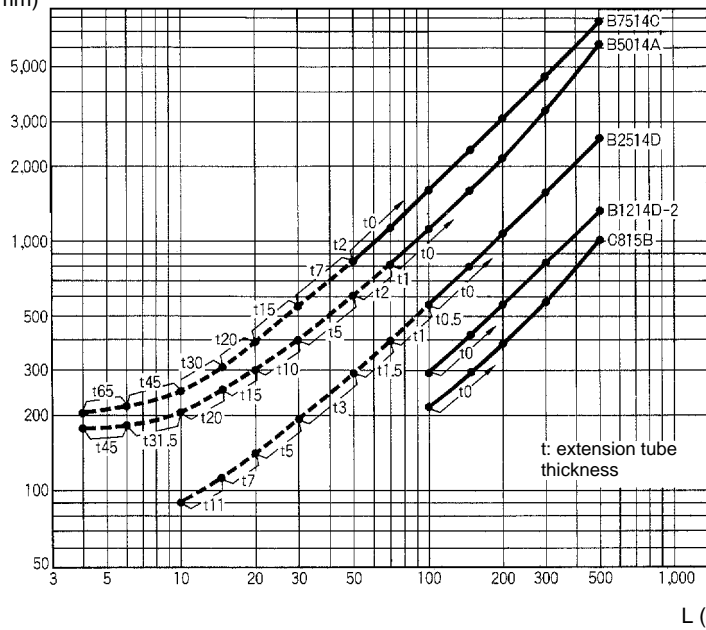

F200-S Cameras

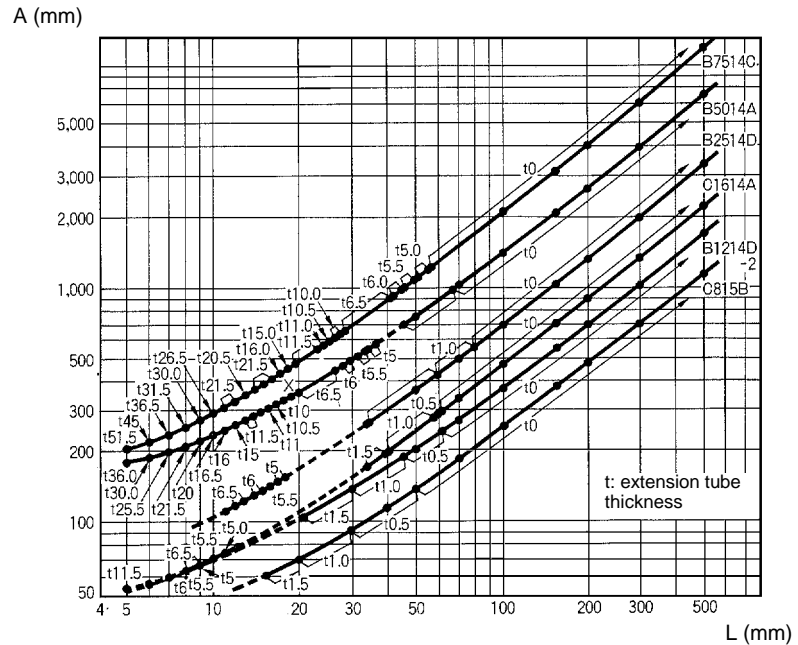

Lens Types and Dimensions

The cameras used with the F200 System can use a 4.8 to 75-mm CCTV lens or a 2x to 6x magnification lens. A wide-angle or narrow field of vision can be set depending on which lens is selected. Select a lens and mounting distance to conform to the desired field of vision. Lenses other than those shown here can also be used with a C-mount lens. In that case, determine the field of vision and mounting distance by trial and error.

CCTV Lens

Model	Focal distance	Illumination	Max. external diameter	Total length	Filter size
3Z4S-LE C418AX	4.8 mm	F1.8	42 mm dia.	32 mm	M40.5 x P0.5
3Z4S-LE B618CX	6.5 mm	F1.8	48 mm dia.	42 mm	
3Z4S-LE C815B	8.5 mm	F1.5	42 mm dia.	40 mm	
3Z4S-LE B1214D-2	12.5 mm	F1.4	42 mm dia.	50 mm	
3Z4S-LE C1614A	16.0 mm	F1.4	30 mm dia.	33 mm	
3Z4S-LE B2514D	25.0 mm	F1.4	30 mm dia.	37.3 mm	M46 x P0.75
3Z4S-LE B5014A	50.0 mm	F1.4	48 mm dia.	48 mm	
3Z4S-LE B7514C	75.0 mm	F1.4	62 mm dia.	79 mm	

Magnification Lens

Model	Magnification	Illumination	End diameter
3Z4S-LE ELE-008-2.5	2.5	F12	14 mm dia.
3Z4S-LE ELE-008-4	4.0	F17	
3Z4S-LE ELE-008-6	6.0	F24	
3Z4S-LE ELE-009-2	2.0	F12	22 mm dia.
3Z4S-LE ELE-009-4	4.0	F20	
3Z4S-LE ELE-009-6	6.0	F27	

Zoom Lens

Model	Operation	Focal distance	Filter size
3Z4S-LE C6Z1218	Manual	12.5 to 75 mm	M49 x P0.75

CCTV Lens, Field of Vision and Mounting Distance

In this table, A = camera distance, WD = working distance, and t = extension tube thickness. The figures are approximate, when the 2/3-inch CCD dimension l = 6.546 mm.

(Unit: mm)

Field of vision		5	7	10	15	20	30	50	70	100	150	200	300	500	
CCTV lens	3Z4S-LE C815B	A								153.2	218.2	283.3	413.7	674.4	
		WD								112.6	177.8	243.0	373.5	634.3	
		t								---	---	---	---	---	
	3Z4S-LE B1214D-2	A										320.1	416.6	609.9	996.5
		WD										269.5	366.2	559.6	946.4
		t										---	---	---	---
	3Z4S-LE B2514D	A				101.0		152.8		302.2	415.9	606.1	796.5	1,177.6	1,940.1
		WD				52.8		110.0		262.6	377.0	567.7	758.4	1,139.8	1,902.4
		t				10		5		---	---	---	---	---	---
	3Z4S-LE B5014A	A	183.3	179.9	188.7	216.0	248.7	319.5	467.7			1,226.2	1,607.1	2,369.3	3,894.6
		WD	69.9	85.2	108.0	146.2	184.3	260.6	413.2			1,176.0	1,557.4	2,320.2	3,845.9
		t	65	45	30	20	15	10	5			---	---	---	---
	3Z4S-LE B7514C	A			217.7	258.6	307.7	414.1	636.7	863.0	1,204.6	1,775.8	2,347.8	3,492.6	5,783.2
		WD			89.6	146.9	204.2	318.7	547.9	777.0	1,120.7	1,693.5	2,266.3	3,411.9	5,703.2
		t			45	30	20	15	5	5	---	---	---	---	---

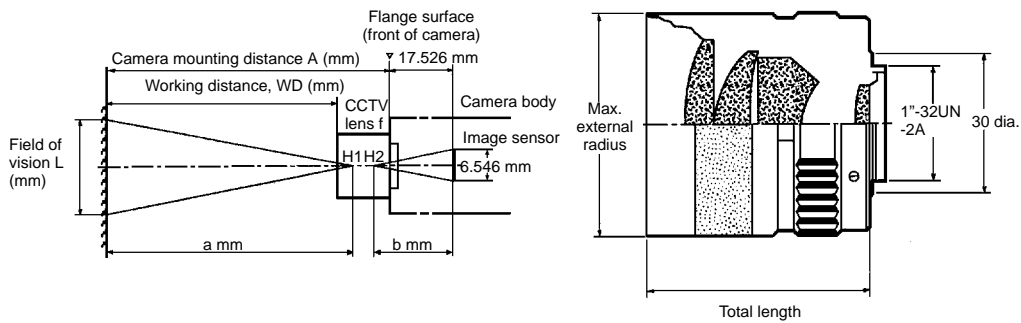

The above figures are approximate standards. Allow for some fine adjustment at the time of installation.

Magnification Lens, Field of Vision and Working Distance

Model	Magnification	Field of vision	Working distance (W_D)	Total length L	L'	End diameter
3Z4S-LE ELE-008-2.5	2.5	2.6	45.8	48.6	54	14 mm dia.
3Z4S-LE ELE-008-4	4.0	1.6	43.9	67.0	70	
3Z4S-LE ELE-008-6	6.0	1.1	42.9	91.5	97	
3Z4S-LE ELE-009-2	2.0	3.3	73.7	67.4	72	22 mm dia.
3Z4S-LE ELE-009-4	4.0	1.6	69.2	103.3	108	
3Z4S-LE ELE-009-6	6.0	1.1	67.8	139.3	144	

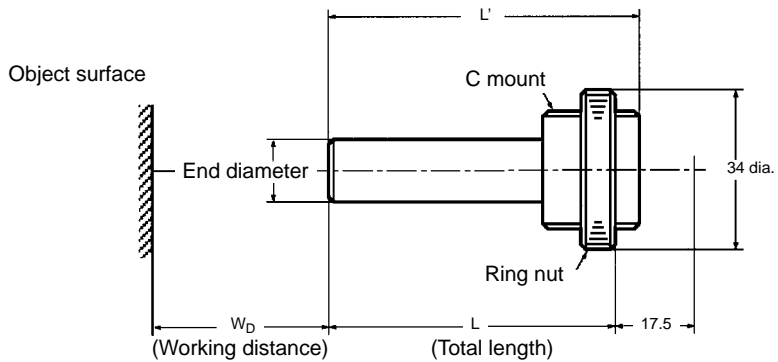

Zoom Lens, Working Distance

Model	Operation	Focal distance	W_D	Face angle (2/3-in. picture elements)	Filter size
3Z4S-LE C6Z1218	Manual	12.5 to 75 mm	1.0 m to ∞	Horizontal: 39°43' to 6°40' Vertical: 30°02' to 5°01'	M49 x P0.75

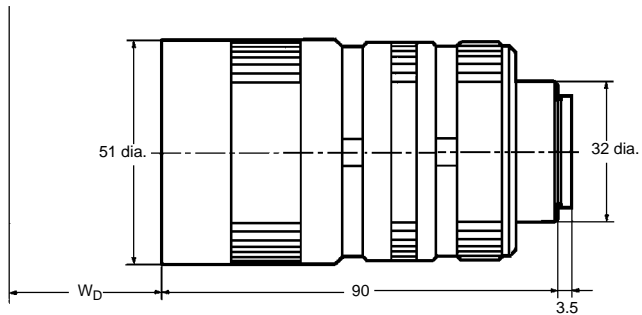

Teleconverter

Insert the Teleconverter between the lens and the camera to double the focal length.

Model	Max external diameter	Thickness
3Z4S-LE 2-EX	30.5 mm dia.	11.5 mm

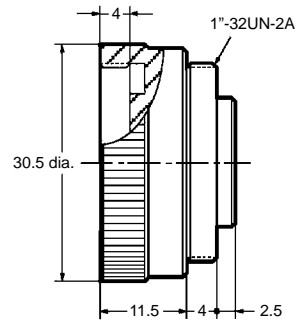

Note The focal distance and brightness change in proportion to the teleconverter magnification. Note that the markings on the lens focus ring and aperture ring are not accurate when the teleconverter is used. These settings must be adjusted to compensate for the teleconverter magnification factor.

Appendix B

Measurement Time Charts

This appendix provides time charts related to measurement operations. The measurement processing time varies depending on the type and number of camera used. During processing, the BUSY signal turns ON and commands cannot be input. The time charts are classified here according to the method of inputting commands.

1) Continuous Measurement

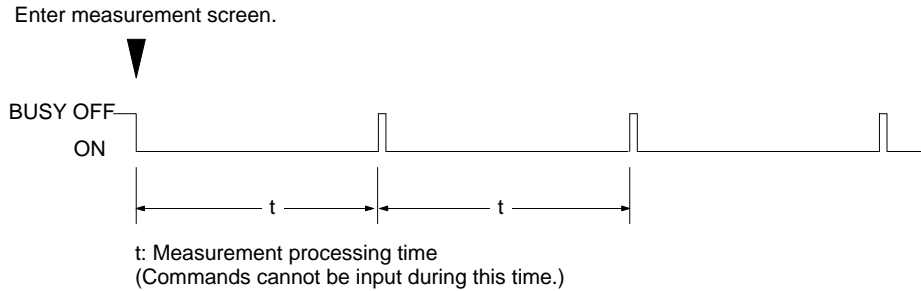

When One Camera is Used

Position displacement compensation	Measurement	t
None	Normal	33.3 ms
None	Fast	16.7 ms
Normal	Normal	66.7 ms
Fast	Normal	50.0 ms
Fast	Fast	33.3 ms

When Two Cameras are Used

Camera 0		Camera 1		t
Position displacement compensation	Measurement	Position displacement compensation	Measurement	
None	Normal	None	Normal	66.7 ms
None	Normal	Normal	Normal	100.0 ms
None	Normal	Fast	Normal	83.3 ms
None	Fast	None	Fast	33.3 ms
None	Fast	Fast	Fast	50.0 ms
Normal	Normal	Normal	Normal	133.3 ms
Fast	Normal	Fast	Normal	100.0 ms
Fast	Fast	Fast	Fast	66.7 ms

Note If measurements are executed using two F200-S Cameras (internally synchronized), then the camera changing time (133.3 ms) will be added to t. For details, refer to 4-6-6 *Checking Data Set by O. Conditions*.

2) Console, I/O Unit, and RS-232C Input

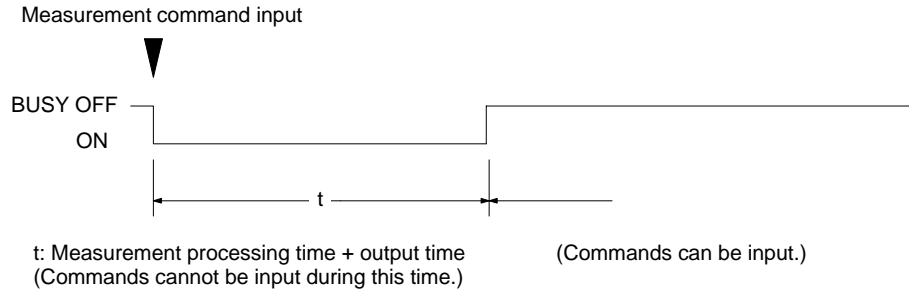

When One Camera is Used

Position displacement compensation	Measurement	t
None	Normal	33.3 to 50.0 ms + output time
None	Fast	16.7 to 33.3 ms + output time
Normal	Normal	66.7 to 83.3 ms + output time
Fast	Normal	50.0 to 66.7 ms + output time
Fast	Fast	33.3 to 50.0 ms + output time

When Two Cameras are Used

Camera 0		Camera 1		t
Position displacement compensation	Measurement	Position displacement compensation	Measurement	
None	Normal	None	Normal	66.7 to 83.3 ms + output time
None	Normal	Normal	Normal	100.0 to 116.7 ms + output time
None	Normal	Fast	Normal	83.3 to 100.0 ms + output time
None	Fast	None	Fast	33.3 to 50.0 ms + output time
None	Fast	Fast	Fast	50.0 to 66.7 ms + output time
Normal	Normal	Normal	Normal	133.3 to 150.0 ms + output time
Fast	Normal	Fast	Normal	100.0 to 116.7 ms + output time
Fast	Fast	Fast	Fast	66.7 to 83.3 ms + output time

- Note**
- 1.The output time varies depending on factors such as the output expression settings and the output device used.
 - 2.If measurements are executed using two F200-S Cameras (internally synchronized), then the camera changing time (133.3 ms) will be added to t.
 - 3.The processing time displayed at the menu is the minimum processing time . For details, refer to 4-6-6 *Checking Data Set by O. Conditions*.

3) STEP Signals

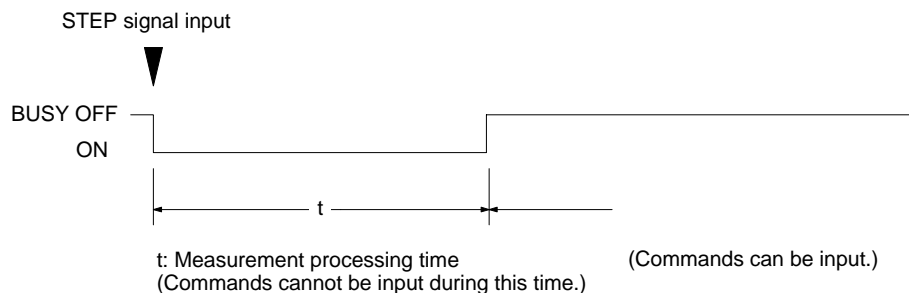

When One Camera is Used

Position displacement compensation	Measurement	t
None	Normal	Approx. 16.7 to 33.3 ms
None	Fast	Approx. 0.0 to 16.7 ms
Normal	Normal	Approx. 50.0 to 66.7 ms
Fast	Normal	Approx. 33.3 to 50.0 ms
Fast	Fast	Approx. 16.7 to 33.3 ms

When Two Cameras are Used

Camera 0		Camera 1		t
Position displacement compensation	Measurement	Position displacement compensation	Measurement	
None	Normal	None	Normal	Approx. 50.0 to 66.7 ms
None	Normal	Normal	Normal	Approx. 83.3 to 100.0 ms
None	Normal	Fast	Normal	Approx. 66.7 to 83.3 ms
None	Fast	None	Fast	Approx. 16.7 to 33.3 ms
None	Fast	Fast	Fast	Approx. 33.3 to 50.0 ms
Normal	Normal	Normal	Normal	Approx. 116.7 to 133.3 ms
Fast	Normal	Fast	Normal	Approx. 83.3 to 100.0 ms
Fast	Fast	Fast	Fast	Approx. 50.0 to 66.7 ms

- Note**
1. If measurements are executed using cameras other than the F200-S Cameras, 16.7 ms is to be added to t.
 2. If measurements are executed using two F200-S Cameras (internally synchronized), then the camera changing time (133.3 ms) will be added to t.
 3. The processing time displayed at the menu is the minimum processing time. For details, refer to 4-6-6 *Checking Data Set by O. Conditions*.

Appendix C

RS-232C Data Transmission Program Example

This appendix provides two sample programs. The first uses the command response function, and the second loads and saves scene data and system data.

1) Using the Command Response Function

This is a sample program for receiving command responses at a personal computer when commands are input to the F200 via RS-232C. With this program, "scene change" and "measure" commands can be reliably executed at the measurement screen. The communications specifications for the F200 and the personal computer are listed in the table below.

Baud rate	9,600 bps
Data length	8 bits
Parity	None
Stop bits	1
Delimiter	CR + LF

```

'*****
'
'          (c)Copyright OMRON Co.1994
'          All Rights Reserved
'          Sample Program
'Sample Program Using the Command Response Function
'*****

CLS
ON ERROR GOTO ERRORMES
ON KEY(1) GOSUB ENDPROG
KEY(1) ON
OPEN "COM1:9600,N,8,1,ASC" FOR RANDOM AS #1 'Sets the communications specifications.

START:

SCN$ = "0"
GOSUB SCNCHNG
GOSUB MEASURE
SCN$ = "1"
GOSUB SCNCHNG
GOSUB MEASURE
GOTO START

SCNCHNG:          ' Changes the scene.

PRINT #1, "S" + SCN$          ' Inputs the command to change the scene.
IF INPUT$(1, #1) <> CHR$(6) THEN ERROR 255 ' An error is generated for a code other than ACK.
PRINT "SCENE" + SCN$
IF INPUT$(1, #1) <> CHR$(4) THEN ERROR 255 ' An error is generated for a code other than EOT.
RETURN

MEASURE:          ' Inputs the measure command.

PRINT #1, "M"
IF INPUT$(1, #1) <> CHR$(6) THEN ERROR 255 ' An error is generated for a code other than ACK.
DO

```

```

D$=INPUT$(1, #1)
IF D$ <> CHR$(4) THEN PRINT D$;           ' Results are output until the EOT code is returned.
LOOP WHILE D$ <> CHR$(4)
PRINT
RETURN

```

ERRORMES: ' If an error is generated.

```

IF ERR = 255 THEN
  PRINT
  PRINT "ERROR"
END IF
RESUME ENDPROG

```

ENDPROG: ' The program is ended.

```

ON ERROR GOTO 0
CLOSE #1
END

```

2) Saving and Loading Data This is a sample program for saving and loading system data via RS-232C. Carry out the operations according to the messages displayed at the personal computer. The communications specifications for the F200 and the personal computer are listed in the table below.

Baud rate	9,600 bps
Data length	8 bits
Parity	None
Stop bits	1
Delimiter	CR + LF

```

' *****
'                                     (c)Copyright OMRON Co.1994
'                                     All Rights Reserved
'                                     Sample Program
' Save/Load Sample Program for System Data/Scene Data
' *****

```

```

CLS
CLEAR

```

```

N$(1) = "Saving system data"           ' Select System/Scene Data, Save/Load .
N$(2) = "Loading system data"
N$(3) = "Saving scene data"
N$(4) = "Loading scene data"
FOR i = 1 TO 4
  PRINT N$(i) + "---->"; i
NEXT i

```

```

WHILE FLG < 1 OR FLG > 4
  LOCATE 6, 1
  PRINT SPACE$(80);
  LOCATE 6, 1
  INPUT "Input number 1 to 4 > ", FLG
WEND

```

```

LOCATE 8, 1
INPUT "Input file name > ", F$(1)     ' Open the file.

```

```

F$(2) = "COM1:9600,N,8,1"
SELECT CASE FLG
  CASE 1, 3
    OPEN F$(2) FOR INPUT AS #1
    OPEN F$(1) FOR OUTPUT AS #2
  CASE 2, 4
    OPEN F$(1) FOR INPUT AS #1
    OPEN F$(2) FOR OUTPUT AS #2
END SELECT

LOCATE 10, 1
PRINT "Execute " + N$(FLG) ' Prompt Execution of the Save or Load at the F200 .
IF FLG = 2 OR FLG = 4 THEN INPUT "After execution, press the enter key!.", DMY$

IF FLG < 3 THEN
  DELNUM = 13
ELSE
  D$ = INPUT$(34, #1) ' Obtain Scene Data Number (SCN) .
  PRINT #2, D$;
  SCN = VAL("&H" + RIGHT$(D$, 2))
  DELNUM=SCN * 336 + 2
END IF

FOR i = 1 TO DELNUM ' Transmit Data.
  DO
    D$ = INPUT$(1, #1)
    PRINT #2, D$;
    LOCATE 14, 1
    PRINT LOC(1), i

    LOOP WHILE D$ <> CHR$(10)
    LOCATE 13, 1
    PRINT "Transferring data....."
  NEXT i

LOCATE 20, 1 ' End Data Transmission .
PRINT "FINISH!"
CLOSE #1, #2
END

```

Appendix D

Menu Hierarchy Diagrams

This appendix provides menu hierarchy diagrams and references to sections of this manual where the related operations are explained.

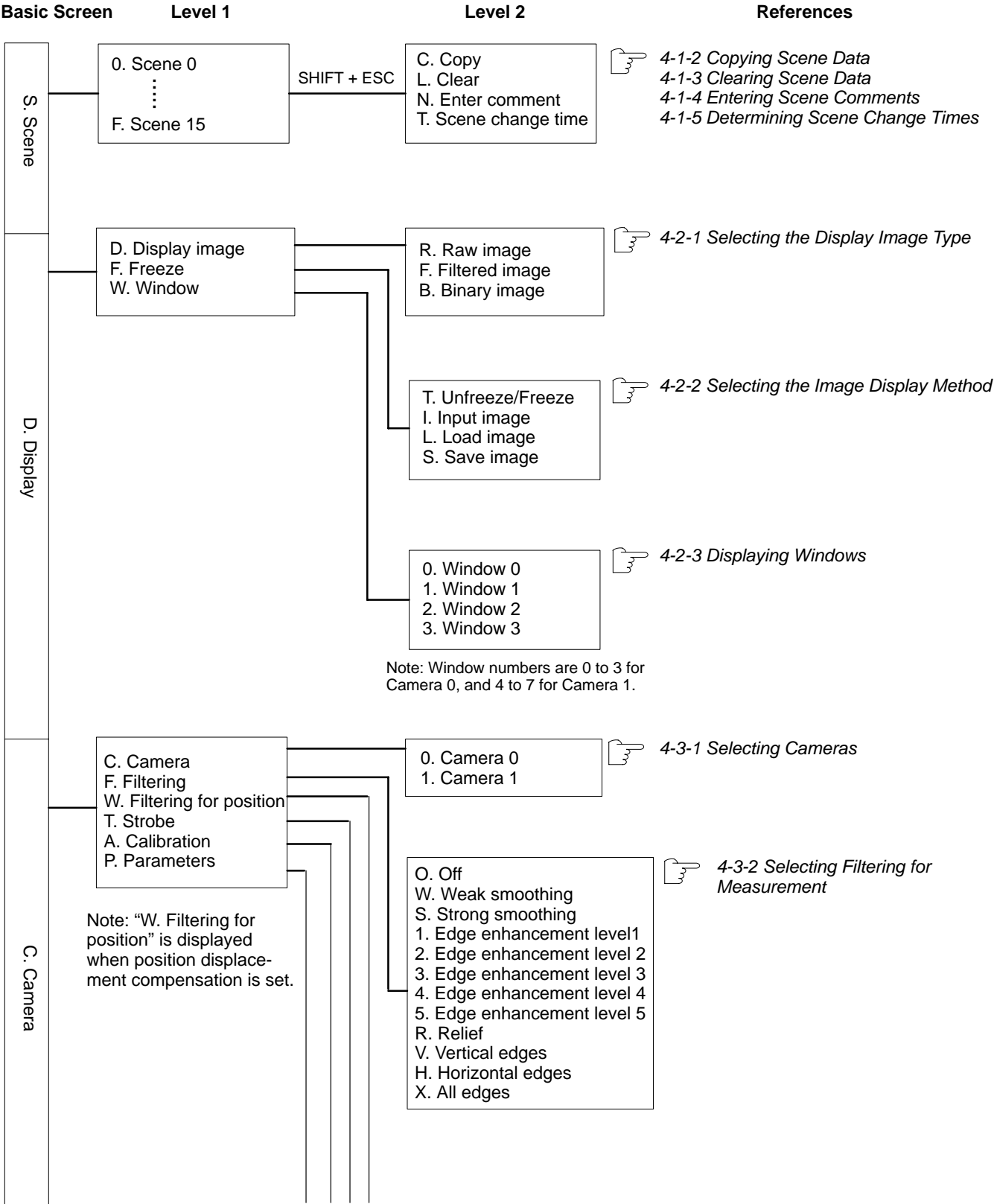

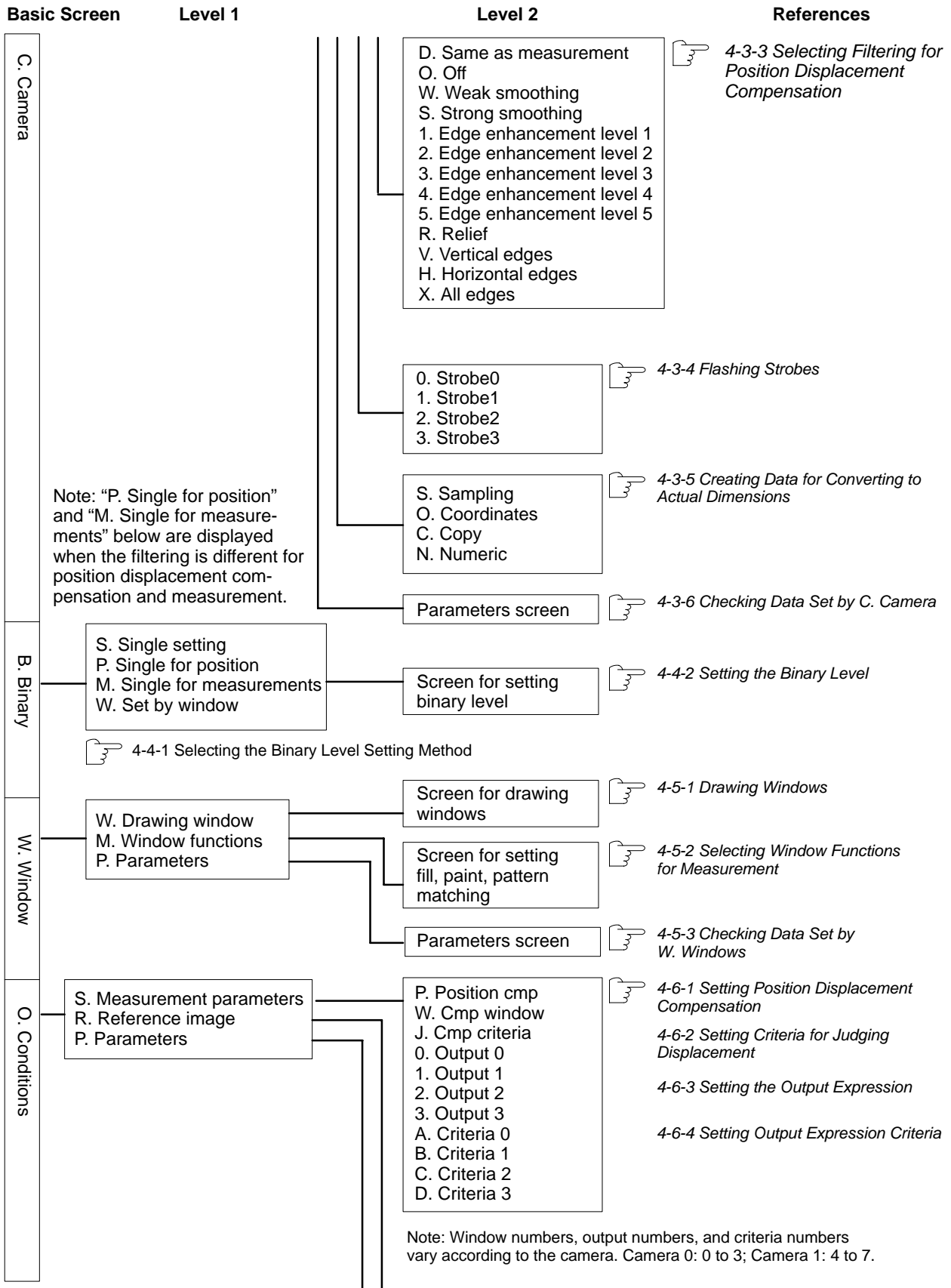

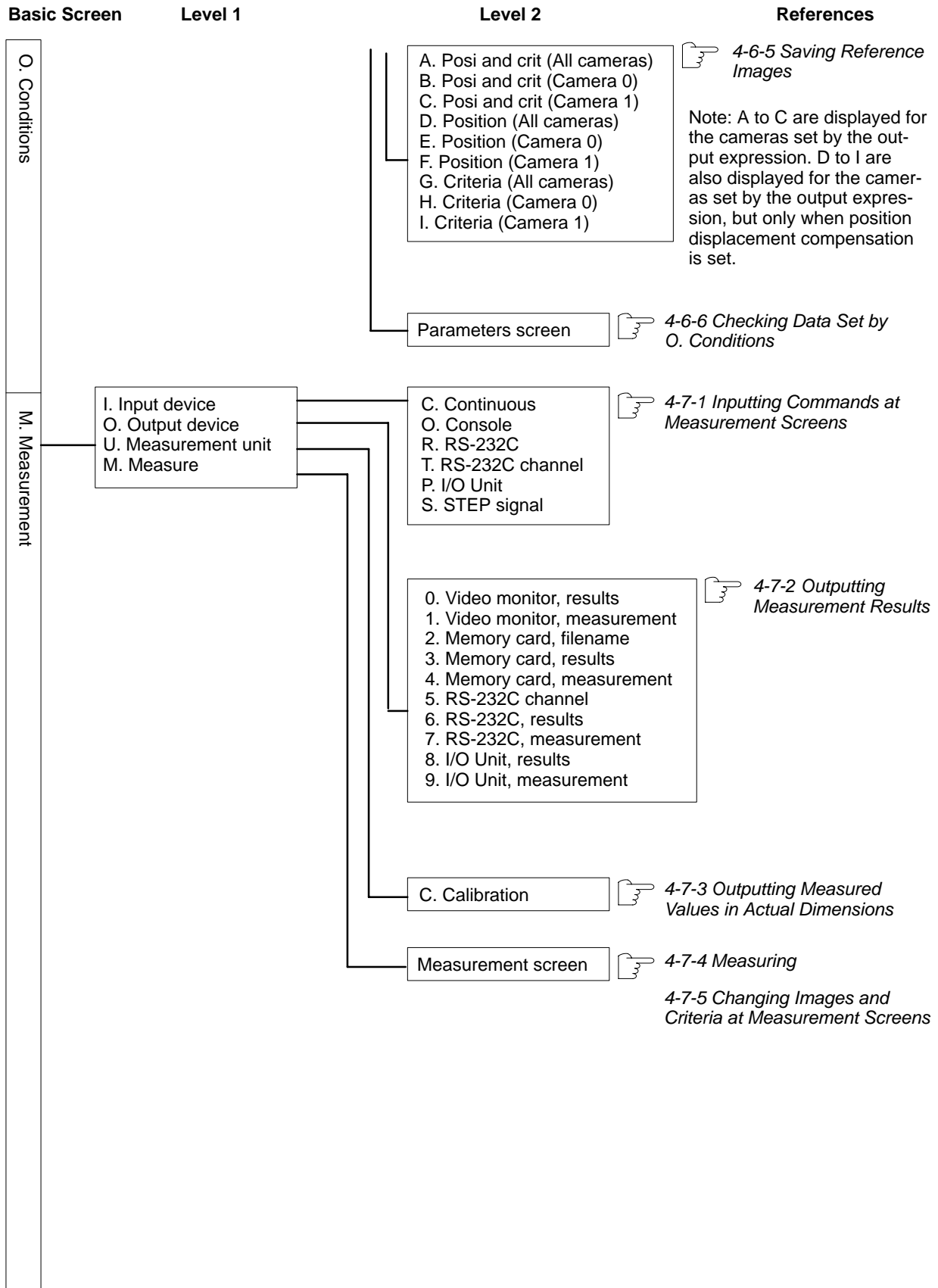

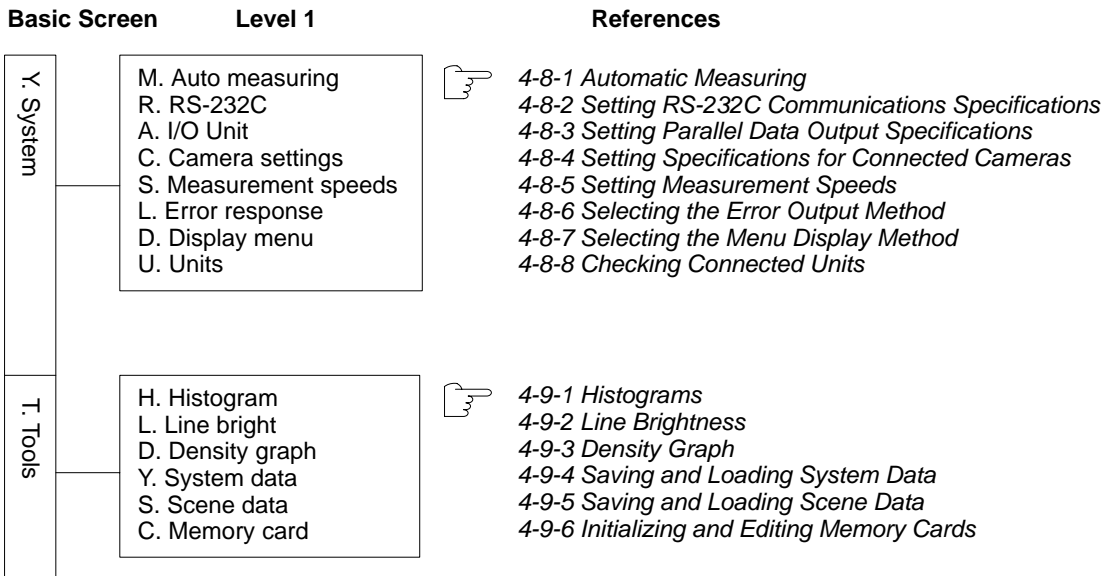

Index

A

- actual dimensions
 - converting to, 95
 - outputting, 152
- application programs, starting up, 190
- area, 3
 - measuring the, 127
- automatic measuring, 158
- axis angle, 3
 - measuring the, 127

B

- back-up battery, replacement, 192
- basic screen, 9
- binary, 3
- binary images, selecting, 81
- binary level, 105
 - changing at measurement screen, 154
 - set for two cameras, 105
 - setting, 106
 - setting by observing the binary image, 107
 - setting by observing the histogram, 107
 - setting by observing the line brightness, 108
 - setting methods, 105

C

- cables, specifications
 - monitor cable, 208
 - normal camera cable, 208
 - RS-232C cable, 209
 - shutter camera cable, 208
 - strobe cable, 209
- calibration, 4, 95
 - for two cameras, 96
 - methods, 96
- calibration data, setting, 97, 101
- camera angle, range, 103
- Camera I/F Units
 - dimensions, 45
 - specifications, 203
- camera X origin, range, 103
- camera Y origin, range, 103
- cameras
 - dimensions, 48
 - selecting, 90
 - specifications, 211
 - synchronization, 5

- CCTV lens, 215
- center of gravity, 5
 - measuring the, 127
- characters, inputting, 17
- checking data
 - set by C. Camera, 104
 - set by O. Conditions, 139
 - set by W. Window, 120
- command response, 159, 161
 - sample program, 223
- commands
 - change binary level, 141, 142
 - change criteria, 141, 143
 - change displayed image, 141
 - input timing, 140
 - load scene data, 143
 - load system data, 143
 - measure, 141, 145
 - measurement history, 141
 - obtain measured value, 144
 - quit measurement, 141, 142
 - reset, 141, 142
 - save reference image, 142, 145
 - save scene data, 142
 - save system data, 143
 - switch camera, 141
 - switch scene, 141, 145
- comments
 - for output expression, 133
 - for scene, 78
- communications
 - combining settings, 160
 - RS-232C specifications, 159
- connectors, crimped, 35
- Console, 7
 - dimensions, 47
 - keys, 7
 - specifications, 209
- continuous measurement, time charts, 219
- coordinate system, selecting, 96, 100
- criteria
 - changing at measurement screen, 155
 - for output expression, 134
 - for position displacement, 125
 - logic operation and output of judgement results, 149
 - setting with two cameras, 125

D

- density graph, 173
- dimensions, 45
 - lens, 215
- display image
 - changing at measurement screen, 156
 - changing from menus, 81
 - selecting, 81
- drawing modes, 110, 111
- Dummy Units
 - dimensions, 46
 - specifications, 208

E

- editing windows, 115
- errors, 193
 - at startup, 193
 - cameras, 194
 - clearing, 168
 - loading data, 168
 - memory card, 168
 - messages, 196
 - MMI Units, 194
 - output methods, 167
 - Parallel I/O Units, 195
 - position displacement compensation, 168
 - Power Supply Units, 193
 - RS-232C I/F Units, 195
 - saving data, 168
 - Strobe I/F Units, 195
 - Terminal Block Units, 195
 - video monitors, 194
- extension tubes, 5, 213
- external outputs, wiring, 39
- external power supply, wiring, 39

F

- fill measurement, 117
- filtered images
 - appearance of, 90
 - selecting, 81
- filtering
 - for measurement, 90
 - for position displacement compensation, 90, 93
 - for two cameras, 90, 94
- freeze, 83
- fuse, replacement, 192

G–H

- Ground, wiring, 36
- help message, displaying, 21
- histograms
 - how to read, 171
 - setting binary level, 107
 - with two cameras, 171

I

- image data
 - loading, 85
 - saving, 86
- image display method, selecting, 83
- imaging formula, 212
- IMP Units
 - dimensions, 45
 - specifications, 201
- initial screen, 9
 - clearing, 169
- input devices, 140
 - console, 141
 - continuous measurement, 140
 - I/O Unit, 145
 - procedure for selecting, 146
 - RS-232C, 141
 - STEP signal, 145
- inspection, 193
- installation
 - environment, 37
 - location, 37
 - noise, 37
 - precautions, 38
 - temperature, 37

L

- lens
 - CCTV, 215
 - dimensions, 215
 - field of vision, 216, 217
 - magnification, 213, 215
 - specifications, 212
 - types, 215
 - zoom, 215, 217
- line brightness
 - how to read, 172
 - setting binary level, 108
 - with two cameras, 172
- loading data, sample program, 224

M

magnification, range, 103
magnification lens, 215
maintenance, 192
measurement, 140
 automatic, 158
 conditions, 120
 displaying log, 156
 executing, 153
 speed, 166
measurement results, outputting, 146
Memory Cards, specifications, 212
memory cards
 application programs on, 190
 copying file, 185
 deleting file, 188
 initializing, 184
 loading from, 174, 179
 renaming file, 187
 saving to, 177, 182
 usable with F200, 184
menu hierarchy diagrams, 227
MMI Units
 dimensions, 45
 specifications, 201

N

Normal Camera I/F Units
 dimensions, 45
 specifications, 203
normal cameras
 description, 5
 dimensions, 48
 specifications, 211
Normal Simultaneously Camera I/F Units
 dimensions, 45
 specifications, 203
numbers, inputting, 15

O

optical charts, 5, 213
output devices
 I/O Unit, 148
 memory card, 150
 procedure for selecting, 152
 RS-232C, 147
 video monitor, 147
output expression, 126
 adding comments, 133
 changing the, 130
 setting criteria, 134
 setting with two cameras, 128

output specifications
 for parallel data, 162
 setting, 164

P

paint, 118
Parallel I/O Units
 connecting, 43
 dimensions, 46
 specifications, 206
 time charts, 220
pattern matching, 118
peripheral devices, connecting, 39
pixel, 5
position displacement compensation
 normal mode, 121
 saving position standard for compensating purposes, 136
 setting criteria, 125
 setting data, 120
 two window mode, 123
 with two cameras, 121, 123
Power Supply Unit
 dimensions, 45
 RUN and ERR signals, 39
 specifications, 202
 wiring, 36, 39
precautions, 38
processing time, displaying, 139

R

raw images, selecting, 81
reference images, saving, 136
resolution, 5
RS-232C
 loading via, 175, 180
 menu operation, 8
 saving via, 178, 183
 time charts, 220
RS-232C I/F Units
 connecting, 41
 dimensions, 46
 specifications, 207
RS-232C communications, setting specifications, 159

S

saving data, sample program, 224
scene change times, determining, 79
scene comments, entering, 78
scene data, 74
 clearing, 77
 copying, 75
 loading, 179, 180
 saving, 182, 183

scene numbers, selecting, 74

shutter cameras, description, 6

specifications

cables, 208

Camera I/F Units, 203, 204, 205

cameras, 211

Console, 209

Dummy Units, 208

IMP Units, 201

lens, 212

Memory Cards, 212

MMI Units, 201

parallel data output, 162

Parallel I/O Units, 206

Power Supply Unit, 202

RS-232C communications, 159

RS-232C I/F Units, 207

setting, for connected cameras, 165

Strobe I/F Units, 207

Terminal Block Units, 206

Video Monitor, 210

STEP signals

inputting image, 85

measurement, 145

saving reference images, 136

time charts, 220

wiring method, 43, 44

Strobe I/F Units

connecting, 40

dimensions, 46

specifications, 207

strobes, 6

changing strobe flash interval with binary level setting, 109

for two cameras, 95

timing, 94

system data, 157

loading, 174, 175

saving, 177, 178

T

Teleconverter, 218

Terminal Block Units

connecting, 43

dimensions, 46

specifications, 206

time charts

console, 220

continuous measurement, 219

Parallel I/O Units, 220

RS-232C, 220

STEP signals, 220

timing, for inputting commands, 140

troubleshooting, 193

U–V

unfreeze, 83

version, displaying, 21

Video Monitor

dimensions, 47

specifications, 210

W–Z

window functions, 117

fill measurement, 117

paint, 118

pattern matching, 118

setting functions with two cameras, 119

windows, 110

displaying, 87

drawing, 110

drawing methods, 112

drawing modes, 110, 111

drawing ring-shaped window, 111

drawing with two cameras, 114

editing, 115

generating window images, 114

graphic types, 112

zoom lens, 215

Revision History

A manual revision code appears as a suffix to the catalog number on the front cover of the manual.

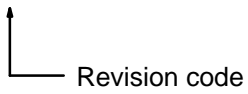
Cat. No. Z104-E1-1
 Revision code

The following table outlines the changes made to the manual during each revision. Page numbers refer to the previous version.

Revision code	Date	Revised content
1	March 1994	Original production