

USER'S MANUAL



K7L-UP-FLK **Liquid Leakage Position Sensor**

Preface

Thank you for purchasing the K7L-UP-FLK Liquid Leakage Position Sensor.

This manual provides information required for using the K7L-UP-FLK, such as information on functions, performance, procedures, and communications.

Observe the following precautions when using the K7L-UP-FLK.

- The K7L-UP-FLK is designed for use by qualified personnel with a knowledge of electrical systems.
- Read this manual carefully and make sure you understand it before attempting to operate the K7L-UP-FLK.
- Keep this manual in a safe location where it will be readily available for reference when required.

Notice

- (1) All rights reserved. No part of this manual may be reprinted or copied without the prior written permission of OMRON.
- (2) The specifications and other information in this manual are subject to change without notice for purposes of improvement.
- (3) Considerable care has been taken in the preparation of this manual; however, OMRON assumes no responsibility or liability for any errors or inaccuracies that may appear. In the event that a problem is discovered, please contact one of the OMRON offices or agents listed at the end of the manual, and provide the catalogue number shown on the cover of the manual.

The product names and company names that appear in this manual are the trademarks or registered trademarks of the respective company. The copyrights to the K7L-UP-FLK belong to OMRON Corporation.

Read and Understand this Manual

Please read and understand this manual before using the product. Please consult your OMRON representative if you have any questions or comments.

Warranty and Limitations of Liability

WARRANTY

OMRON's exclusive warranty is that the products are free from defects in materials and workmanship for a period of one year (or other period if specified) from date of sale by OMRON.

OMRON MAKES NO WARRANTY OR REPRESENTATION, EXPRESS OR IMPLIED, REGARDING NON-INFRINGEMENT, MERCHANTABILITY, OR FITNESS FOR PARTICULAR PURPOSE OF THE PRODUCTS. ANY BUYER OR USER ACKNOWLEDGES THAT THE BUYER OR USER ALONE HAS DETERMINED THAT THE PRODUCTS WILL SUITABLY MEET THE REQUIREMENTS OF THEIR INTENDED USE. OMRON DISCLAIMS ALL OTHER WARRANTIES, EXPRESS OR IMPLIED.

LIMITATIONS OF LIABILITY

OMRON SHALL NOT BE RESPONSIBLE FOR SPECIAL, INDIRECT, OR CONSEQUENTIAL DAMAGES, LOSS OF PROFITS OR COMMERCIAL LOSS IN ANY WAY CONNECTED WITH THE PRODUCTS, WHETHER SUCH CLAIM IS BASED ON CONTRACT, WARRANTY, NEGLIGENCE, OR STRICT LIABILITY.

In no event shall the responsibility of OMRON for any act exceed the individual price of the product on which liability is asserted.

IN NO EVENT SHALL OMRON BE RESPONSIBLE FOR WARRANTY, REPAIR, OR OTHER CLAIMS REGARDING THE PRODUCTS UNLESS OMRON'S ANALYSIS CONFIRMS THAT THE PRODUCTS WERE PROPERLY HANDLED, STORED, INSTALLED, AND MAINTAINED AND NOT SUBJECT TO CONTAMINATION, ABUSE, MISUSE, OR INAPPROPRIATE MODIFICATION OR REPAIR.

Application Considerations

SUITABILITY FOR USE

OMRON shall not be responsible for conformity with any standards, codes, or regulations that apply to the combination of products in the customer's application or use of the products.

At the customer's request, OMRON will provide applicable third party certification documents identifying ratings and limitations of use that apply to the products. This information by itself is not sufficient for a complete determination of the suitability of the products in combination with the end product, machine, system, or other application or use.

The following are some examples of applications for which particular attention must be given. This is not intended to be an exhaustive list of all possible uses of the products, nor is it intended to imply that the uses listed may be suitable for the products.

- Outdoor use, uses involving potential chemical contamination or electrical interference, or conditions or uses not described in this manual.
- Nuclear energy control systems, combustion systems, railroad systems, aviation systems, medical equipment, amusement machines, vehicles, safety equipment, and installations subject to separate industry or government regulations.
- Systems, machines, and equipment that could present a risk to life or property.

Please know and observe all prohibitions of use applicable to the products.

NEVER USE THE PRODUCTS FOR AN APPLICATION INVOLVING SERIOUS RISK TO LIFE OR PROPERTY WITHOUT ENSURING THAT THE SYSTEM AS A WHOLE HAS BEEN DESIGNED TO ADDRESS THE RISKS, AND THAT THE OMRON PRODUCTS ARE PROPERLY RATED AND INSTALLED FOR THE INTENDED USE WITHIN THE OVERALL EQUIPMENT OR SYSTEM.

PROGRAMMABLE PRODUCTS

OMRON shall not be responsible for the user's programming of a programmable product, or any consequence thereof.

Disclaimers**CHANGE IN SPECIFICATIONS**

Product specifications and accessories may be changed at any time based on improvements and other reasons.

It is our practice to change model numbers when published ratings or features are changed, or when significant construction changes are made. However, some specifications of the products may be changed without any notice. When in doubt, special model numbers may be assigned to fix or establish key specifications for your application on your request. Please consult with your OMRON representative at any time to confirm actual specifications of purchased products.

DIMENSIONS AND WEIGHTS

Dimensions and weights are nominal and are not to be used for manufacturing purposes, even when tolerances are shown.

PERFORMANCE DATA

Performance data given in this manual is provided as a guide for the user in determining suitability and does not constitute a warranty. It may represent the result of OMRON's test conditions, and the users must correlate it to actual application requirements. Actual performance is subject to the OMRON Warranty and Limitations of Liability.

ERRORS AND OMISSIONS

The information in this document has been carefully checked and is believed to be accurate; however, no responsibility is assumed for clerical, typographical, or proofreading errors, or omissions.

Safety Precautions





■ Definition of Precautionary Information

The following notation is used in this manual to provide precautions required to ensure safe usage of the K7L-UP-FLK. The safety precautions that are provided here are extremely important to safety. Always read and heed information provided in all safety precautions. The following notation is used.

 Caution	Indicates a potentially hazardous situation which, if not avoided, may result in minor or moderate injury or in property damage.
--	--

Note: "Property damage" refers to the damage or destruction of property, including buildings, household effects, livestock, or pets.

● Cautions

 Caution	
Tighten the terminal screws to the recommended torque of 0.5 to 0.6 N·m. Failure to do so may occasionally cause physical damage due to fire.	
Do not use the product in an environment with flammable or explosive gas. Doing so may occasionally cause minor or moderate personal injury or physical damage due to explosion.	
Do not touch the terminals while the power is ON. Doing so may occasionally cause electric shock.	
Do not open the top or side covers of the case or remove masking seals. Doing so may occasionally cause electric shock or physical damage to the product.	
Do not disassemble, repair, or modify the product. Doing so may occasionally cause electric shock, minor injury, fire, or damage to the product.	

Safety Precautions

1. Do not use, store, or transport the product in the following environments.
 - Locations exposed to direct sunlight
 - Outdoor locations or locations exposed to wind or rain
 - Locations with temperatures or humidity outside of the specified range
 - Locations subject to condensation
 - Locations subject to sudden changes in temperature or humidity
 - Locations subject to strong vibration or shock
 - Locations where the product will be exposed to water spray, oil, or saltwater
 - Locations exposed to corrosive gas (particularly sulfuric acid gas, ammonia gas, etc.)
 - Locations with excessive dust and dirt
2. When mounting to a DIN Track, make sure that there are no loose screws and that the product is securely mounted. If screws come loose, the DIN Track, the product, or wiring may be shaken loose due to vibration or shock.
3. Use a DIN Track that is 35 mm in width (OMRON model number: PFP-50N/-100N).
4. When surface mounting, use M4 screws and tighten the screws to the specified torque of 1.03 N·m max.
5. Check to make sure there are no mistakes in the specifications or wiring before turning ON the power.
6. Make sure that the power supply voltage and the load are within the specifications and ratings.
7. Use the following crimp terminals for wiring. (Phoenix Contact)
 - Connecting Cable: AI 0.25-6BU
 - Other cables: AI 0.34-8TQ (AWG22)
 - AI 0.5-8WH (AWG20)
 - AI 0.75-8GY (AWG18)
8. Do not pull on the cables.
9. Conduct operation tests before using the product.
10. Install an external switch or circuit breaker that complies with applicable IEC 60947-1 and IEC 60947-3 requirements, and label it clearly so that the operator can quickly turn OFF the power.
11. Do not use the product in locations subject to static electricity or electric fields.
12. Install the product as far away as possible from devices that generate strong high frequency or surges.
13. To prevent inductive noise, separate the wiring for the product from high-voltage or high-current power lines. In addition, do not route the wiring for the product in parallel with or bundled with power lines. Using separate conduits or ducts and shielded cables can also be effective.
14. Do not allow pieces of metal, wire clippings, or fine metallic shavings or filings from installation to enter the product.
15. Do not install the product near heat-producing devices (such as devices with coils or windings).
16. Do not connect anything to unused terminals.
17. Firmly secure the connectors for Connecting Cables, Junction Cables, Sensing Cables, Area Separators, and Terminators.
18. Do not clean the product with paint thinners. Use commercial alcohol.
19. Dispose of the product as industrial waste.
20. Touch a grounded metal object to discharge static electricity from your body before touching any part of the Liquid Leakage Position Sensor.

Precautions for Correct Use

1. Use the following OMRON products for leakage detection.
 - Sensing Cable: F03-16UP-C-□M
 - Connecting Cable: F03-21UP-CC
 - Junction Cable: F03-21UP-JC
 - Area Separator: F03-20UP-AS
 - Terminator: F03-20UP-TC
2. After a leak has been detected, wipe the fluid from the Sensing Cable. If the Sensing Cable deteriorates despite being wiped off, then replace it.
3. Do not subject Sensing Cables, Connecting Cables, Junction Cables, Area Separators, or Terminators to vibration or shock.
4. When laying cable in a place where people pass through, use a protective duct.
5. Do not install the connectors on the Sensing Cables or the Connecting Cables, Junction Cables, Area Separators, or Terminators in the areas where leaks are being detected. If chemical solution adheres to any of these, replace them.
6. Do not install the Sensing Cable where it will be pressed against a metal edge.
7. Warm up the Liquid Leakage Position Sensor for at least 15 minutes after turning ON the power.
8. Do not bend or tightly tie up extra Sensing Cable.
9. Be sure that you understand the manual before making device settings. To short-circuit the Sensing Cable, press a commercially available metal brush against the Sensing Cable for at least 45 s.
10. This product detects changes in the electrical resistance of liquids. The performance of the product specified in this document may not be obtained for some types of liquids. Always perform tests in advance before purchasing the product to confirm applicability.

Revision History

A manual revision code appears as a suffix to the catalog number on the cover of the manual.

Cat. No.

H161-E1-02

Revision code

The following table outlines the changes made to the manual during each revision. Page numbers refer to the previous version.

Revision code	Date	Revised content
01	May 2009	Original production (PDF only)
02	October 2009	Added the F03-20UP-AS Area Separator.



About this Manual

■ Manual Structure

This manual is organized according to descriptions of procedures for the K7L-UP-FLK and communications. Refer to the sections that are relevant to the system that is to be used.

CONTENTS

	Preface	i
	Safety Precautions	iv
	Safety Precautions	v
	Precautions for Correct Use	vi
	Revision History	vii
	About this Manual	viii
	CONTENTS	ix
Section 1	Overview	1-1
	1.1 K7L-UP-FLK Functions and Features	1-2
	1.2 Main Applications	1-4
	1.3 Part Names and Functions	1-6
	1.4 Internal Block Diagram	1-8
Section 2	Preparations for Operation	2-1
	2.1 Mounting	2-2
	2.2 Using the I/O Section	2-4
	2.3 Connecting and Securing Cables	2-8
	2.4 Cable Connection Example	2-12
Section 3	Basic Procedures	3-1
	3.1 Basic Setup	3-2
	3.2 Overview of Operation	3-8
	3.3 Procedures When Problems Are Detected	3-10
	3.4 Operation Timecharts	3-13
Section 4	Functions and Procedures	4-1
	4.1 Setup Procedures	4-2
	4.2 Checking Parameters	4-6
	4.3 Setting the Date and Time	4-7
	4.4 Setting the Language	4-9
	4.5 Setting the Detection Sensitivity	4-11
	4.6 Enabling the Zero Shift	4-13
	4.7 Setting the Zero Shift	4-15
	4.8 Enabling the Correction	4-17
	4.9 Setting the Correction	4-19
	4.10 Setting Detection Areas	4-21
	4.11 Editing Detection Areas	4-23
	4.12 Deleting Detection Areas	4-30
	4.13 Setting the Relay Output Method	4-32
	4.14 Setting the Output Reset Method	4-34
	4.15 Setting Communications	4-36
	4.16 Setting the Linear Output (4 to 20 mA)	4-38
	4.17 Output Test Method for the Leak Detection Test	4-40

4.18	Output Test Method for the Disconnection Detection Test	4-42
4.19	Output Test Method for the Error Detection Test.....	4-44
4.20	Setting the Backlight ON Time.....	4-45
4.21	Checking the Event Logs.....	4-47
4.22	Checking System Information	4-49
4.23	Initialization Method.....	4-50
4.24	Short-circuiting a Sensing Cable	4-52
4.25	Copy Function when Setting Distances	4-53
4.26	Setting Protection.....	4-55
Section 5	Communications Methods	5-1
5.1	Overview of Communications Methods	5-2
Section 6	CompoWay/F Communications Procedure	6-1
6.1	Data Format	6-2
6.2	Command Text Structure.....	6-6
6.3	Service Details	6-9
6.4	List of Response Codes.....	6-20
Section 7	Communications Data for CompoWay/F Protocol	7-1
7.1	Variable Area Parameters and Setting/Monitor Ranges	7-2
7.2	Status	7-8
7.3	Possible Communications Range.....	7-9
Section 8	Modbus Communications Protocol	8-1
8.1	Data Format	8-2
8.2	List of Functions	8-6
8.3	Variable Areas	8-7
8.4	Service Details	8-8
Section 9	Communications Data for Modbus Protocol	9-1
9.1	Variable Area Parameters and Setting/Monitor Ranges	9-2
9.2	Status	9-17
9.3	Possible Communications Range.....	9-18
Section 10	Troubleshooting	10-1
10.1	Troubleshooting.....	10-2
Appendices	A-1
A.1	Product Specifications	A-2
A.2	Table of Parameters	A-7
A.3	Table of Characters.....	A-8



Section 1

Overview

1.1	K7L-UP-FLK Functions and Features	1-2
1.2	Main Applications.....	1-4
1.3	Part Names and Functions.....	1-6
1.4	Internal Block Diagram.....	1-8

1.1 K7L-UP-FLK Functions and Features

■ Main Features

The K7L-UP-FLK Liquid Leakage Position Sensor detects liquid leaks and displays the positions of the leaks. The main features of the Sensor are described below.

● Liquid Leakage Monitoring

- Detection of Changes in Liquid Leaks
 - (1) Leak Spreading
Any spreading of a leak from the current position is detected.
 - (2) Second Leaks
A leak at a separate position from the current leak position is detected.

- Up to 600 m of Cable
Up to 600 m of Cable can be connected by combining Sensing Cables with other cables.
When Cables are connected, the length of Sensing Cable is automatically displayed.
The length of the F03-21UP-JC Junction Cables is not included in the displayed cable length.
The distance displayed for each Area Separator is equivalent to 10 m of Sensing Cable.

- Detection Sensitivity Setting
Two levels of leakage detection sensitivity can be selected.

- Disconnection Detection
Cable disconnections from the Sensor to the Terminator are detected.

● Inputs

- Input Compensation Functions
 - (1) Zero Shift
The 0-m position on the Sensing Cable can be shifted with this setting. If there is a distance between the Sensor and the position where a leak is detected, the display can be made easier to understand by changing any distance to 0 m.

 - (2) Correction
The total length of the Cables can be changed to any value. If there is a discrepancy between the actual length and the measured length of Cables due to measurement error, the measurement value can be changed to any value for compensation.

- Area Settings
Leak positions in meters can be divided into up to 20 areas.
F03-20UP-AS Area Separators can be used to enable accurately identifying the detection area in which a leak has occurred even when the leak occurs near an area boundary.

● Outputs

- Relay Output Type
Relay outputs can be set to normally open or normally closed operation.
- Output Reset
Any of three event reset patterns can be selected to reset the output.
- RS-485 Communications
Remote monitoring is possible using communications. Either CompoWay/F or Modbus can be selected as the communications protocol.
- Linear Output
A 4 to 20-mA output can be selected according to the event.

● Other Functions

- Language
Select either English or Japanese as the display language.
Note: The default language is English.
- Date and Time Information
Pre-setting the date and time enables event times to be saved in the event log. In addition, leap years are included so there is no need to reset the date and time information.
- Output Test
The output can be tested without connecting a Sensing Cable.
- Backlight Time Setting
The backlight can be set to always remain ON or to turn OFF after a specified time.
- Key Protection
Unintended setting changes can be prevented by using key protection.
- Event Log
Event contents and timestamps are stored for up to 20 events.
- Initialization
The settings can be returned to their default values.

1.2 Main Applications

Semiconductors/FPD Factories

Large quantities of pure water and chemical solutions are used in semiconductor and FPD factories. Here, production rates can be improved by rapid detection and restoration of liquid leakage positions.

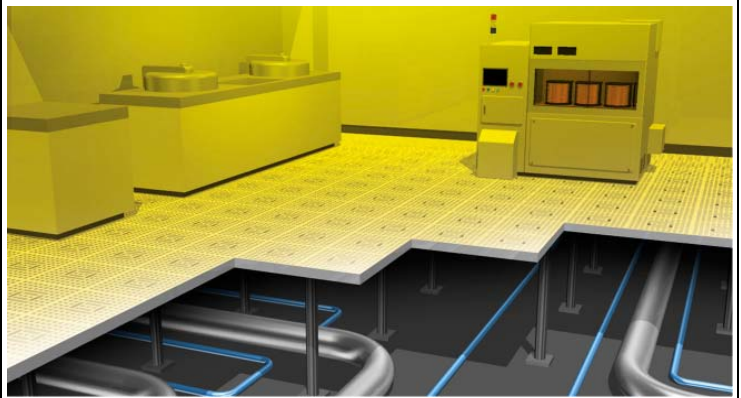

IDCs (Internet Data Centers)

Humidity is constantly controlled to maintain equipment in an IDC. Here, liquid leakage from air conditioning can be held to a minimum.



Computer Centers

Humidity is constantly controlled to maintain equipment in a computer center. Here, liquid leakage from air conditioning can be held to a minimum.



Telecommunications Exchanges

Humidity is constantly controlled to maintain equipment in a telecommunications exchange. Here, liquid leakage from air conditioning can be held to a minimum. At the same time, liquid leakage from the large-capacity lead storage batteries for power interruptions can be monitored.



Chemical and Pharmaceutical Factories

Underground soil contamination and damage outside of the factory from chemical solutions can be held to a minimum in chemical and pharmaceutical factories.



Public Facilities (Art Museums, Public Museums, and Libraries)

Sprinkler systems are normally installed for fire protection in a public facility. Here, secondary damage from sprinklers that are broken in an earthquake can be held to a minimum.



Banks

In a bank, water leakage damage to valuables such as documents and works of art in underground safety deposit boxes can be held to a minimum. Secondary damage from sprinklers that are broken in an earthquake can also be minimized.



Hospitals

Large amounts of water are used for surgery and dialysis in a hospital, so water storage tanks are installed in case the water supply should be interrupted. Here, water leakage from the storage tanks can be monitored. In addition, secondary damage from sprinklers that are broken in an earthquake can be held to a minimum.



1.3 Part Names and Functions

● Controls

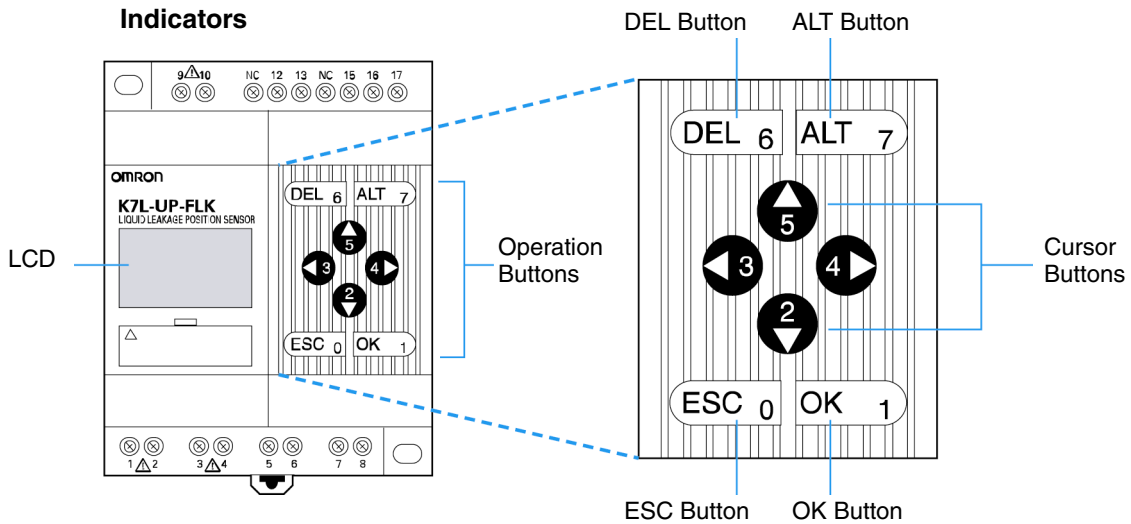

Button	Name	Function	
		Menu selection	Parameter setting
	DEL Button	–	Deletes the characters or setting.
	ALT Button	–	Use in combination with another button.
	UP Button	Moves the selected item up.	Moves the selected item up. Moves the number or character forward.
	DOWN Button	Moves the selected item down.	Moves the selected item down. Moves the number or character backward.
	LEFT Button	–	Moves the selected item to the left.
	RIGHT Button	–	Moves the selected item to the right.
	ESC Button	Returns to the previous screen.	Discards the setting and returns to the previous step.
	OK Button	Enters the selected item.	Enters the setting.

Note: The above functions are provided as examples. For details, refer to Section 4 Functions and Procedures.

● Icons

Icon	Description
RUN	Displayed while monitoring for leaks.
ERR	Displayed when there is an error in the system.
▲	Displayed when there are menu items or display contents above the present display position.
▼	Displayed when there are menu items or display contents below the present display position.
○⊕	Displayed when protection is set.

1.4 Internal Block Diagram

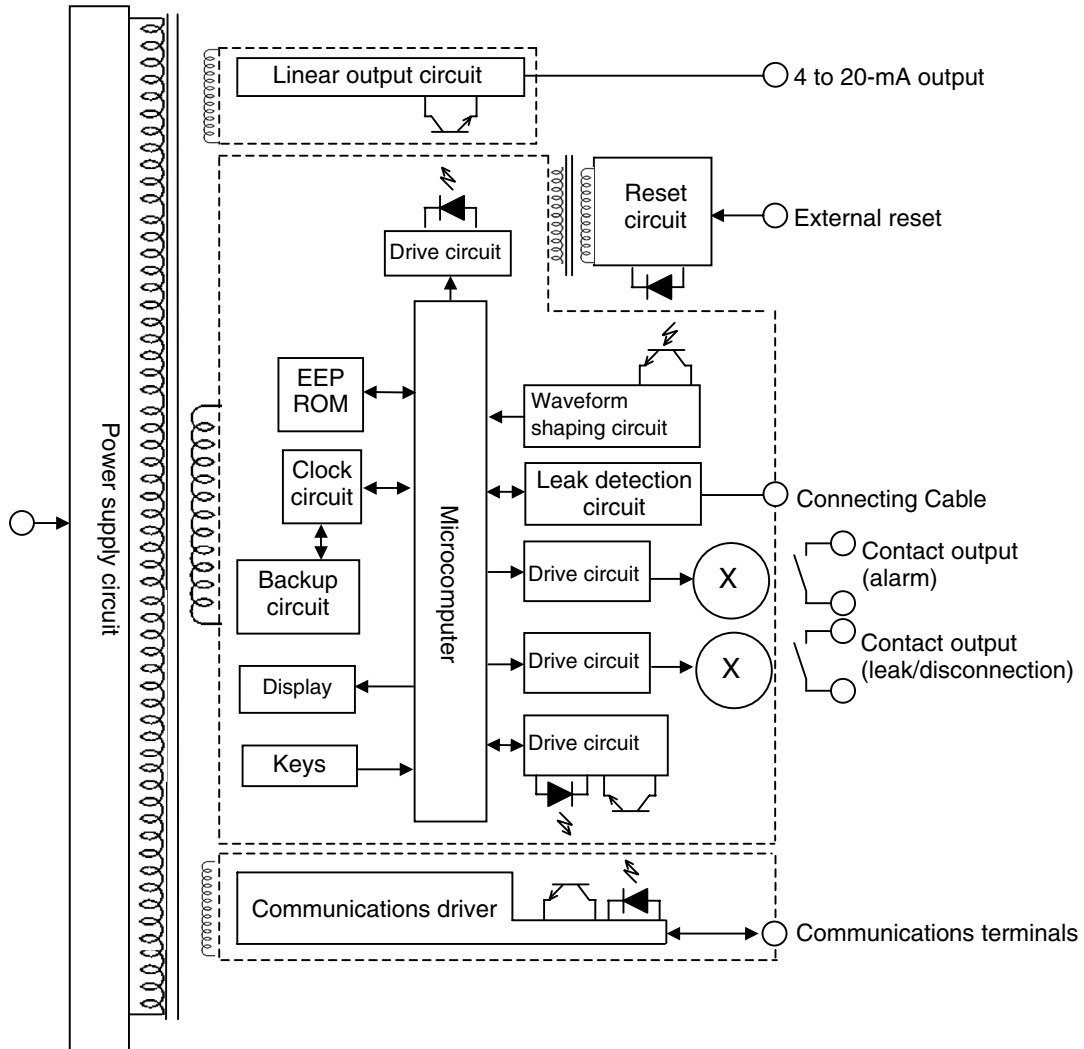



Section 2

Preparations for Operation

2.1	Mounting.....	2-2
2.2	Using the I/O Section.....	2-4
2.3	Connecting and Securing Cables.....	2-8
2.4	Cable Connection Example.....	2-12

2.1 Mounting

■ Dimensions (Unit: mm)

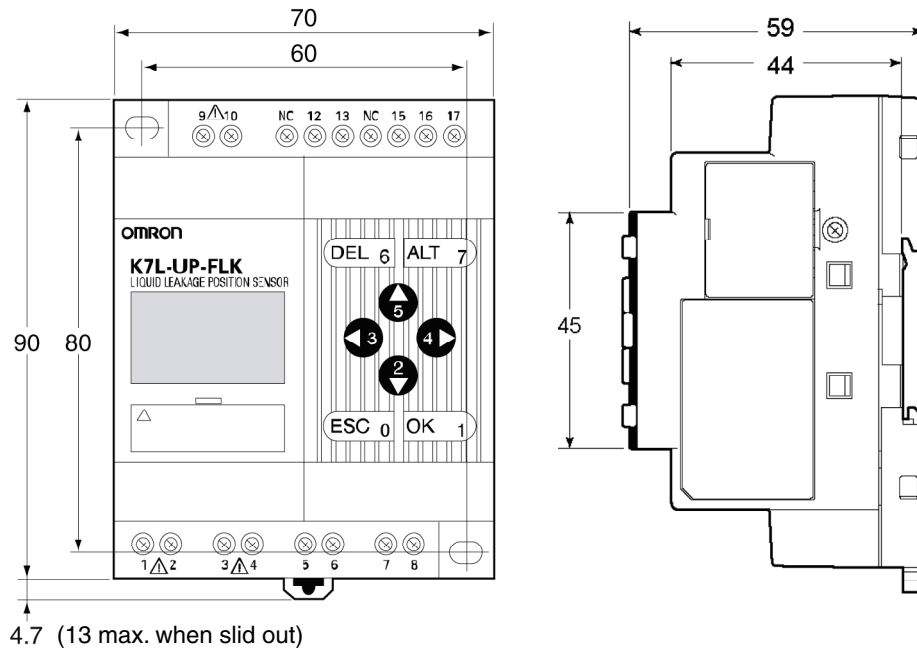

■ Mounting the Sensor

• Mounting to a DIN Track

Pull down the hook on the bottom of the Sensor, latch the hook at the top of the Sensor on the DIN Track, and then press until the hooks lock into place.

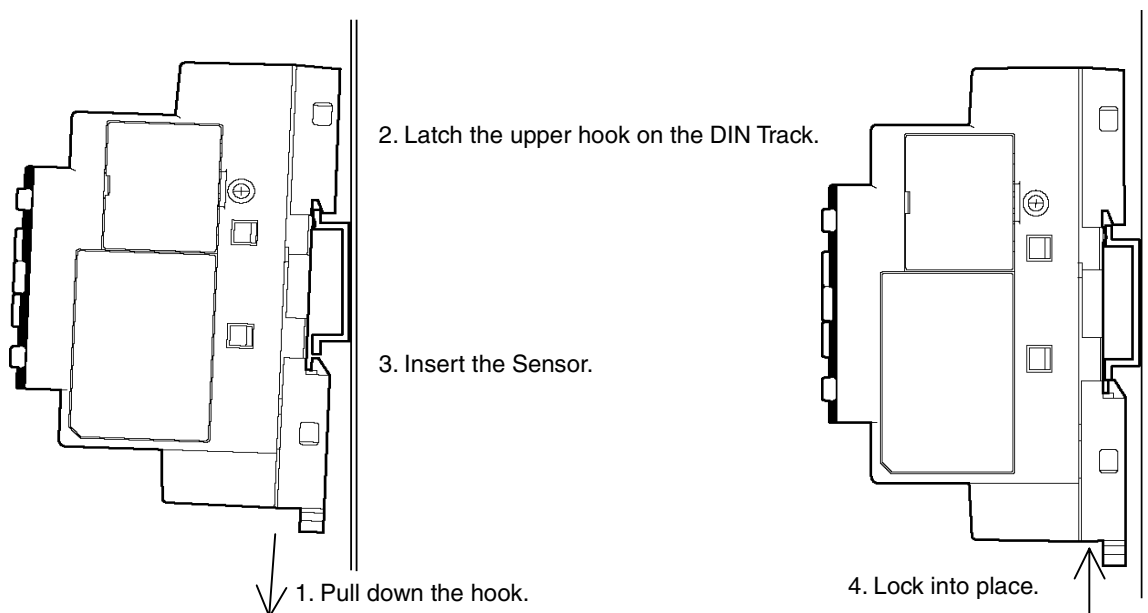

• Removing the Sensor

Use a tool such as a flat-blade screwdriver to release the hook, and then pull out and up on the Sensor from the bottom.

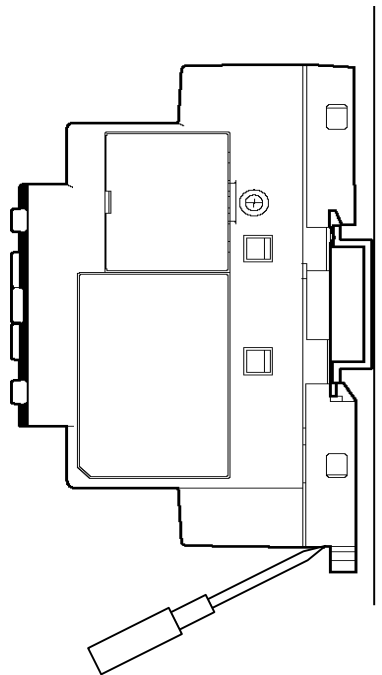

Note: Mounting Track

- DIN Track PFP-100N (1,000 mm)
- PFP-50N (500 mm)

• Surface Mounting

Use M4 screws.

Tightening torque: 1.03 N·m max

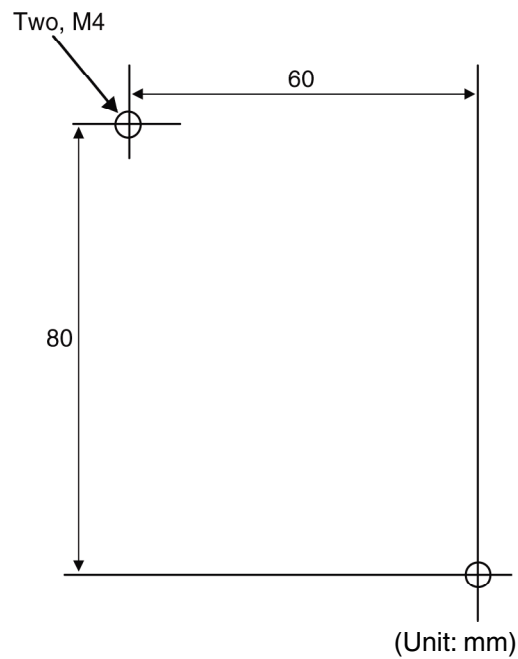
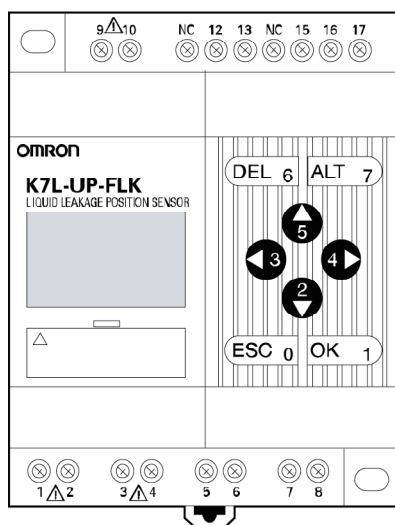

2.2 Using the I/O Section

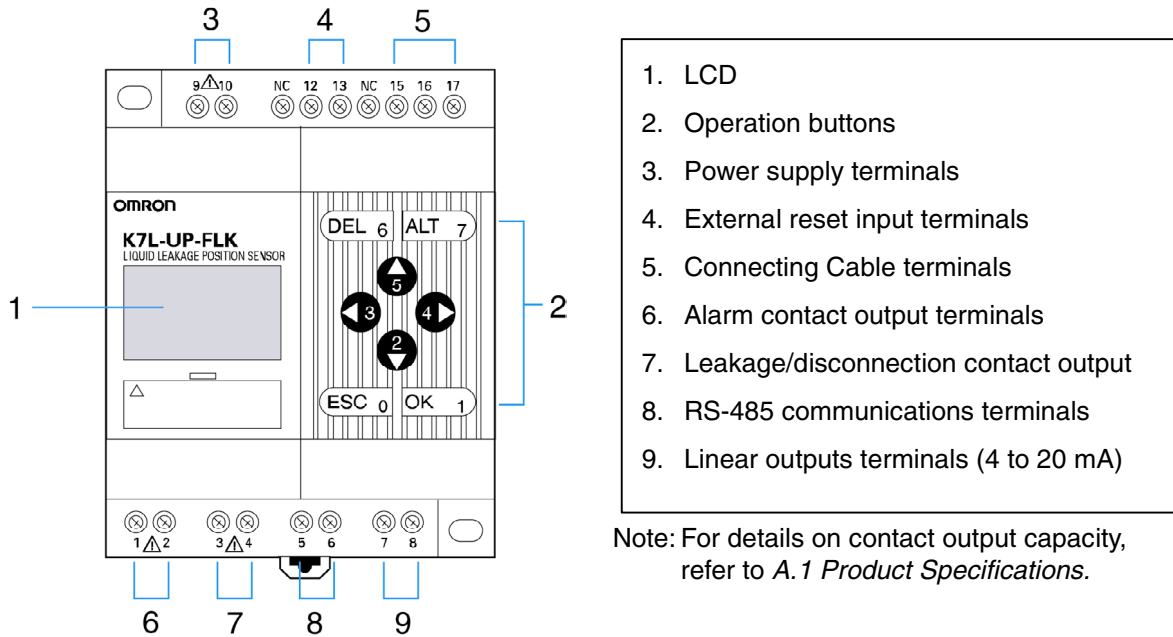

Note: For details on contact output capacity, refer to A.1 Product Specifications.

Top Row

9	10	NC	12	13	NC	15	16	17
---	----	----	----	----	----	----	----	----

Bottom Row

1	2	3	4	5	6	7	8
---	---	---	---	---	---	---	---

Bottom row		Top row	
Terminal No.	Terminal name	Terminal No.	Terminal name
1	Alarm contact output	9	Power supply input
2	Alarm contact output	10	Power supply input
3	Leakage/disconnection contact output	NC	Unused terminals
4	Leakage/disconnection contact output	12	External reset input
5	RS-485 B (+)	13	External reset input
6	RS-485 A (-)	NC	Unused terminals
7	Linear outputs (+)	15	Detection wire in Connecting Cable (red)
8	Linear outputs (-)	16	Resistance wire in Connecting Cable (white)
		17	Signal wire in Connecting Cable (black)

Note: Do not connect anything to unused terminals.

■ Sensor Wiring

● Recommended Crimp Terminals

Ferrules with Plastic Insulating Collars			Twin Ferrules with Plastic Insulating Collars		
Model	Color	AWG	Model	Color	Cross-sectional area
Al 0.25-6BU	Blue	24			
Al 0.34-8TQ	Blue-green	22	Al-TWIN 2X0.5-8WH	White	2 × 0.5
Al 0.5-8WH	White	20	Al-TWIN 2X0.75-8GY	Gray	2 × 0.75
Al 0.75-8GY	Gray	18	Al-TWIN 2X1-8RD	Red	2 × 1
Al 1.0-8RD	Red	18	Al-TWIN 2X1.5-8BK	Black	2 × 1.5
Al 1.5-8BK	Black	16			
Al 2.5-8BU	Blue	14			

Note: 1. Use wires with a heat resistance of at least 70°C.

2. Tighten the terminals to a torque of 0.5 to 0.6 N·m.

● Recommended Tools

- Flat-blade Screwdriver
 Maker: Phoenix Contact
 Model: SZS 0.6x3.5

- Ferrule Crimp Tools
 Maker: Phoenix Contact
 Model: CRIMPFOX UD6
 Recommended cable diameter: AWG10 to AWG24

• Power Supply

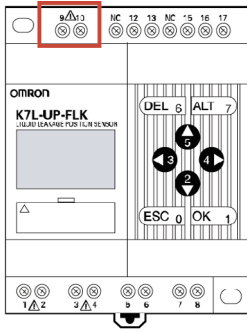

Input the power supply to terminals 9 and 10. The power supply specifications are as follows:

100 to 240 VAC, 50/60 Hz, 10 VA max. (maximum load)

• Connecting Cables

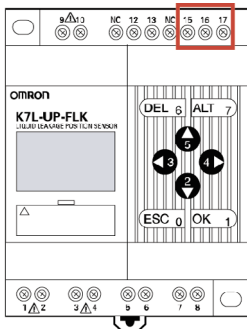

Connect the Connecting Cable to terminals 15, 16, and 17. The connection specifications are as follows:

- ⑮ → Detection wire (red)
- ⑯ → Resistance wire (white)
- ⑰ → Signal wire (black)

• External Reset

External event resets are enabled by connecting terminals 12 and 13. Do not connect a load.

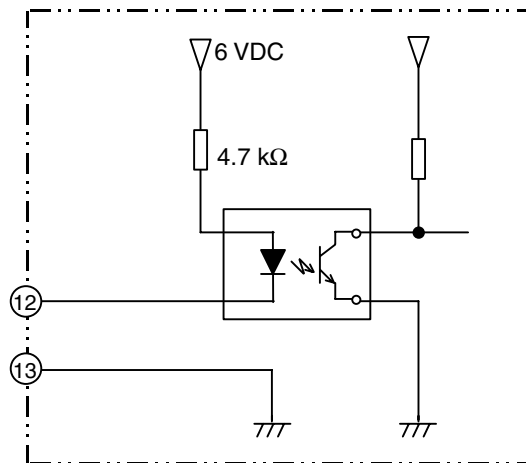
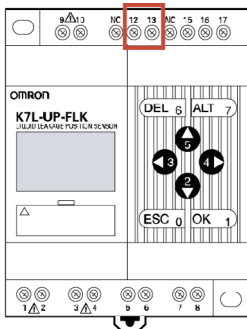

• Relay Output

Connect loads to terminals 1 and 2 or to terminals 3 and 4.

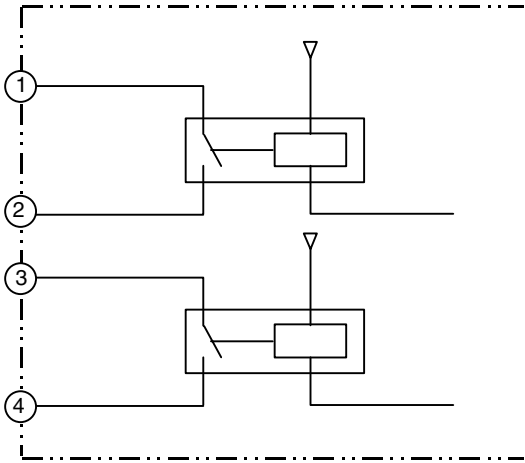
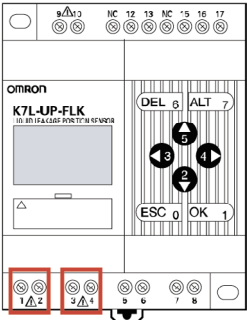

• RS-485

Connect an RS-485 communications host device to terminals 5 and 6.

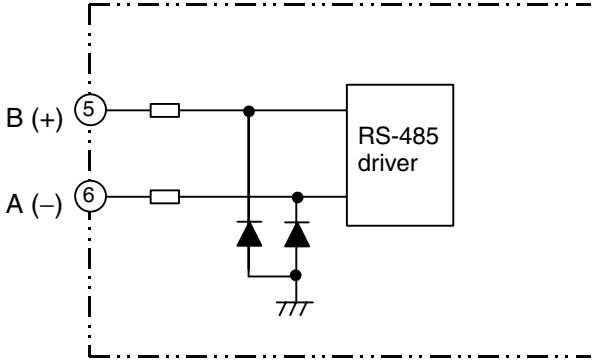
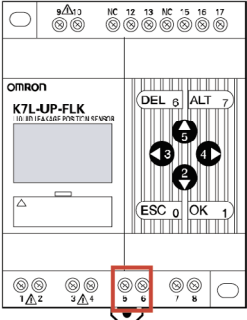

• Linear Output

A linear current is output from terminals 7 and 8. Connect a load within the specified range.

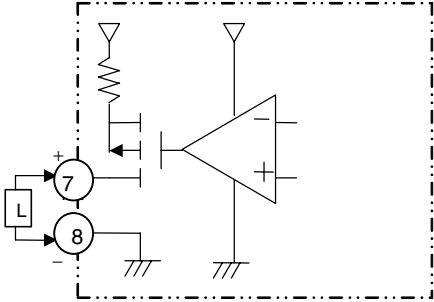
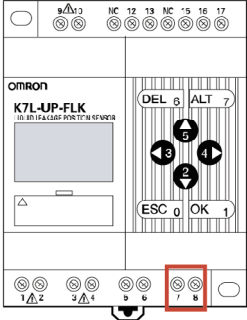

Note: The maximum load resistance for the linear output is 500 Ω.

2.3 Connecting and Securing Cables

- **Connecting Cable Connectors**

Note: Sensing Cables have an inherent error. Be sure to set the zero shift and correction value when installing or adding Sensing Cables.

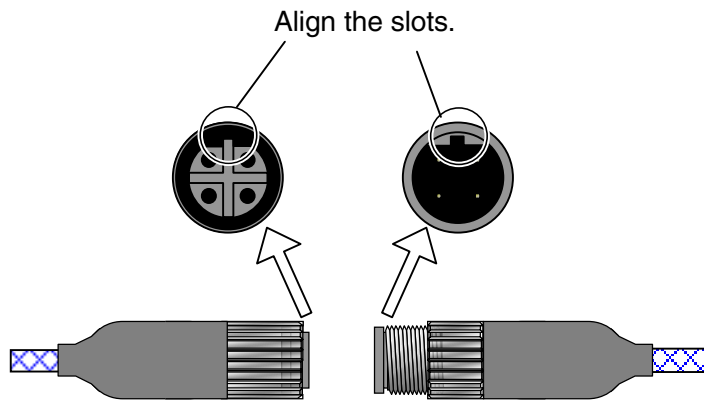

Align the positions of the slots on the male (plug) and female (socket) connectors and press the connectors together.

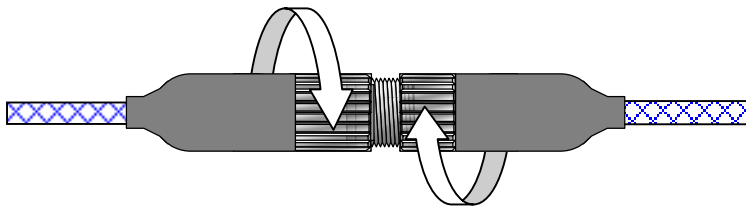

Secure the connection by turning the threaded ends of the connectors in the directions of the arrows.

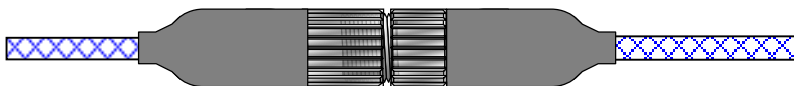

To disconnect the connectors, reverse the above procedure.

- **Connecting the Terminator**

Note: A Terminator must be connected at the end of the Cable. The Sensor will not operate normally if a Terminator is not connected.

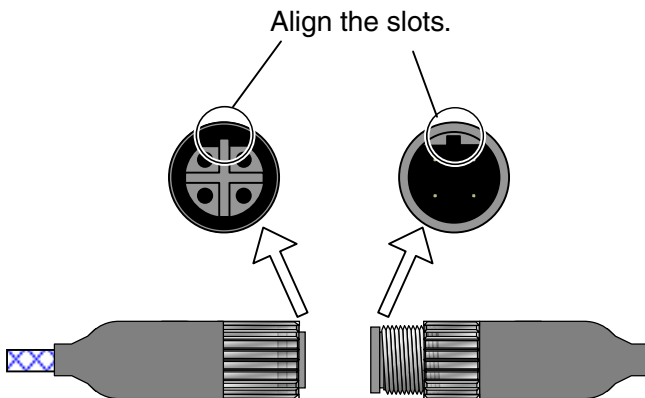

Align the positions of the slots on the Sensing Cable connector (female, socket) and the Terminator connector (male, plug) and press the connectors together.

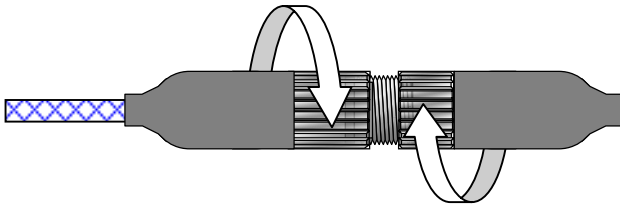

Secure the connection by turning the threaded ends of the connectors in the directions of the arrows.



To disconnect the connectors, reverse the above procedure.

- **Extending the Cable with Connecting and Junction Cables**

Note: When adding a Cable, do not exceed the maximum total cable length of 600 m.

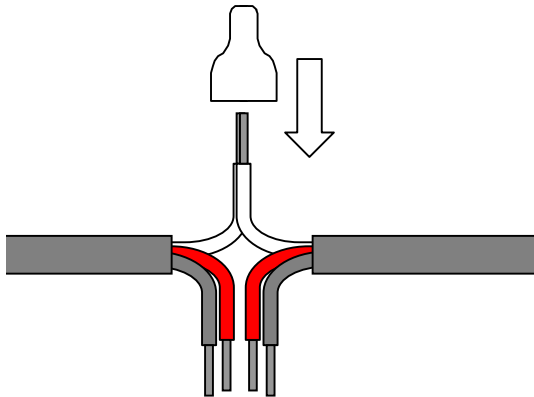

Strip the insulation from the 3-wire cable, align the wires, and attach a crimp terminal. Matching the wire colors makes it easy to understand the signal wire, resistance wire, and detection wire connections for Connecting Cables and Junction Cables.

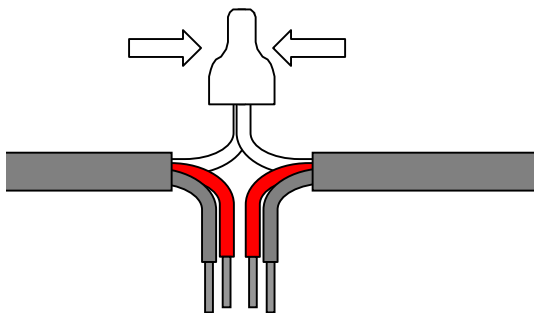

Crimp the terminal, using the special crimp tool for the terminal that is being used.

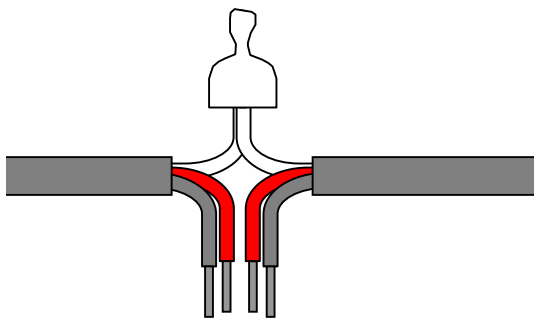

Crimp the other wires in the same way.

When crimping a crimp terminal that has no insulation sleeve, be sure to apply insulating tape or some other means of insulation after all the wires have been crimped.

• Securing the Cables

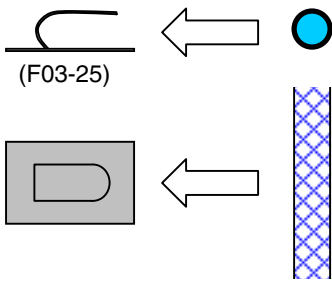

Insert each cable through the hooks of an F03-25 Sensing Band Sticker that has been attached to the floor. Before inserting the cable, check to make sure that the F03-25 is securely attached.

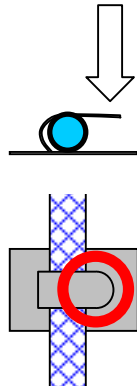

When inserting the cable, press the part of the F03-25 Sensing Band Sticker hook that is circled in red to bend it down. Do not apply too much force, or it may damage the F03-25 or the cable.

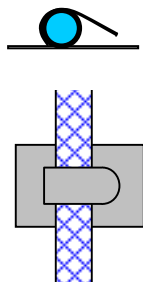

As shown in the figure to the left, secure the cable by pressing down the F03-25 Sensing Band Sticker hook until the cable cannot come loose.

2.4 Cable Connection Example

Connection Example 1: Confirming the Location of a Leak with the Leak Position

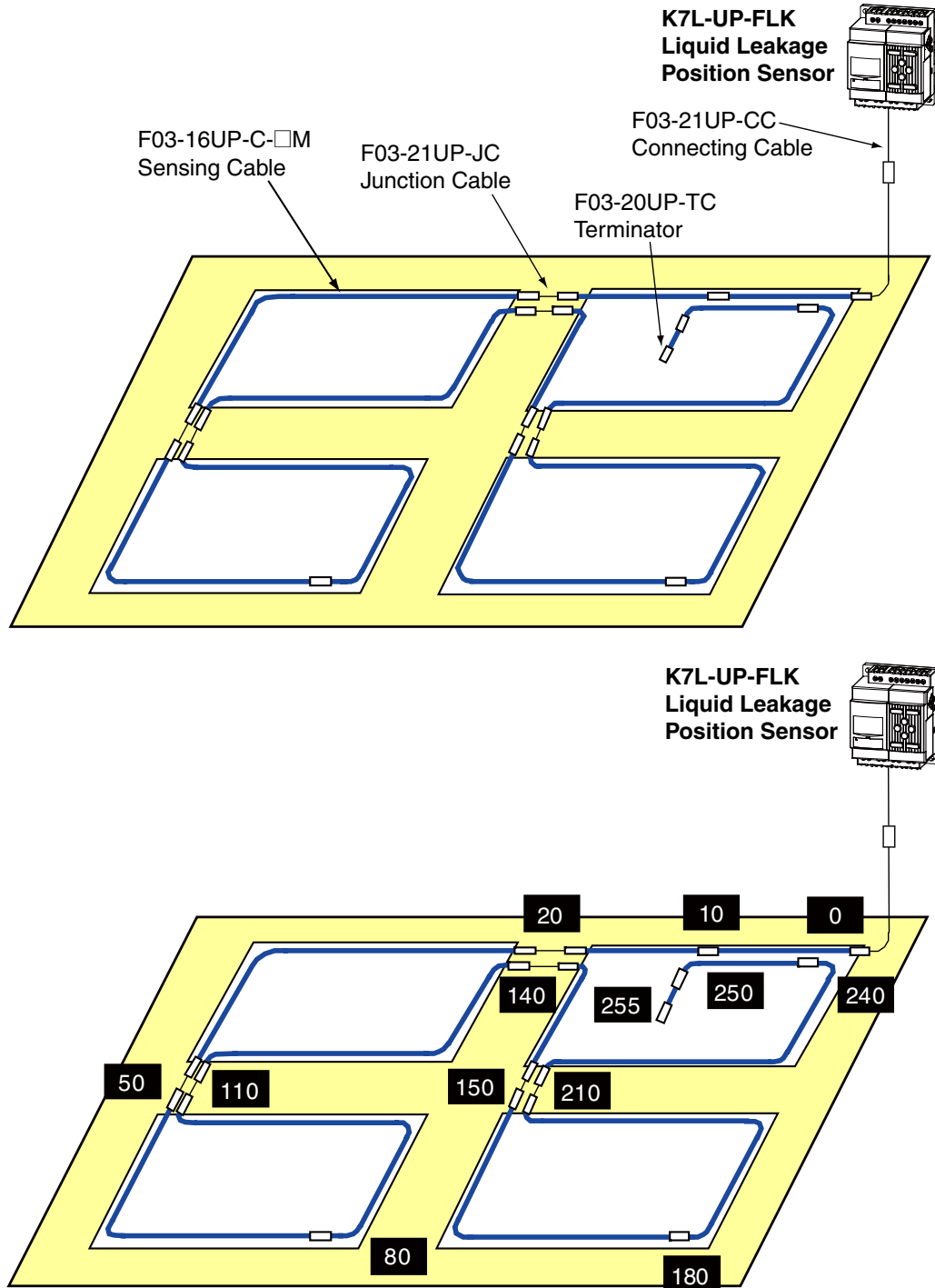

*The white numbers in boxes are the wiring lengths of Sensing Cable.

- Note: 1. When there is a long distance from the K7L-UP-FLK to the Sensing Cable, the displayed cable length may include that distance. If so, use the zero shift setting to adjust for the extra distance. For details on the zero shift setting, refer to 4.6 *Enabling the Zero Shift*.
2. When the Junction Cables are long, the displayed cable length may include that distance. It is recommended that you use the area settings to check for error caused by Junction Cables and correct the settings in advance. For details on the area settings, refer to 4.10 *Setting Detection Areas*.

Connection Example 2: Confirming the Location of a Leak Using Detection Areas

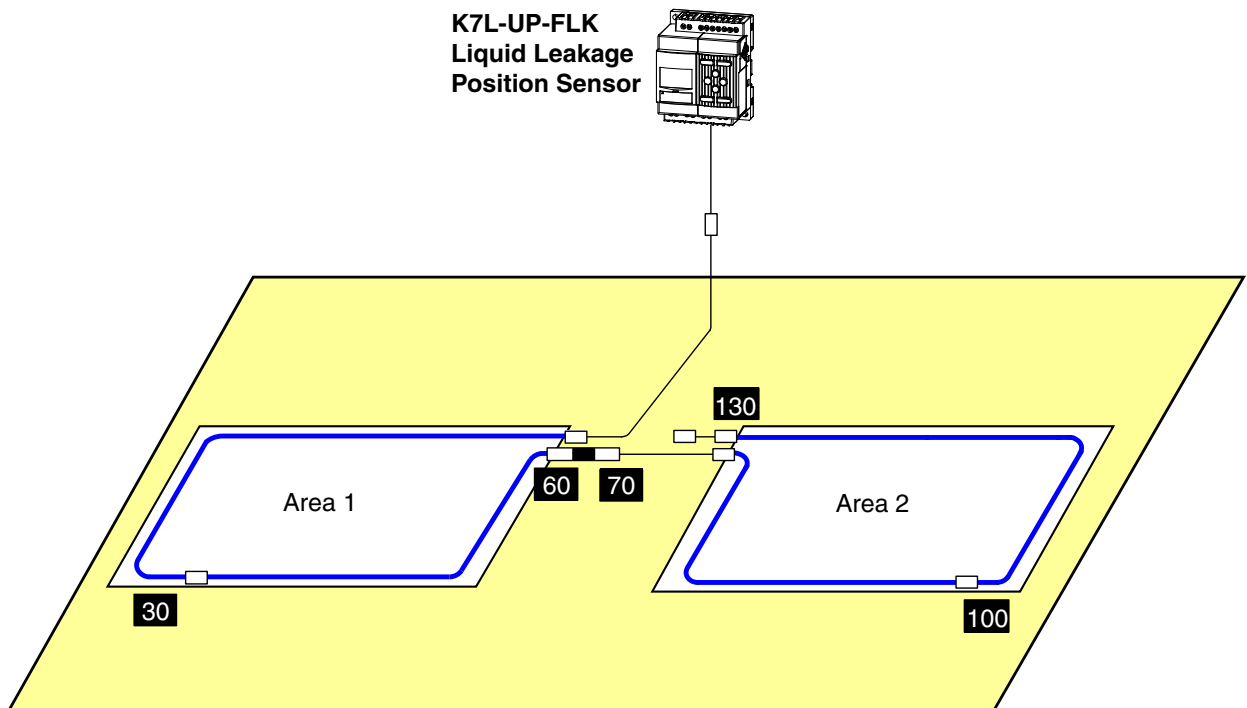
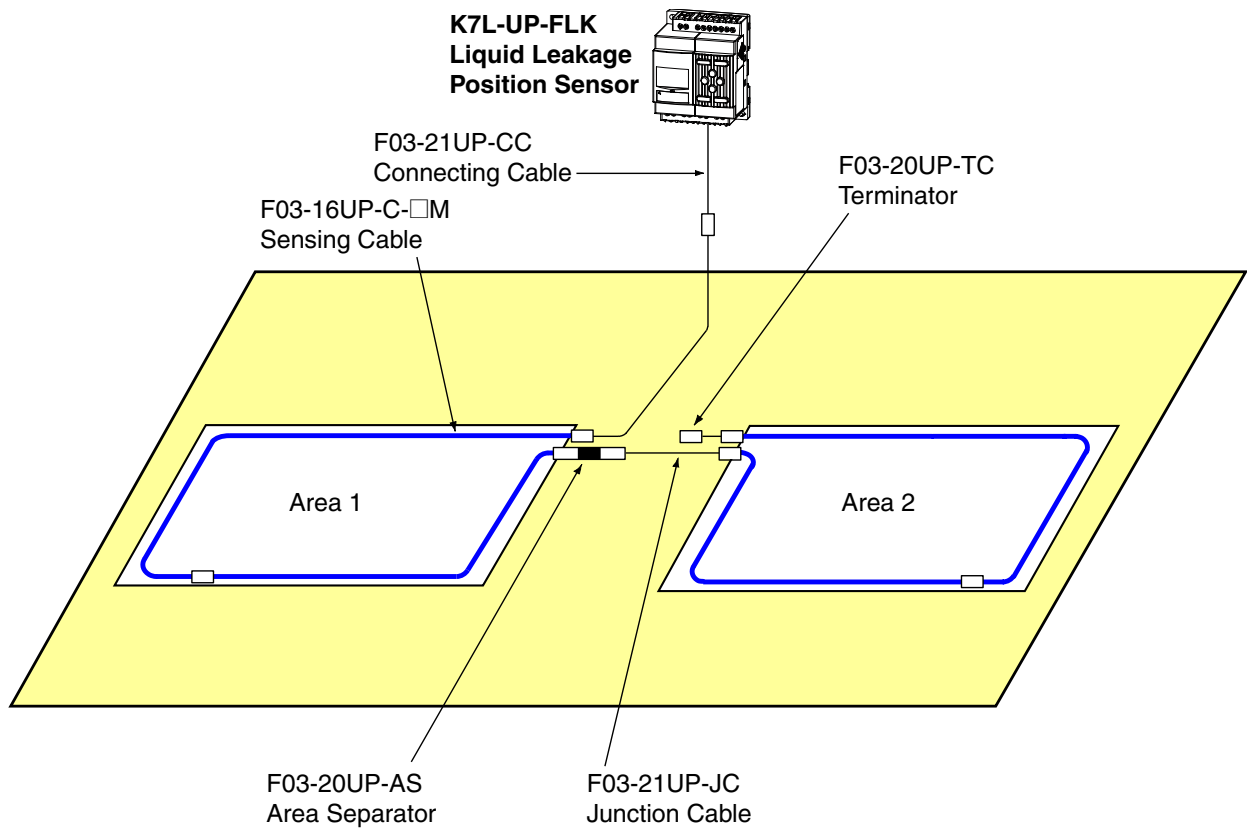

*The white numbers in boxes are the wiring lengths of Sensing Cable.

*The distance displayed for each Area Separator is equivalent to 10 m of Sensing Cable.

Note: 1. When there is a long distance from the K7L-UP-FLK to the Sensing Cable, the displayed cable length may include that distance. If so, use the zero shift setting to adjust for the extra distance. For details on the zero shift setting, refer to 4.6 *Enabling the Zero Shift*.

2. Refer to 4.11 *Editing Detection Areas* for the procedure to set areas when using Area Separators.



Section 3

Basic Procedure

3.1	Basic Setup.....	3-2
3.2	Overview of Operation.....	3-8
3.3	Procedures When Problems Are Detected	3-10
3.4	Operation Timecharts.....	3-13

3.1 Basic Setup

This section describes the basic setup procedures that are required after purchasing the K7L-UP-FLK Liquid Leakage Position Sensor. Before performing these procedures, make sure that all the wiring has been completed.

Note: If Connecting Cables, Sensing Cables, or a Terminator is not connected, a disconnection will be detected. Wire the Sensor correctly.



When the Sensor power is turned ON, the Starting Display will appear.

When processing has been finished (after approximately 30 s), the Monitor Display will appear.

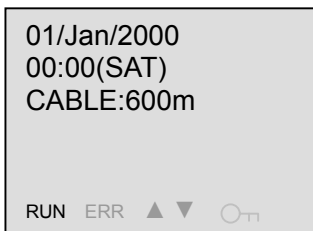

The following settings are required after purchase: contrast, language, time, and sensitivity.

First set the contrast.

1. Contrast Adjustment

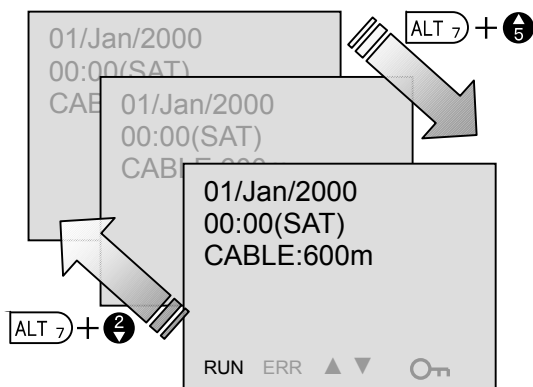

In the Monitor Display, adjust the contrast by simultaneously pressing the **ALT** Button and the **UP** or **DOWN** Button.

Increase the liquid crystal contrast by pressing the **ALT** and **UP** Buttons, or decrease the contrast by pressing the **ALT** and **DOWN** Buttons

The contrast can be set to any of six levels. Set the contrast to where it is easiest to read the display.

Note: If the contrast is set lower than necessary, it may be hard to see the display.

After the contrast has been set, press the **OK** Button for 3 s to change to Monitor Mode.

2. Setting the Language

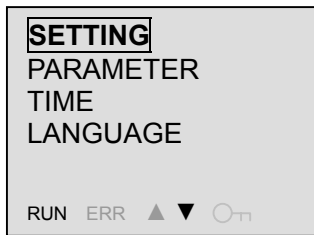

After entering Monitor Mode, move to Setting Mode by pressing the **OK** Button once when **SETTING** is selected.

Note: In the illustration on the left, the selected item is shown enclosed in a box. On the actual display the selected item will flash.



When moving to Setting Mode the selected item will change from **SETTING** to **RUN**, and the **RUN** indicator at the bottom left of the display will turn OFF.



Press the **DOWN** Button three times to select **LANGUAGE**, and then press the **OK** Button.



When **LANGUAGE** is entered, the display will change to enable checking the current setting. Press the **OK** Button again to enable changing the setting.

Note: The cursor flashing at **ENGLISH** indicates that the current setting is being displayed. The setting cannot be changed in this state.



The language will flash when the language setting can be changed. Press the **UP** or **DOWN** Button to change to Japanese.

After the setting has been made, press the **OK** Button.

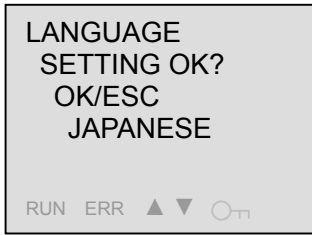

A display will ask for confirmation that the new setting is to be entered. To enter the new setting, press the **OK** Button.



After the setting has been entered, the display will switch back to the confirmation display. Press the **ESC** Button to return to Setting Mode.

3. Setting the Time



After returning to Setting Mode, press the **UP** Button once to select **TIME**. Then press the **OK** Button.



When **TIME** is entered, the display will change to a confirmation display. Press the **OK** Button again to enable editing the settings.

Note: The cursor flashing at the ones digit of the date indicates that the current setting is being displayed. The setting cannot be changed in this state.



The ones digit of the item that can be changed will flash when the setting can be changed.

Use the **LEFT** and **RIGHT** Buttons to switch between year, month, day, hour, and minutes.

Press the **UP** and **DOWN** Buttons to change the numbers.

Note: 1. The setting for the day of the week is changed automatically according to the date setting.

2. The year can be set from 00 to 99.



After the setting has been made, press the **OK** Button.

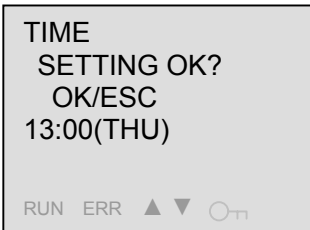

A display will ask for confirmation that the new setting is to be entered. To enter the new setting, press the **OK** Button.

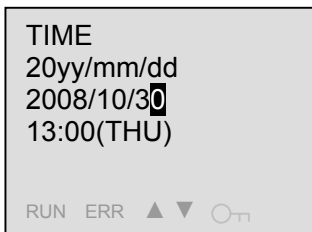

After the setting has been entered, the display will switch back to the confirmation display. Press the **ESC** Button to return to Setting Mode.

4. Setting the Sensitivity



After returning to Setting Mode, press the **DOWN** Button twice to select **INPUT**. Then press the **OK** Button.



When **INPUT** is entered, the Input Setting Display will appear. Select **SENS** and press the **OK** Button.

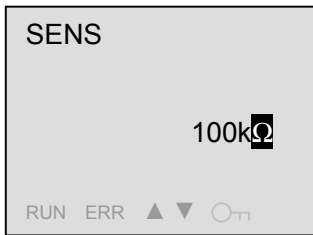

When **SENS** is entered, the display will change to a confirmation display. Press the **OK** Button again to enable changing the setting.

Note: The cursor flashing at 100 kΩ indicates that the current setting is being displayed. The setting cannot be changed in this state.

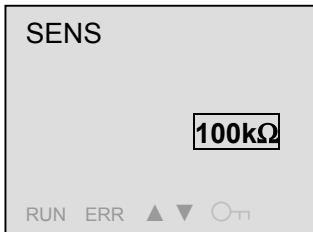

The sensitivity will flash when the setting can be changed.

Use the **UP** and **DOWN** Buttons to change the setting to 50 or 100 kΩ.

After the setting has been made, press the **OK** Button.

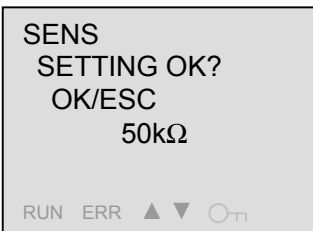

A display will ask for confirmation that the new setting is to be entered. To enter the new setting, press the **OK** Button.

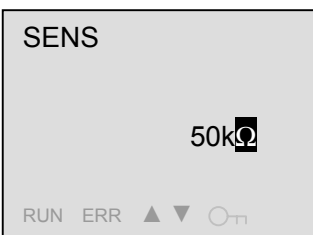

After the setting has been entered, the display will switch back to the confirmation display. Press the **ESC** Button to return to the Input Setting Display.



Press the **ESC** Button again to return to Setting Mode.

5. Returning to the Monitor Display



After returning to Setting Mode, press the **UP** Button four times to select **RUN**. Then press the **OK** Button to go to Monitor Mode.



When moving to Monitor Mode, the selected item will be changed from **RUN** to **SETTING**, and the **RUN** indicator at the bottom left of the display will light.

Press the **ESC** Button to return to the Monitor Display.



The above procedures make the basic settings.

For information on detailed settings, refer to *Section 4 Functions and Procedures*.

3.2 Overview of Operation

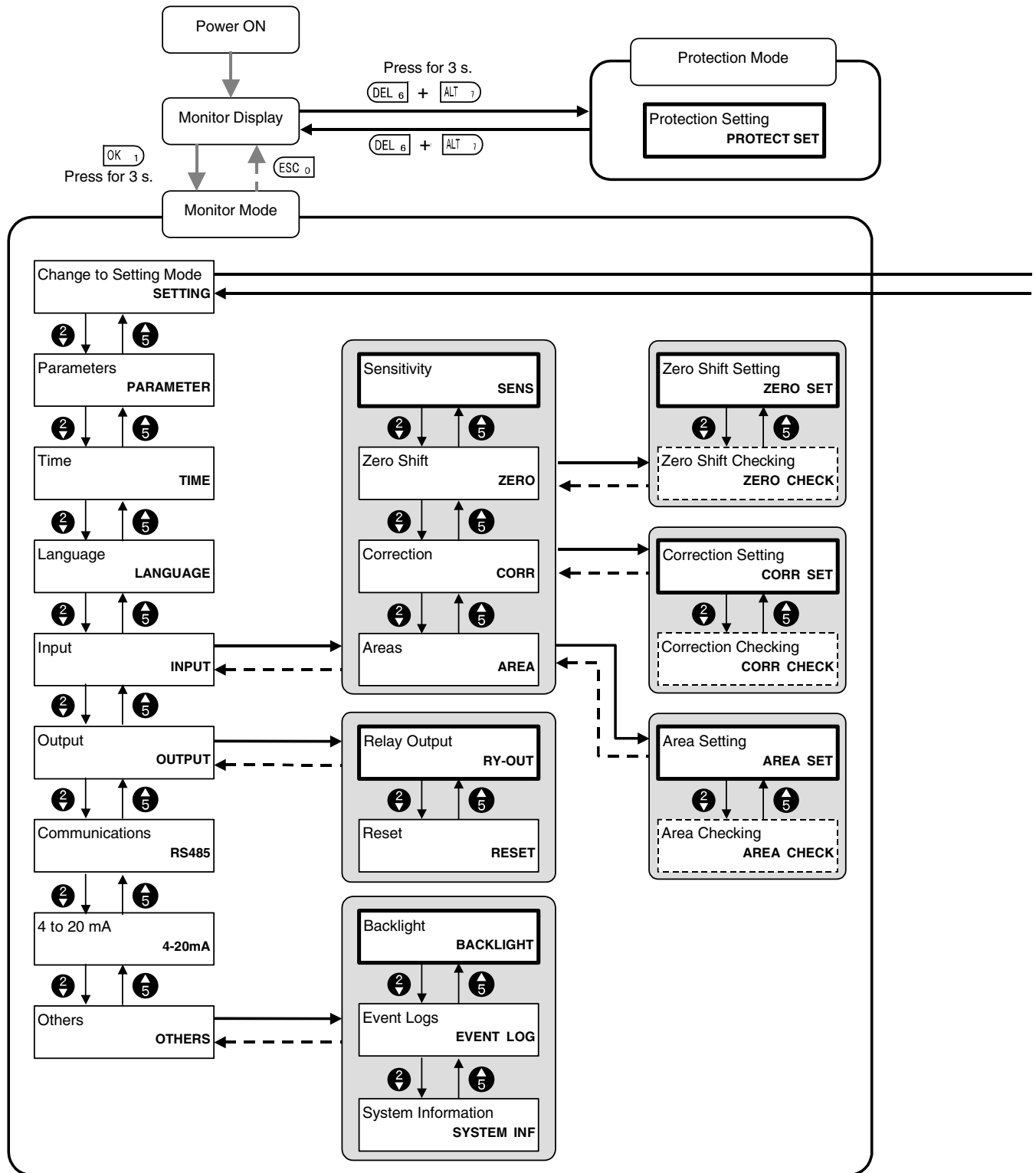

Note: 1. Settings cannot be changed in Monitor Mode.

2. The above diagram shows the configuration of the settings. For details, refer to Section 4 Functions and Procedures.

Note: The following arrows indicate the movement when the **OK** and **ESC** Buttons are pressed.

→ : **OK** pressed

- - - - - : **ESC** pressed

Note: **[Solid Box]** indicates the first item selected when entering that setting group.

Note: **[Dashed Box]** indicates items displayed when related settings are enabled.

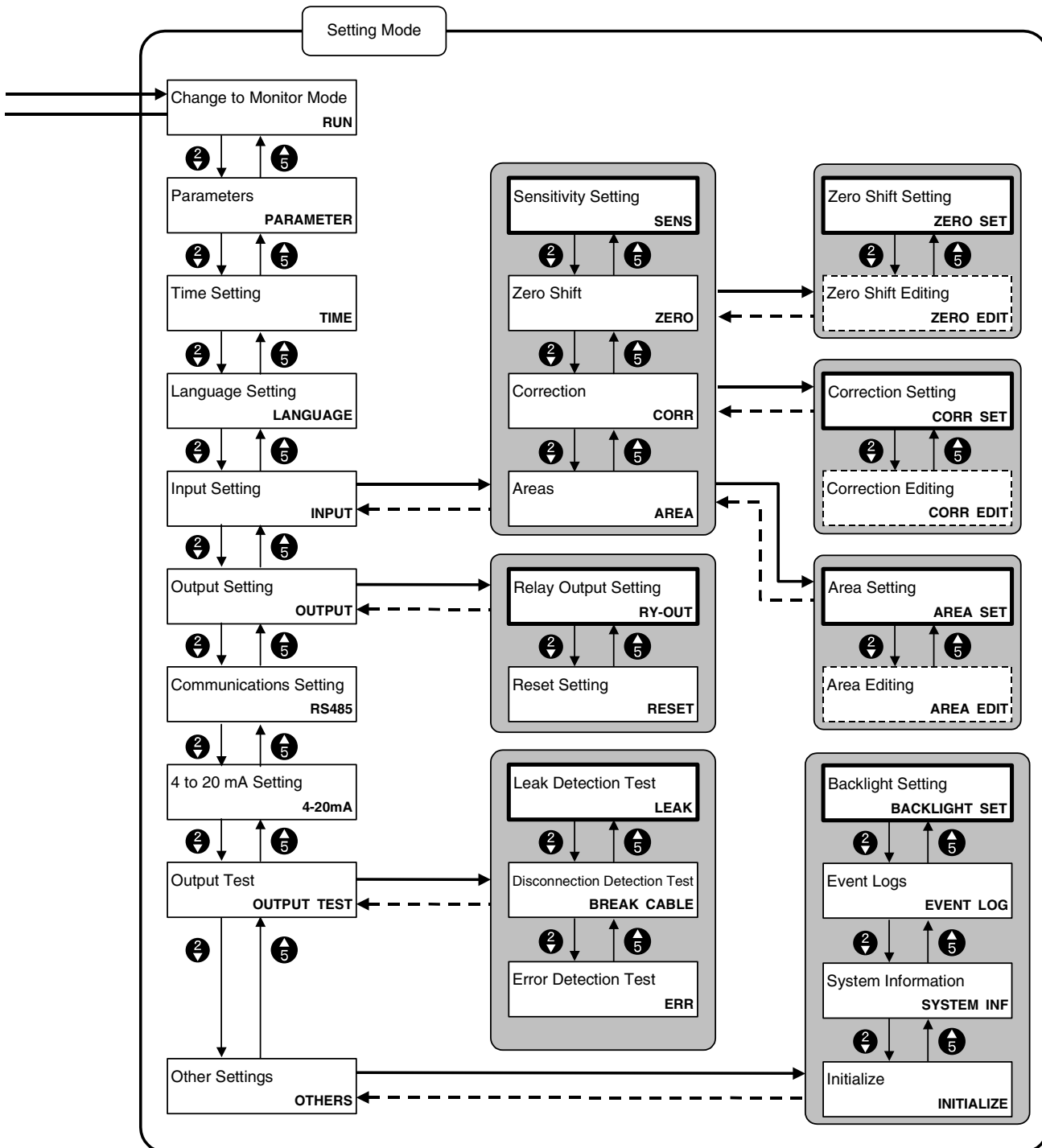

Note: If no key operations are performed and there are no communications for 30 minutes in Setting Mode, the Sensor will automatically return to Monitor Mode. Any settings that have not been completed will be lost.

3.3 Procedures When Problems Are Detected

This section describes the procedures and displays when a leak, disconnection, or error is detected.

Note: The reset procedure depends on the reset setting. For details, refer to 4.14 *Setting the Output Reset Method* and 3.4 *Operation Timecharts*.

1. When a Leak Is Detected

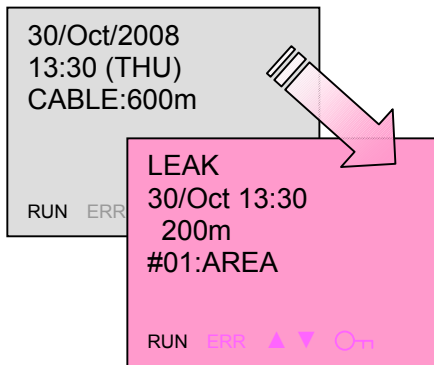

When a leak occurs, the display will switch from the Monitor Display to the Leak Display and the LCD backlight will turn red.

If the area settings have been made in advance, the area name will also be displayed according to the distance of the detected leak.

The leakage/disconnection output, the alarm output, and the linear output corresponding to the leakage detection distance (6 to 18 mA) are all output at this time.

2. When Leak Spreading Is Detected

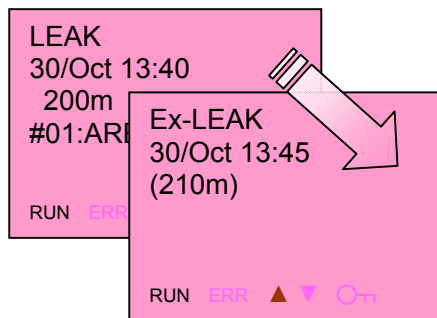

If a leak that has been detected spreads from the position of the original leak, the display will switch to the Ex-Leak Display.

It is possible to toggle between the Leak Display and the Ex-Leak Display by pressing the **UP** and **DOWN** Buttons.

The approximate measured leakage detection distance is displayed in parentheses on the Ex-Leak Display to given an indication of changes in the leak.

Note: Conditions for Detecting Leak Spreading and Distance Displays (Reference Values)

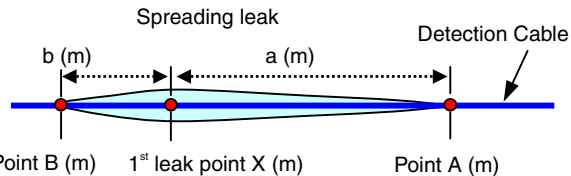
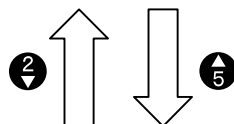

In the above example, a leak is spreading distance a (m) to point A (m) and distance b (m) from point B (m) from the first leak point X (m). Here, A is less than B.

If the leak spread detection distance is Y and $Y = a - b$, then leak spreading is detected if $Y \leq -10$ or $Y \geq 10$ m. The detection distance displayed in the parentheses on the display will be $X + Y$.

The display at the left is for the above diagram, where $X = 200$ m, $a = 15$ m, and $b = 5$ m.

Note: Spreading of a leak will not be detected if the leak spreads evenly from the point where the liquid first came into contact with the Detection Cable.

3. When a Second Leak Is Detected

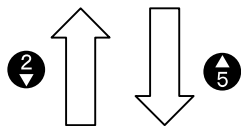
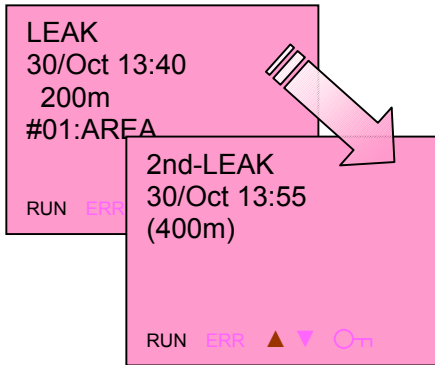

If a leak occurs in a second position while an initial leak is still being detected, the display will switch to the Second Leak Display.

It is possible to toggle between the Leak Display and the Second Leak Display by pressing the **UP** and **DOWN** Buttons.

The approximate measured leakage detection distance is displayed in parentheses on the Second Leak Display as a guide to the location of the second leak.

If the first leak position is cleaned up and dried in this state, and the leak status is cleared, the currently measured detection distance in the parentheses will change to the distance of the second leak.

This identifies the distance of the second leak.

Note: Conditions for Detecting a Second Leak and Distance Displays (Reference Values)

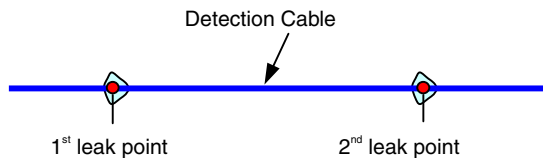

The above example is for standard city water. A second leak will be detected for the following conditions:

$$Y - X < -30 \text{ to } -20 \text{ m}$$

$$Y - X > 20 \text{ to } 30 \text{ m}$$

The detection distance displayed in the parentheses on the display will be approximately Y.

The display at the left is for the above diagram, where a second leak was found for X = 200 m and Y = approximately 400 m.

Even if the above conditions are met, the second leak may be detected as leak spreading for the first leak or it may not be detected at all if the leak resistances for the first and second leak are not the same.

Note: A second leak may be detected as spreading of the first leak if the resistances of the liquids at the first and second leaks are not the same. Also, after leak spreading has been detected, it is not possible to detect a second leak.

4. When a Disconnection Is Detected

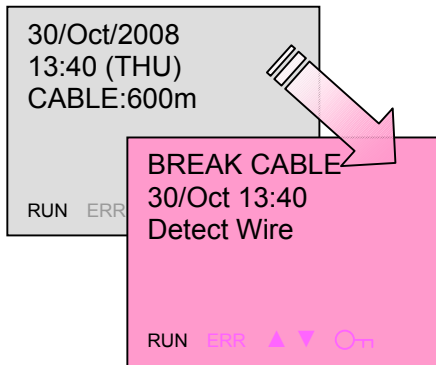

If a cable disconnection occurs, the display will switch from the Monitor Display to the Disconnection Display (BREAK CABLE) and the LCD backlight will flash red.

The wire that is broken in the cable will be displayed below the time and date: Detect Wire, Resist Wire, or Signal Wire.

Note: If two or more wires are broken, "Resist Wire" will appear.

The leakage/disconnection output, the alarm output, and the linear output (20 mA) are all output at this time.

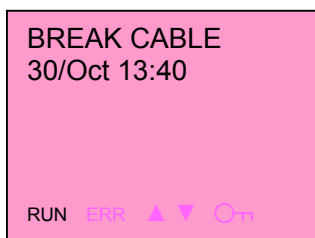

After the disconnection is fixed, the wire in the cable displayed below the time and date is no longer shown.

5. When an Error Is Detected

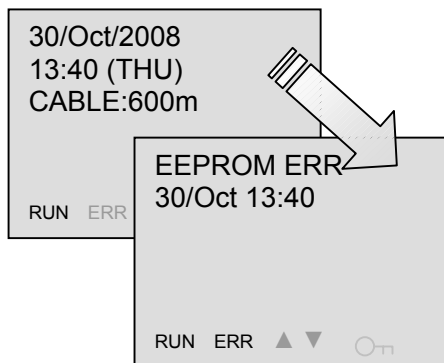

If an error is detected, the display will switch from the Monitor Display to the Error Display and the LCD backlight will flash green.

The contents of the error and the time that the error occurred will be displayed on the Error Display.

Note: For an RTC error, 0 will be displayed as the time that the error occurred.

The alarm output and the linear output (5 mA) are output at this time.

Details on error contents and countermeasures are given in the following table.

Error display	Error	Countermeasures
EEPROM ERR	An internal EEPROM (nonvolatile memory) error has occurred.	Turn ON the power again. If the error still occurs, there may be hardware damage. Contact your OMRON representative.
CABLE ERR	The Sensing Cable is longer than 699 m.	Check the wiring. CABLE ERR will continue to be displayed on the Monitor Display as long as the wiring is not corrected.
RTC ERR	An internal RTC (real-time clock) error has occurred.	Turn ON the power again. If the time cannot be set after the power is turned ON again, there may be hardware damage. Contact your OMRON representative.

3.4 Operation Timecharts

■ Automatic Reset

After a leak or disconnection occurs, the alarm output and leakage/disconnection output are automatically reset when the problem is corrected.

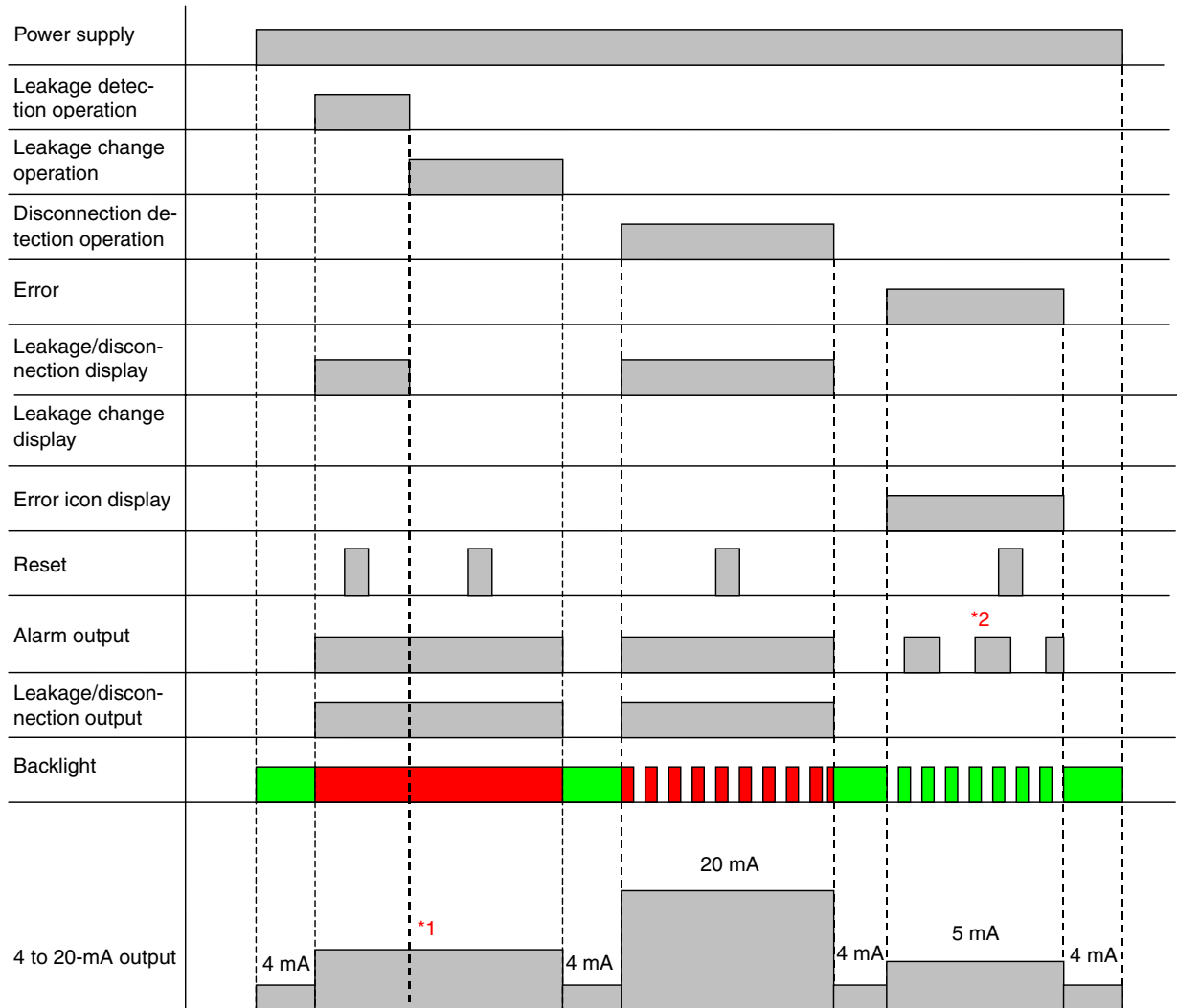

*1: Output = $6 + 12 \times \text{First leak distance (m)} / \text{Set value (m)}$ mA

*2: ON and OFF are repeated for 30 s each.

Manual Reset 1

The alarm output can be stopped by performing the reset procedure during a leak or disconnection. (The leakage/disconnection output continues.) The leakage/disconnection output is reset when the problem is corrected.

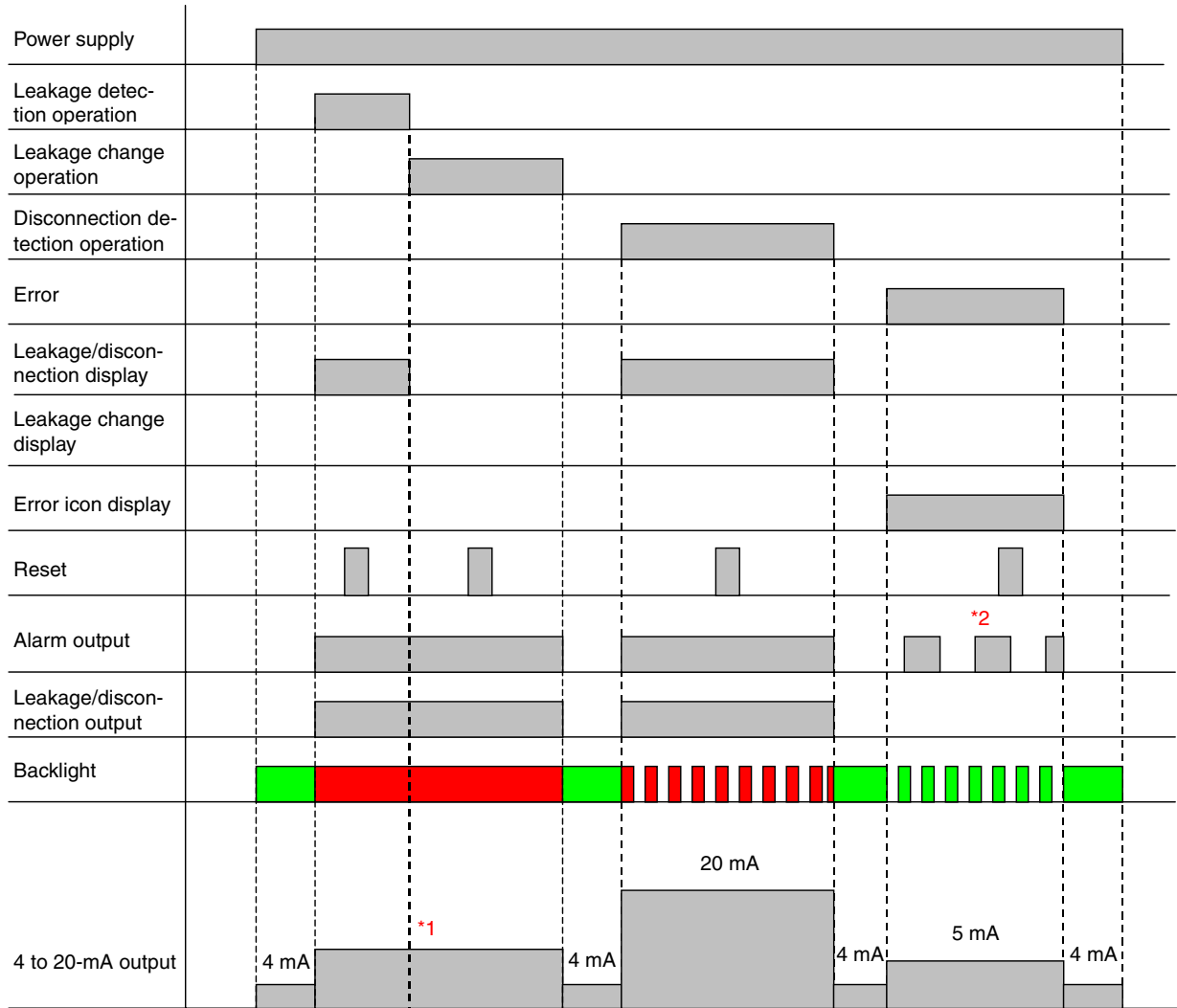

*1: Output = $6 + 12 \times \text{First leak distance (m)} / \text{Set value (m)}$ mA

*2: ON and OFF are repeated for 30 s each.

Manual Reset 2

The output is not automatically reset when the leak or disconnection is corrected. It is reset by performing the reset procedure after the leak or disconnection has been corrected.

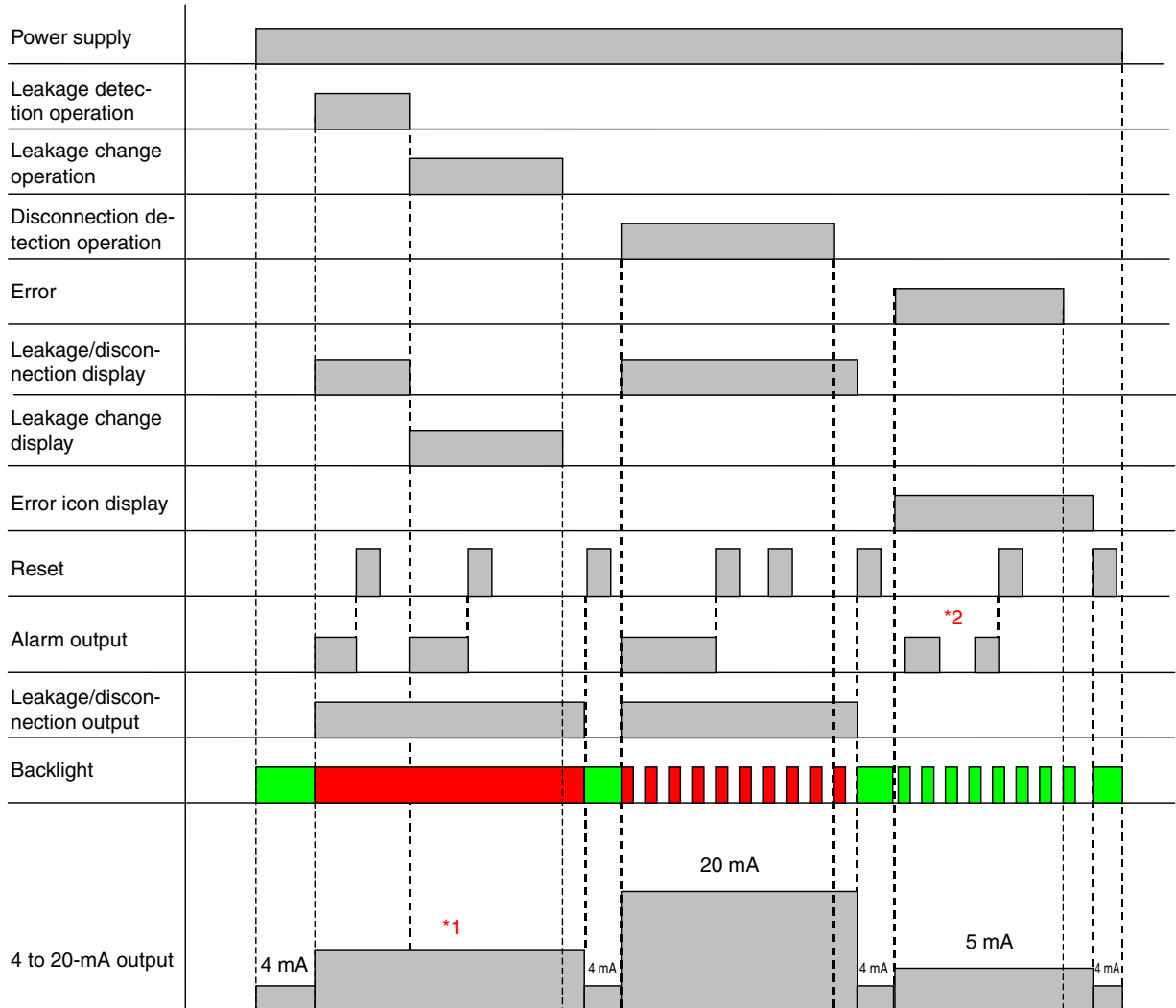

*1: Output = $6 + 12 \times \text{First leak distance (m) / Set value (m)}$ mA

*2: ON and OFF are repeated for 30 s each.

Section 4 Functions and Procedures

This section describes the functions of the Sensor and the operating procedures.

4.1	Setup Procedures.....	4-2
4.2	Checking Parameters.....	4-6
4.3	Setting the Date and Time.....	4-7
4.4	Setting the Language.....	4-9
4.5	Setting the Detection Sensitivity.....	4-11
4.6	Enabling the Zero Shift.....	4-13
4.7	Setting the Zero Shift.....	4-15
4.8	Enabling the Correction.....	4-17
4.9	Setting the Correction.....	4-19
4.10	Setting Detection Areas.....	4-21
4.11	Editing Detection Areas.....	4-23
4.12	Deleting Detection Areas.....	4-30
4.13	Setting the Relay Output Method.....	4-32
4.14	Setting the Output Reset Method.....	4-34
4.15	Setting Communications.....	4-36
4.16	Setting the Linear Output (4 to 20 mA).....	4-38
4.17	Output Test Method for the Leak Detection Test.....	4-40
4.18	Output Test Method for the Disconnection Detection Test.....	4-42
4.19	Output Test Method for the Error Detection Test.....	4-44
4.20	Setting the Backlight ON Time.....	4-45
4.21	Checking the Event Logs.....	4-47
4.22	Checking System Information.....	4-49
4.23	Initialization Method.....	4-50
4.24	Short-circuiting a Sensing Cable.....	4-52
4.25	Copy Function when Setting Distances.....	4-53
4.26	Setting Protection.....	4-55

4.1 Setup Procedures

■ Entering Setting Mode

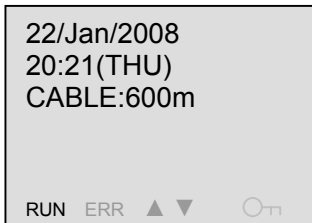

Press the **OK** Button for 3 s during monitoring to enter Monitor Mode.

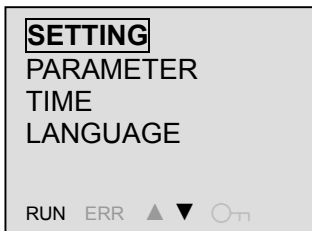

When the mode changes to Monitor Mode, the display will change to the one shown to the left. Press the **OK** Button while **SETTING** is flashing to enter Setting Mode.

Note: In the illustration to the left, the selected item is shown enclosed in a box. In the actual display, the selected item will flash.



When the mode changes to Setting Mode, the selected item will change from **SETTING** to **RUN**. This indicates that the mode is now Setting Mode.

Note: When the mode changes from Monitor Mode to Setting Mode, the **RUN** indicator at the bottom left of the display will turn OFF.

Use the **UP** and **DOWN** Buttons to select an item, and then press the **OK** Button to enter the selection. The settings for the selected item can then be checked and edited.

Note: If no key operations are performed and there are no communications for 30 minutes in Setting Mode, the Sensor will automatically return to Monitor Mode. Any settings that have not been completed will be lost.

■ Returning to Monitor Mode



Use the **UP** and **DOWN** Buttons to select **RUN**.

Note: In the illustration to the left, the selected item is shown enclosed in a box. In the actual display, the selected item will flash.



Press the **OK** Button to switch to Monitor Mode.









Note: When the mode changes from Setting Mode to Monitor Mode, the **RUN** indicator at the bottom left of the display will light.











Press the **ESC** Button while in Monitor Mode to return to the Monitor Display.

Note: It is not possible to return to the Monitor Display directly from Setting Mode.

■ Button Functions in Setting Mode and When Editing Settings

Button	Name	Function	
		Monitor Display	Monitor Mode
	DEL Button	- Use in combination with the ALT Button to go into Protection Mode. (Press for 3 s.)	-
	ALT Button	Not used by itself.	-
	UP Button	- In combination with the ALT Button, increases the contrast.	Moves the cursor up.
	DOWN Button	- In combination with the ALT Button, reduces the contrast.	Moves the cursor down.
	LEFT Button	-	-
	RIGHT Button	-	-
	ESC Button	- In combination with the ALT Button, resets the outputs.	Returns to the previous display. Returns to the Monitor Display.
	OK Button	Press for 3 s to go into Monitor Mode.	Enters the selected item.

■ Button Functions in Setting Mode and When Editing Settings (Continued)

Button	Name	Function	
		Setting Mode	When Editing Settings
	DEL Button	-	Deletes a character. Deletes an area.
	ALT Button	-	Not used by itself.
	UP Button	Moves the cursor up.	Changes the selected item, number, or characters in forward order. Examples: Numbers: 1→2→3→●●● Characters: A→B→C→●●● In combination with the ALT Button, changes the character type in order. Example: A→a→ア→●●● (See note.)
	DOWN Button	Moves the cursor down.	Changes the selected item, number, or character in reverse order. Examples: Numbers: 3→2→1→●●● Characters: C→B→A→●●● In combination with the ALT Button, changes the character type in reverse order. Example: ア→a→A→●●● (See note.)
	LEFT Button	-	Moves the selected place to the left. Copies, in combination with the RIGHT Button. (Press for 3 s.)
	RIGHT Button	-	Moves the selected place to the right. In combination with the LEFT Button, copies the selected item. (Press for 3 s.)
	ESC Button	Returns to the previous display.	Discards the setting and returns to the previous step. In combination with the ALT Button, resets the outputs.
	OK Button	Executes the selected item.	Enters the edited item.

Note: Japanese kana characters cannot be set if English is selected as the language.

4.2 Checking Parameters

This section describes how to check the current parameter settings.

The following parameters can be checked: Cable length, sensitivity, number of areas, zero shift setting, correction setting, relay output, 4 to 20 mA, and node number.



Enter Setting Mode, use the **UP** and **DOWN** Buttons to select **PARAMETER**, and press the **OK** Button.

Note: 1. For details on how to enter Setting Mode from Monitor Mode, refer to *Setup Procedures* on page 4-2.

2. In the illustration to the left, the selected item is shown enclosed in a box. In the actual display, the selected item will flash.

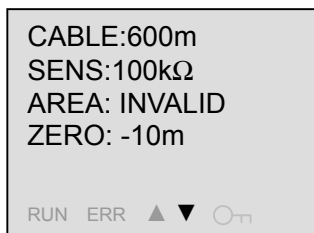

When **PARAMETER** is entered, the display will change to the one shown on the left. The settings can be checked by using the **UP** and **DOWN** Buttons to scroll up and down the display.

Note: The ▲ and ▼ symbols at the bottom of the display indicate that cursor movement or scrolling is enabled in that direction.



After the settings have all been checked, press the **ESC** Button to end checking the parameter.

4.3 Setting the Date and Time

This section describes how to set the date and the time.



Enter Setting Mode, use the **UP** and **DOWN** Buttons to select **TIME**, and press the **OK** Button.

Note: 1. For details on how to enter Setting Mode from Monitor Mode, refer to *Setup Procedures* on page 4-2.

2. In the illustration to the left, the selected item is shown enclosed in a box. In the actual display, the selected item will flash.

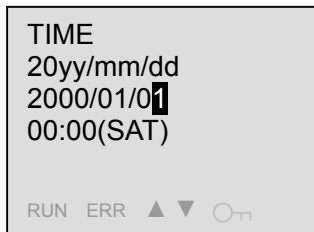

When **TIME** is entered, the display will change to a confirmation display. Press the **OK** Button again to enable editing the settings.

Note: The cursor flashing at the ones digit of the date indicates that the current setting is being displayed. The setting cannot be changed in this state.



The ones digit of the item that can be changed will flash when the setting can be changed.

Use the **LEFT** and **RIGHT** Buttons to switch between year, month, day, hour, and minute. Then press the **UP** and **DOWN** Buttons to change the numbers.

Note: 1. The setting for the day of the week is changed automatically according to the date setting.

2. The year can be set from 00 to 99.



After the setting has been made, press the **OK** Button.

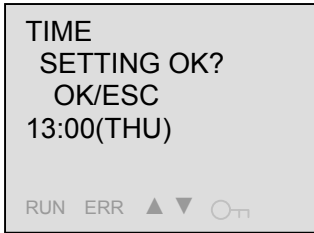

A display will ask for confirmation that the new setting is to be entered. To enter the new setting, press the **OK** Button.

To change the setting before entering it, press the **ESC** Button to return to the previous display.

Note: To abort the setting procedure, press the **ESC** Button until Setting Mode display returns. You will have to press the **ESC** Key several times.



After the setting has been entered, the display will switch back to the confirmation display. Press the **ESC** Button to return to Setting Mode.

4.4 Setting the Language

This section describes how to set the language that is used on the display.

Note: The default language setting is **ENGLISH**, so English will be used after purchase and after initialization.



Enter Setting Mode, use the **UP** and **DOWN** Buttons to select **LANGUAGE**, and press the **OK** Button.

Note: 1. For details on how to enter Setting Mode from Monitor Mode, refer to *Setup Procedures* on page 4-2.

2. In the illustration to the left, the selected item is shown enclosed in a box. In the actual display, the selected item will flash.



When **LANGUAGE** is entered, the display will change to enable checking the current setting. Press the **OK** Button again to enable changing the setting.

Note: The display on the left indicates that the current setting is **JAPANESE**. The setting cannot be changed in this state.



The language will flash when the setting can be changed. Use the **UP** or **DOWN** Button to change to the desired language, either **ENGLISH** or **JAPANESE**.

Note: Be careful when changing the language. All items will be changed to whichever language is set.



After the setting has been made, press the **OK** Button.

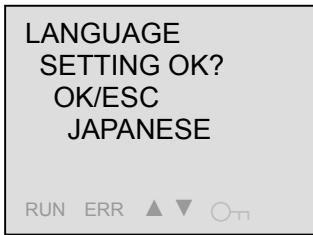

A display will ask for confirmation that the new setting is to be entered. To enter the new setting, press the **OK** Button.

To change the setting before entering it, press the **ESC** Button to return to the previous display.

Note: To abort the setting procedure, press the **ESC** Button until Setting Mode display returns. You will have to press the **ESC** Key several times.



After the setting has been entered, the display will switch back to the confirmation display. Press the **ESC** Button to return to Setting Mode.

4.5 Setting the Detection Sensitivity

This section describes how to set the input detection sensitivity.



Enter Setting Mode, use the **UP** and **DOWN** Buttons to select **INPUT**, and press the **OK** Button.

Note: 1. For details on how to enter Setting Mode from Monitor Mode, refer to *Setup Procedures* on page 4-2.

2. In the illustration to the left, the selected item is shown enclosed in a box. In the actual display, the selected item will flash.



When **INPUT** is entered, the display will change to the Input Setting Display. Use the **UP** and **DOWN** Buttons to select **SENS**, and press the **OK** Button.

Note: To abort the setting procedure, press the **ESC** Button until Setting Mode display returns. You will have to press the **ESC** Key several times.

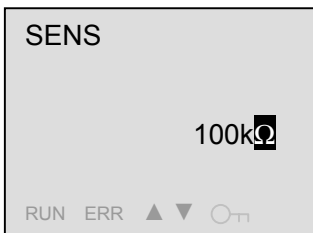

When **SENS** is entered, the display will change to a confirmation display. Press the **OK** Button again to enable changing the setting.

Note: The display on the left indicates that the current setting is 100 kΩ. The setting cannot be changed in this state.

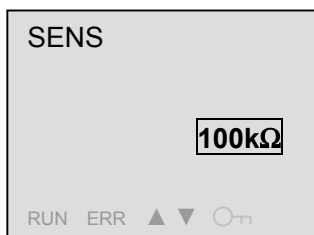

The sensitivity will flash when the setting can be changed. Use the **UP** and **DOWN** Buttons to set 50 or 100 kΩ.

After the setting has been made, press the **OK** Button.

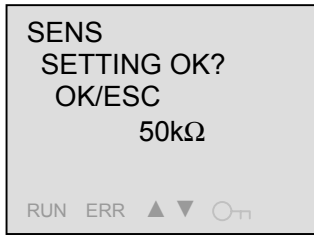

A display will ask for confirmation that the new setting is to be entered. To enter the new setting, press the **OK** Button.

To change the setting before entering it, press the **ESC** Button to return to the previous display.

Note: To abort the setting procedure, press the **ESC** Button until Setting Mode display returns. You will have to press the **ESC** Key several times.



After the setting has been entered, the display will switch back to the confirmation display. Press the **ESC** Button to return to **INPUT**.



Press the **ESC** Button again to return to Setting Mode.

4.6 Enabling the Zero Shift

This section describes how to enable the zero shift.

What Is the Zero Shift?

The zero shift changes the 0-m position of the Sensing Cable. When there is a distance between the K7L-UP-FLK and the place where leakage is to be detected, the display can be made easier to understand by changing a specified position to 0 m.



Enter **INPUT**, use the **UP** and **DOWN** Buttons to select **ZERO**, and press the **OK** Button.

- Note:
1. For details on how to enter Setting Mode from Monitor Mode, refer to *Setup Procedures* on page 4-2.
 2. For details on entering **INPUT** from Setting Mode, refer to *4.5 Setting the Detection Sensitivity*.
 3. In the illustration to the left, the selected item is shown enclosed in a box. In the actual display, the selected item will flash.



When **ZERO** is entered, the display will change to a selection display. Select **ZERO SET** and press the **OK** Button.

- Note: To abort the setting procedure, press the **ESC** Button until Setting Mode display returns. You will have to press the **ESC** Key several times.

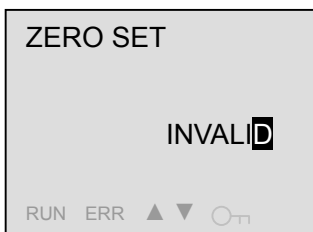

When **ZERO SET** is entered, the display will change to a confirmation display. Press the **OK** Button again to enable changing the setting.

- Note: The display on the left indicates that the current setting is **INVALID**, i.e., that this function is currently disabled. The setting cannot be changed in this state.



The setting will flash when it can be changed. Press the **UP** and **DOWN** Buttons to change the setting to **VALID** or **INVALID**.

After the change has been made, press the **OK** Button.

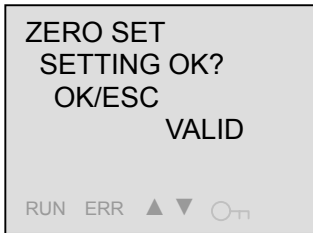

A display will ask for confirmation that the new setting is to be entered. To enter the new setting, press the **OK** Button.

To change the setting before entering it, press the **ESC** Button to return to the previous display.

Note: To abort the setting procedure, press the **ESC** Button until Setting Mode display returns. You will have to press the **ESC** Key several times.



After the setting has been entered, the display will switch back to the confirmation display. Press the **ESC** Button to return to **ZERO**.



Press the **ESC** Button to return to Setting Mode.

Note: **ZERO EDIT** can be displayed by selecting **VALID** for **ZERO SET**.

4.7 Setting the Zero Shift

This section describes how to set the zero shift.



Enter **INPUT**, use the **UP** and **DOWN** Buttons to select **ZERO**, and press the **OK** Button.

- Note:
1. For details on how to enter Setting Mode from Monitor Mode, refer to *Setup Procedures* on page 4-2.
 2. For details on entering **INPUT** from Setting Mode, refer to *4.5 Setting the Detection Sensitivity*.
 3. In the illustration to the left, the selected item is shown enclosed in a box. In the actual display, the selected item will flash.



When **ZERO** is entered, the display will change to a selection display. Use the **UP** and **DOWN** Buttons to select **ZERO EDIT**, and then press the **OK** Button.

- Note:
1. To abort the setting procedure, press the **ESC** Button until Setting Mode display returns. You will have to press the **ESC** Key several times.
 2. **ZERO EDIT** will not be displayed unless **VALID** is selected for **ZERO SET**.



When **ZERO EDIT** is entered, the display will change to the Zero Shift Confirmation Display. Press the **OK** Button to enable setting the zero shift distance.

- Note: The display on the left indicates that the current setting is -000 m . The setting cannot be changed in this state.



Use the **LEFT** and **RIGHT** Buttons to select the digit of the zero shift distance that is to be changed.

Use the **UP** and **DOWN** Buttons with a digit selected to change the value.

SHORT 015m indicates the current short-circuit position.

- Note:
1. For details on short-circuiting cables, refer to *4.24 Short-circuiting a Sensing Cable*.
 2. A copy function for easily setting the zero shift position is supported. For details, refer to *4.25 Copy Function when Setting Distances*.



After the zero shift distance has been changed, press the **OK** Button.

Note: Shifting for -100 to 0 m is possible.

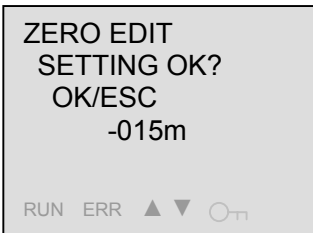

A display will ask for confirmation that the new setting is to be entered. To enter the new setting, press the **OK** Button.

To change the setting before entering it, press the **ESC** Button to return to the previous display.

Note: To abort the setting procedure, press the **ESC** Button until Setting Mode display returns. You will have to press the **ESC** Key several times.



After the setting has been entered, the display will switch back to the confirmation display. Press the **ESC** Button to return to **ZERO**.



Press the **ESC** Button to return to Setting Mode.

4.8 Enabling the Correction

This section describes how to enable corrections.

What Is a Correction?

The correction changes the length of the Sensing Cable to any value. If there is a discrepancy between the actual cable length and the measured cable length due to an error in measuring the K7L-UP-FLK cable length, the measured value can be corrected to any value.

Note: Set the zero shift before setting the correction. For details on entering the Zero Shift Display from Setting Mode, refer to *4.6 Enabling the Zero Shift*.



Enter **INPUT**, use the **UP** and **DOWN** Buttons to select **CORR**, and press the **OK** Button.

Note: 1. For details on how to enter Setting Mode from Monitor Mode, refer to *4.1 Setup Procedures*.

2. For details on entering **INPUT** from Setting Mode, refer to *4.5 Setting the Detection Sensitivity*.

3. In the illustration to the left, the selected item is shown enclosed in a box. In the actual display, the selected item will flash.



When **CORR** is entered, the display will change to a selection display. Select **CORR SET** and then press the **OK** Button.

Note: To abort the setting procedure, press the **ESC** Button until Setting Mode display returns. You will have to press the **ESC** Key several times.



When **CORR SET** is entered, the display will change to a confirmation display. Press the **OK** Button again to enable changing the setting.

Note: The display on the left indicates that the current setting is **INVALID**, i.e., that this function is currently disabled. The setting cannot be changed in this state.



The setting will flash when it can be changed. Press the **UP** and **DOWN** Buttons to set either **VALID** or **INVALID**. After the setting has been made, press the **OK** Button.

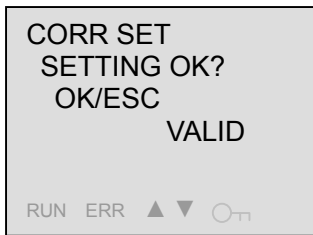

A display will ask for confirmation that the new setting is to be entered. To enter the new setting, press the **OK** Button.

To change the setting before entering it, press the **ESC** Button to return to the previous display.

Note: To abort the setting procedure, press the **ESC** Button until Setting Mode display returns. You will have to press the **ESC** Key several times.



After the setting has been entered, the display will switch back to the confirmation display. Press the **ESC** Button to return to **CORR**.



Press the **ESC** Button to return to Setting Mode.

Note: **CORR EDIT** will be displayed and can be selected by setting **VALID** for **CORR SET**.

4.9 Setting the Correction

This section describes how to set the correction value.



Enter **INPUT**, use the **UP** and **DOWN** Buttons to select **CORR**, and press the **OK** Button.

- Note:
1. For details on how to enter Setting Mode from Monitor Mode, refer to *4.1 Setup Procedures*.
 2. For details on entering **INPUT** from Setting Mode, refer to *4.5 Setting the Detection Sensitivity*.
 3. In the illustration to the left, the selected item is shown enclosed in a box. In the actual display, the selected item will flash.



When **CORR** is entered, the display will change to a selection display. Use the **UP** and **DOWN** Buttons to select **CORR EDIT**, and press the **OK** Button.

- Note:
1. To abort the setting procedure, press the **ESC** Button until Setting Mode display returns. You will have to press the **ESC** Key several times.
 2. **CORR EDIT** will not be displayed unless **VALID** is selected for **CORR SET**.



When **CORR SET** is entered, the display will change to the Correction Confirmation Display. Press the **OK** Button again to enable setting the correction distance.

- Note: The cursor flashing at one digit of +000m indicates the current setting. The setting cannot be changed in this state.



Use the **LEFT** and **RIGHT** Buttons to select the correction distance digit to be changed.

- Note: The selection of + or – can be made by pressing the **UP** or **DOWN** Button at the third digit.

With the digit to be changed selected, use the **UP** and **DOWN** Buttons to change the number.

- Note: The correction distance can be set from –100 to +100 m.

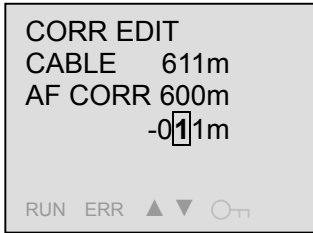

After the correction distance has been changed, press the **OK** Button.

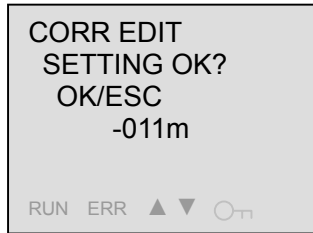

A display will ask for confirmation that the new setting is to be entered. To enter the new setting, press the **OK** Button.

To change the setting before entering it, press the **ESC** Button to return to the previous display.

Note: To abort the setting procedure, press the **ESC** Button until Setting Mode display returns. You will have to press the **ESC** Key several times.



After the setting has been entered, the display will switch back to the confirmation display. Press the **ESC** Button to return to the Correction Display.



Press the **ESC** Button several times to return to Setting Mode.

4.10 Setting Detection Areas

This section describes how to set input detection areas.

What Is a Detection Area?

The Sensing Cable can be divided into user-set ranges called areas, which you can name. Pre-setting detection areas makes it possible for area names to be displayed in the Detection Display to indicate where a leak is detected.

Note: Set the zero shift and correction value before setting the detection areas. For details on entering the Zero Shift Display from Setting Mode, refer to *4.6 Enabling the Zero Shift*. For details on entering **CORR** from Setting Mode, refer to *4.8 Enabling the Correction*.



Enter **INPUT**, use the **UP** and **DOWN** Buttons to select **AREA**, and press the **OK** Button.

- Note:
1. For details on how to enter Setting Mode from Monitor Mode, refer to *4.1 Setup Procedures*.
 2. For details on entering **INPUT** from Setting Mode, refer to *4.5 Setting the Detection Sensitivity*.
 3. In the illustration to the left, the selected item is shown enclosed in a box. In the actual display, the selected item will flash.



When **AREA** is entered, the display will change to a selection display. Select **AREA SET**, and then press the **OK** Button.

Note: To abort the setting procedure, press the **ESC** Button until Setting Mode display returns. You will have to press the **ESC** Key several times.



When **AREA SET** is entered, the display will change to a confirmation display. Press the **OK** Button again to enable changing the setting.

Note: The display on the left indicates that the current setting is **INVALID**, i.e., that this function is currently disabled. The setting cannot be changed in this state.



The setting will flash when it can be changed. Press the **UP** and **DOWN** Buttons to change the setting to **VALID** or **INVALID**.

After the change has been made, press the **OK** Button.

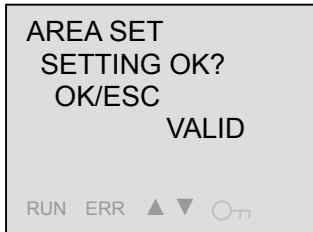

A display will ask for confirmation that the new setting is to be entered. To enter the new setting, press the **OK** Button.

To change the setting before entering it, press the **ESC** Button to return to the previous display.

Note: To abort the setting procedure, press the **ESC** Button until Setting Mode display returns. You will have to press the **ESC** Key several times.



After the setting has been entered, the display will switch back to the confirmation display. Press the **ESC** Button to return to **AREA**.



Press the **ESC** Button until you return to Setting Mode.

Note: **AREA EDIT** can be displayed by selecting **VALID** for **AREA SET**.

4.11 Editing Detection Areas

This section describes how to edit detection areas.

Note: Refer to *Editing Detection Areas When Using Sensing Cables and Area Sensors* later in this section for the procedure to set areas when using Area Separators.

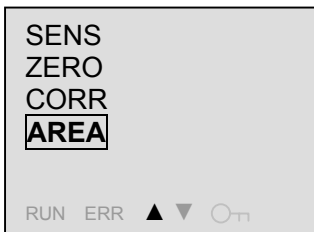

Enter **INPUT**, use the **UP** and **DOWN** Buttons to select **AREA**, and press the **OK** Button.

- Note: 1. For details on how to enter Setting Mode from Monitor Mode, refer to *4.1 Setup Procedures*.
2. For details on entering **INPUT** from Setting Mode, refer to *4.5 Setting the Detection Sensitivity*.
3. In the illustration to the left, the selected item is shown enclosed in a box. In the actual display, the selected item will flash.



When **AREA** is entered, the display will change to a selecting display. Again use the **UP** and **DOWN** Buttons to select **AREA EDIT**, and press the **OK** Button.

- Note: 1. To abort the setting procedure, press the **ESC** Button until Setting Mode display returns. You will have to press the **ESC** Key several times.
2. **AREA EDIT** will not be displayed unless **VALID** is selected for **AREA SET**.

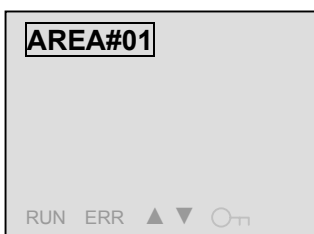

When **AREA SET** is entered, the display will change to the Area Selection Display. Press the **UP** and **DOWN** Buttons to select the area to be edited, and then press the **OK** Button.

Note: When editing for the first time, only area 1 will be displayed. Each time you set an area, it will enable the next area, i.e., area 2, area 3, etc.



The display will change to the Area Confirmation Display. Press the **OK** Button again.

Note: The display on the left indicates that the current **AREA#01** setting distance is 000 to 699 m, and that the area name is **AREA**. The setting cannot be changed in this state.



With **AREA#01** selected (i.e., with the “1” flashing), press the **RIGHT** Button.

Note: Press the **UP** or **DOWN** Buttons while in the state shown to the left, to select a different area.

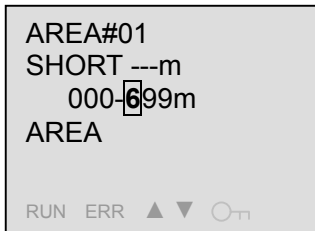

Set the area end distance. Use the **LEFT** and **RIGHT** Buttons to select the digit to be edited.

Use the **UP** and **DOWN** Buttons with a digit selected to change the value.

“**SHORT --- m**” indicates that there is no current short-circuit.

Note: 1. If the area end distance is set to less than 699 m, a new area range will be created. This allows multiple areas to be set.

2. A copy function is supported for easily setting the end distance. A copy function for easily setting the zero shift position is supported. For details, refer to *4.25 Copy Function when Setting Distances*.

3. For details on short-circuiting cables, refer to *4.24 Short-circuiting a Sensing Cable*.



After the area end distance has been set, press the **RIGHT** Button several times to select the area name.

Use the **LEFT** and **RIGHT** Buttons to select the character to be changed.

With the character that is to be changed selected, use the **UP** and **DOWN** Buttons to change the character.

The **DEL** Button can be used to delete the character.

Note: 1. For the characters that can be used for area names, refer to *A.3 Table of Characters* in the Appendices.

2. Up to 8 characters can be set for an area name.

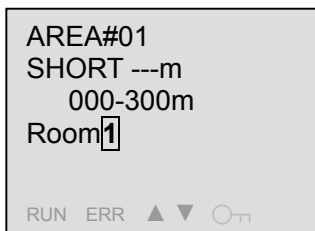

After the area end distance and name have been set, press the **OK** Button.

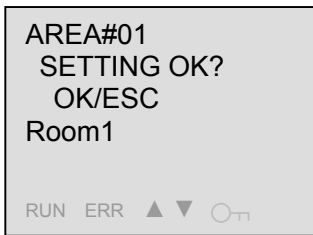

A display will ask for confirmation that the new setting is to be entered. To enter the new setting, press the **OK** Button.

To change the setting before entering it, press the **ESC** Button to return to the previous display.

Note: To abort the setting procedure, press the **ESC** Button until Setting Mode display returns. You will have to press the **ESC** Key several times.

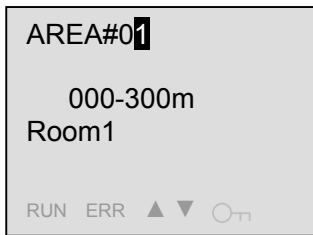

When the changes have been entered, the display will change to a confirmation display. Press the **ESC** Button to return to the Area Selection Display.

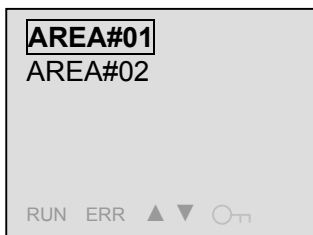

If an edited area end distance that is less than the Sensing Cable length was set, a new area will be created.

To continue editing area ranges, select the area to be edited and perform the same procedure as before.

After area range editing has been completed, press the **ESC** Button several times to return to Setting Mode.

Note: 1. If, for example, the area end distance for area 1 was set to 000 to 300 m, area 2 will be created for 301 to 699 m. Similarly, if the area end distance for area 2 is set to 301 to 400 m, area 3 will be created for 401 to 699 m.

2. A maximum of 20 areas can be created.
3. If a leak occurs at the boundary between two areas, the leak may be detected in the adjacent area. This can be prevented by setting the areas as shown below.
4. Refer to *Editing Detection Areas When Using Sensing Cables and Area Sensors* on the next page for the procedure to set areas when using Area Separators.

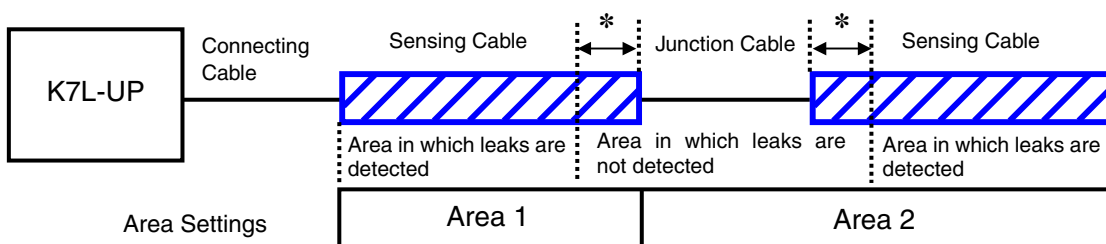

* Set approximately 1% of the total cable length so that leaks are not detected.

■ Editing Detection Areas When Using Sensing Cables and Area Sensors

- Note: 1. Sensing Cables and Area Separators can be combined to enable identifying the detection area in which a leak has occurred even when the leak occurs near an area boundary.
2. Area Separators will be included in the total cable length. Do not let the total cable length exceed 600 m.
3. The distance displayed for each Area Separator is equivalent to 10 m of Sensing Cable.

This section describes how to edit the following detection areas.

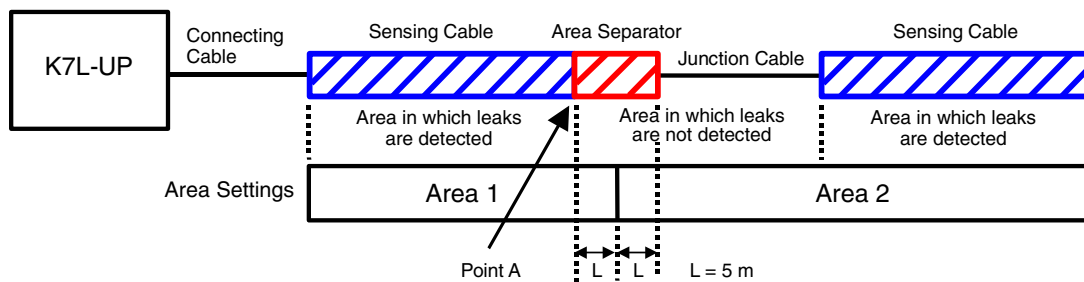

Enter **INPUT**, use the **UP** and **DOWN** Buttons to select **AREA**, and press the **OK** Button.

- Note: 1. For details on how to enter Setting Mode from Monitor Mode, refer to *4.1 Setup Procedures*.
2. For details on entering **INPUT** from Setting Mode, refer to *4.5 Setting the Detection Sensitivity*.
3. In the illustration to the left, the selected item is shown enclosed in a box. In the actual display, the selected item will flash.



When **AREA** is entered, the display will change to a selecting display. Again use the **UP** and **DOWN** Buttons to select **AREA EDIT**, and press the **OK** Button.

- Note: 1. To abort the setting procedure, press the **ESC** Button until Setting Mode display returns. You will have to press the **ESC** Key several times.
2. **AREA EDIT** will not be displayed unless **VALID** is selected for **AREA SET**.

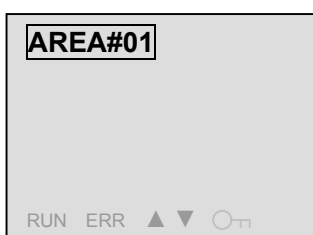

When **AREA SET** is entered, the display will change to the Area Selection Display. Press the **UP** and **DOWN** Buttons to select the area to be edited, and then press the **OK** Button.

- Note: When editing for the first time, only area 1 will be displayed. Each time you set an area, it will enable the next area, i.e., area 2, area 3, etc.



The display will change to the Area Confirmation Display. Press the **OK** Button again.

Note: The display on the left indicates that the current **AREA#01** setting distance is 000 to 699 m, and that the area name is **AREA**. The setting cannot be changed in this state.



With **AREA#01** selected (i.e., with the “1” flashing), press the **RIGHT** Button.

Note: Press the **UP** or **DOWN** Buttons while in the state shown to the left, to select a different area.



Next, short-circuit point A in the figure on the previous page.

The short-circuit position will be displayed within 45 s. Here, point A is at 300 m.

Note: For details on short circuits, refer to 4.24 *Short-circuiting a Sensing Cable*.



Set the area end distance. Use the **LEFT** and **RIGHT** Buttons to select the digit to be edited.

Use the **UP** and **DOWN** Buttons with a digit selected to change the value.

Set the end distance to the short-circuit position plus 5 m.

Here, the short-circuit position is 300 m, so the end distance must be 305 m.

Note: If the short-circuit position is X m, always set the area end distance to X + 5 m.

The displayed cable length is increased from the actual boundary between the areas by adding 5 m from of the center of the Area Separator to enable accurately identifying the detection area in which a leak has occurred.



After the area end distance has been set, press the **RIGHT** Button several times to select the area name.

Use the **LEFT** and **RIGHT** Buttons to select the character to be changed.

With the character that is to be changed selected, use the **UP** and **DOWN** Buttons to change the character.

The **DEL** Button can be used to delete the character.

Note: 1. For the characters that can be used for area names, refer to *A.3 Table of Characters* in the Appendices.

2. Up to 8 characters can be set for an area name.
3. After 45 s has passed from when the short circuit is removed, the short-circuit position will again be displayed as SHORT ---m.

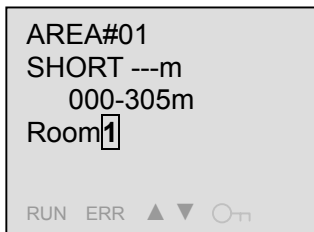

After the area end distance and name have been set, press the **OK** Button.

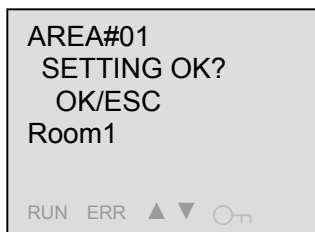

A display will ask for confirmation that the new setting is to be entered. To enter the new setting, press the **OK** Button.

To change the setting before entering it, press the **ESC** Button to return to the previous display.

Note: To abort the setting procedure, press the **ESC** Button until Setting Mode display returns. You will have to press the **ESC** Key several times.

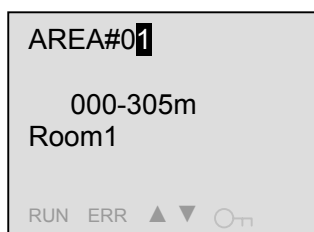

When the changes have been entered, the display will change to a confirmation display. Press the **ESC** Button to return to the Area Selection Display.

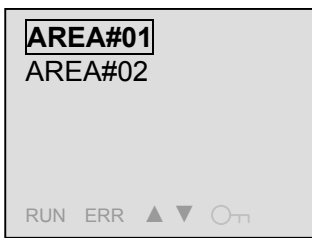

If an edited area end distance that is less than the Sensing Cable length was set, a new area will be created.

To continue editing area ranges, select the area to be edited and perform the same procedure as before.

After area range editing has been completed, press the **ESC** Button several times to return to Setting Mode.

Note: 1. If, for example, the area end distance for area 1 was set to 000 to 305 m, area 2 will be created for 306 to 699 m.

2. A maximum of 20 areas can be created.

Note: When setting areas for Sensing Cables and Area Separators, always short-circuit the Sensing Cable that is connected before the Area Sensor prior to setting the areas.

4.12 Deleting Detection Areas

This section describes how to delete areas that have been set.

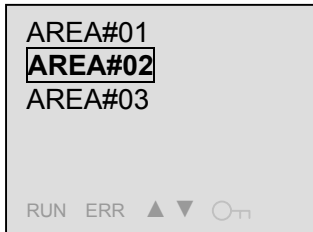

Enter **AREA EDIT**, select the area to be deleted, and then press the **OK** Button.

Note: 1. For details on entering **AREA EDIT**, refer to *4.11 Editing Detection Areas*.

2. In the illustration to the left, the selected item is shown enclosed in a box. In the actual display, the selected item will flash.

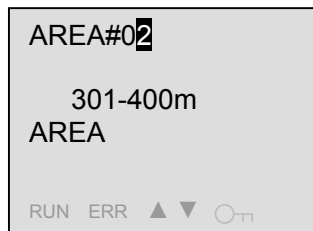

The Area Confirmation Display will appear. Press the **OK** Button.

Note: The display on the left indicates that the current setting for area 2 is 301 to 400 m, and that the area name is **AREA**. The settings cannot be changed or deleted in this state.



Press the **DEL** Button with **AREA#02** selected (i.e., with the “2” flashing).

Note: 1. While in the state shown to the left, press the **UP** or **DOWN** Buttons to select a different area.

2. To abort the setting procedure, press the **ESC** Button until Setting Mode display returns. You will have to press the **ESC** Key several times.

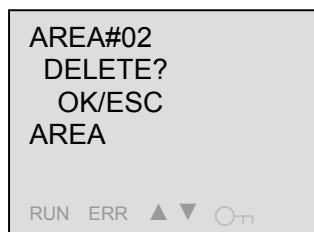

A display will ask for confirmation that the detection area is to be deleted. To delete the area, press the **OK** Button.

To abort the procedure without deleting the area, press the **ESC** Button to return to the previous display.

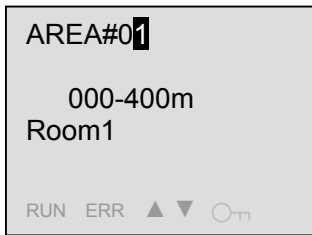

Area 2 will be deleted and the display will change to the Area 1 Confirmation Display. Press the **ESC** Button to return to **AREA EDIT**.

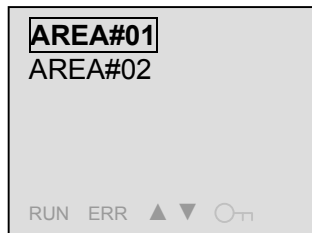

As shown to the left, the number of areas has been changed from three to two.

- Note:
1. The previous area 3 has moved to area 2. The area name set for area 3 will also move to area 2, so reset the name as required.
 2. When only one area is set (i.e., only area 1), area 1 will be initialized if the area is deleted.

4.13 Setting the Relay Output Method

This section describes how to set the relay output method.



Enter Setting Mode, use the **UP** and **DOWN** Buttons to select **OUTPUT**, and press the **OK** Button.

Note: 1. For details on how to enter Setting Mode from Monitor Mode, refer to *4.1 Setup Procedures*.

2. In the illustration to the left, the selected item is shown enclosed in a box. In the actual display, the selected item will flash.



When **OUTPUT** is entered, the display will change to the Relay Output Setting Display. Use the **UP** and **DOWN** Buttons to select **RY-OUT**, and press the **OK** Button.

Note: To abort the setting procedure, press the **ESC** Button until Setting Mode display returns. You will have to press the **ESC** Key several times.

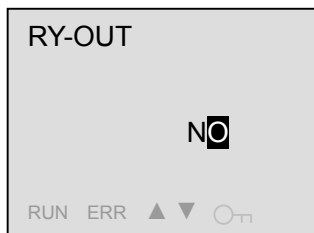

When **RY-OUT** is entered, the display will change to a confirmation display. Press the **OK** Button again to enable changing the setting.

Note: The display on the left indicates that the current **RY-OUT** setting is **NO**. The setting cannot be changed in this state.

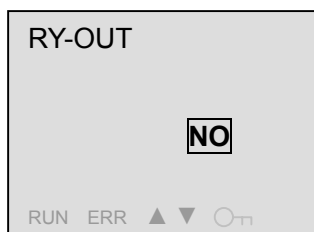

The setting will flash when it can be changed. Press the **UP** and **DOWN** Buttons to set either **NO** or **NC**.

After the setting has been made, press the **OK** Button.

Note: **NO** means normally open, and **NC** means normally closed.

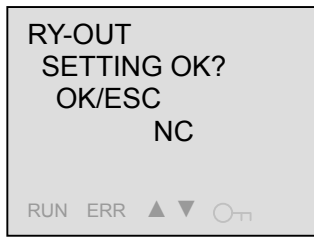

A display will ask for confirmation that the new setting is to be entered. To enter the new setting, press the **OK** Button.

To change the setting before entering it, press the **ESC** Button to return to the previous display.

Note: To abort the setting procedure, press the **ESC** Button until Setting Mode display returns. You will have to press the **ESC** Key several times.



After the setting has been entered, the display will switch back to the confirmation display. Press the **ESC** Button to return to **RY-OUT**.



Press the **ESC** Button to return to Setting Mode.

4.14 Setting the Output Reset Method

This section describes how to set output reset method.

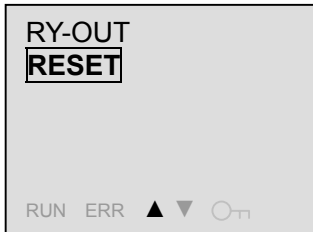

Enter **OUTPUT**, use the **UP** and **DOWN** Buttons to select **RESET**, and press the **OK** Button.

Note: 1. For details on how to enter Setting Mode from Monitor Mode, refer to *4.1 Setup Procedures*.

2. For details on entering OUTPUT from Setting Mode, refer to *4.13 Setting the Relay Output Method*.

3. In the illustration to the left, the selected item is shown enclosed in a box. In the actual display, the selected item will flash.



When **RESET** is entered, the display will change to a confirmation display. Press the **OK** Button again to enable changing the setting.

Note: The display on the left indicates that the current **RESET** setting is **MANU2**. The setting cannot be changed in this state.



The setting will flash when it can be changed. Press the **UP** and **DOWN** Buttons to change the setting to **AUTO**, **MANU1**, or **MANU2**.

After the change has been made, press the **OK** Button.



A display will ask for confirmation that the new setting is to be entered. To enter the new setting, press the **OK** Button.

To change the setting before entering it, press the **ESC** Button to return to the previous display.

Note: To abort the setting procedure, press the **ESC** Button until Setting Mode display returns. You will have to press the **ESC** Key several times.



After the setting has been entered, the display will switch back to the confirmation display.

Press the **ESC** Button to return to **RESET**.

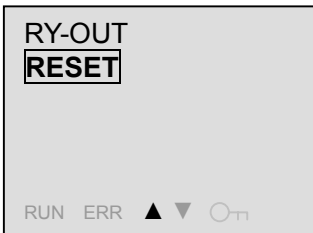

Press the **ESC** Button to return to Setting Mode.

Reset Methods

Setting	Display	Operation
Automatic	AUTO	The outputs are automatically reset after the leak or disconnection is corrected. The outputs cannot be reset while the leak or disconnection is still in effect.
Manual 1	MANU1	The outputs are automatically reset after the leak or disconnection is corrected. Even if the leak or disconnection is still being detected, the alarm output can be reset manually.
Manual 2	MANU2	After the leak or disconnection has been corrected, the outputs will continue until they are reset manually. Even if the leak or disconnection is still being detected, the alarm output can be reset manually.

Note: 1. A reset is performed by pressing the **ESC** and **ALT** Buttons simultaneously when a leak or disconnection has been detected. An external reset is enabled by short-circuiting the external reset terminals.

2. When manual 1 or manual 2 is set, only the alarm output can be reset manually. Leakage/disconnection outputs and the LCD backlight are not reset. For details on reset operations, refer to *3.4 Operation Timecharts*.

4.15 Setting Communications

This section describes how to make settings related to RS-485 communications.



Enter Setting Mode, use the **UP** and **DOWN** Buttons to select **RS485**, and press the **OK** Button.

Note: 1. For details on how to enter Setting Mode from Monitor Mode, refer to *4.1 Setup Procedures*.

2. In the illustration to the left, the selected item is shown enclosed in a box. In the actual display, the selected item will flash.



When **RS485** is entered, the display will change to the Communications Protocol Confirmation Display. Press the **OK** Button again to enable changing the setting.

Note: The display on the left indicates that the current setting is CompoWay/F. The setting cannot be changed in this state.



The communications protocol name will flash when the setting can be changed. Press the **UP** and **DOWN** Buttons to set either **CompoWay/F** or **MODBUS**.

After the setting has been made, press the **OK** Button.

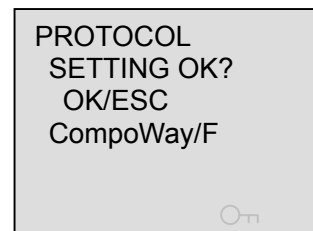

A display will ask for confirmation that the new setting is to be entered. To enter the new setting, press the **OK** Button.

To change the setting before entering it, press the **ESC** Button to return to the previous display.

Note: To abort the setting procedure, press the **ESC** Button until Setting Mode display returns. You will have to press the **ESC** Key several times.



When the setting is entered, the display will change to the Communications Setting Display. Use the **UP** and **DOWN** Buttons to select the setting to be changed, and then press the **OK** Button. Make the settings according to the communications settings of the host device.

- Note: 1. The flow of operation from making the communications settings to entering them is the same as for the other settings.
2. Refer to the table below for details on communications settings.



After the settings have been made, press the **ESC** Button several times to return to Setting Mode.

■ Communications Settings

Item	Display	Setting range	
		CompoWay/F	MODBUS
Unit number	NODE NO.	00 to 99	01 to 99
Baud rate	BAUD RATE	4,800, 9,600, 19,200, or 38,400 bps	
Data bit length	DATA LENGTH	7 bits or 8 bits	8 bits
Stop bit length	STOP BITS	1 bit or 2 bits	Set automatically according to the parity bit setting. No parity bit: 2 bits With parity bit: 1 bit
Parity bit	PARITY	Even, odd, or none	
Communications response send delay	WAITING TIME	00 to 99	

4.16 Setting the Linear Output (4 to 20 mA)

This section describes how to set the linear output (4 to 20 mA).

- Note: 1. Before setting the linear output (4 to 20 mA), first set the zero shift and correction value. For details on entering the Zero Shift Display from Setting Mode, refer to *4.6 Enabling the Zero Shift*. For details on entering **CORR** from Setting Mode, refer to *4.8 Enabling the Correction*.
2. Depending on the location of the leak, 6 to 18 mA will be output. The location of the leak that would output 18 mA can be set. The location of the leak that outputs 6 mA is always 0 m.



Enter Setting Mode, use the **UP** and **DOWN** Buttons to select **4-20 mA**, and press the **OK** Button.

Note: 1. For details on how to enter Setting Mode from Monitor Mode, refer to *4.1 Setup Procedures*.

2. In the illustration to the left, the selected item is shown enclosed in a box. In the actual display, the selected item will flash.

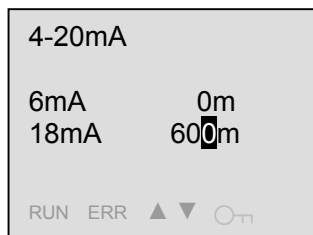

When **4-20 mA** is entered, the display will change to a confirmation display. Press the **OK** Button.

Note: The display on the left indicates that the current setting is 6 mA at 0 m (fixed) and 18 mA at 600 m. The setting cannot be changed in this state.



The distance for 18-mA output can now be set. Use the **LEFT** and **RIGHT** Buttons to select the digit to be edited. Use the **UP** and **DOWN** Buttons with a digit selected to change the value.

- Note: 1. The distance for 6-mA output is always 0 m. The actual 0 m is the distance specified by the Zero Shift setting.
2. If a leak occurs at more than the set distance for 18-mA output, the output will remain at 20 mA.
3. For details on short-circuiting cables, refer to *4.24 Short-circuiting a Sensing Cable*.
4. A copy function is supported that enables the distance to be easily set for the maximum output. A copy function for easily setting the zero shift position is supported. For details, refer to *4.25 Copy Function when Setting Distances*.

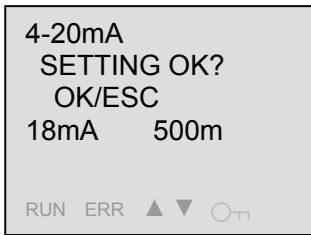

A display will ask for confirmation that the new setting is to be entered. To enter the new setting, press the **OK** Button.

To change the setting before entering it, press the **ESC** Button to return to the previous display.

Note: To abort the setting procedure, press the **ESC** Button until Setting Mode display returns. You will have to press the **ESC** Key several times.

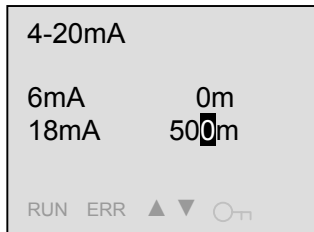

After the setting has been entered, the display will switch back to the confirmation display. Press the **ESC** Button to return to Setting Mode.

Note: Relation between the Output When a Leak Is Detected and the Set Distance

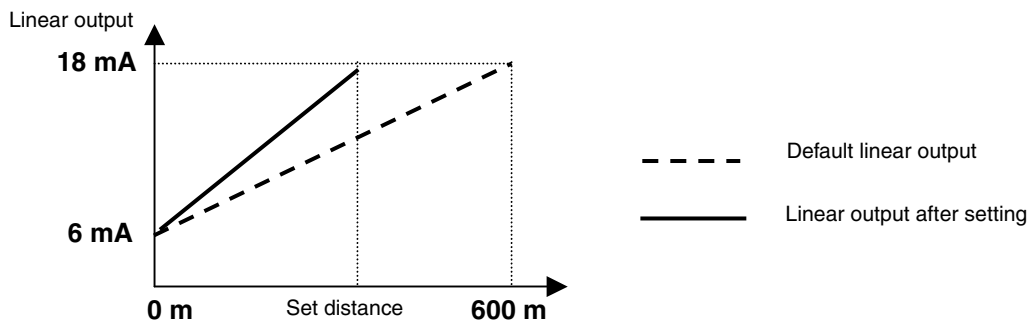

The output when a leak is detected can be calculated from the following formula.

$$\text{Linear output} = 6 + 12 \times \text{Leak position (m)} / L \text{ (m)} \text{ mA}$$

Note: 1. L is the set distance (default: 600).

2. When an error is detected, 5 mA will be output. When a disconnection is detected, 20 mA will be output. When no leak, disconnection, error, or other event has occurred, 4 mA will be output.

4.17 Output Test Method for the Leak Detection Test

This section describes how to perform a leak detection test.

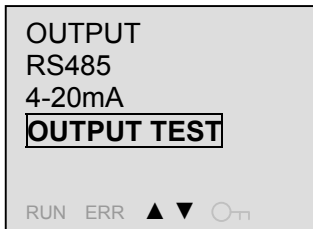

Enter Setting Mode, use the **UP** and **DOWN** Buttons to select **OUTPUT TEST**, and press the **OK** Button.

Note: 1. For details on how to enter Setting Mode from Monitor Mode, refer to *4.1 Setup Procedures*.

2. In the illustration to the left, the selected item is shown enclosed in a box. In the actual display, the selected item will flash.



When **OUTPUT TEST** is entered, the display will change to the Output Test Selection Display. Use the **UP** and **DOWN** Buttons to select **LEAK**, and press the **OK** Button.

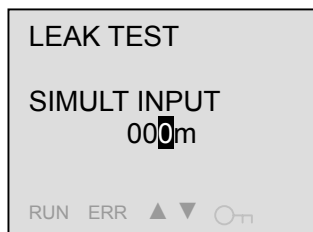

When **LEAK** is entered, the display will change to a confirmation display. Press the **OK** Button again to enable changing the setting.

Note: The display on the left indicates that the current setting is 0 m. The setting cannot be changed in this state.

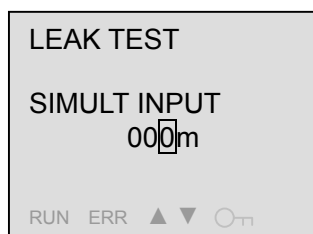

The simulation input distance will flash when the setting can be changed. Use the **LEFT** and **RIGHT** Buttons to select the digit to be changed.

With the digit to be changed selected, use the **UP** and **DOWN** Buttons to change the number.

After the change has been made, press the **OK** Button to start the test.

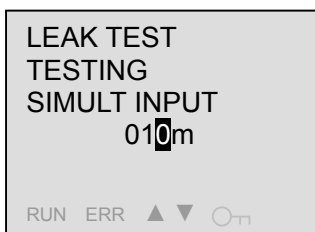

When the output test is started, the display will change to the one shown to the left. The linear output will be output according to the alarm output, leakage/disconnection detection output, and simulation input distance.

If the reset has been set to **MANU1** or **MANU2**, the alarm output can now be stopped by simultaneously pressing the **ESC** and **ALT** Buttons.

Note: For details on entering the Reset Display from Setting Mode, refer to *4.14 Setting the Output Reset Method*.

To set the simulation input distance again, press the **OK** Button to return to the previous display and then change the setting.

When the leak detection test has been completed, press the **ESC** Button.

Note: To abort the setting procedure, press the **ESC** Button until Setting Mode display returns. You will have to press the **ESC** Key several times.



To perform another output test, use the **UP** and **DOWN** Buttons to select a test item and then press the **OK** Button.

When the output test has been completed, press the **ESC** Button to return to Setting Mode.

4.18 Output Test Method for the Disconnection Detection Test

This section describes how to perform a disconnection detection test.

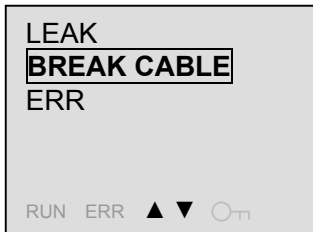

Enter the Output Test Selection Display, use the **UP** and **DOWN** Buttons to select **BREAK CABLE**, and press the **OK** Button.

- Note:
1. For details on how to enter Setting Mode from Monitor Mode, refer to *4.1 Setup Procedures*
 2. For details on entering **OUTPUT TEST** from Setting Mode, refer to *4.17 Output Test Method for the Leak Detection Test*.
 3. In the illustration to the left, the selected item is shown enclosed in a box. In the actual display, the selected item will flash.

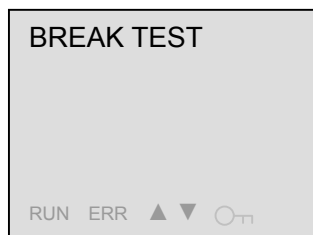

When **BREAK CABLE** is entered, the display will change to a confirmation display. Press the **OK** Button to start the test.

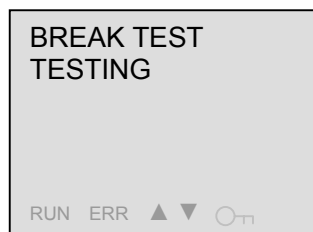

When the disconnection detection test is started, the display will change to the one shown to the left. The linear output will be output according to the alarm output, leakage/disconnection detection output, and disconnection status.

If the reset has been set to **MANU1** or **MANU2**, the alarm output can now be stopped by simultaneously pressing the **ESC** and **ALT** Buttons.

Note: For details on entering the Reset Display from Setting Mode, refer to *4.14 Setting the Output Reset Method*.

When the disconnection detection test has been completed, press the **ESC** Button.

Note: To abort the setting procedure, press the **ESC** Button until Setting Mode display returns. You will have to press the **ESC** Key several times.

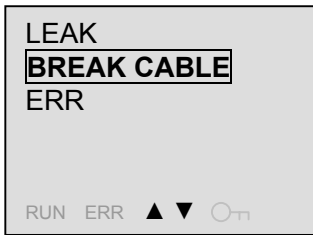

To perform another output test, press the **UP** or **DOWN** Button one or more times to select a test item and then press the **OK** Button.

After the output test has been completed, press the **ESC** Button to return to Setting Mode.

4.19 Output Test Method for the Error Detection Test

This section describes how to perform an error detection test.



Enter the Output Test Selection Display, use the **UP** and **DOWN** Buttons to select **ERR**, and press the **OK** Button.

- Note:
1. For details on how to enter Setting Mode from Monitor Mode, refer to *4.1 Setup Procedures*.
 2. For details on entering a test from Setting Mode, refer to *4.17 Output Test Method for the Leak Detection Test*.
 3. In the illustration to the left, the selected item is shown enclosed in a box. In the actual display, the selected item will flash.

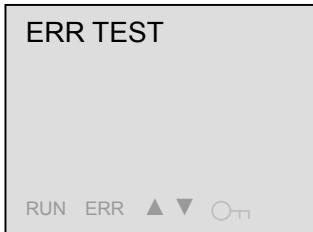

When **ERR** is entered, the display will change to a confirmation display. Press the **OK** Button to start the test.

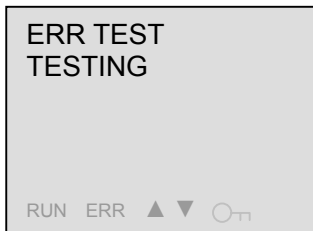

When the output test is started, the display will change to the one shown to the left. The linear output will be output according to the alarm output, leakage/disconnection detection output, and error status.

If the reset has been set to **MANU1** or **MANU2**, the alarm output can now be stopped by simultaneously pressing the **ESC** and **ALT** Buttons.

Note: For details on entering the Reset Display from Setting Mode, refer to *4.14 Setting the Output Reset Method*.

After the error detection test has been completed, press the **ESC** Button.

Note: To abort the setting procedure, press the **ESC** Button until Setting Mode display returns. You will have to press the **ESC** Key several times.

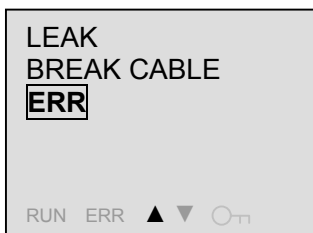

To perform another output test, use the **UP** and **DOWN** Buttons to select a test item and then press the **OK** Button.

After the output test has been completed, press the **ESC** Button to return to Setting Mode.

4.20 Setting the Backlight ON Time

This section describes how to set the backlight ON time.

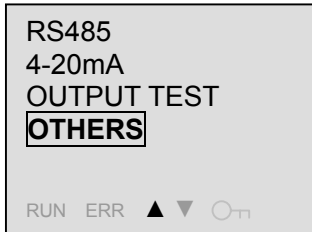

Enter Setting Mode, use the **UP** and **DOWN** Buttons to select **OTHERS**, and press the **OK** Button.

Note: 1. For details on how to enter Setting Mode from Monitor Mode, refer to *4.1 Setup Procedures*.

2. In the illustration to the left, the selected item is shown enclosed in a box. In the actual display, the selected item will flash.

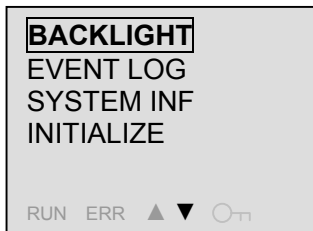

When **BACKLIGHT** is entered, the display will change to the Item Selection Display. Use the **UP** and **DOWN** Buttons to select **BACKLIGHT**, and press the **OK** Button.

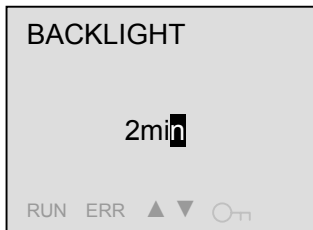

When **BACKLIGHT** is entered, the display will change to a confirmation display. Press the **OK** Button again to enable changing the setting.

Note: The display on the left indicates that the current setting is 2 min. The setting cannot be changed in this state.



The ON time will flash when the setting can be changed. Use the **UP** and **DOWN** Buttons to select 2 min, 10 min, 30 min, or always ON, and then press the **OK** Button.

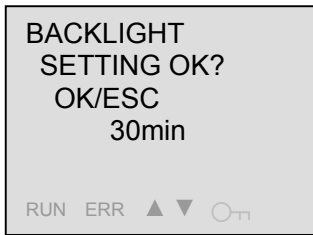

A display will ask for confirmation that the new setting is to be entered. To enter the new setting, press the **OK** Button.

To change the setting before entering it, press the **ESC** Button to return to the previous display.

Note: To abort the setting procedure, press the **ESC** Button until Setting Mode display returns. You will have to press the **ESC** Key several times.

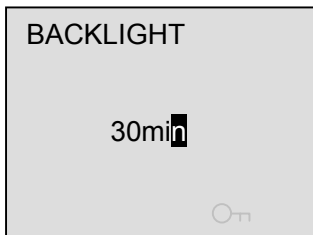

After the setting has been entered, the display will switch back to the confirmation display. Press the **ESC** Button to return to **BACKLIGHT**.

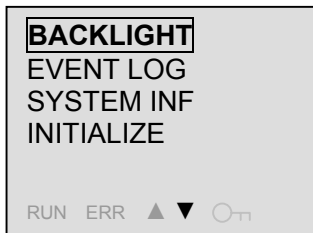

Press the **ESC** Button to return to Setting Mode.

4.21 Checking the Event Logs

This section describes how to check the event logs.

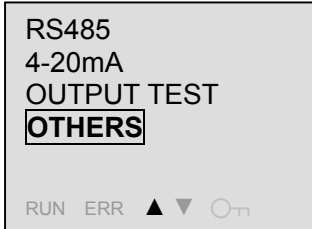

Enter Setting Mode, use the **UP** and **DOWN** Buttons to select **OTHERS**, and press the **OK** Button.

Note: 1. For details on how to enter Setting Mode from Monitor Mode, refer to *4.1 Setup Procedures*.

2. In the illustration to the left, the selected item is shown enclosed in a box. In the actual display, the selected item will flash.



When **OTHERS** is entered, the display will change to the Item Selection Display. Press the **UP** and **DOWN** Buttons to select **EVENT LOG**, and then press the **OK** Button.



When **EVENT LOG** is entered, the display will change to the Log Selection Display. Press the **UP** and **DOWN** Buttons to select the event log to be checked, and then press the **OK** Button.

Note: A maximum of 20 event logs are saved. If more than 20 events occur, logs are deleted beginning with the oldest.



The contents of the event log can be checked in the Log Confirmation Display. The **UP** and **DOWN** Buttons can be used for scrolling the display.

When finished checking, press the **ESC** Button.



To check another event log, use the **UP** and **DOWN** Buttons to select the event log to check and then press the **OK** Button.

When finished, press the **ESC** Button to return to the previous display.

Note: To abort the setting procedure, press the **ESC** Button until Setting Mode display returns. You will have to press the **ESC** Key several times.

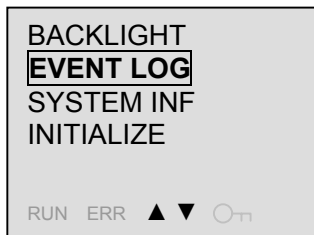

Press the **ESC** Button to return to Setting Mode.

4.22 Checking System Information

This section describes how to check system information.

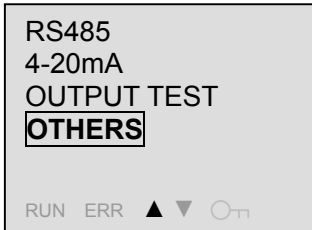

Enter Setting Mode, use the **UP** and **DOWN** Buttons to select **OTHERS**, and press the **OK** Button.

Note: 1. For details on how to enter Setting Mode from Monitor Mode, refer to *4.1 Setup Procedures*.

2. In the illustration to the left, the selected item is shown enclosed in a box. In the actual display, the selected item will flash.

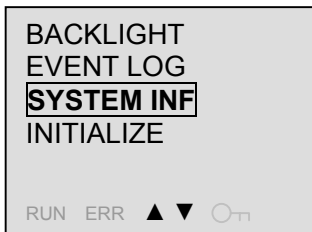

When **OTHERS** is entered, the display will change to the Item Selection Display. Use the **UP** and **DOWN** Buttons to select **SYSTEM INF**, and then press the **OK** Button.

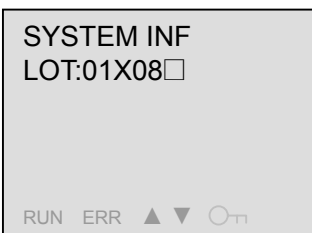

When **SYSTEM INF** is entered, the display will change to the Lot Number Confirmation Display.

When finished checking, press the **ESC** Button.

Note: The lot number indicates the production date.

Lot.: DDMYY□

DD: Production date, 0 to 31

M: Production month: 0 to 9, X, Y, Z

(X: Oct., Y: Nov., Z: Dec.)

YY: Production year: rightmost digits 00 to 99

□: Production site ID: A(a) to Z(z), or none

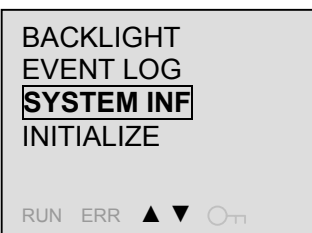

Press the **ESC** Button to return to Setting Mode.

4.23 Initialization Method

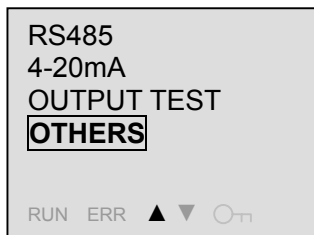

Enter Setting Mode, use the **UP** and **DOWN** Buttons to select **OTHERS**, and press the **OK** Button.

- Note: 1. For details on how to enter Setting Mode from Monitor Mode, refer to *4.1 Setup Procedures*.
2. In the illustration to the left, the selected item is shown enclosed in a box. In the actual display, the selected item will flash.

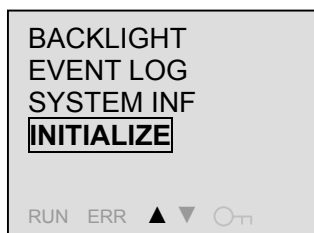

When **OTHERS** is entered, the display will change to the Item Selection Display. Press the **UP** or **DOWN** Button one or more times to select **INITIALIZE**, and then press the **OK** Button.

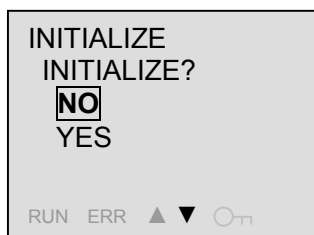

The display will change to the Initialization Selection Display. Use the **UP** and **DOWN** Buttons to select **YES**, and then press the **OK** Button.

- Note: 1. To abort the setting procedure, press the **ESC** Button until Setting Mode display returns. You will have to press the **ESC** Key several times.
2. Be careful when initializing, because the contents of all settings will be deleted and cannot be restored without setting them individually again.
3. The event logs are not initialized when an initialization is executed.

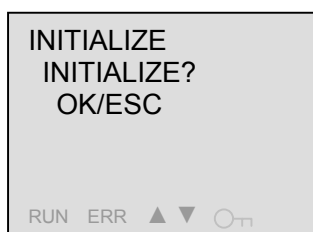

A display will ask for confirmation that the new setting is to be entered. To enter the new setting, press the **OK** Button.

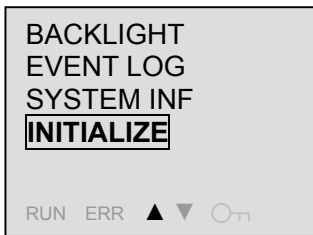

Press the **OK** Button to initialize all the settings to their defaults.

- Note: 1. Be careful when initializing, because the contents of all settings will be deleted and cannot be restored without setting them individually again.
2. The event logs are not initialized when an initialization is executed.

4.24 Short-circuiting a Sensing Cable

This section describes how to short-circuit a Sensing Cable to check operation for the zero shift setting, area settings, and linear output (4 to 20 mA) setting.

■ Description of Displays



When there is no short-circuit, **SHORT ---m** will be displayed as shown to the left.



If the short-circuit position is 300 m, then **SHORT 300m** will be displayed as shown to the left.

■ Short-circuiting a Sensing Cable

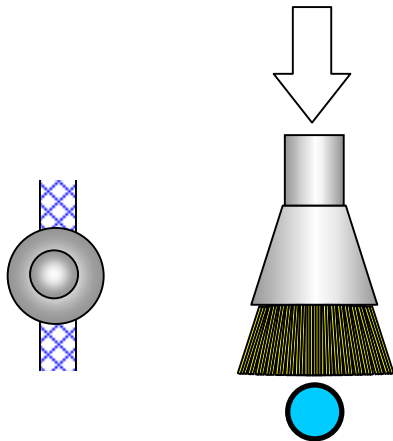

Press a commercially available metal brush against the Sensing Cable for at least 45 s.

Recommended pressure: 10 N

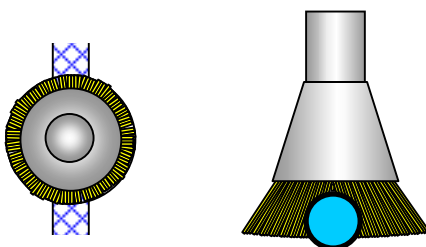

Press the brush down until the K7L-UP-FLK operates or a distance is displayed for “---” in **SHORT ---m**. This may require 45 s or longer.

Note: If the short-circuit brush is released too soon, or if the short-circuit is insufficient, the short-circuit may not be displayed correctly.

4.25 Copy Function when Setting Distances

This section describes the copy function that can be used to input distances.

What Is the Copy Function?

The copy function can be conveniently used when setting the zero shift, areas, or linear output (4 to 20 mA). The position where the Sensing Cable is short-circuited by a metal brush can be pasted to input a distance setting.



Enter the Area Edit Display and move the cursor using the **RIGHT** Button.

Note: 1. For details on entering the Area Edit Display, refer to *4.11 Editing Detection Areas*.

2. In the illustration to the left, the selected item is shown enclosed in a box. In the actual display, the selected item will flash.



With the cursor at the area end distance setting, short-circuit the Sensing Cable at the position that corresponds to the area 1 end distance.

Note: 1. For details on short-circuiting cables, refer to *4.24 Short-circuiting a Sensing Cable*.

2. To abort the setting procedure, press the **ESC** Button until Setting Mode display returns. You will have to press the **ESC** Key several times.



If the Sensing Cable short-circuited position is 300 m, then **SHORT 300m** will be displayed as shown to the left. Check to make sure that the cursor is at the area end distance, and then press the **LEFT** and **RIGHT** Buttons simultaneously for 3 s.



Confirm that the short-circuit value has been copied, and then press the **OK** Button.

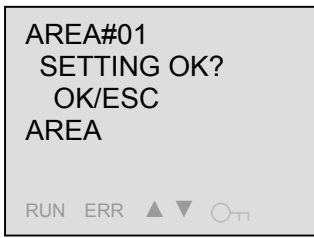

A display will ask for confirmation that the new setting is to be entered. To enter the new setting, press the **OK** Button.

To change the setting before entering it, press the **ESC** Button to return to the previous display.

Note: To abort the setting procedure, press the **ESC** Button until Setting Mode display returns. You will have to press the **ESC** Key several times.



When the changes have been entered, the display will change to a confirmation display. Press the **ESC** Button to return to the Area Selection Display.

4.26 Setting Protection

This section describes how to set protection.



In the Monitor Display, press the **DEL** and **ALT** Buttons for 3 s to enter the Protection Mode.



When the Protection Mode is entered, the display will change to the one shown to the left. Press the **OK** Button again to enable changing the setting.

Note: The display on the left indicates that the current setting is level 0. The setting cannot be changed in this state.



The protect level will flash when the setting can be changed. Press the **UP** and **DOWN** Buttons to change to the level that is to be set (**LEVEL1** in this case).

Note: In the illustration to the left, the selected item is shown enclosed in a box. In the actual display, the selected item will flash.



After the setting has been made, press the **OK** Button.

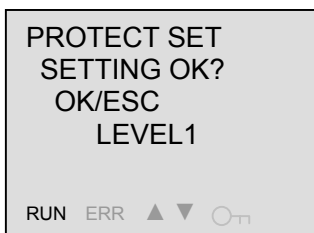

A display will ask for confirmation that the new setting is to be entered. To enter the new setting, press the **OK** Button.

To change the setting before entering it, press the **ESC** Button to return to the previous display.



Note: To abort the setting procedure, press the **ESC** Button until Setting Mode display returns. You will have to press the **ESC** Key several times.



After the setting has been entered, the display will switch back to the confirmation display. Press the **DEL** and **ALT** Buttons for at least 1 s to return to the Monitor Display.

Note: If the protection is set to level 1 or level 2, the  icon will light.

■ Protection Settings

Protection level	Button procedures	Checking settings	Changing settings	Icon
Level 0	OK	OK	OK	
Level 1	OK	OK	Disabled	
Level 2	Disabled	Disabled	Disabled	

Note: Only the following button procedures are possible in level 2.

- Reset (Press the **ESC** and **ALT** Buttons simultaneously.)
- Moving to Protection Mode (Press the **DEL** and **ALT** Buttons simultaneously.)



Section 5

Communications Methods

This section describes the communications methods, communications specifications, and communications connections. Read this section before installing the system devices.

5.1	Overview of Communications Methods.....	5-2
-----	---	-----

5.1 Overview of Communications Methods

■ Introduction

Communications are implemented by creating a program on the host computer to monitor or change the settings of the K7L-UP-FLK. The descriptions in this section are from the perspective of the host computer.

CompoWay/F is an OMRON protocol for general-purpose serial communications. CompoWay/F features a unified frame format and FINS*-compliant commands, which have a long record of successful use with OMRON Programmable Logic Controllers. CompoWay/F simplifies communications between the host computer and components.

* FINS (Factory Interface Network Service)

FINS is a protocol for message communications between Controllers on an OMRON factory automation network.

Modbus communications are based on the RTU Mode of the Modbus Protocol of Modicon Inc. (specifications: PI-MBUS-300 Revision J). It supports the same functionality as CompoWay/F, including the following commands: Read from Variable Area, Write to Variable Area, Operation Command, and Echoback Test.

The K7L-UP-FLK has the following communications functions:

- Reading and writing parameters
- Operation commands

■ Communications Specifications

Communications protocol	CompoWay/F	Modbus (RTU)
Transmission line connection	Multidrop	
Communications standard	RS-485 (2-wire, half duplex)	
Synchronization method	Start-stop synchronization	
Baud rate	4.8, 9.6 , 19.2, or 38.4 kbps	
Communications code	ASCII	Binary
Data bit length	7 or 8 bits	Always 8 bits (no setting)
Stop bit length	1 or 2 bits	The stop bit length is automatically set according to the parity bit setting. (The user cannot set it.) No parity bit: 2 bits With parity bit: 1 bit
Error detection	Parity bit: None, even, or odd BCC (Block Check Character)	Parity bit: None, even , or odd CRC-16 (Cyclical Redundancy Check)
Flow control	None	
Interface	RS-485	
Retry function	None	

Note: The parameters can be set independently using RS-485 settings. (The default protocol is CompoWay/F.) Default settings are shaded in the above table.

■ Transfer Protocol

The host computer sends a command frame, and the K7L-UP-FLK returns a response frame based on the contents of the command frame. One response frame is sent in response to one command frame. The following describes the operation of the command frame and the response frame.

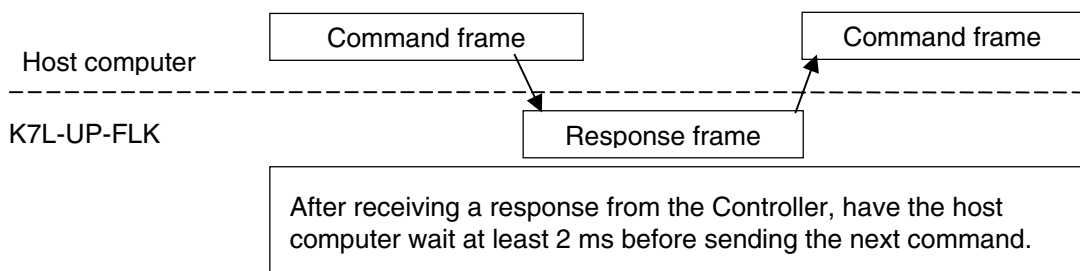

■ Interface

Communications with the host computer are performed through a standard RS-485 interface. Use a K3SC Interface Converter for RS-485 interface conversion.

■ Connections RS-485

The connection type is 1:1 or 1:N. Up to 32 nodes including the host computer can be connected in a 1:N system

The maximum total cable length is 500 m. Use shielded twist-pair cable (AWG16 to AWG28). Use a 120-Ω (1/2-W) terminating resistor.

Set the same communications specifications for the host computer and the K7L-UP-FLK. If 1:N connections are used, set the same communications specifications for all nodes. Set unique values, however, for the communications unit numbers.

This section describes how to set the communications specifications of the K7L-UP-FLK.

■ Communications Parameters

Set the communications specifications of the K7L-UP-FLK using RS-485. Make the settings for the communications parameters on the panel of the K7L-UP-FLK. The following table describes the communications parameters.

Item	Set values	Description
Communications protocol	CompoWay/F or Modbus	CompoWay/F or Modbus
Unit number	00 to 99	00 to 99 (default: 01)
Baud rate	4.8, 9.6, 19.2, or 38.4 (kbps)	4.8, 9.6, 19.2, or 38.4 (kbits/s)
Data bit length	7 or 8 (bits)	7 or 8 (bits)
Stop bit length	1 / 2	1 or 2 (bits)
Parity bit	None, even, or odd	None, even, or odd
Communications response send delay	00 to 99 (ms)	00 to 99 (ms) (default: 20 ms)

Note: Default settings are shaded in the above table.

- Protocol Selection

The communications protocol can be set to CompoWay/F or Modbus.

- Unit Number

Set a unit number so that the host computer can identify each node when communications are performed from the host computer. The unit number can be set between 0 and 99 in increments of 1. The default setting is 1. When two or more node are used, do not set the same unit number more than once. Doing so will prevent normal operation. (Set Modbus communications unit numbers to between 1 and 99.)

- Baud Rate

Set the baud rate for communications with the host computer. The following baud rates can be set:

4.8 (4,800 bits/s), 9.6 (9,600 bits/s), 19.2 (19,200 bits/s), or 38.4 (38,400 bits/s)

- Data Bit Length

The data bit length can be set to 7 bits or 8 bits. (For Modbus, the data length is always 8 bits.)

- Stop Bit Length

The stop bit length can be set to 1 or 2 bits.

For Modbus, the stop bit length is automatically set according to the communications parity setting (Parity: 1 bit, No parity: 2 bits).

- Parity Bit

The parity bit can be set to none, even, or odd.

- Communications Response Send Delay

The communications response send delay can be set to between 0 and 99 ms in increments of 1 ms. The default setting is 20 ms.

Section 6

CompoWay/F Communications Procedure

Read this section before performing communications using the CompoWay/F protocol.

6.1	Data Format.....	6-2
6.2	Command Text Structure	6-6
6.3	Service Details	6-9
6.4	List of Response Codes.....	6-20

6.1 Data Format

Hexadecimal values are expressed by adding “hex” after the number, e.g., 02 hex. Numbers shown without the hex suffix are ASCII characters. The number underneath each item in the frame indicates the number of bytes.

■ Command Frames

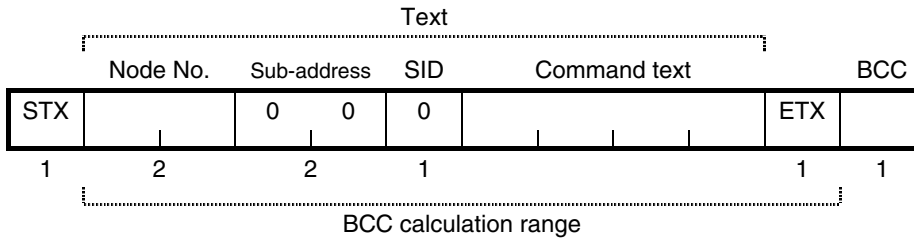

STX	A code that indicates the beginning of a communications frame (02 hex). Be sure to set this code in the first byte.
Node No.	The unit number of the K7L-UP-FLK. The number can be set to between 00 and 99 or “XX” (uppercase characters). Specify “XX” to broadcast a transmission. No responses will be returned for broadcast transmissions.
Sub-address	Not used with the K7L-UP-FLK, so always set to 00.
SID (Service ID)	Not used with the K7L-UP-FLK, so always set to 0.
FINS-mini command text	The text of the command.
ETX	A code that indicates the end of the text (03 hex).
BCC	Block Check Character This byte stores the result of the BCC calculation from the node number through EXT.

■ BCC Calculation Example

BCC (Block Check Character) calculates the exclusive OR for each byte from the node number to ETX and sets the 8-bit data for the BCC.

STX	Node No.		Sub-address		SID	Command text			ETX	BCC	
02 hex	0 (30 hex)	0 (30 hex)	0 (30 hex)	0 (30 hex)	0 (30 hex)	0 (30 hex)	5 (35 hex)	0 (30 hex)	3 (33 hex)	03 hex	35 hex

$$\text{BCC} = 30 \oplus 30 \oplus 30 \oplus 30 \oplus 30 \oplus 30 \oplus 35 \oplus 30 \oplus 33 \oplus 03 = 35 \text{ hex}$$

The result of the calculation (35 hex) is written to the BCC byte.

The \oplus symbols indicate XOR (exclusive OR) operations.

■ Response Frames

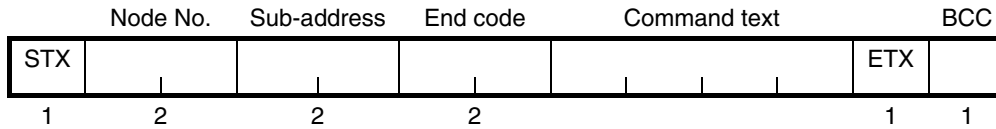

End code	Name	Meaning	Error detection priority
00	Normal end	Command was executed normally without error.	None
0F	FINS command error	Could not execute the specified FINS command. Refer to the FINS response code to determine why the command was not executed.	8
10	Parity error	Sum of bits that are "1" in received data did not agree with the communications parity.	2
11	Framing error	The stop bit length is 0.	1
12	Overrun error	Attempted to transfer new data when reception data buffer is already full.	3
13	BCC error	Calculated BCC value is different from received BCC value.	5
14	Format error	Characters other than 0 to 9 or A to F were used in the command text. This error is not applicable to the echoback test. (For details, refer to <i>Echoback Test</i> in Section 6.3.) No SID and command text. Or, no command text. "MRC/SRC" not included in command text.	7
16	Sub-address error	The sub-address is illegal (i.e., not supported). There was no sub-address, SID, and command text. The sub-address was less than two characters, and there was no SID and command text.	6
18	Frame length error	The command frame exceeds the specified number of bytes.	4

- An end code is returned for each command frame received that was addressed to the local node.
- No response will be returned unless the command frame contains all elements up to the ETX and BCC.
- The *Error Detection Priority* is the priority when two or more errors occur simultaneously.

■ End Code Example

The following examples show the end code when a command did not end normally.

Example 1: Incorrect Sub-address and No SID or Command Text

• **Command**

	Node No.	Sub-address	BCC
STX		0 A	ETX

• **Response**

	Node No.	Sub-address	End code	BCC
STX		0 A	1 6	ETX

The end code is 16 (sub-address error). The sub-address error code is used because the sub-address error has a higher error detection priority than the format error.

Example 2: No Command Text

• **Command**

	Node No.	Sub-address	SID	BCC
STX		0 0	0	ETX

• **Response**

	Node No.	Sub-address	End code	BCC
STX		0 0	1 4	ETX

The end code is 14 (format error).

Example 3: Not All Node Addresses Provided

• **Command**

	Node No.	Sub-address	BCC
STX		ETX	

The node number is missing one character.

• **Response**

There is no response.

Example 4: No Sub-address and Illegal BCC• **Command**

Node No.		BCC	
STX		ETX	Err

• **Response**

Node No.		Sub-address		End code		BCC	
STX		0	0	1	3	ETX	

The sub-address is 00 and the end code is 13 (BCC error).

6.2 Command Text Structure

■ PDU Structure

An MRC (Main Request Code) and SRC (Sub-Request Code) followed by the various required data is transferred as the command text.

- **Service Request PDU**



The MRES (Main RESponse code) and SRES (Sub-RESponse code) are transferred in the response frame following the above MRC/SRC. Data is then transferred following the MRES and SRES.

- **Service Response PDU (Normal Response)**

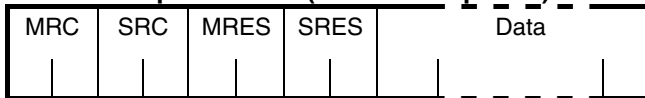

If the specified command text could not be executed, the service response PDU will contain only the MRC/SRC and MRES/SRES.

- **Service Response PDU (Command Text Not Included)**

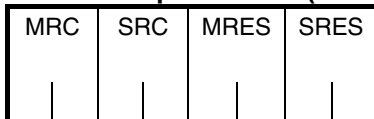

The MRES and SRES become the response code when processing did not end normally.

Note: In this manual, MRES and SRES are given consecutively as the response command.

■ Area Definitions

Only the variable area can be accessed.

■ Type Codes (Variable Types)

The following table lists the variable types in the variable area.

Variable type	Description
80	Event information
81	Operation parameters
82	Communications parameters
83	Event log 1
84	Event log 2
85	Event log 3
86	Event log 4
87	Event log 5
88	Event log 6
89	Event log 7
8A	Event log 8
8B	Event log 9
8C	Event log 10
8D	Event log 11
8E	Event log 12
8F	Event log 13
90	Event log 14
91	Event log 15
92	Event log 16
93	Event log 17
94	Event log 18
95	Event log 19
96	Event log 20
A1	Area 1
A2	Area 2
A3	Area 3
A4	Area 4
A5	Area 5
A6	Area 6
A7	Area 7
A8	Area 8
A9	Area 9
AA	Area 10
AB	Area 11
AC	Area 12
AD	Area 13
AE	Area 14
AF	Area 15
B0	Area 16
B1	Area 17
B2	Area 18
B3	Area 19
B4	Area 20

■ Addresses

An address is appended to each variable type. Express addresses in 2-byte hexadecimal and append them for the specified access size.

■ Number of Elements

The number of elements is expressed in 2-byte hexadecimal. Specify the number of elements between 0 and 10. For example, when the number of elements is 000A, it specifies ten items of data from address 0000.

■ List of Services

MRC	SRC	Service name	Description
01	01	Read from Variable Area	Reads from the variable area.
01	02	Write to Variable Area	Writes the variable area.
05	03	Controller Attribute Read	Reads the model and communications buffer size.
06	01	Controller Status Read	Reads the operating status.
07	01	Time Data Read	Reads the time data.
07	02	Time Data Write	Writes the time data.
08	01	Echoback Test	Performs an echoback test.
30	05	Operation Command	Changes the operating mode or changes the protection level.

6.3 Service Details

■ Read from Variable Area

This service reads data from a variable area.

• Service Request PDU

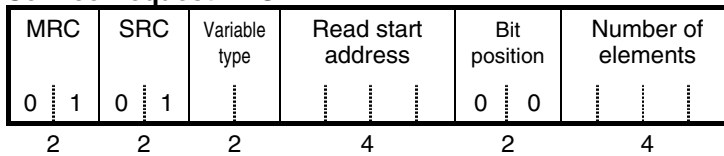

• Service Response PDU

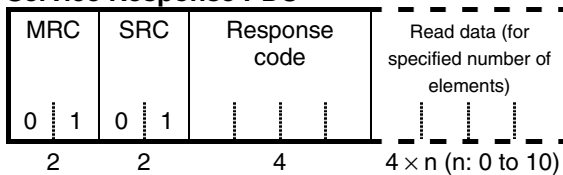

- (1) Variable Type and Read Start Address
For details on variable types and read start addresses, refer the list of setting ranges for the variable area in *Section 7 Communications Data for CompoWay/F.* (page 7-2)
- (2) Bit Position
The K7L-UP-FLK does not support bit access. The setting is always 00.
- (3) Number of Elements

Number of elements	Description
0000	The read operation is not performed (read data is not appended to the service response PDU), and processing ends normally.
0001 to 0010	The read operation is performed, and processing ends normally.

- (4) Response Code

Normal End

Response code	Name	Description
0000	Normal end	No errors were found.

Error End

Response code	Error name	Description
0401	Unsupported command	The service function for the relevant command is not supported.
1001	Command length too long	The command is too long.
1002	Command length too short	The command is too short.
1101	Area type error	The variable type is incorrect.
1103	Start address out-of-range error	The read start address is out of range.
1104	End address out-of-range error	The end address is out of range.
110B	Response length too long	The response length exceeds the communications buffer length.
1100	Parameter error	Specified bit position is not 00.
2203	Operation error	Applicable if the command is not received in the possible communications range.

■ **Write to Variable Area**

This service writes data to a variable area.

• **Service Request PDU**

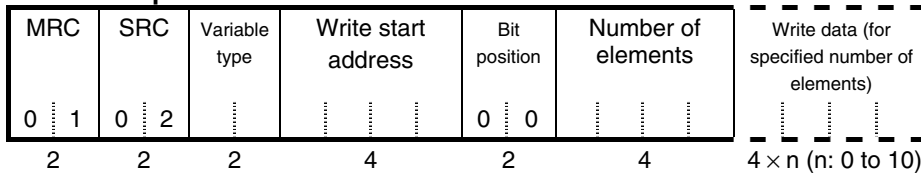

• **Service Response PDU**

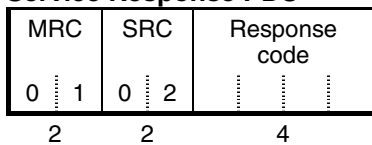

(1) Variable Type and Write Start Address

For details on variable types and read start addresses, refer the list of setting ranges for the variable area in *Section 7 Communications Data for CompoWay/F.* (page 7-2)

(2) Bit Position

The K7L-UP-FLK does not support bit access. The setting is always 00.

(3) Number of Elements

Number of elements	Description
0000	The write operation is not performed (read data is not appended to the service response PDU), and processing ends normally.
0001 to 0010	The write operation is performed, and processing ends normally.

(4) Response Code

Normal End

Response code	Name	Description
0000	Normal end	No errors were found.

Error End

Response code	Error name	Description
0401	Unsupported command	The service function for the relevant command is not supported.
1002	Command length too short	The command is too short.
1101	Area type error	The variable type is incorrect.
1103	Start address out-of-range error	The write start address is out of range.
1104	End address out-of-range error	The write end address exceeds the final address of the variable area.
1003	Number of elements/data mismatch	The number of data does not match the number of elements.
1100	Parameter error	Specified bit position is not "00." The write data is out of the setting range.
2203	Operation error	Applicable if the command is not received is the possible communications range. Applicable if an attempt was made to write to a read-only address.

■ Controller Attribute Read

This service reads the model and communications buffer size.

• Service Request PDU

MRC	SRC
0 5	0 3
2	2

• Service Response PDU

MRC	SRC	Response code	Format	Buffer size
0 5	0 3	0 0 9 8
2	2	4	10	4

(1) Model

The model number is expressed in 10-byte ASCII.

K	7	L	-	U	P	-	F	L	K
---	---	---	---	---	---	---	---	---	---

(2) Buffer Size

The communications buffer size in the K7L-UP-FLK is expressed in 2-byte hexadecimal, and read after being converted to 4-byte ASCII. Buffer size: 152 bytes: (= 0098 hex).

(3) Response Code

Normal End

Response code	Name	Description
0000	Normal end	No errors were found.

Error End

Response code	Name	Description
1001	Command length too long	The command is too long.

■ Controller Status Read

This service reads the operating status and error status.

• Service Request PDU

MRC	SRC
0 6	0 1
2	2

• Service Response PDU

MRC	SRC	Response code	Operating status	Related information
0 6	0 1			
2	2	4	2	2

(1) Operating Status

Operating status	Description
00	Monitoring (No event or error occurred.)
01	Monitoring (Event or error occurred.)
02	Other than the above

(2) Related Information

Bit position	Description	Present status
0	Leak (LEAK)	
1	Second leak (2nd-LEAK)	
2	Leak spreading (Ex-LEAK)	
3	Disconnection (BREAK CABLE)	
4	RTC error (RTCERR)	
5	Wiring error	
6	Not used.	
7	Not used.	

Note: For details, refer to 7.2 Status.

(3) Response Code

Normal End

Response code	Name	Description
0000	Normal end	No errors were found.

Error End

Response code	Error name	Description
0401	Unsupported command	The service function for the relevant command is not supported.
1001	Command length too long	The command is too long.

■ Time Data Read

This service reads the time data.

- **Service Request PDU**

MRC	SRC
0 7	0 1
2	2

- **Service Response PDU**

MRC	SRC	Response code	Year	Month	Day	Hour	Minutes	Seconds
0 7	0 1
2	2	4	2	2	2	2	2	2

Note: Time data (from years to seconds) are treated as decimals.

(1) Response Code

Normal End

Response code	Name	Description
0000	Normal end	No errors were found.

Error End

Response code	Error name	Description
0401	Unsupported command	The service function for the relevant command is not supported.
1001	Command length too long	The command is too long.

■ Time Data Write

This service writes the time data.

• Service Request PDU

MRC	SRC	Year	Month	Day	Hour	Minutes
0 7	0 2
2	2	2	2	2	2	2

• Service Response PDU

MRC	SRC	Response code
0 7	0 2
2	2	4

Note: Time data (from years to seconds) are treated as decimals.

(1) Response Code

Normal End

Response code	Name	Description
0000	Normal end	No errors were found.

Error End

Response code	Error name	Description
0401	Unsupported command	The service function for the relevant command is not supported.
1001	Command length too long	The command is too long.
1002	Command length too short	The command is too short.
1100	Parameter error	The time information is incorrect.
2203	Operation error	Applicable if the command is not received in the possible communications range.

■ Echoback Test

This service performs an echoback test.

• Service Request PDU

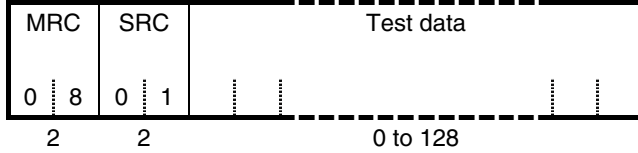

• Service Response PDU

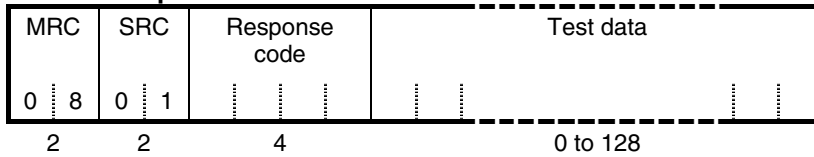

- (1) Test Data
Set any test data with the range of 0 to 128.
- (2) Response Code

Normal End

Response code	Name	Description
0000	Normal end	No errors were found.

Error End

Response code	Error name	Description
0401	Unsupported command	The service function for the relevant command is not supported.
1001	Command length too long	The command is too long.

■ Operation Commands

This service sets the operation level, initializes settings, performs resets, clears the event logs, changes the protection level, and clears the area settings.

• Service Request PDU

MRC	SRC	Operation code	Related information
3 0	0 5
2	2	2	2

• Service Response PDU

MRC	SRC	Response code
3 0	0 5
2	2	4

(1) Operation Codes and Related Information

Operation code	Description	Related information
01	Operation Level Setting	00: Monitor Mode 01: Setting Mode 02: Protection Mode
02	Parameter Initialization	Always 00.
03	Reset	Always 00.
04	Change Protection Level	00: Level 0 01: Level 1 02: Level 2
05	Clear Area	01: Area 1 02: Area 2 03: Area 3 04: Area 4 05: Area 5 06: Area 6 07: Area 7 08: Area 8 09: Area 9 0A: Area 10 0B: Area 11 0C: Area 12 0D: Area 13 0E: Area 14 0F: Area 15 10: Area 16 11: Area 17 12: Area 18 13: Area 19 14: Area 20

(2) Response Code

Normal End

Response code	Name	Description
0000	Normal end	No errors were found.

Error End

Response code	Error name	Description
0401	Unsupported command	The service function for the relevant command is not supported.
1001	Command length too long	The command is too long.
1002	Command length too short	The command is too short.
1100	Parameter error	The command code and related information are incorrect.
2203	Operation error	Processing could not be performed.

(3) Description of Operation Commands and Precautions

- **Operation Level Setting**

Switches the system to Monitor Mode, Setting Mode, or Protection Mode. An operation error will occur if operation level setting is executed when there is a leak.

- **Parameter Initialization**

Parameter initialization returns the present settings to the default values. It can be executed only in Setting Mode. An operation error will occur if parameter initialization is executed in Monitor Mode.

When parameter initialization has been completed normally, there will be no response.

Note: The communications parameters will also be initialized. Reset these parameters as required.

- **Reset**

Resets the system from liquid leakage, disconnection, or error status.

- **Change Protection Level**

Changes the protection level. Change Protection Level can be executed only in Protection Mode.

- **Clear Area**

Clears the specified area. An operation error will occur if this command is executed when an area is not set even if the area is enabled. An operation error will also occur if there are area settings but the area is not enabled.

Note: Refer to *7.3 Possible Communications Range* to see if the command can be executed in each status.

6.4 List of Response Codes

Normal End

Response code	Name	Description	Error detection priority
0000	Normal end	No errors were found.	None

Error End

Response code	Name	Description	Error detection priority
0401	Unsupported command	The service function for the relevant command is not supported.	1
1001	Command length too long	The command is too long.	2
1002	Command length too short	The command is too short.	3
1101	Area type error	The variable type is incorrect.	4
1103	Start address out-of-range error	The read/write start address is out of range.	5
1104	End address out-of-range error	The write end address exceeds the last address of the variable area.	6
1003	Number of elements/data mismatch	The number of data does not match the number of elements.	7
110B	Response length too long	The response length exceeds the communications buffer size.	8
1100	Parameter error	The bit position is not "00." The write data is out of the setting range. The command code and related information in the operation command are incorrect. The time information is incorrect.	9
2203	Operation error	Operation is not possible for an operation command. The command was not received in the possible communications range.	8

Section 7 Communications Data for CompoWay/F Protocol

This section describes the communications data format used with the CompoWay/F protocol.

7.1	Variable Area Parameters and Setting/Monitor Ranges.....	7-2
7.2	Status.....	7-8
7.3	Possible Communications Range.....	7-9

7.1 Variable Area Parameters and Setting/Monitor Ranges

The following table lists the parameters in the variable area. Items expressed in hexadecimal in the *Setting/monitor value* column are the setting range in the CompoWay/F specifications. Values in parentheses are the actual setting ranges. Read-only parameters are shaded.

Item	Variable type	Address	Parameter name	Setting/monitor value
Event Information	80	0000	Cable Length	0000 to 02BB hex: 0 to 699 m 270F hex: Disconnection or cable length error
		0001	Status	0001 hex: Leak (LEAK) 0002 hex: Second leak (2nd-LEAK) 0003 hex: Leak spreading (Ex-LEAK) 0004 hex: Disconnection (BREAK CABLE) 270F hex: No event
		0002	Leak Position	0000 to 02BB hex: 0 to 699 m 270F hex: No leak
		0003	Leak Area	0001 to 0014 hex: 1 to 20 0000 hex: Not set 270F hex: No leak
		0004	Number of Areas	0001 to 0014 hex: 1 to 20 0000 hex: Not set
		0005	Change in Leak Position (See note 1.)	0000 to 02BB hex: 0 to 699 m 270F hex: No leak
Operation Settings	81	0000	Sensitivity	0000 hex: 50 k Ω 0001 hex: 100 k Ω
		0001	Output Setting	0000 hex: NO (normally open) 0001 hex: NC (normally closed)
		0002	Backlight	0000 hex: 2 minutes 0001 hex: 10 minutes 0002 hex: 30 minutes 0003 hex: Always ON
		0003	Reset Setting	0000 hex: Automatic 0001 hex: Manual 1 0002 hex: Manual 2
		0004	Language	0000 hex: Japanese 0001 hex: English
		0005	Zero Shift Setting (See note 2.)	FF9C to 0000 hex: -100 to 0 m 270F hex: Invalid
		0006	Short Position with Zero Shift (See note 3.)	0000 to 02BB hex: 0 to 699 m 270F hex: No short
		0007	Correction Setting (See note 2.)	FF9C to 0064 hex: -100 to 100 m 270F hex: Invalid
		0008	Zero Shift Setting	0000 hex: Invalid 0001 hex: Valid
		0009	Correction Setting	0000 hex: Invalid 0001 hex: Valid
		000A	Area Setting	0000 hex: Invalid 0001 hex: Valid
		000B	4 to 20 mA	0001 to 02BB hex: 1 to 699 m
		000C	Short Position with 4 to 20 mA (See note 3.)	0000 to 02BB hex: 0 to 699 m 270F hex: No short

- Note: 1. The Change in Leak Position parameter provides a guide for the location of the second leak point when a leak spreads. For details, refer to *3.3 Procedures When Problems Are Detected*.
2. Changes in this setting require 45 s before they are applied.
3. The short-circuit position can be read only during a short.

Item	Variable type	Address	Parameter name	Setting/monitor values
Event Log 1	83	0000	Event	0000 hex: No 0001 hex: Yes
		0001	Year	07D0 to 0833 hex: 2000 to 2099 270F hex: No event
		0002	Month and Day	01 to 0C hex: January to December 01 to 1F hex: 1 to 31 270F hex: No event
		0003	Hours and Minutes	00 to 17 hex: 0 to 23 00 to 3B hex: 0 to 59 270F hex: No event
		0004	Type of Event	0001 hex: Leak (LEAK) 0002 hex: Second leak (2nd-LEAK) 0003 hex: Leak spreading (Ex-LEAK) 0004 hex: Disconnection (BREAK CABLE) 0005 hex: RTC ERROR (RTCERR) 270F hex: No event
		0005	Leak Position	0000 to 02BB hex: 0 to 699 m 270F hex: No
		0006	Leak Area	0001 to 0014 hex: 1 to 20 (leak area) 0000 hex: Not set 270F hex: No leak
Event Log 2	84	Same as for event log 1.		
Event Log 3	85			
Event Log 4	86			
Event Log 5	87			
Event Log 6	88			
Event Log 7	89			
Event Log 8	8A			
Event Log 9	8B			
Event Log 10	8C			
Event Log 11	8D			
Event Log 12	8E			
Event Log 13	8F			
Event Log 14	90			
Event Log 15	91			
Event Log 16	92			
Event Log 17	93			
Event Log 18	94			
Event Log 19	95			
Event Log 20	96			

Item	Variable type	Address	Parameter name	Setting/monitor values	
Area 1	A1	0000	Area 1 Name, 1	Characters 1 and 2:	Refer to character code table.
		0001	Area 1 Name, 2	Characters 3 and 4:	Refer to character code table.
		0002	Area 1 Name, 3	Characters 5 and 6:	Refer to character code table.
		0003	Area 1 Name, 4	Characters 7 and 8:	Refer to character code table.
		0004	Area 1 Start Distance	0000 hex:	0 m
		0005	Area 1 End Distance	0001 to 02BB hex:	1 m to 699 m
		0006	Short Position with Area	0000 to 02BB hex: 270F hex:	0 m to 699 m No short
Area 2	A2	0000	Area 2 Name, 1	Characters 1 and 2:	Refer to character code table.
		0001	Area 2 Name, 2	Characters 3 and 4:	Refer to character code table.
		0002	Area 2 Name, 3	Characters 5 and 6:	Refer to character code table.
		0003	Area 2 Name, 4	Characters 7 and 8:	Refer to character code table.
		0004	Area 2 Start Distance	0002 to 02BA hex:	2 m to 698 m
		0005	Area 2 End Distance	0003 to 02BB hex:	3 m to 699 m
		0006	Short Position with Area	0000 to 02BB hex: 270F hex:	0 m to 699 m No short
Area 3	A3	0000	Area 3 Name, 1	Characters 1 and 2:	Refer to character code table.
		0001	Area 3 Name, 2	Characters 3 and 4:	Refer to character code table.
		0002	Area 3 Name, 3	Characters 5 and 6:	Refer to character code table.
		0003	Area 3 Name, 4	Characters 7 and 8:	Refer to character code table.
		0004	Area 3 Start Distance	0003 to 02BA hex:	3 m to 698 m
		0005	Area 3 End Distance	0004 to 02BB hex:	4 m to 699 m
		0006	Short Position with Area	0000 to 02BB hex: 270F hex:	0 m to 699 m No short
Area 4	A4	0000	Area 4 Name, 1	Characters 1 and 2:	Refer to character code table.
		0001	Area 4 Name, 2	Characters 3 and 4:	Refer to character code table.
		0002	Area 4 Name, 3	Characters 5 and 6:	Refer to character code table.
		0003	Area 4 Name, 4	Characters 7 and 8:	Refer to character code table.
		0004	Area 4 Start Distance	0004 to 02BA hex:	4 m to 698 m
		0005	Area 4 End Distance	0005 to 02BB hex:	5 m to 699 m
		0006	Short Position with Area	0000 to 02BB hex: 270F hex:	0 m to 699 m No short
Area 5	A5	0000	Area 5 Name, 1	Characters 1 and 2:	Refer to character code table.
		0001	Area 5 Name, 2	Characters 3 and 4:	Refer to character code table.
		0002	Area 5 Name, 3	Characters 5 and 6:	Refer to character code table.
		0003	Area 5 Name, 4	Characters 7 and 8:	Refer to character code table.
		0004	Area 5 Start Distance	0005 to 02BA hex:	5 m to 698 m
		0005	Area 5 End Distance	0006 to 02BB hex:	6 m to 699 m
		0006	Short Position with Area	0000 to 02BB hex: 270F hex:	0 m to 699 m No short
Area 6	A6	0000	Area 6 Name, 1	Characters 1 and 2:	Refer to character code table.
		0001	Area 6 Name, 2	Characters 3 and 4:	Refer to character code table.
		0002	Area 6 Name, 3	Characters 5 and 6:	Refer to character code table.
		0003	Area 6 Name, 4	Characters 7 and 8:	Refer to character code table.
		0004	Area 6 Start Distance	0006 to 02BA hex:	6 m to 698 m
		0005	Area 6 End Distance	0007 to 02BB hex:	7 m to 699 m
		0006	Short Position with Area	0000 to 02BB hex: 270F hex:	0 m to 699 m No short

7.1 Variable Area Parameters and Setting/Monitor Ranges

Item	Variable type	Address	Parameter name	Setting/monitor values	
Area 7	A7	0000	Area 7 Name, 1	Characters 1 and 2:	Refer to character code table.
		0001	Area 7 Name, 2	Characters 3 and 4:	Refer to character code table.
		0002	Area 7 Name, 3	Characters 5 and 6:	Refer to character code table.
		0003	Area 7 Name, 4	Characters 7 and 8:	Refer to character code table.
		0004	Area 7 Start Distance	0007 to 02BA hex:	7 m to 698 m
		0005	Area 7 End Distance	0008 to 02BB hex:	8 m to 699 m
		0006	Short Position with Area	0000 to 02BB hex: 270F hex:	0 m to 699 m No short
Area 8	A8	0000	Area 8 Name, 1	Characters 1 and 2:	Refer to character code table.
		0001	Area 8 Name, 2	Characters 3 and 4:	Refer to character code table.
		0002	Area 8 Name, 3	Characters 5 and 6:	Refer to character code table.
		0003	Area 8 Name, 4	Characters 7 and 8:	Refer to character code table.
		0004	Area 8 Start Distance	0008 to 02BA hex:	8 m to 698 m
		0005	Area 8 End Distance	0009 to 02BB hex:	9 m to 699 m
		0006	Short Position with Area	0000 to 02BB hex: 270F hex:	0 m to 699 m No short
Area 9	A9	0000	Area 9 Name, 1	Characters 1 and 2:	Refer to character code table.
		0001	Area 9 Name, 2	Characters 3 and 4:	Refer to character code table.
		0002	Area 9 Name, 3	Characters 5 and 6:	Refer to character code table.
		0003	Area 9 Name, 4	Characters 7 and 8:	Refer to character code table.
		0004	Area 9 Start Distance	0009 to 02BA hex:	9 m to 698 m
		0005	Area 9 End Distance	000A to 02BB hex:	10 m to 699 m
		0006	Short Position with Area	0000 to 02BB hex: 270F hex:	0 m to 699 m No short
Area 10	AA	0000	Area 10 Name, 1	Characters 1 and 2:	Refer to character code table.
		0001	Area 10 Name, 2	Characters 3 and 4:	Refer to character code table.
		0002	Area 10 Name, 3	Characters 5 and 6:	Refer to character code table.
		0003	Area 10 Name, 4	Characters 7 and 8:	Refer to character code table.
		0004	Area 10 Start Distance	000A to 02BA hex:	10 m to 698 m
		0005	Area 10 End Distance	000B to 02BB hex:	11 m to 699 m
		0006	Short Position with Area	0000 to 02BB hex: 270F hex:	0 m to 699 m No short
Area 11	AB	0000	Area 11 Name, 1	Characters 1 and 2:	Refer to character code table.
		0001	Area 11 Name, 2	Characters 3 and 4:	Refer to character code table.
		0002	Area 11 Name, 3	Characters 5 and 6:	Refer to character code table.
		0003	Area 11 Name, 4	Characters 7 and 8:	Refer to character code table.
		0004	Area 11 Start Distance	000B to 02BA hex:	11 m to 698 m
		0005	Area 11 End Distance	000C to 02BB hex:	12 m to 699 m
		0006	Short Position with Area	0000 to 02BB hex: 270F hex:	0 m to 699 m No short
Area 12	AC	0000	Area 12 Name, 1	Characters 1 and 2:	Refer to character code table.
		0001	Area 12 Name, 2	Characters 3 and 4:	Refer to character code table.
		0002	Area 12 Name, 3	Characters 5 and 6:	Refer to character code table.
		0003	Area 12 Name, 4	Characters 7 and 8:	Refer to character code table.
		0004	Area 12 Start Distance	000C to 02BA hex:	12 m to 698 m
		0005	Area 12 End Distance	000D to 02BB hex:	13 m to 699 m
		0006	Short Position with Area	0000 to 02BB hex: 270F hex:	0 m to 699 m No short

Item	Variable type	Address	Parameter name	Setting/monitor values
Area 13	AD	0000	Area 13 Name, 1	Characters 1 and 2: Refer to character code table.
		0001	Area 13 Name, 2	Characters 3 and 4: Refer to character code table.
		0002	Area 13 Name, 3	Characters 5 and 6: Refer to character code table.
		0003	Area 13 Name, 4	Characters 7 and 8: Refer to character code table.
		0004	Area 13 Start Distance	000D to 02BA hex: 13 m to 698 m
		0005	Area 13 End Distance	000E to 02BB hex: 14 m to 699 m
		0006	Short Position with Area	0000 to 02BB hex: 0 m to 699 m 270F hex: No short
Area 14	AE	0000	Area 14 Name, 1	Characters 1 and 2: Refer to character code table.
		0001	Area 14 Name, 2	Characters 3 and 4: Refer to character code table.
		0002	Area 14 Name, 3	Characters 5 and 6: Refer to character code table.
		0003	Area 14 Name, 4	Characters 7 and 8: Refer to character code table.
		0004	Area 14 Start Distance	000E to 02BA hex: 14 m to 698 m
		0005	Area 14 End Distance	000F to 02BB hex: 15 m to 699 m
		0006	Short Position with Area	0000 to 02BB hex: 0 m to 699 m 270F hex: No short
Area 15	AF	0000	Area 15 Name, 1	Characters 1 and 2: Refer to character code table.
		0001	Area 15 Name, 2	Characters 3 and 4: Refer to character code table.
		0002	Area 15 Name, 3	Characters 5 and 6: Refer to character code table.
		0003	Area 15 Name, 4	Characters 7 and 8: Refer to character code table.
		0004	Area 15 Start Distance	000F to 02BA hex: 15 m to 698 m
		0005	Area 15 End Distance	0010 to 02BB hex: 16 m to 699 m
		0006	Short Position with Area	0000 to 02BB hex: 0 m to 699 m 270F hex: No short
Area 16	B0	0000	Area 16 Name, 1	Characters 1 and 2: Refer to character code table.
		0001	Area 16 Name, 2	Characters 3 and 4: Refer to character code table.
		0002	Area 16 Name, 3	Characters 5 and 6: Refer to character code table.
		0003	Area 16 Name, 4	Characters 7 and 8: Refer to character code table.
		0004	Area 16 Start Distance	0010 to 02BA hex: 16 m to 698 m
		0005	Area 16 End Distance	0011 to 02BB hex: 17 m to 699 m
		0006	Short Position with Area	0000 to 02BB hex: 0 m to 699 m 270F hex: No short
Area 17	B1	0000	Area 17 Name, 1	Characters 1 and 2: Refer to character code table.
		0001	Area 17 Name, 2	Characters 3 and 4: Refer to character code table.
		0002	Area 17 Name, 3	Characters 5 and 6: Refer to character code table.
		0003	Area 17 Name, 4	Characters 7 and 8: Refer to character code table.
		0004	Area 17 Start Distance	0011 to 02BA hex: 17 m to 698 m
		0005	Area 17 End Distance	0012 to 02BB hex: 18 m to 699 m
		0006	Short Position with Area	0000 to 02BB hex: 0 m to 699 m 270F hex: No short
Area 18	B2	0000	Area 18 Name, 1	Characters 1 and 2: Refer to character code table.
		0001	Area 18 Name, 2	Characters 3 and 4: Refer to character code table.
		0002	Area 18 Name, 3	Characters 5 and 6: Refer to character code table.
		0003	Area 18 Name, 4	Characters 7 and 8: Refer to character code table.
		0004	Area 18 Start Distance	0012 to 02BA hex: 18 m to 698 m
		0005	Area 18 End Distance	0013 to 02BB hex: 19 m to 699 m
		0006	Short Position with Area	0000 to 02BB hex: 0 m to 699 m 270F hex: No short

Item	Variable type	Address	Parameter name	Setting/monitor values
Area 19	B3	0000	Area 19 Name, 1	Characters 1 and 2: Refer to character code table.
		0001	Area 19 Name, 2	Characters 3 and 4: Refer to character code table.
		0002	Area 19 Name, 3	Characters 5 and 6: Refer to character code table.
		0003	Area 19 Name, 4	Characters 7 and 8: Refer to character code table.
		0004	Area 19 Start Distance	0013 to 02BA hex: 19 m to 698 m
		0005	Area 19 End Distance	0014 to 02BB hex: 20 m to 699 m
		0006	Short Position with Area	0000 to 02BB hex: 0 m to 699 m 270F hex: No short
Area 20	B4	0000	Area 20 Name, 1	Characters 1 and 2: Refer to character code table.
		0001	Area 20 Name, 2	Characters 3 and 4: Refer to character code table.
		0002	Area 20 Name, 3	Characters 5 and 6: Refer to character code table.
		0003	Area 20 Name, 4	Characters 7 and 8: Refer to character code table.
		0004	Area 20 Start Distance	0014 to 02BA hex: 20 m to 698 m
		0005	Area 20 End Distance	02BB hex: 699 m
		0006	Short Position with Area	0000 to 02BB hex: 0 m to 699 m 270F hex: No short

- Note: 1. A parameter error will occur if 20 areas have been set and a distance is set that is shorter than the present end distance.
2. The distance cannot be set for area 20.
 3. Short Position with Area can be checked only while areas have been edited.
 4. Refer to the appendix for a table of character codes that can be used.
 5. An operation error will occur if an attempt is made to write or read data when the area settings are disabled. If the area is enabled but the area is not set, an operation error will occur if an attempt is made to write to or read from an address.

7.2 Status

This section describes the status data.

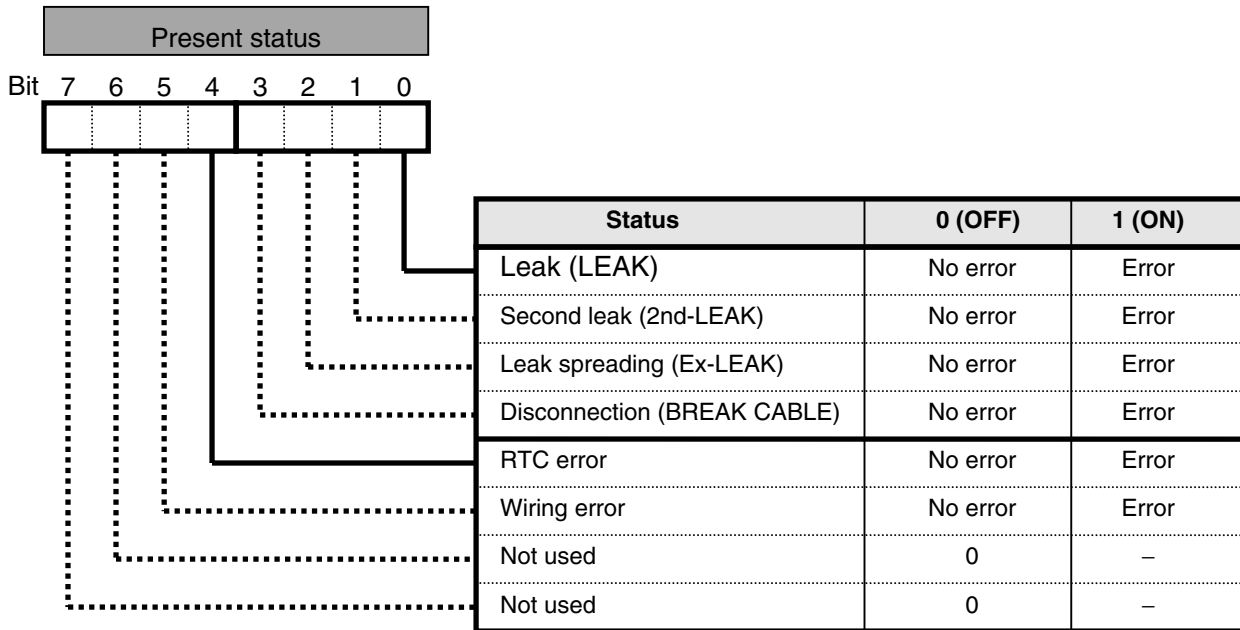

Note: 1. ON (1) will be set when the relevant event occurs.

2. Unused bits are always OFF (0).

The following table gives the status read responses.

Example:

Event/ Error End	Bit status	Response	
		Operating status	Related information
No Event/Error	00000000	00	00
Leak (LEAK)	00000001	01	01
Disconnection (BREAK CABLE)	00001000	01	08
Cable error (CABLE ERR)	00100000	01	20

7.3 Possible Communications Range

The following table gives shows the possible communications ranges.

Status	Variable Area		Controller Attribute Read	Controller Status Read	Time Data Read	Time Data Write	Echoback Test	Operation Commands				
	Read	Write						Operation Level Setting	Parameter Initialization	Reset	Change Protection Level	Clear Area
Monitoring		x				x		x		x	x	
Setting									x	x		
Leak		x				x		x	x	x	x	
Disconnection		x				x		x		x	x	
Protection Mode (See note.)		x				x		x	x		x	
Unit error Turning ON power supply	Communications are not possible in some status.											

x: An error response (operation error) is returned. An operation error will occur if an attempt is made to read or write communications in other status for which communications are prohibited (e.g., performing communications during testing).

Blank: A normal response is returned if a normal command is executed.

Note: Enter Protection Mode by pressing the **ALT + DEL** Keys for 3 s.

Section 8

Modbus Communications Protocol

Read this section before performing communications following the Modbus protocol.

8.1	Data Format.....	8-2
8.2	List of Functions	8-6
8.3	Variable Areas.....	8-7
8.4	Service Details	8-8

8.1 Data Format

Commands from the host computer and responses from the K7L-UP-FLK take the form of frames that conform to the Modbus (RTU) protocol. The data included in command frames and response frames is described in this section.

In the following descriptions, “hex” after a numeric value (for example 02 hex) indicates that the value is a hexadecimal number.

■ Command Frames

In RTU Mode, each frame begins and ends with a silent time interval that is at least 3.5 characters long.

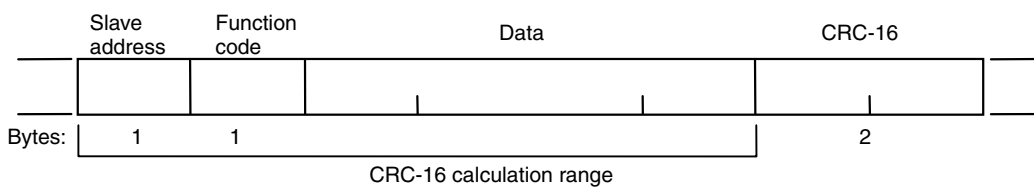

	Silent interval at least 3.5 characters long.
Slave address	Specify the unit number of the K7L-UP-FLK between 00 and 63 hex (0 to 99). When broadcasting to all nodes, specify 00 hex. Responses are not returned for broadcasts.
Function code	The function code specifies the command from the host computer. The code is set in hexadecimal and is 1 byte long
Data	The text of command based on the function code. Specifies variable addresses and the values for set values in hexadecimal.
CRC-16	Cyclical Redundancy Check These two bytes store check code calculated from the slave address to the end of the data in hexadecimal.
	Silent interval at least 3.5 characters long.

Example of CRC-16 Calculation

A message is processed 1 byte at a time in a 16-bit processing register called the CRC register.

- (1) An initial value of FFFF hex is set in the CRC register.
- (2) An XOR is taken of the contents of the CRC register and the 1st byte of the message, and the result is returned to the CRC register.
- (3) The contents of the CRC register is shifted 1 bit to the right, and 0 is placed in the MSB.
- (4) If the bit shifted from the LSB is 0, step 3 is repeated.
If the bit shifted from the LSB is 1, an XOR is taken of the contents of the CRC register and A001 hex, and the result is returned to the CRC register.
- (5) Steps 3 and 4 are repeated until the contents of the register have been shifted 8 bits to the right.
- (6) If the end of the message has not been reached, an XOR is taken of the next byte of the CRC register and the message, the result is returned to the CRC register, and the procedure is repeated from step (3).
- (7) The result (the value in the CRC register) is placed in the lower byte of the message.

• Example of Appending the Result

If the calculated CRC value is 1234 hex, this value is appended as follows to the command frame:

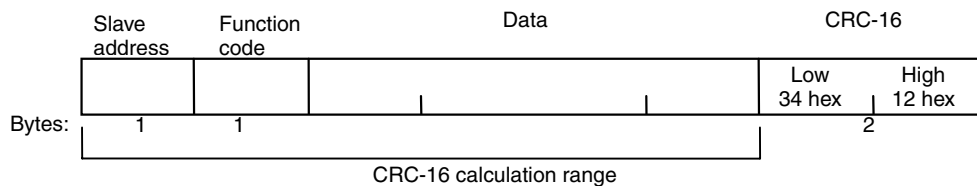

■ Response Frames

• Normal Response Frames

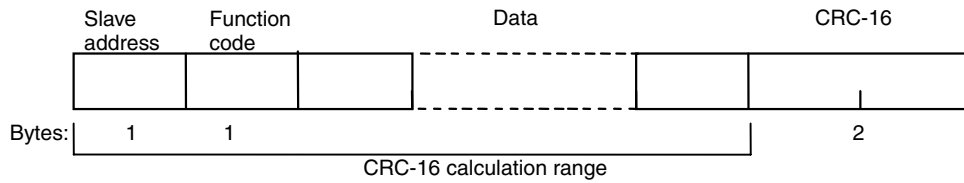

• Error Response Frames

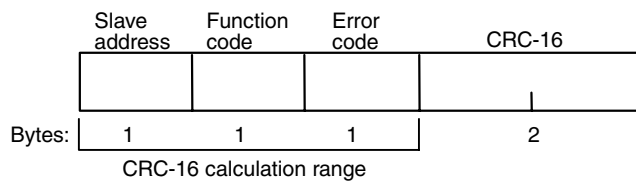

Slave address	The unit number that was specified in the command frame is returned here. This is the unit number of the responding K7L-UP-FLK.
Function code	The function code that was received is returned here. In an error response frame, "80 hex" is added to the value to indicate that this is an error response. Example: Received function code = 03 hex Function code in error response frame = 83 hex
Error code	An end code that indicates the error.
CRC-16	Cyclical Redundancy Check These two bytes are a check code calculated from the slave address through the end of the data in hexadecimal.

■ Error Codes

End code	Name	Description	Error detection priority
01 hex	Function code error	Received an unsupported function code.	1
02 hex	Variable address error	The variable area number specified in the variable address is out of range.	2
03 hex	Variable data error	The number of elements does not agree with the number of data items. Number of elements times 2 does not agree with the byte count. The response length exceeds the communications buffer size. The operation code or related information in an operation command is not correct. The written data exceeds the setting range.	3
04 hex	Operation error	The setting in the write data is not permitted in the current operating mode. The communications writing function is disabled.	4

• No Response

In the following cases, the received command is not processed and a response is not returned. A timeout will occur at the host device.

- The slave address in the received command is different from the communications unit number set in the K7L-UP-FLK.
 - A parity error, framing error, or overrun error occurred due to a transfer error or other error.
 - A CRC-16 code error occurred in the received command frame.
 - A time interval greater than 3.5 characters occurred between data while receiving a command frame.

In the following case, the specified processing will be executed (for applicable functions), but no responses will be returned.

- Broadcast transmissions (slave address: 00 hex)

8.2 List of Functions

The function codes are listed below.

Function Codes

Function codes	Name	Description
03 (03 hex)	Multiple Read from Variable Area	Reads a variable area. Multiple variables that are consecutive can be read.
16 (10 hex)	Multiple Write to Variable Area	Writes to a variable area. Multiple variables that are consecutive can be written. Broadcasting is possible.
06 (06 hex)	Operation Command	Writes an operation command. Broadcasting is possible.
08 (08 hex)	Echoback Test	Performs an echoback test.

8.3 Variable Areas

The areas used for data exchange when communicating with the K7L-UP-FLK are called the variable areas. Present values can be read, and set values can be read and written using the variable areas.

Operation commands do not use the variable areas.

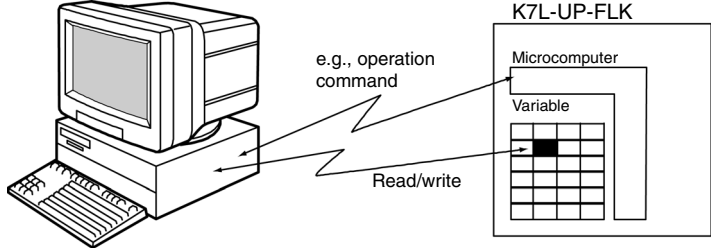

A variable area is accessed by specifying the position of a variable within the variable area using the channel identifier, area number, and address in the area.

- Addresses**

Addresses are allocated within each variable type. Addresses are two bytes long and written in hexadecimal. Addresses are allocated according to access size. Each address consists of a channel identifier, area number, and the address in the area.

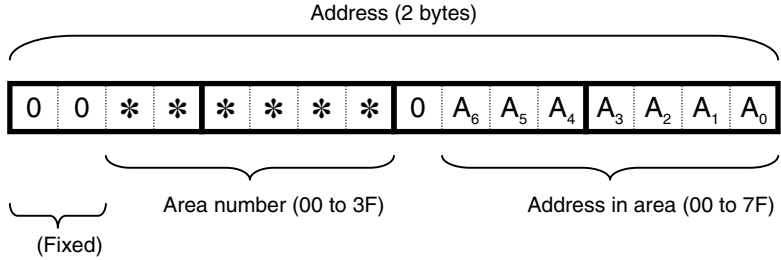

- Number of Elements**

The number of elements is expressed as a 2-byte hexadecimal number. The specification range for the number of elements depends on the command.

8.4 Service Details

■ Multiple Read from Variable Area

Read from a variable area by setting the required data in the following command frame.

• Command Frame

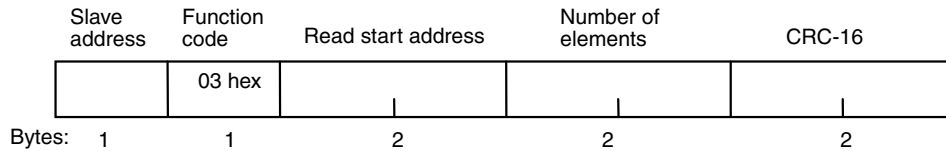

Data name	Description
Slave address	Specify the unit number of the K7L-UP-FLK. Set in hexadecimal between 01 and 63 hex (1 to 99).
Function code	The function code for Read from Variable Area command is 03 hex.
Read start address	Specify the number of setting data items to read. For more information on addresses, refer to <i>9.1 Variable Area Parameters and Setting/Monitor Ranges</i>
Number of elements	Specify the number of parameters to read. Set between 0 and 7.
CRC-16	The check code calculated based on the values from the slave address through the end of the data. For the calculation method, refer to <i>Example of CRC-16 Calculation in 8.1 Data Format</i> .

• **Response Frame**

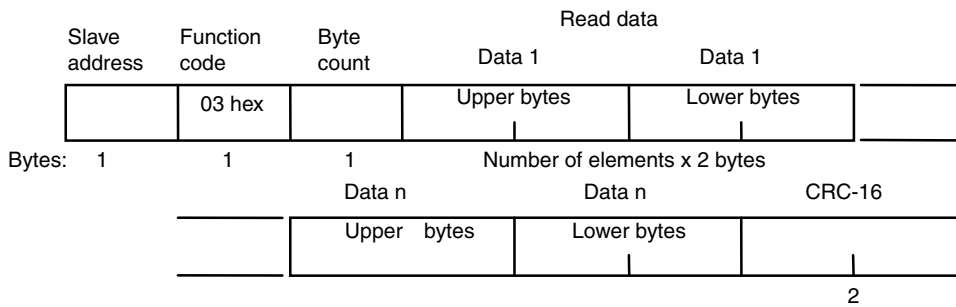

Data name	Description
Slave address	The value from the command frame is returned here.
Function code	The function code that was received. In an error response frame, 80 hex is added to the received function code to indicate that it is an error response. Example: Received function code = 03 hex Function code in error response frame = 83 hex
Byte count	The number of bytes of the read data.
Number of elements	The number of parameters that was read.
CRC-16	This is the check code calculated from the slave address through the end of the data. For the calculation method, refer to <i>Example of CRC-16 Calculation</i> in 8.1 Data Format

• **Response Codes**

Function code	Error code	Error name	Cause
83 hex	02 hex	Variable address error	The variable area number is incorrect. The address in the variable area is out of range.
	03 hex	Variable data error	The number of elements exceeds the specified range. Set between 0 and 7.
	04 hex	Operation error	The command was not accepted because conditions that are required for communications were not met.
03 hex	–	Normal end	No error.

• **Command/Response Example**

The following shows an example of reading the cable length (slave address: 01 hex).

Address: 0000 hex, Data read: 001E hex, Cable length: 30 m

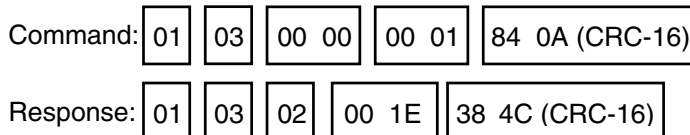

Multiple Write to Variable Area

Write to a variable area by setting the required data in the following command frame.

Command Frame

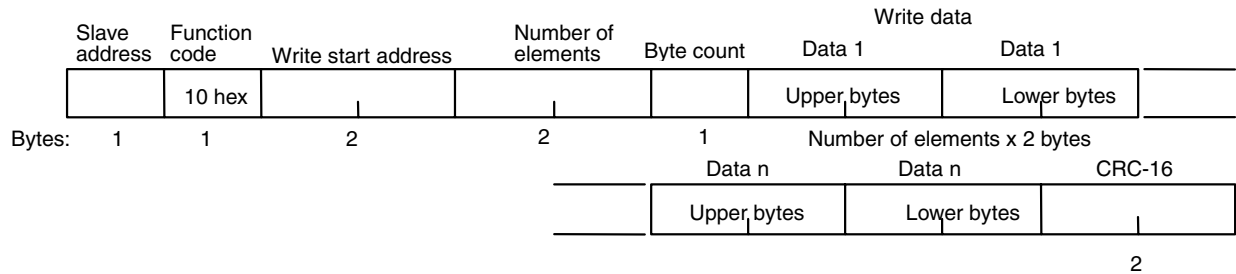

Data name	Description
Slave address	Specify the unit number of the K7L-UP-FLK. Set in hexadecimal between 01 and 63 hex (1 to 99).
Function code	The function code for the Write to Variable Area command is 10 hex.
Write start address	Specify the address of the set value to write. For more information on addresses, refer to <i>9.1 Variable Area Parameters and Setting/Monitor Ranges</i>
Number of elements	Specify the number of setting data items to write. Set between 0 and 7.
Byte count	Specify the number of bytes of data to write.
CRC-16	This is the check code calculated from the slave address through the end of the data. For the calculation method, refer to <i>Example of CRC-16 Calculation in 8.1 Data Format</i> .

• Response Frame

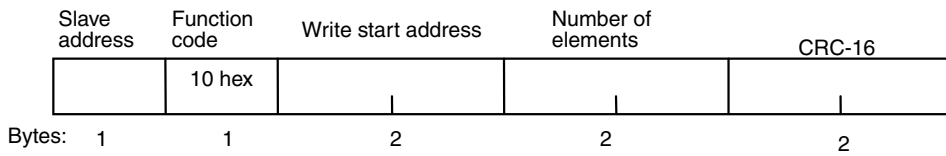

Data name	Description
Slave address	The value from the command frame is returned here.
Function code	The function code that was received. In an error response frame, 80 hex is added to the received function code to indicate that it is an error response. Example: Received function code = 10 hex Function code in error response frame = 90 hex
Write start address	The write start address that was received is returned here.
Number of elements	The received number of elements.
CRC-16	This is the check code calculated from the slave address through the end of the data. For the calculation method, refer to <i>Example of CRC-16 Calculation in 8.1 Data Format</i> .

• Response Code

Function code	Error code	Error name	Cause
90 hex	02 hex	Variable address error	The write start address is incorrect. The variable area number is incorrect. The address in the variable area is out of range.
	03 hex	Variable data error	Number of elements and number of data items do not agree. Number of elements times 2 does not agree with byte count. Write data exceeds the setting range.
	04 hex	Operation error	The operating status does not permit writing. The settings for the write data are not permitted in the current operating mode.
10 hex	–	Normal end	No error

If there are no area settings, an operation error will occur if an attempt is made to write data.

If there are area settings but the area is not enabled, an operation error will occur if an attempt is made to write to the address.

• Command/Response Example

The following example shows writing data when the sensitivity setting is changed to 50 kΩ.

Slave address: 01 hex

Sensitivity: 50 kΩ

Address: 0100 hex, Data written: 0000 hex

Command: 01 10 01 00 00 01 02 00 00 B6 90 (CRC-16)

Response: 01 10 01 00 00 01 00 35 (CRC-16)

■ Operation Commands

Operation commands set the operation level, initialize parameters, perform reset, change the protection level, and clear areas.

• Command Frames

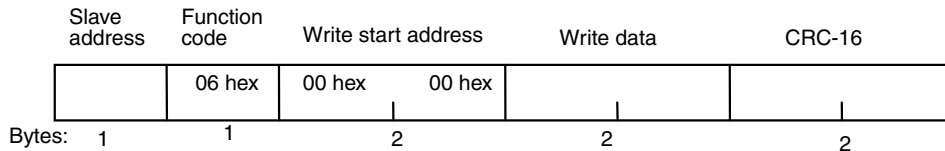

• Response Frames

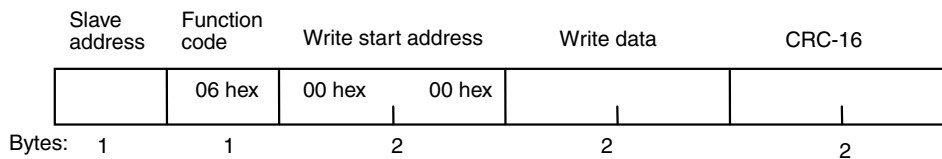

(1) Command Codes and Related Information

Command code	Description	Related information
01	Operation Level Setting	00: Monitor Mode 01: Setting Mode 02: Protection Mode
02	Parameter Initialization	Always 00.
03	Reset	Always 00.
04	Change Protection Level (Can be used only in Protection Mode.)	00: Level 0 01: Level 1 02: Level 2
05	Clear area	01: Area 1 02: Area 2 03: Area 3 04: Area 4 05: Area 5 06: Area 6 07: Area 7 08: Area 8 09: Area 9 0A: Area 10 0B: Area 11 0C: Area 12 0D: Area 13 0E: Area 14 0F: Area 15 10: Area 16 11: Area 17 12: Area 18 13: Area 19 14: Area 20

(2) Response Code

Normal End

Function code	Error code	Error name	Description
06 hex	–	Normal end	No errors were found.

Error End

Function code	Error code	Error name	Description
86 hex	02 hex	Variable address error	The write variable address is not 0000.
	03 hex	Variable data error	The write data is incorrect. The command code or related information is incorrect.
	04 hex	Operation error	The operation status does not permit writing. Applicable if the command is not received in the possible communications range. Processing not possible. For details, refer to (4) <i>Description of Operation Commands and Precautions</i> .

(3) Command and Response Examples

The following examples are for a reset command (when the slave address is 01 hex).

Reset command (reset command: 03, related information: 00)

Address: 0000 hex (fixed)

Write data: 0300 hex (reset command)

Command:

01	06	00 00	03 00	89 3A (CRC-16)
----	----	-------	-------	----------------

Response:

01	06	00 00	03 00	89 3A (CRC-16)
----	----	-------	-------	----------------

(4) Description of Operation Commands and Precautions

- **Operation Level Setting**

Switches the system to Monitor Mode, Setting Mode, or Protection Mode. An operation error will occur if operation level setting is executed when there is a leak.

- **Parameter Initialization**

Parameter initialization returns the present settings to the default values. An operation error will occur if parameter initialization is executed in Monitor Mode.

When parameter initialization has been completed normally, there will be no response.

- **Reset**

Resets the system from liquid leakage, disconnection, or error status.

- **Change Protection level**

Changes the protection level. Change Protection Level can be executed only in Protection Mode.

- **Clear Area**

Clears the specified area. An operation error will occur if this command is executed when an area is not set even if the area is enabled. An operation error will also occur if there are area settings but the area is not enabled.

■ Echoback Test

• Command Frames

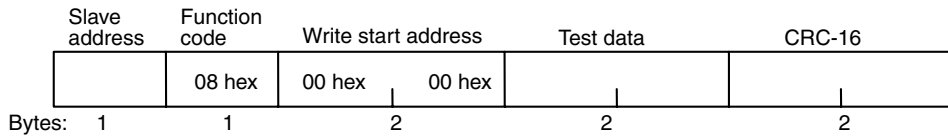

• Response Frames

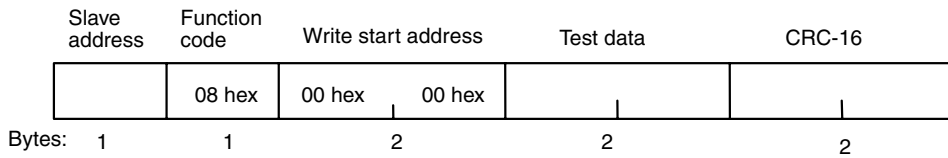

Note: When completion is normal, a response with the same content as the command is returned.

(1) Test Data

The desired data is expressed in 2-byte hexadecimal.

(2) Response Code

Function code	Error code	Name	Description
88 hex	03 hex	Variable data error	The fixed values that follows the function code are not 00 and 00 hex.
08 hex	-	Normal end	No errors were found.

(3) Command and Response Examples

The following examples are for an echoback test (when the test data is 1234 hex and the slave address is 01 hex).

Command:

01	08	00 00	12 34	ED 7C (CRC-16)
----	----	-------	-------	----------------

Response:

01	08	00 00	12 34	ED 7C (CRC-16)
----	----	-------	-------	----------------

Section 9

Communications Data for Modbus Protocol

This section shows the communications data format used in the Modbus protocol.

9.1	Variable Area Parameters and Setting/Monitor Ranges.....	9-2
9.2	Status.....	9-17
9.3	Possible Communications Range.....	9-18

9.1 Variable Area Parameters and Setting/Monitor Ranges

The following table lists the parameters in the variable areas. Items expressed in hexadecimal in the *Setting/monitor values* column are the setting range in the Modbus specifications. Values in parentheses are the actual setting ranges. When there is a section reference for a parameter, refer to that reference for details. The shaded areas are read-only parameters.

Item	Address	Parameter name	Setting/monitor values	
Event Information	0000	Cable Length	0000 to 02BB hex: 270F hex:	0 to 699 m Disconnection or cable length error
	0001	Status	0001 hex: 0002 hex: 0003 hex: 0004 hex: 270F hex:	Leak (LEAK) Second leak (2nd-LEAK) Leak spreading (Ex-LEAK) Disconnection (BREAK CABLE) No event
	0002	Leak Position	0000 to 02BB hex: 270F hex:	0 to 699 m No leak
	0003	Leak Area	0001 to 0014 hex: 0000 hex: 270F hex:	1 to 20 Not set No leak
	0004	Number of Areas	0001 to 0014 hex: 0000 hex:	1 to 20 Not set
	0005	Change in Leak Position (See note 1.)	0000 to 02BB hex: 270F hex:	0 to 699 m No leak
Operation Settings	0100	Sensitivity	0000 hex: 0001 hex:	50 k Ω 100 k Ω
	0101	Output Setting	0000 hex: 0001 hex:	NO (normally open) NC (normally closed)
	0102	Backlight	0000 hex: 0001 hex: 0002 hex: 0003 hex:	2 minutes 10 minutes 30 minutes Always ON
	0103	Reset Setting	0000 hex: 0001 hex: 0002 hex:	Automatic Manual 1 Manual 2
	0104	Language	0000 hex: 0001 hex:	Japanese English
	0105	Zero Shift Setting (See note 2.)	FF9C to 0000 hex: 270F hex:	-100 to 0 m Invalid
	0106	Short Position with Zero Shift (See note 3.)	0000 to 02BB hex: 270F hex:	0 to 699 m No short
	0107	Correction Setting (See note 2.)	FF9C to 0064 hex: 270F hex:	-100 to 100 m Invalid
	0108	Zero Shift Setting	0000 hex: 0001 hex:	Invalid Valid
	0109	Correction Setting	0000 hex: 0001 hex:	Invalid Valid
	010A	Area Setting	0000 hex: 0001 hex:	Invalid Valid
	010B	4 to 20 mA	0001 to 02BB hex:	1 to 699 m
	010C	Short Position with 4 to 20 mA (See note 3.)	0000 to 02BB hex: 270F hex:	0 to 699 m No short

Note: 1. The Change in Leak Position parameter provides a guide for the location of the second leak point when a leak spreads. For details, refer to *3.3 Procedures When Problems Are Detected*.

2. Changes in this setting require 45 s before they are applied.

3. The short-circuit position can be read only during a short.

Item	Address	Parameter name	Setting/monitor values	
Event Log 1	0300	Event	0000 hex: 0001 hex:	No Yes
	0301	Year	07D0 to 0833 hex: 270F hex:	2000 to 2099 No event
	0302	Month and Day	01 to 0C hex: 01 to 1F hex: 270F hex:	January to December 1 to 31 Yes
	0303	Hours and Minutes	00 to 17 hex: 00 to 3B hex: 270F hex:	0 to 23 0 to 59 No event
	0304	Type of Event	0001 hex: 0002 hex: 0003 hex: 0004 hex: 0005 hex: 270F hex:	Leak (LEAK) Second leak (2nd-LEAK) Leak spreading (Ex-LEAK) Disconnection (BREAK CABLE) RTC ERROR (RTCERR) No event
	0305	Leak Position	0000 to 02BB hex: 270F hex:	0 to 699 m No
	0306	Leak Area	0001 to 0014 hex: 0000 hex: 270F hex:	1 to 20 (leak area) Not set No leak
Event Log 2	0400	Event	0000 hex: 0001 hex:	No Yes
	0401	Year	07D0 to 0833 hex: 270F hex:	2000 to 2099 No event
	0402	Month and Day	01 to 0C hex: 01 to 1F hex: 270F hex:	January to December 1 to 31 No event
	0403	Hours and Minutes	00 to 17 hex: 00 to 3B hex: 270F hex:	0 to 23 0 to 59 No event
	0404	Type of Event	0001 hex: 0002 hex: 0003 hex: 0004 hex: 0005 hex: 270F hex:	Leak (LEAK) Second leak (2nd-LEAK) Leak spreading (Ex-LEAK) Disconnection (BREAK CABLE) RTC ERROR (RTCERR) No event
	0405	Leak Position	0000 to 02BB hex: 270F hex:	0 to 699 m No
	0406	Leak Area	0001 to 0014 hex: 0000 hex: 270F hex:	1 to 20 (leak area) Not set No leak

Item	Address	Parameter name	Setting/monitor values	
Event Log 3	0500	Event	0000 hex: 0001 hex:	No Yes
	0501	Year	07D0 to 0833 hex: 270F hex:	2000 to 2099 No event
	0502	Month and Day	01 to 0C hex: 01 to 1F hex: 270F hex:	January to December 1 to 31 No event
	0503	Hours and Minutes	00 to 17 hex: 00 to 3B hex: 270F hex:	0 to 23 0 to 59 No event
	0504	Type of Event	0001 hex: 0002 hex: 0003 hex: 0004 hex: 0005 hex: 270F hex:	Leak (LEAK) Second leak (2nd-LEAK) Leak spreading (Ex-LEAK) Disconnection (BREAK CABLE) RTC ERROR (RTCERR) No event
	0505	Leak Position	0000 to 02BB hex: 270F hex:	0 to 699 m No
	0506	Leak Area	0001 to 0014 hex: 0000 hex: 270F hex:	1 to 20 (leak area) Not set No leak
Event Log 4	0600	Event	0000 hex: 0001 hex:	No Yes
	0601	Year	07D0 to 0833 hex: 270F hex:	2000 to 2099 No event
	0602	Month and Day	01 to 0C hex: 01 to 1F hex: 270F hex:	January to December 1 to 31 No event
	0603	Hours and Minutes	00 to 17 hex: 00 to 3B hex: 270F hex:	0 to 23 0 to 59 No event
	0604	Type of Event	0001 hex: 0002 hex: 0003 hex: 0004 hex: 0005 hex: 270F hex:	Leak (LEAK) Second leak (2nd-LEAK) Leak spreading (Ex-LEAK) Disconnection (BREAK CABLE) RTC ERROR (RTCERR) No event
	0605	Leak Position	0000 to 02BB hex: 270F hex:	0 to 699 m No
	0606	Leak Area	0001 to 0014 hex: 0000 hex: 270F hex:	1 to 20 (leak area) Not set No leak

Item	Address	Parameter name	Setting/monitor values	
Event Log 5	0700	Event	0000 hex: 0001 hex:	No Yes
	0701	Year	07D0 to 0833 hex: 270F hex:	2000 to 2099 No event
	0702	Month and Day	01 to 0C hex: 01 to 1F hex: 270F hex:	January to December 1 to 31 No event
	0703	Hours and Minutes	00 to 17 hex: 00 to 3B hex: 270F hex:	0 to 23 0 to 59 No event
	0704	Type of Event	0001 hex: 0002 hex: 0003 hex: 0004 hex: 0005 hex: 270F hex:	Leak (LEAK) Second leak (2nd-LEAK) Leak spreading (Ex-LEAK) Disconnection (BREAK CABLE) RTC ERROR (RTCERR) No event
	0705	Leak Position	0000 to 02BB hex: 270F hex:	0 to 699 m No
	0706	Leak Area	0001 to 0014 hex: 0000 hex: 270F hex:	1 to 20 (leak area) Not set No leak
Event Log 6	0800	Event	0000 hex: 0001 hex:	No Yes
	0801	Year	07D0 to 0833 hex: 270F hex:	2000 to 2099 No event
	0802	Month and Day	01 to 0C hex: 01 to 1F hex: 270F hex:	January to December 1 to 31 No event
	0803	Hours and Minutes	00 to 17 hex: 00 to 3B hex: 270F hex:	0 to 23 0 to 59 No event
	0804	Type of Event	0001 hex: 0002 hex: 0003 hex: 0004 hex: 0005 hex: 270F hex:	Leak (LEAK) Second leak (2nd-LEAK) Leak spreading (Ex-LEAK) Disconnection (BREAK CABLE) RTC ERROR (RTCERR) No event
	0805	Leak Position	0000 to 02BB hex: 270F hex:	0 to 699 m No
	0806	Leak Area	0001 to 0014 hex: 0000 hex: 270F hex:	1 to 20 (leak area) Not set No leak

Item	Address	Parameter name	Setting/monitor values	
Event Log 7	0900	Event	0000 hex: 0001 hex:	No Yes
	0901	Year	07D0 to 0833 hex: 270F hex:	2000 to 2099 No event
	0902	Month and Day	01 to 0C hex: 01 to 1F hex: 270F hex:	January to December 1 to 31 No event
	0903	Hours and Minutes	00 to 17 hex: 00 to 3B hex: 270F hex:	0 to 23 0 to 59 No event
	0904	Type of Event	0001 hex: 0002 hex: 0003 hex: 0004 hex: 0005 hex: 270F hex:	Leak (LEAK) Second leak (2nd-LEAK) Leak spreading (Ex-LEAK) Disconnection (BREAK CABLE) RTC ERROR (RTCERR) No event
	0905	Leak Position	0000 to 02BB hex: 270F hex:	0 to 699 m No
	0906	Leak Area	0001 to 0014 hex: 0000 hex: 270F hex:	1 to 20 (leak area) Not set No leak
Event Log 8	0A00	Event	0000 hex: 0001 hex:	No Yes
	0A01	Year	07D0 to 0833 hex: H270F hex:	2000 to 2099 No event
	0A02	Month and Day	01 to 0C hex: 01 to 1F hex: 270F hex:	January to December 1 to 31 No event
	0A03	Hours and Minutes	00 to 17 hex: 00 to 3B hex: 270F hex:	0 to 23 0 to 59 No event
	0A04	Type of Event	0001 hex: 0002 hex: 0003 hex: 0004 hex: 0005 hex: 270F hex:	Leak (LEAK) Second leak (2nd-LEAK) Leak spreading (Ex-LEAK) Disconnection (BREAK CABLE) RTC ERROR (RTCERR) No event
	0A05	Leak Position	0000 to 02BB hex: 270F hex:	0 to 699 m No
	0A06	Leak Area	0001 to 0014 hex: 0000 hex: 270F hex:	1 to 20 (leak area) Not set No leak

Item	Address	Parameter name	Setting/monitor values	
Event Log 9	0B00	Event	0000 hex: 0001 hex:	No Yes
	0B01	Year	07D0 to 0833 hex: 270F hex:	2000 to 2099 No event
	0B02	Month and Day	01 to 0C hex: 01 to 1F hex: 270F hex:	January to December 1 to 31 No event
	0B03	Hours and Minutes	00 to 17 hex: 00 to 3B hex: 270F hex:	0 to 23 0 to 59 No event
	0B04	Type of Event	0001 hex: 0002 hex: 0003 hex: 0004 hex: 0005 hex: 270F hex:	Leak (LEAK) Second leak (2nd-LEAK) Leak spreading (Ex-LEAK) Disconnection (BREAK CABLE) RTC ERROR (RTCERR) No event
	0B05	Leak Position	0000 to 02BB hex: 270F hex:	0 to 699 m No
	0B06	Leak Area	0001 to 0014 hex: 0000 hex: 270F hex:	1 to 20 (leak area) Not set No leak
Event Log 10	0C00	Event	0000 hex: 0001 hex:	No Yes
	0C01	Year	07D0 to 0833 hex: 270F hex:	2000 to 2099 No event
	0C02	Month and Day	01 to 0C hex: 01 to 1F hex: 270F hex:	January to December 1 to 31 No event
	0C03	Hours and Minutes	00 to 17 hex: 00 to 3B hex: 270F hex:	0 to 23 0 to 59 No event
	0C04	Type of Event	0001 hex: 0002 hex: 0003 hex: 0004 hex: 0005 hex: 270F hex:	Leak (LEAK) Second leak (2nd-LEAK) Leak spreading (Ex-LEAK) Disconnection (BREAK CABLE) RTC ERROR (RTCERR) No event
	0C05	Leak Position	0000 to 02BB hex: 270F hex:	0 to 699 m No
	0C06	Leak Area	0001 to 0014 hex: 0000 hex: 270F hex:	1 to 20 (leak area) Not set No leak

Item	Address	Parameter name	Setting/monitor values	
Event Log 11	0D00	Event	0000 hex: 0001 hex:	No Yes
	0D01	Year	07D0 to 0833 hex: 270F hex:	2000 to 2099 No event
	0D02	Month and Day	01 to 0C hex: 01 to 1F hex: 270F hex:	January to December 1 to 31 No event
	0D03	Hours and Minutes	00 to 17 hex: 00 to 3B hex: 270F hex:	0 to 23 0 to 59 No event
	0D04	Type of Event	0001 hex: 0002 hex: 0003 hex: 0004 hex: 0005 hex: 270F hex:	Leak (LEAK) Second leak (2nd-LEAK) Leak spreading (Ex-LEAK) Disconnection (BREAK CABLE) RTC ERROR (RTCERR) No event
	0D05	Leak Position	0000 to 02BB hex: 270F hex:	0 to 699 m No
	0D06	Leak Area	0001 to 0014 hex: 0000 hex: 270F hex:	1 to 20 (leak area) Not set No leak
Event Log 12	0E00	Event	0000 hex: 0001 hex:	No Yes
	0E01	Year	07D0 to 0833 hex: 270F hex:	2000 to 2099 No event
	0E02	Month and Day	01 to 0C hex: 01 to 1F hex: 270F hex:	January to December 1 to 31 No event
	0E03	Hours and Minutes	00 to 17 hex: 00 to 3B hex: 270F hex:	0 to 23 0 to 59 No event
	0E04	Type of Event	0001 hex: 0002 hex: 0003 hex: 0004 hex: 0005 hex: 270F hex:	Leak (LEAK) Second leak (2nd-LEAK) Leak spreading (Ex-LEAK) Disconnection (BREAK CABLE) RTC ERROR (RTCERR) No event
	0E05	Leak Position	0000 to 02BB hex: 270F hex:	0 to 699 m No
	0E06	Leak Area	0001 to 0014 hex: 0000 hex: 270F hex:	1 to 20 (leak area) Not set No leak

Item	Address	Parameter name	Setting/monitor values	
Event Log 13	0F00	Event	0000 hex: 0001 hex:	No Yes
	0F01	Year	07D0 to 0833 hex: 270F hex:	2000 to 2099 No event
	0F02	Month and Day	01 to 0C hex: 01 to 1F hex: 270F hex:	January to December 1 to 31 No event
	0F03	Hours and Minutes	00 to 17 hex: 00 to 3B hex: 270F hex:	0 to 23 0 to 59 No event
	0F04	Type of Event	0001 hex: 0002 hex: 0003 hex: 0004 hex: 0005 hex: 270F hex:	Leak (LEAK) Second leak (2nd-LEAK) Leak spreading (Ex-LEAK) Disconnection (BREAK CABLE) RTC ERROR (RTCERR) No event
	0F05	Leak Position	0000 to 02BB hex: 270F hex:	0 to 699 m No
	0F06	Leak Area	0001 to 0014 hex: 0000 hex: 270F hex:	1 to 20 (leak area) Not set No leak
Event Log 14	1000	Event	0000 hex: 0001 hex:	No Yes
	1001	Year	07D0 to 0833 hex: 270F hex:	2000 to 2099 No event
	1002	Month and Day	01 to 0C hex: 01 to 1F hex: 270F hex:	January to December 1 to 31 No event
	1003	Hours and Minutes	00 to 17 hex: 00 to 3B hex: 270F hex:	0 to 23 0 to 59 No event
	1004	Type of Event	0001 hex: 0002 hex: 0003 hex: 0004 hex: 0005 hex: 270F hex:	Leak (LEAK) Second leak (2nd-LEAK) Leak spreading (Ex-LEAK) Disconnection (BREAK CABLE) RTC ERROR (RTCERR) No event
	1005	Leak Position	0000 to 02BB hex: 270F hex:	0 to 699 m No
	1006	Leak Area	0001 to 0014 hex: 0000 hex: 270F hex:	1 to 20 (leak area) Not set No leak

Item	Address	Parameter name	Setting/monitor values	
Event Log 15	1100	Event	0000 hex: 0001 hex:	No Yes
	1101	Year	07D0 to 0833 hex: 270F hex:	2000 to 2099 No event
	1102	Month and Day	01 to 0C hex: 01 to 1F hex: 270F hex:	January to December 1 to 31 No event
	1103	Hours and Minutes	00 to 17 hex: 00 to 3B hex: 270F hex:	0 to 23 0 to 59 No event
	1104	Type of Event	0001 hex: 0002 hex: 0003 hex: 0004 hex: 0005 hex: 270F hex:	Leak (LEAK) Second leak (2nd-LEAK) Leak spreading (Ex-LEAK) Disconnection (BREAK CABLE) RTC ERROR (RTCERR) No event
	1105	Leak Position	0000 to 02BB hex: 270F hex:	0 to 699 m No
	1106	Leak Area	0001 to 0014 hex: 0000 hex: 270F hex:	1 to 20 (leak area) Not set No leak
Event Log 16	1200	Event	0000 hex: 0001 hex:	No Yes
	1201	Year	07D0 to 0833 hex: 270F hex:	2000 to 2099 No event
	1202	Month and Day	01 to 0C hex: 01 to 1F hex: 270F hex:	January to December 1 to 31 No event
	1203	Hours and Minutes	00 to 17 hex: 00 to 3B hex: 270F hex:	0 to 23 0 to 59 No event
	1204	Type of Event	0001 hex: 0002 hex: 0003 hex: 0004 hex: 0005 hex: 270F hex:	Leak (LEAK) Second leak (2nd-LEAK) Leak spreading (Ex-LEAK) Disconnection (BREAK CABLE) RTC ERROR (RTCERR) No event
	1205	Leak Position	0000 to 02BB hex: 270F hex:	0 to 699 m No
	1206	Leak Area	0001 to 0014 hex: 0000 hex: 270F hex:	1 to 20 (leak area) Not set No leak

Item	Address	Parameter name	Setting/monitor values	
Event Log 17	1300	Event	0000 hex: 0001 hex:	No Yes
	1301	Year	07D0 to 0833 hex: 270F hex:	2000 to 2099 No event
	1302	Month and Day	01 to 0C hex: 01 to 1F hex: 270F hex:	January to December 1 to 31 No event
	1303	Hours and Minutes	00 to 17 hex: 00 to 3B hex: 270F hex:	0 to 23 0 to 59 No event
	1304	Type of Event	0001 hex: 0002 hex: 0003 hex: 0004 hex: 0005 hex: 270F hex:	Leak (LEAK) Second leak (2nd-LEAK) Leak spreading (Ex-LEAK) Disconnection (BREAK CABLE) RTC ERROR (RTCERR) No event
	1305	Leak Position	0000 to 02BB hex: 270F hex:	0 to 699 m No
	1306	Leak Area	0001 to 0014 hex: 0000 hex: 270F hex:	1 to 20 (leak area) Not set No leak
Event Log 18	1400	Event	0000 hex: 0001 hex:	No Yes
	1401	Year	07D0 to 0833 hex: 270F hex:	2000 to 2099 No event
	1402	Month and Day	01 to 0C hex: 01 to 1F hex: 270F hex:	January to December 1 to 31 No event
	1403	Hours and Minutes	00 to 17 hex: 00 to 3B hex: 270F hex:	0 to 23 0 to 59 No event
	1404	Type of Event	0001 hex: 0002 hex: 0003 hex: 0004 hex: 0005 hex: 270F hex:	Leak (LEAK) Second leak (2nd-LEAK) Leak spreading (Ex-LEAK) Disconnection (BREAK CABLE) RTC ERROR (RTCERR) No event
	1405	Leak Position	0000 to 02BB hex: 270F hex:	0 to 699 m No
	1406	Leak Area	0001 to 0014 hex: 0000 hex: 270F hex:	1 to 20 (leak area) Not set No leak

Item	Address	Parameter name	Setting/monitor values	
Event Log 19	1500	Event	0000 hex: 0001 hex:	No Yes
	1501	Year	07D0 to 0833 hex: 270F hex:	2000 to 2099 No event
	1502	Month and Day	01 to 0C hex: 01 to 1F hex: 270F hex:	January to December 1 to 31 No event
	1503	Hours and Minutes	00 to 17 hex: 00 to 3B hex: 270F hex:	0 to 23 0 to 59 No event
	1504	Type of Event	0001 hex: 0002 hex: 0003 hex: 0004 hex: 0005 hex: 270F hex:	Leak (LEAK) Second leak (2nd-LEAK) Leak spreading (Ex-LEAK) Disconnection (BREAK CABLE) RTC ERROR (RTCERR) No event
	1505	Leak Position	0000 to 02BB hex: 270F hex:	0 to 699 m No
	1506	Leak Area	0001 to 0014 hex: 0000 hex: 270F hex:	1 to 20 (leak area) Not set No leak
Event Log 20	1600	Event	0000 hex: 0001 hex:	No Yes
	1601	Year	07D0 to 0833 hex: 270F hex:	2000 to 2099 No event
	1602	Month and Day	01 to 0C hex: 01 to 1F hex: 270F hex:	January to December 1 to 31 No event
	1603	Hours and Minutes	00 to 17 hex: 00 to 3B hex: 270F hex:	0 to 23 0 to 59 No event
	1604	Type of Event	0001 hex: 0002 hex: 0003 hex: 0004 hex: 0005 hex: 270F hex:	Leak (LEAK) Second leak (2nd-LEAK) Leak spreading (Ex-LEAK) Disconnection (BREAK CABLE) RTC ERROR (RTCERR) No event
	1605	Leak Position	0000 to 02BB hex: 270F hex:	0 to 699 m No
	1606	Leak Area	0001 to 0014 hex: 0000 hex: 270F hex:	1 to 20 (leak area) Not set No leak

Item	Address	Parameter name	Setting/monitor values	
Area 1	2100	Area 1 Name, 1	Characters 1 and 2:	Refer to character code table.
	2101	Area 1 Name, 2	Characters 3 and 4:	Refer to character code table.
	2102	Area 1 Name, 3	Characters 5 and 6:	Refer to character code table.
	2103	Area 1 Name, 4	Characters 7 and 8:	Refer to character code table.
	2104	Area 1 Start Distance	0000 hex:	0 m
	2105	Area 1 End Distance	0001 to 02BB hex:	1 m to 699 m
	2106	Short Position with Area	0000 to 02BB hex: 270F hex:	0 m to 699 m No short
Area 2	2200	Area 2 Name, 1	Characters 1 and 2:	Refer to character code table.
	2201	Area 2 Name, 2	Characters 3 and 4:	Refer to character code table.
	2202	Area 2 Name, 3	Characters 5 and 6:	Refer to character code table.
	2203	Area 2 Name, 4	Characters 7 and 8:	Refer to character code table.
	2204	Area 2 Start Distance	0002 to 02BA hex:	2 m to 698 m
	2205	Area 2 End Distance	0003 to 02BB hex:	3 m to 699 m
	2206	Short Position with Area	0000 to 02BB hex: 270F hex:	0 m to 699 m No short
Area 3	2300	Area 3 Name, 1	Characters 1 and 2:	Refer to character code table.
	2301	Area 3 Name, 2	Characters 3 and 4:	Refer to character code table.
	2302	Area 3 Name, 3	Characters 5 and 6:	Refer to character code table.
	2303	Area 3 Name, 4	Characters 7 and 8:	Refer to character code table.
	2304	Area 3 Start Distance	0003 to 02BA hex:	3 m to 698 m
	2305	Area 3 End Distance	0004 to 02BB hex:	4 m to 699 m
	2306	Short Position with Area	0000 to 02BB hex: 270F hex:	0 m to 699 m No short
Area 4	2400	Area 4 Name, 1	Characters 1 and 2:	Refer to character code table.
	2401	Area 4 Name, 2	Characters 3 and 4:	Refer to character code table.
	2402	Area 4 Name, 3	Characters 5 and 6:	Refer to character code table.
	2403	Area 4 Name, 4	Characters 7 and 8:	Refer to character code table.
	2404	Area 4 Start Distance	0004 to 02BA hex:	4 m to 698 m
	2405	Area 4 End Distance	0005 to 02BB hex:	5 m to 699 m
	2406	Short Position with Area	0000 to 02BB hex: 270F hex:	0 m to 699 m No short
Area 5	2500	Area 5 Name, 1	Characters 1 and 2:	Refer to character code table.
	2501	Area 5 Name, 2	Characters 3 and 4:	Refer to character code table.
	2502	Area 5 Name, 3	Characters 5 and 6:	Refer to character code table.
	2503	Area 5 Name, 4	Characters 7 and 8:	Refer to character code table.
	2504	Area 5 Start Distance	0005 to 02BA hex:	5 m to 698 m
	2505	Area 5 End Distance	0006 to 02BB hex:	6 m to 699 m
	2506	Short Position with Area	0000 to 02BB hex: 270F hex:	0 m to 699 m No short
Area 6	2600	Area 6 Name, 1	Characters 1 and 2:	Refer to character code table.
	2601	Area 6 Name, 2	Characters 3 and 4:	Refer to character code table.
	2602	Area 6 Name, 3	Characters 5 and 6:	Refer to character code table.
	2603	Area 6 Name, 4	Characters 7 and 8:	Refer to character code table.
	2604	Area 6 Start Distance	0006 to 02BA hex:	6 m to 698 m
	2605	Area 6 End Distance	0007 to 02BB hex:	7 m to 699 m
	2606	Short Position with Area	0000 to 02BB hex: 270F hex:	0 m to 699 m No short

Item	Address	Parameter name	Setting/monitor values	
Area 7	2700	Area 7 Name, 1	Characters 1 and 2:	Refer to character code table.
	2701	Area 7 Name, 2	Characters 3 and 4:	Refer to character code table.
	2702	Area 7 Name, 3	Characters 5 and 6:	Refer to character code table.
	2703	Area 7 Name, 4	Characters 7 and 8:	Refer to character code table.
	2704	Area 7 Start Distance	0007 to 02BA hex:	7 m to 698 m
	2705	Area 7 End Distance	0008 to 02BB hex:	8 m to 699 m
	2706	Short Position with Area	0000 to 02BB hex: 270F hex:	0 m to 699 m No short
Area 8	2800	Area 8 Name, 1	Characters 1 and 2:	Refer to character code table.
	2801	Area 8 Name, 2	Characters 3 and 4:	Refer to character code table.
	2802	Area 8 Name, 3	Characters 5 and 6:	Refer to character code table.
	2803	Area 8 Name, 4	Characters 7 and 8:	Refer to character code table.
	2804	Area 8 Start Distance	0008 to 02BA hex:	8 m to 698 m
	2805	Area 8 End Distance	0009 to 02BB hex:	9 m to 699 m
	2806	Short Position with Area	0000 to 02BB hex: 270F hex:	0 m to 699 m No short
Area 9	2900	Area 9 Name, 1	Characters 1 and 2:	Refer to character code table.
	2901	Area 9 Name, 2	Characters 3 and 4:	Refer to character code table.
	2902	Area 9 Name, 3	Characters 5 and 6:	Refer to character code table.
	2903	Area 9 Name, 4	Characters 7 and 8:	Refer to character code table.
	2904	Area 9 Start Distance	0009 to 02BA hex:	9 m to 698 m
	2905	Area 9 End Distance	000A to 02BB hex:	10 m to 699 m
	2906	Short Position with Area	0000 to 02BB hex: 270F hex:	0 m to 699 m No short
Area 10	2A00	Area 10 Name, 1	Characters 1 and 2:	Refer to character code table.
	2A01	Area 10 Name, 2	Characters 3 and 4:	Refer to character code table.
	2A02	Area 10 Name, 3	Characters 5 and 6:	Refer to character code table.
	2A03	Area 10 Name, 4	Characters 7 and 8:	Refer to character code table.
	2A04	Area 10 Start Distance	000A to 02BA hex:	10 m to 698 m
	2A05	Area 10 End Distance	000B to 02BB hex:	11 m to 699 m
	2A06	Short Position with Area	0000 to 02BB hex: 270F hex:	0 m to 699 m No short
Area 11	2B00	Area 11 Name, 1	Characters 1 and 2:	Refer to character code table.
	2B01	Area 11 Name, 2	Characters 3 and 4:	Refer to character code table.
	2B02	Area 11 Name, 3	Characters 5 and 6:	Refer to character code table.
	2B03	Area 11 Name, 4	Characters 7 and 8:	Refer to character code table.
	2B04	Area 11 Start Distance	000B to 02BA hex:	11 m to 698 m
	2B05	Area 11 End Distance	000C to 02BB hex:	12 m to 699 m
	2B06	Short Position with Area	0000 to 02BB hex: 270F hex:	0 m to 699 m No short
Area 12	2C00	Area 12 Name, 1	Characters 1 and 2:	Refer to character code table.
	2C01	Area 12 Name, 2	Characters 3 and 4:	Refer to character code table.
	2C02	Area 12 Name, 3	Characters 5 and 6:	Refer to character code table.
	2C03	Area 12 Name, 4	Characters 7 and 8:	Refer to character code table.
	2C04	Area 12 Start Distance	000C to 02BA hex:	12 m to 698 m
	2C05	Area 12 End Distance	000D to 02BB hex:	13 m to 699 m
	2C06	Short Position with Area	0000 to 02BB hex: 270F hex:	0 m to 699 m No short

Item	Address	Parameter name	Setting/monitor values	
Area 13	2D00	Area 13 Name, 1	Characters 1 and 2:	Refer to character code table.
	2D01	Area 13 Name, 2	Characters 3 and 4:	Refer to character code table.
	2D02	Area 13 Name, 3	Characters 5 and 6:	Refer to character code table.
	2D03	Area 13 Name, 4	Characters 7 and 8:	Refer to character code table.
	2D04	Area 13 Start Distance	000D to 02BA hex:	13 m to 698 m
	2D05	Area 13 End Distance	000E to 02BB hex:	14 m to 699 m
	2D06	Short Position with Area	0000 to 02BB hex: 270F hex:	0 m to 699 m No short
Area 14	2E00	Area 14 Name, 1	Characters 1 and 2:	Refer to character code table.
	2E01	Area 14 Name, 2	Characters 3 and 4:	Refer to character code table.
	2E02	Area 14 Name, 3	Characters 5 and 6:	Refer to character code table.
	2E03	Area 14 Name, 4	Characters 7 and 8:	Refer to character code table.
	2E04	Area 14 Start Distance	000E to 02BA hex:	14 m to 698 m
	2E05	Area 14 End Distance	000F to 02BB hex:	15 m to 699 m
	2E06	Short Position with Area	0000 to 02BB hex: 270F hex:	0 m to 699 m No short
Area 15	2F00	Area 15 Name, 1	Characters 1 and 2:	Refer to character code table.
	2F01	Area 15 Name, 2	Characters 3 and 4:	Refer to character code table.
	2F02	Area 15 Name, 3	Characters 5 and 6:	Refer to character code table.
	2F03	Area 15 Name, 4	Characters 7 and 8:	Refer to character code table.
	2F04	Area 15 Start Distance	000F to 02BA hex:	15 m to 698 m
	2F05	Area 15 End Distance	0010 to 02BB hex:	16 m to 699 m
	2F06	Short Position with Area	0000 to 02BB hex: 270F hex:	0 m to 699 m No short
Area 16	3000	Area 16 Name, 1	Characters 1 and 2:	Refer to character code table.
	3001	Area 16 Name, 2	Characters 3 and 4:	Refer to character code table.
	3002	Area 16 Name, 3	Characters 5 and 6:	Refer to character code table.
	3003	Area 16 Name, 4	Characters 7 and 8:	Refer to character code table.
	3004	Area 16 Start Distance	0010 to 02BA hex:	16 m to 698 m
	3005	Area 16 End Distance	0011 to 02BB hex:	17 m to 699 m
	3006	Short Position with Area	0000 to 02BB hex: 270F hex:	0 m to 699 m No short
Area 17	3100	Area 17 Name, 1	Characters 1 and 2:	Refer to character code table.
	3101	Area 17 Name, 2	Characters 3 and 4:	Refer to character code table.
	3102	Area 17 Name, 3	Characters 5 and 6:	Refer to character code table.
	3103	Area 17 Name, 4	Characters 7 and 8:	Refer to character code table.
	3104	Area 17 Start Distance	0011 to 02BA hex:	17 m to 698 m
	3105	Area 17 End Distance	0012 to 02BB hex:	18 m to 699 m
	3106	Short Position with Area	0000 to 02BB hex: 270F hex:	0 m to 699 m No short
Area 18	3200	Area 18 Name, 1	Characters 1 and 2:	Refer to character code table.
	3201	Area 18 Name, 2	Characters 3 and 4:	Refer to character code table.
	3202	Area 18 Name, 3	Characters 5 and 6:	Refer to character code table.
	3203	Area 18 Name, 4	Characters 7 and 8:	Refer to character code table.
	3204	Area 18 Start Distance	0012 to 02BA hex:	18 m to 698 m
	3205	Area 18 End Distance	0013 to 02BB hex:	19 m to 699 m
	3206	Short Position with Area	0000 to 02BB hex: 270F hex:	0 m to 699 m No short

Item	Address	Parameter name	Setting/monitor values
Area 19	3300	Area 19 Name, 1	Characters 1 and 2: Refer to character code table.
	3301	Area 19 Name, 2	Characters 3 and 4: Refer to character code table.
	3302	Area 19 Name, 3	Characters 5 and 6: Refer to character code table.
	3303	Area 19 Name, 4	Characters 7 and 8: Refer to character code table.
	3304	Area 19 Start Distance	0013 to 02BA hex: 19 m to 698 m
	3305	Area 19 End Distance	0014 to 02BB hex: 20 m to 699 m
	3306	Short Position with Area	0000 to 02BB hex: 0 m to 699 m 270F hex: No short
Area 20	3400	Area 20 Name, 1	Characters 1 and 2: Refer to character code table.
	3401	Area 20 Name, 2	Characters 3 and 4: Refer to character code table.
	3402	Area 20 Name, 3	Characters 5 and 6: Refer to character code table.
	3403	Area 20 Name, 4	Characters 7 and 8: Refer to character code table.
	3404	Area 20 Start Distance	0014 to 02BA hex: 20 m to 698 m
	3405	Area 20 End Distance	02BB hex: 699 m
	3406	Short Position with Area	0000 to 02BB hex: 0 m to 699 m 270F hex: No short
Controller Attributes	3D00	K7	4B37 hex: Refer to character code table.
	3D01	L-	4C2D hex: Refer to character code table.
	3D02	UP	5550 hex: Refer to character code table.
	3D03	-F	2D46 hex: Refer to character code table.
	3D04	LK	4C4B hex: Refer to character code table.
Controller Status	3E00	Status	Operating status: 00 to 02 hex Event/error status: 00 to 3F hex
Time Information	3F00	Year	07D0 to 0833 hex: 2000 to 2099
	3F01	Month and Day	01 to 0C, 01 to 1F hex: January to December, 1 to 31
	3F02	Hour and Minutes	00 to 17, 00 to 3B hex: 0 to 23, 0 to 59
	3F03	Seconds	0000 to 003B hex: 0 to 59

Note: 1. The shaded areas are read-only parameters.

2. A parameter error will occur if 20 areas are set and a distance is set that is shorter than the present end distance.
3. A distance cannot be set for area 20.
4. The Short Position with Area can be checked only if areas have been created.
5. Refer to the appendix for a table of character codes that can be used.
6. An operation error will occur if an attempt is made to write or read data when the area settings are disabled. If the area settings are enabled and not set, an error will occur if an attempt is made to write to or read from an address.
7. Refer to 9.2 Status for information on Controller statuses.

9.2 Status

This section describes status data.

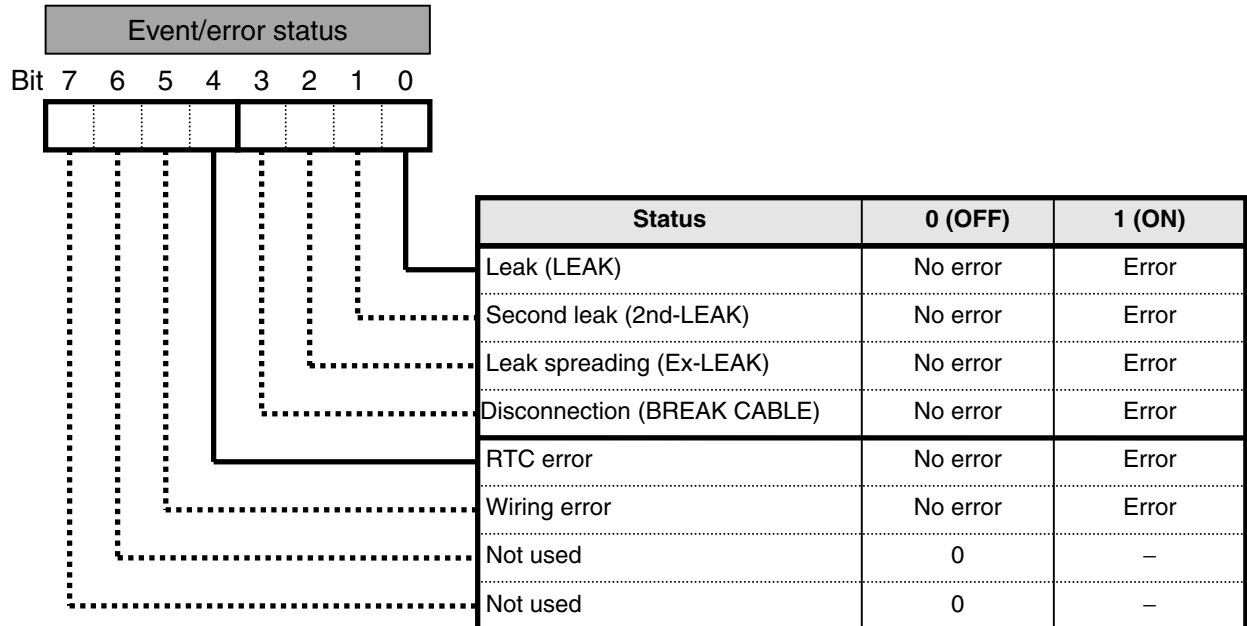

Note: 1. ON (1) will be set when the relevant event occurs.

2. Unused bits are always OFF (0).

The following describes Controller status.

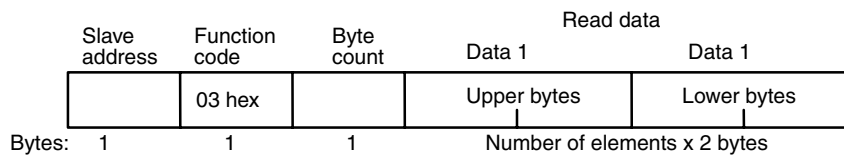

The following table gives the status of the upper bytes of data 1.

Operating status	Description
00	Monitoring (No event or error occurred.)
01	Monitoring (Event or error occurred.)
02	Other than the above

The following table gives the status of the lower bytes of data 1.

Example:

Event/error status	Bit status	Lower bytes of data 1
Leak (LEAK)	00000001	01
Disconnection (BREAK CABLE)	00001000	08
Cable error (CABLE ERR)	00100000	20

9.3 Possible Communications Range

The following table shows the possible communications ranges.

Status	Variable Area		Controller Attribute Read	Controller Status Read	Time Data Read	Time Data Write	Echoback Test	Operation Commands				
	Read	Write						Operation Level Setting	Parameter Initialization	Reset	Change Protection Level	Clear Area
Monitoring		x				x			x		x	x
Setting									x	x		
Leak		x				x		x	x		x	x
Disconnection		x				x			x		x	x
Protection Mode (See note.)		x				x			x	x		x
Unit error Turning ON power supply	Communications are not possible in some status.											

x: An error response (operation error) is returned. An operation error will occur if an attempt is made to read or write communications in other status for which communications are prohibited (e.g., performing communications during testing).

Blank: A normal response is returned if a normal command is executed.

Note: Enter Protection Mode by pressing the **ALT + DEL** Keys for 3 s.



Section 10 Troubleshooting

| 10.1 Troubleshooting10-2

10.1 Troubleshooting

If the K7L-UP-FLK or communications are not operating correctly, check the following items before concluding that there is a fault or that repair is required. If communications continue to operate incorrectly after the following items have been checked and the corrective actions have been taken, consult your OMRON sales representative.

■ Troubleshooting Problems with the K7L-UP-FLK

Symptom	Item to check	Countermeasure	Reference
Monitor Mode is not entered when the OK Button is pressed.	Is protection set?	Go into Protection Mode and change the protection level.	4.25 Setting Protection
Settings cannot be changed.	Is the mode still Monitor Mode?	Select SETTING to go into Setting Mode.	Entering the Setting Mode (page 4.2)
Outputs cannot be reset even after an event has been cleared.	Is the manual 2 reset method set?	Press the ESC and ALT Buttons to reset the outputs.	4.13 Setting the Output Reset Method
When a leak test was performed, the area that was displayed was not the one that was set.	Was the zero shift or correction value set after the areas were set?	The zero shift and correction value must be set before the areas are set. Set the area again.	4.9 Setting Detection Areas
A different area was displayed from the one in which a leak occurred.	Was the leak at the boundary between areas?	Use an Area Separator. If an Area Separator is not used, try setting the area where leaks are not detected at the boundary to 1% or more of the total cable length to allow leeway in the Sensing Cables.	4.11 Editing Detection Areas
When a leak test was performed, the value that was output was not the linear output (4 to 20 mA) that was set.	Was the zero shift or correction value set after the linear output (4 to 20 mA) was set?	The zero shift and correction value must be set before the linear output (4 to 20 mA) is set. Set the linear output (4 to 20 mA) again.	4.15 Setting the Linear Output (4 to 20 mA)
A second leak occurred and the initial leak was cleaned up and dried, but the distance displayed for the second leak showed a position different from the actual location.	Was the Sensing Cable cleaned and dried sufficiently at the position of the initial leak?	Dry the Sensing Cable completely.	–
The Sensing Cable was short-circuited, but the displayed distance showed a position different from the actual location.	Was the Sensing Cable sufficiently short-circuited?	Use a commercially available metal brush to short-circuit the Sensing Cable, and press down for at least 45 s.	4.23 Short-circuiting a Sensing Cable
The total cable length changed when the Sensing Cable was replaced.	There is a Sensing Cable error.	Correct the correction value, area, and 4 to 20 mA settings.	–
An EEPROM error is indicated on the display on the Sensor.	An error has occurred in the EEPROM.	Turn ON the power again. If the error occurs again, the Sensor must be repaired.	3.3 Procedures When Problems Are Detected
An RTC error is indicated on the display on the Sensor.	An error has occurred in the clock IC.	Turn ON the power again. If the error occurs again, the Sensor must be repaired.	3.3 Procedures When Problems Are Detected
A wiring error is indicated on the display on the Sensor.	Is the Sensing Cable 699 m or longer?	Correct the wiring.	3.3 Procedures When Problems Are Detected

■ Problem: Communications is not possible or a communications error occurs.

Description	Corrective action	Page
The communications connections are incorrect.	Correct the connections.	–
Communications is disconnected.	Connect the connections firmly and secure them with screws.	–
The communications cables are disconnected.	Replace the cables.	–
The communications cables are too long.	The maximum total length is 500 m.	5-4
Inappropriate communications cables are being used.	Use shielded twist-pair cable (AWG28 to AWG16) for the communications cable.	5-4
The number of communications devices on the same transmission line exceeds the specification (RS-485 only).	A maximum of 32 nodes including the host device can be connected if 1:N connections are used with RS-485.	5-4
Both ends of the transmission line are not specified as end nodes (RS-485 only).	Set and install terminating resistors. When doing so, use a 120-Ω (1/2-W) terminating resistor at the end node on the K7L-UP-FLK and use a combined resistance with the terminating resistor at the host device of 54 Ω min.	5-4
Power is not being supplied to the Unit.	Apply the specified power supply voltage.	–
Power is not being supplied to the RS-232C/RS-485 Interface Converter (e.g., K3SC).	Apply the specified power supply voltage.	–
The baud rate or communications method of the Unit, host device, and other devices on the same transmission path are not the same.	Set the protocol, baud rate, data bit length, stop bit length, and parity bit so that they are the same for all nodes.	5-4
The unit number of the Unit is different from the unit number specified in the command frame.	Set the unit numbers so that they match.	6-2 8-2
The Unit has the same unit number as another device on the same transmission path (RS-485 only).	Do not use the same unit number more than once.	5-4
There is an error in the host device programming.	Use a line monitor to check the command. Check operation by using a sample program.	–
The host device detects a no-response error before the response from the Unit is received.	Decrease the response waiting time of the Unit. Increase the response waiting time of the host device.	5-4
The host device detects an error when no response is returned after a broadcast transmission or parameter initialization command is sent.	Responses are not returned from the Unit for broadcast transmissions or parameter initialization.	6-2 8-2 8-5
The host device sends the next command before the response from the Unit is received	Always read the response after sending a command (except for broadcast transmissions and parameter initialization).	–
The time period from when the response is received from the Unit until the command is sent from the host device is too short.	Allow a period of 2 ms min between receiving a response and sending a command.	5-3
The transmission line becomes unstable when the Unit power supply is turned ON or OFF, and the host device reads this as data.	Initialize the receive buffer of the host device before sending the first command and after the Unit power supply is turned ON.	–
The communications data is incorrect due to noise in the surroundings.	Decrease the baud rate and try again. Separate the communications cables from the source of the noise. Replace the communications cables with shielded twist-pair cables. Keep the communications cables as short as possible and do not wind up or loop any extra cable. Do not install communications cables and power cables in parallel. Doing so may result in inductive noise. If providing measures against noise is a problem, consider using an optical interface.	–



Appendices

A.1	Product Specifications.....	A-2
A.2	Table of Parameters.....	A-7
A.3	Table of Characters	A-8

A.1 Product Specifications

■ K7L-UP-FLK

● Ratings and Performance

Power supply voltage		100 to 240 VAC at 50/60 Hz
Allowable voltage fluctuation range		85 to 264 VAC
Power consumption		10 VA max.
Operate resistance (See note 1.)		50 or 100 kΩ (Can be changed by using the sensitivity setting.) Operates at the sensitivity set value or below.
Release resistance		350 kΩ min.
Current when electrodes are shorted		2 mA AC max.
Leakage position detection accuracy (See notes 1 and 2)		±1 m max. (Total cable length: 100 m max.)
		±1% max. (Total cable length: 101 to 600 m)
Disconnection detection	Detection signal	10 VDC
	Detection time	45 s max.
	Detection reset	After correct wiring is restored
Response time		45 s max.
Startup time after power is turned ON		30 s max.
Display	LCD display	12 characters by 4 rows
	Backlight	Normal: Lit green
		Error: Flashing green
		Leakage detected: Lit red
		Disconnection detected: Flashing red
Insulation resistance	Between (1) and (3): 20 MΩ min. at 500 VDC	(1) Power supply terminals
		(2) Relay output terminals
		(3) All terminals together excluding (1) and (2)
Dielectric strength	2,000 VAC at 50/60 Hz for 1 min	Same as for insulation resistance.
Vibration resistance		Frequency: 10 to 55 Hz, Acceleration: 50 m/s ² , Single amplitude: 0.35 mm, 10 sweeps of 5 min each in X, Y, and Z directions
Shock resistance		130 m/s ² , 3 times each in six directions (up, down, left, right, front, back)
Relay output		NO contacts x 2 outputs
	Rated load	3 A, 250 VAC/30 VDC
	Resistive load	3 A, 250 VAC/30 VDC
	Inductive load	1 A, 250 VAC/30 VDC
	Service life	Mechanical: 20 million outputs
		Electrical: 80,000 outputs
	Failure rate P value	24 VDC at 5 mA (reference value)
Contact resistance	100 mΩ max. (default)	

Note: 1. This product detects changes in the electrical resistance of liquids. The performance of the product specified in this document may not be obtained for some types of liquids. Always perform tests in advance before purchasing the product to confirm applicability.

2. The liquid position detection accuracy is the accuracy of the Sensor itself. Error will also occur in the Sensing Cable. Adjust the accuracy of the Sensing Cable by setting the zero shift and correction functions.

Linear output	4 to 20 mA ($\pm 1\%$ FS) (Load resistance: 500 Ω max.)	
	Steady state	4 mA
	At error detection	5 mA
	At disconnection detection	20 mA
	At leakage detection	6 + 12 x leak position (m)/L (m) mA L: Set distance (default: 600 m)
Clock accuracy	Maximum error: 1.5 min/month (at an ambient temperature of 25°C)	
Protection for power interruptions	Calendar/clock (month, date, day, hour) Time held: 7 days min. (at an ambient temperature of 25°C)	
Ambient operating temperature	-10 to 55°C (No icing)	
Ambient operating humidity	25% to 85% (No condensation)	
Wiring distance	600 m max. (Total of Sensing Cables, Connecting Cables, Junction Cables, Area Separators and general-purpose cables) 600 V, 0.75 mm ² , when 3-core vinyl cabtyre cable Junction Cable: 10 max. (20 m max.) Area Separators are calculated as 10 m each.	
Terminal block tightening torque	0.5 to 0.6 N·m	

● **Communications**

	CompoWay/F	Modbus (RTU Mode)
Transmission line connection	Multidrop (32 nodes max. including Master)	
Communications method	RS-485 (two-wire method, half-duplex)	
Synchronization method	Start-stop synchronization	
Baud rate	4.8, 9.6, 19.2, 38.4 kbps	
Communications code	ASCII	Binary
Data bit length	7 or 8 bits	8 bits (not set)
Stop bit length	1 or 2 bits	Set automatically (no setting) depending on the parity bit setting. No parity bit: 2 bits With parity bit: 1 bit
Error detection	Parity bit (none, even, odd) BCC (Block Check Character)	Parity bit (none, even, odd) CRC-16 (Cyclical Redundancy Check)
Communications response send delay	00 to 99 ms (default: 20 ms)	
Flow control	None	
Retry function	None	
Data interval	Not specified.	Less than 3.5 characters

■ **Sensing Cable: F03-16UP-C-□M**

(□ = Number of meters: 2: 2 m, 5: 5 m, 10: 10 m, 30: 30 m)

Number of electrodes		3
Conducting materials	Signal wire	Tin-plated annealed copper
	Resistance wire	Kermalloy
	Detection wire	Nickel
Insulation material		Fluororesin
Allowable pull force		125 N (reference value)
Allowable bending radius		50 mm
Insulation resistance		10 MΩ min.
Operating temperature range		-10 to 55°C
Operating humidity range		25% to 85%

■ **Connecting Cable: F03-21UP-CC**

Number of electrodes		3
Conducting materials	Signal wire	Tin-plated annealed copper
	Resistance wire	Tin-plated annealed copper
	Detection wire	Tin-plated annealed copper
Insulation material		PVC
Insulation resistance		10 MΩ min.
Operating temperature range		-10 to 55°C
Operating humidity range		25% to 85%

■ **Junction Cable: F03-21UP-JC**

Number of electrodes		3
Conducting materials	Signal wire	Tin-plated annealed copper
	Resistance wire	Tin-plated annealed copper
	Detection wire	Tin-plated annealed copper
	Insulation coating	PVC
Insulation resistance		10 MΩ min.
Operating temperature range		-10 to 55°C
Operating humidity range		25% to 85%

■ **Area Separator: F03-20UP-AS**

Number of electrodes		3
Insulation material		Polyolefin resin
Insulation resistance		10 MΩ min.
Operating temperature range		-10 to 55°C
Operating humidity range		25% to 85%

Note: The distance displayed for each Area Separator is equivalent to 10 m of Sensing Cable.

■ Terminator: F03-20UP-TC

Number of electrodes	3
Operating temperature range	-10 to 55°C
Operating humidity range	25% to 85%

The following materials are used for the connectors for the above Cables, Area Separator, and Terminator.

Metal section: Brass with nickel plating

Plastic section: polyolefin resin

Note: 1. Use F03-25 Sensing Band Stickers to secure cables.

2. When laying cables on the floor, use protective casing to prevent the cables from being damaged by being stepped on.

■ Cable Dimensions (Unit: mm)

- Sensing Cable: F03-16UP-C-□M

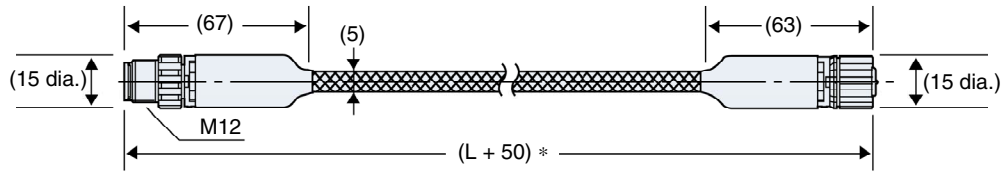

* L: 2m, 5m, 10m, 30m

- Connecting Cable: F03-21UP-CC

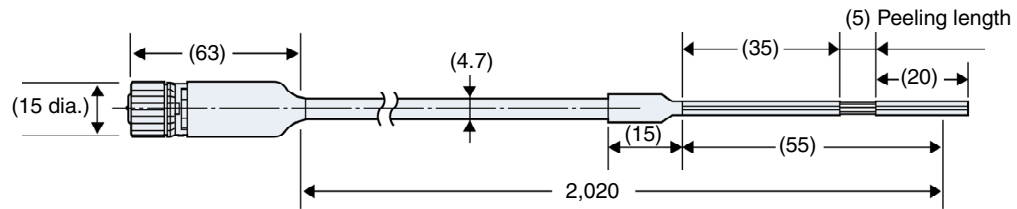

- Junction Cable: F03-21UP-JC

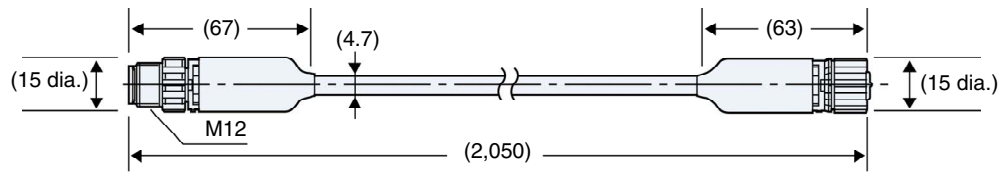

- Area Separator: F03-20UP-AS

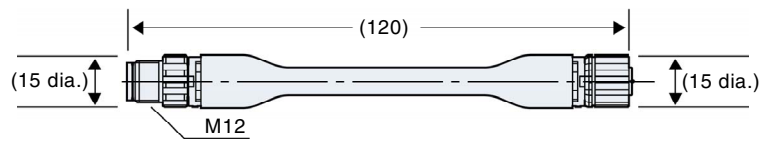

- Terminator: F03-20UP-TC

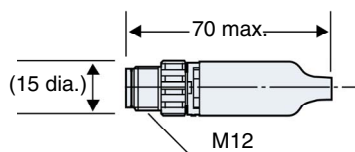

A.2 Table of Parameters

Level 1	Level 2	Level 3	Default	Parameter setting
PARAMETER	CABLE		–	0 to 699 m
	SENS		100 k Ω	50 or 100 k Ω
	AREA		INVALID	INVALID or 1 to 20
	ZERO		INVALID	INVALID or –100 to 0 m
	CORR		INVALID	INVALID or –100 to 100 m
	OUTPUT		NO	NO or NC
	RESET		MANU2	AUTO, MANU1, or MANU2
	NODE NO.		01	00 to 99 (Modbus: 01 to 99)
TIME			2000/01/01	Year: 00 to 99, Month: 01 to 12, Day: 01 to 31
			00:00	Hour: 00 to 23, Minutes: 00 to 59
LANGUAGE			ENGLISH	JAPANESE or ENGLISH
INPUT	SENS		100 k Ω	50 or 100 k Ω
	AREA	AREA SETTING	INVALID	VALID or INVALID
		AREA EDIT	0-699m	0 to 699 m
	ZERO	ZERO SET	INVALID	VALID or INVALID
		ZERO EDIT	0m	–100 to 0 m
	CORR	CORR SET	INVALID	VALID or INVALID
		CORR EDIT	0m	–100 to 100 m
OUTPUT	OUTPUT		NO	NO or NC
	RESET		MANU2	AUTO, MANU1, or MANU2
RS485	PROTOCOL		CompoWay/F	CompoWay/F or Modbus
	(CompoWay/F)	NODE NO.	1	00 to 99
		BAUD RATE	9600	4,800, 9,600, 19,200, or 38,400 bps
		DATA LENGTH	7	7 or 8 bits
		STOP BITS	2	1 or 2 bits
		PARITY	EVEN	NONE, EVEN, or ODD
		WAITING TIME	20	0 to 99 ms
	(Modbus)	NODE NO.	1	01 to 99
		BAUD RATE	9600	4,800, 9,600, 19,200, or 38,400 bps
		DATA LENGTH	8	8 bits
		STOP BITS	1	Parity even/odd: 1 bit No parity: 2 bits
		PARITY	EVEN	NONE, EVEN, or ODD
		WAITING TIME	20	0 to 99 ms
	4-20mA			600 m
OUTPUT TEST	LEAK TEST		0 m	0 to 699 m
	BREAK TEST		Not set	
	ERR TEST		Not set	
OTHERS	BACKLIGHT		2 min	2 min, 10 min, 30 min, or ON
	EVENT LOG		NONE	20 max.
	SYSTEM INF		Lot:*****	00000 to 99999, A to Z, a to z, none
PROTECT SET			LEVEL 0	LEVEL 0, LEVEL 1, or LEVEL 2

A.3 Table of Characters

	0	1	2	3	4	5	6	7	8	9	A	B	C	D	E	F
0			SP	0	@	P		p				ー	タ	ミ		
1			!	1	A	Q	a	q			。	ア	チ	ム		
2			"	2	B	R	b	r			「	イ	ツ	メ		
3			#	3	C	S	c	s			」	ウ	テ	モ		
4			\$	4	D	T	d	t			、	エ	ト	ヤ		
5			%	5	E	U	e	u			・	オ	ナ	ユ		
6			&	6	F	V	f	v			ヲ	カ	ニ	ヨ		
7			'	7	G	W	g	w			ア	キ	ヌ	ラ		
8			(8	H	X	h	x			イ	ク	ネ	リ		
9)	9	I	Y	i	y			ウ	ケ	ノ	ル		
A			*	:	J	Z	j	z			エ	コ	ハ	レ		
B			+	;	K	[k				オ	サ	ヒ	ロ		
C			,	<	L		l				ヤ	シ	フ	ワ		
D			-	=	M]	m				ユ	ス	ヘ	ン		
E			.	>	N	^	n				ヨ	セ	ホ	ゝ		
F			/	?	O	_	o				ツ	ソ	マ	。		

Note: A0 to DF are not used when English is set as the language.

Index

- A**
- addresses, CompoWay/F 6-8
 - addresses, Modbus 8-7
 - area definitions 6-6
 - Area Separator 1-2, 2-13, 4-26, A-4, A-6
 - area settings 1-2, 4-21
- B**
- backlight 1-3, 4-45
 - baud rate 5-5
 - BCC 6-2
 - button functions 4-4
- C**
- CABLE ERR 3-12
 - command frames, CompoWay/F 6-2
 - command frames, Modbus 8-2
 - command text 6-6
 - communications connections 5-4
 - communications data, CompoWay/F 7-1
 - communications data, Modbus 9-1
 - communications parameters 5-4
 - communications protocol 5-5
 - communications response send delay ... 5-5
 - communications specifications 5-3, A-3
 - CompoWay/F 5-2, 6-1, 7-1
 - Connecting Cable A-4, A-6
 - connecting cable connectors 2-8
 - connecting the Terminator 2-9
 - connection examples 2-12
 - connections, RS-485 5-4
 - contrast adjustment 3-2
 - Controller Attribute Read,
CompoWay/F 6-12
 - Controller Status Read 6-13
 - copy function 4-53
 - correction 1-2, 4-17
 - CRC-16 8-2, 8-3
- D**
- data bit length 5-5
 - data format, CompoWay/F 6-2
 - data format, Modbus 8-2
 - date and time setting 1-3, 4-7
 - detailed descriptions of services,
CompoWay/F 6-9
 - detailed descriptions of services,
Modbus 8-8
 - detection area 4-21
 - detection sensitivity 1-2, 3-5, 4-11
 - disconnection detection 1-2, 3-12
- E**
- echoback test, CompoWay/F 6-16
 - echoback test, Modbus 8-14
 - EEPROM ERR 3-12
 - end codes, CompoWay/F 6-4
 - error codes, Modbus 8-5
 - ETX 6-2
 - event log 1-3, 4-47
 - extending with Connecting and Junction
cables 2-10
 - external reset 2-6
- F**
- F03-25 2-11
 - FINS 5-2
 - function code 8-2, 8-4
 - function codes
communications, Modbus 8-6

I	
initialization	1-3, 4-50
interface	5-4

J	
Junction Cable	A-4, A-6

K	
key protection	1-3, 4-55

L	
language setting	3-3, 4-9
leak spreading	1-2, 3-10
linear output.....	1-3, 2-7, 4-38
list of functions.....	8-6
list of services.....	6-8

M	
Modbus	5-2, 8-1, 9-1
Monitor Mode.....	3-8, 4-3
mounting.....	2-2

N	
no response, Modbus	8-5
node number	6-2
number of elements, CompoWay/F	6-8
number of elements, Modbus	8-7

O	
operation commands, CompoWay/F	6-17
operation commands, Modbus	8-12
output reset.....	4-34
output test.....	1-3, 4-40

P	
parameters	4-6, A-7
parity bit	5-5
PDU structure	6-6
possible communications range, CompoWay/F.....	7-9
possible communications range, Modbus	9-18
product specifications.....	A-2

protection setting.....	4-55
protocol selection	5-5

R	
ratings and performance	A-2
Read from Variable Area, CompoWay/F .	6-9
Read from Variable Area, Modbus	8-8
recommended crimp terminals	2-5
recommended tools	2-5
relay output	1-3, 2-7, 4-32
removing	2-3
reset	1-3, 2-6, 4-34
response codes.....	6-20
response frames, CompoWay/F	6-3
response frames, Modbus	8-4
RS-485	2-7, 5-4
RTC ERR	3-12

S	
second leak.....	1-2, 3-11
Sensing Cable.....	A-4, A-6
Setting Communications	4-36
Setting Mode.....	3-9, 4-2
short-circuiting a Sensing Cable	4-52
SID	6-2
slave address	8-2, 8-4
status, CompoWay/F.....	7-8
status, Modbus.....	9-17
stop bit length.....	5-5
STX	6-2
sub-address	6-2
system information.....	4-49

T	
table of characters	A-8
Terminator	A-5, A-6
Time Data Read.....	6-14
Time Data Write	6-15
time setting.....	3-4

timechart..... 3-13
transfer protocol..... 5-3
troubleshooting 10-2
type codes, variable types 6-7

U

unit number..... 5-5

V

variable area parameters and
setting/monitor ranges, CompoWay/F 7-2

variable area parameters and
setting/monitor ranges, Modbus..... 9-2
variable areas, Modbus..... 9-2

W

Write to Variable Area, CompoWay/F ... 6-10
Write to Variable Area, Modbus 8-10

Z

zero shift 1-2, 4-13

OMRON Corporation
Industrial Automation Company
Control Devices Division H.Q.
Strategy Planning Division

Shiokoji Horikawa, Shimogyo-ku,
Kyoto, 600-8530 Japan
Tel: (81) 75-344-7109/Fax: (81) 75-344-7149

Regional Headquarters

OMRON EUROPE B.V.
Wegalaan 67-69-2132 JD Hoofddorp
The Netherlands
Tel: (31)2356-81-300/Fax: (31)2356-81-388

OMRON Industrial Automation Global: www.ia.omron.com

OMRON ELECTRONICS LLC
One Commerce Drive Schaumburg,
IL 60173-5302 U.S.A.
Tel: (1) 847-843-7900/Fax: (1) 847-843-7787

OMRON ASIA PACIFIC PTE. LTD.
No. 438A Alexandra Road # 05-05/08 (Lobby 2),
Alexandra Technopark, Singapore 119967
Tel: (65) 6835-3011/Fax: (65) 6835-2711

OMRON (CHINA) CO., LTD.
Room 2211, Bank of China Tower,
200 Yin Cheng Zhong Road,
PuDong New Area, Shanghai, 200120, China
Tel: (86) 21-5037-2222/Fax: (86) 21-5037-2200

Authorized Distributor:

© OMRON Corporation 2009 All Rights Reserved.
In the interest of product improvement,
specifications are subject to change without notice.

Cat. No. H161-E1-02

Printed in Japan
1009