

New Super MK Relays. Models with Latching Lever Added to the Series.

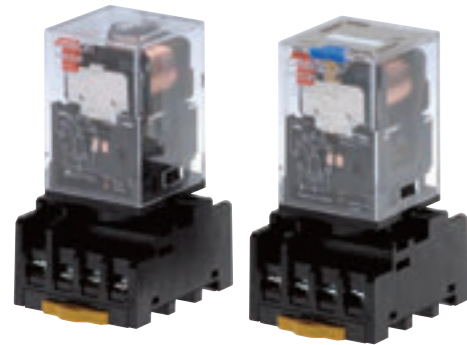

- Same mounting and internal wiring as the previous Super MK Relays
- Built-in mechanical indicator enables checking contact operation.
- Two modes can be used to check circuits for models with latching lever.
- Nameplate provided on models with latching lever.
- All materials are RoHS compliant.
- UL and IEC (TÜV) certification.



For the most recent information on models that have been certified for safety standards, refer to your OMRON website.

Features

Models with Latching Lever

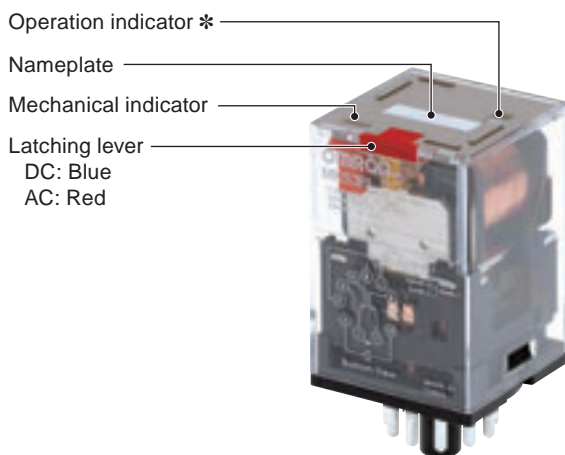

* The operation indicator is built in only on specified models.

Example of Applications of Models with Latching Levers

Operation checks in relay sequence circuits

Operating Method for Latching Lever

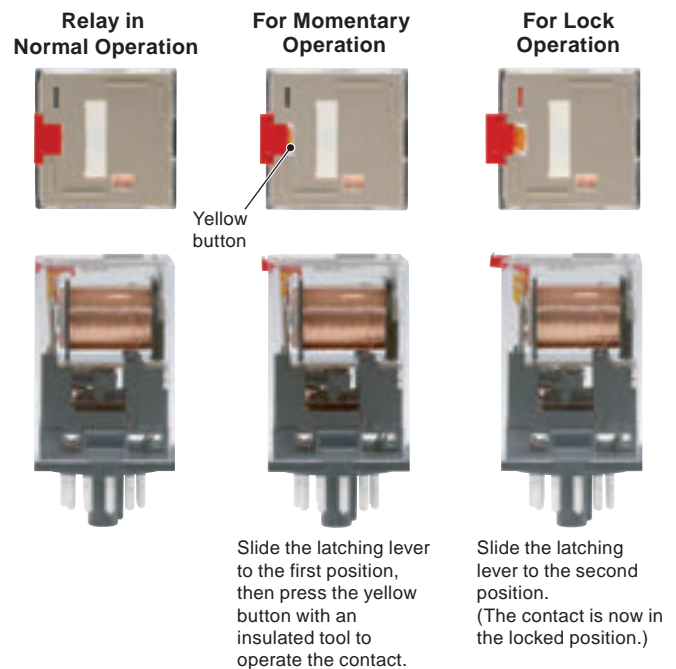

Model Number Structure

Model Number Legend

MKS□□□□□-□-□
1 2 3 4 5 6 7

1. Contact Form

- 2: DPDT
- 3: 3PDT

2. Terminals

P: Plug-in

3. Mechanical Indicator/Test Button

- Blank: Mechanical indicator
- I: Mechanical indicator and lockable test button

4. LED Indicator

- Blank: Standard
- N: LED indicator

5. Coil Polarity

- Blank: Standard
- 1: Reverse polarity (DC coil only)

6. Surge Absorption

- Blank: Standard
- D: Surge absorber diode (DC coil only)
- V: Surge absorber varistor (AC coil only)

7. Internal Connections

- Blank: Standard
- 2 or 5: Non-standard connections (Refer to "Terminal Arrangement and Internal Connection (Bottom View)".)

8. Rated Voltage

(Refer to "Coil Ratings".)

Ordering Information

When your order, specify the rated voltage.

List of Models

Type	Terminals	Contact form	Internal connections (See note 3.)	With mechanical indicator	With mechanical indicator and lockable test button	Coil ratings
Standard Models	Plug-in	DPDT	Standard	MKS2P	MKS2PI	AC/DC
			Non-standard	MKS2P-2	MKS2PI-2	
		3PDT	Standard	MKS3P	MKS3PI	
			Non-Standard	MKS3P-2 MKS3P-5	MKS3PI-2 MKS3PI-5	
Models with LED Indicator (See note 2.)		DPDT	Standard	MKS2PN(1)	MKS2PIN(1)	AC/DC
			Non-standard	MKS2PN(1)-2	MKS2PIN(1)-2	
		3PDT	Standard	MKS3PN(1)	MKS3PIN(1)	
			Non-Standard	MKS3PN(1)-2 MKS3PN(1)-5	MKS3PIN(1)-2 MKS3PIN(1)-5	
Models with Diode (See note 2.)	DPDT	Standard	MKS2P(1)-D	MKS2PI(1)-D	DC	
		Non-standard	MKS2P(1)-D-2	MKS2PI(1)-D-2		
	3PDT	Standard	MKS3P(1)-D	MKS3PI(1)-D		
		Non-Standard	MKS3P(1)-D-2 MKS3P(1)-D-5	MKS3PI(1)-D-2 MKS3PI(1)-D-5		
Models with LED Indicator and Diode	DPDT	Standard	MKS2PN-D	MKS2PIN-D	DC	
		Non-standard	MKS2PN-D-2	MKS2PIN-D-2		
	3PDT	Standard	MKS3PN-D	MKS3PIN-D		
		Non-Standard	MKS3PN-D-2 MKS3PN-D-5	MKS3PIN-D-2 MKS3PIN-D-5		
Models with Varistor	DPDT	Standard	MKS2P-V	MKS2PI-V	AC	
		Non-standard	MKS2P-V-2	MKS2PI-V-2		
	3PDT	Standard	MKS3P-V	MKS3PI-V		
		Non-Standard	MKS3P-V-2 MKS3P-V-5	MKS3PI-V-2 MKS3PI-V-5		
Models with LED Indicator and Varistor	DPDT	Standard	MKS2PN-V	MKS2PIN-V	AC	
		Non-standard	MKS2PN-V-2	MKS2PIN-V-2		
	3PDT	Standard	MKS3PN-V	MKS3PIN-V		
		Non-Standard	MKS3PN-V-2 MKS3PN-V-5	MKS3PIN-V-2 MKS3PIN-V-5		

Note: 1. When ordering, add the rated voltage to the model number. Rated voltages are given in the coil ratings table in the specifications.

Example: MKS3P 24 VDC

Rated voltage

2. The DC coil comes in two types: standard coil polarity and reverse coil polarity.

Refer to *Terminal Arrangement and Internal Connections (Bottom View)*.

Example: MKS2PIN1-2 24 VDC

Reverse coil polarity

3. Refer to *Terminal Arrangement and Internal Connections (Bottom View)* for non-standard internal connections.

List of Models (Order Separately)

Item	Type	Model
Track-mounted Socket	8-pin	PF083A-E
	11-pin	PF113A-E
	8-pin	PF083A-D
	11-pin	PF113A-D
Hold-down Clip (For PF083A-E and PF113A-E)		PFC-A1

Specifications

Ratings

Coil Ratings

Rated voltage	Rated current		Coil resistance	Must operate voltage	Must release voltage	Max. voltage	Power consumption
	50 Hz	60 Hz					
AC	6 V	443 mA	385 mA	3.1 Ω	80% max. of rated voltage	110% of rated voltage	Approx. 2.3 VA at 60 Hz Approx. 2.7 VA at 50 Hz
	12 V	221 mA	193 mA	13.7 Ω			
	24 V	110 mA	96.3 mA	48.4 Ω			
	100 V	26.6 mA	23.1 mA	760 Ω			
	110 V	24.2 mA	21.0 mA	932 Ω			
	200 V	13.3 mA	11.6 mA	3,160 Ω			
	220 V	12.1 mA	10.5 mA	3,550 Ω			
	230 V	10.0 mA	11.5 mA	4,250 Ω			
	240 V	11.0 mA	9.6 mA	4,480 Ω			
DC	6 V	224 mA		26.7 Ω	15% min. of rated voltage	Approx. 1.4 W	
	12 V	112 mA		107 Ω			
	24 V	55.8 mA		430 Ω			
	48 V	28.1 mA		1,710 Ω			
	100 V	13.5 mA		7,390 Ω			
	110 V	12.3 mA		8,960 Ω			
	125 V	10.8 mA		11,576 Ω			

- Note:**
1. The rated current and coil resistance are measured at a coil temperature of 23°C with tolerances of +15%/–20% for AC rated current and ±15% for DC coil resistance.
 2. Performance characteristic data are measured at a coil temperature of 23°C.
 3. The maximum voltage is one that is applicable instantaneously to the Relay coil at 23°C and not continuously.
 4. For DC-operated Relays with the LED indicator built-in, add an LED current of approx. 5 mA to the rated current.

Contact Ratings

Load		Resistive load ($\cos\phi = 1$)	Inductive load ($\cos\phi = 0.4$)
Contact mechanism		Single	
Contact material		AgSnIn	
Rated load	NO	10 A, 250 VAC 10A, 30 VDC	7 A, 250 VAC
	NC	5 A, 250 VAC 5 A, 30 VDC	
Rated carry current		10 A	
Max. switching voltage		250 VAC, 250 VDC	
Max. switching current		10 A	
Max. switching power	NO	2,500 VAC 300 WDC	1,750 VAC
	NC	1,250 VAC 150 WDC	

Characteristics

Contact resistance	100 mΩ max.
Operate time	AC: 20 ms max. DC: 30 ms max.
Release time	20 ms max. (40 ms max. for built-in Diode Relays)
Max. operating frequency	Mechanical: 18,000 operations/h Electrical: 1,800 operations/h (under rated load)
Insulation resistance	100 MΩ min. (at 500 VDC)
Dielectric strength	2,500 VAC 50/60 Hz for 1 min between coil and contacts 1,000 VAC 50/60 Hz for 1 min between contacts of same polarity and terminals of the same polarity 2,500 VAC 50/60 Hz for 1 min between current-carrying parts, non-current-carrying parts, and opposite polarity
Insulation method	Basic insulation
Impulse withstand voltage	4.5 kV between coil and contacts (with 1.2 × 50 μs impulse wave) 3.0 kV between contacts of different polarity (with 1.2 × 50 μs impulse wave)
Pollution degree	3
Rated insulation voltage	250 V
Vibration resistance	Destruction: 10 to 55 to 10 Hz, 0.75-mm single amplitude (1.5-mm double amplitude) Malfunction: 10 to 55 to 10 Hz, 0.5-mm single amplitude (1.0-mm double amplitude)
Shock resistance	Destruction: 1,000 m/s ² (approx. 100 G) Malfunction: 100 m/s ² (approx. 10 G)
Endurance	Mechanical: 5,000,000 operations min. (at 18,000 operations/h under rated load) Electrical: 100,000 operations h. (at 1,800 operations/h under rated load)
Failure rate P level (reference value)	10 mA at 1 VDC
Ambient temperature	Operating: -40 to 60°C (with no icing or condensation)
Ambient humidity	Operating: 5% to 85%
Weight	Approx. 90 g

Note: 1. The values given above are initial values.
2. P level: $\lambda_{60} = 0.1 \times 10^{-6}$ /operation
3. Ambient temperature of models with LED indicator is -25 to 60°C.

Approved Standards

UL508 (File No. E41515) 

Coil ratings	Contact ratings	Operations
6 to 110 VDC 6 to 240 VAC	N.O. contact 10 A, 250 V AC 50/60 Hz (Resistive) 10 A, 30 V DC (Resistive) 7 A, 250 V AC 50/60 Hz (General Use)	100,000
	N.C. contact 10 A, 250 V AC 50/60 Hz (Resistive) 10 A, 30 V DC (Resistive) 7 A, 250 V AC 50/60 Hz (General Use)	100,000

CSA Standard: CSA C22.2 No. 14 (File No. LR35535) 

Coil ratings	Number of Poles	Contact ratings	Operations
6 to 125 VDC 6 to 240 VAC	2	10 A, 250 V AC (Resistive) 10 A, 30 V DC (Resistive) 7 A, 250 V AC (General Use)	100,000
	3	10 A, 250 V AC (Resistive) Same Polarity 10 A, 30 V DC (Resistive) Same Polarity 7 A, 250 V AC (General Use) Same Polarity	100,000

IEC Standard/TÜV Certification: IEC61810-1
(Certification No. R50104853) 

Coil ratings	Contact ratings	Operations
6, 12, 24, 48, 100, 110 VDC 6, 12, 24, 100, 110, 200, 220, 240 VAC	N.O. contact 10 A, 250 V AC 50/60 Hz (Resistive) 10 A, 30 V DC (Resistive) 7 A, 250 V AC 50/60 Hz (General Use)	100,000
	N.C. contact 5 A, 250 V AC 50/60 Hz (Resistive) 5 A, 30 V DC (Resistive) 7 A, 250 V AC 50/60 Hz (General Use)	100,000

Note: When Relays are mounted on the PF083A-E or PF113A-E, the maximum carrying current is 9 A.

Engineering Data

Reference Data

Maximum Switching Power

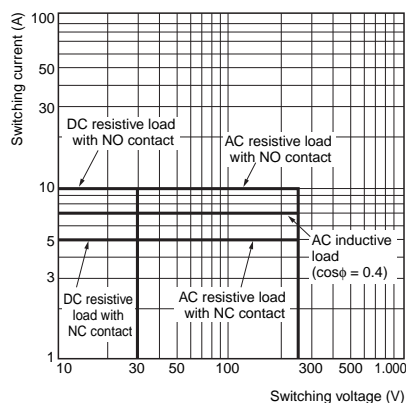

Rated Carry Current vs. Ambient Rated Temperature

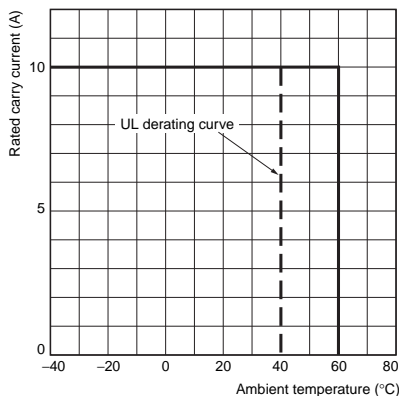

Note: The lower limit of the ambient operating temperature for models with built-in operation indicators is -25°C.

Dimensions

Models without Latching Lever

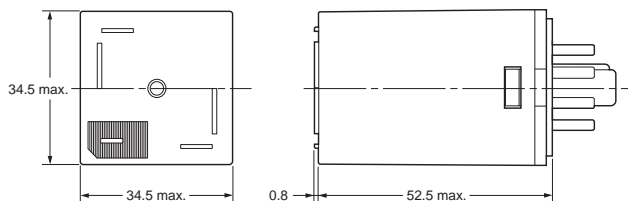



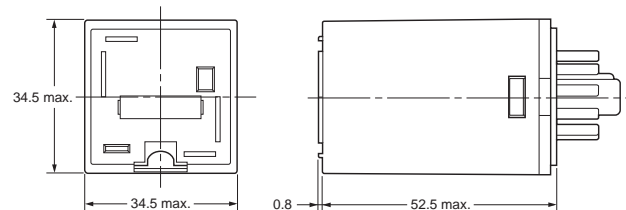



Models with Latching Lever



Sockets

See below for Socket dimensions.

Socket	Surface-mounting Socket (for track or screw mounting)		
	Finger-protection models		---
Maximum carry current	10 A		5 A
2 poles	PF083A-E 	PF083A-D 	PF083A 
3 poles	PF113A-E 	PF113A-E-D 	PF113A 

Note: Use the Surface-mounting Sockets (i.e., finger-protection models) with “E” at the end of the model number. When using the PF083A and PF113A, be sure not to exceed the Socket’s maximum carry current of 5 A. Using at a current exceeding 5 A may lead to burning. Round terminals cannot be used for finger-protection models. Use Y-shaped terminals.

PF083A-E (Conforming to EN 50022)

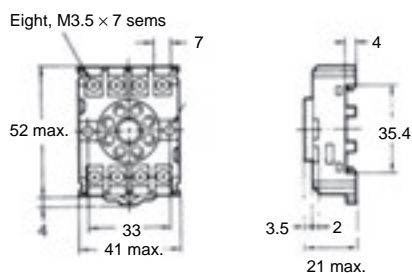

Terminal Arrangement

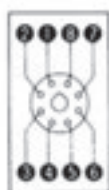

Mounting Holes

Two, M4 or two 4.5-dia. holes

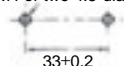

PF113A-E (Conforming to EN 50022)

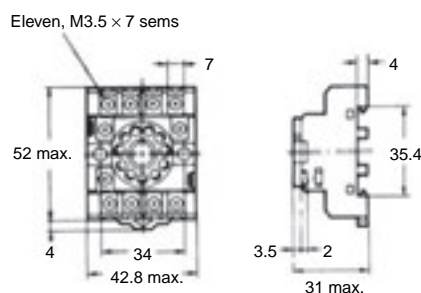

Terminal Arrangement



Mounting Holes

Two, M4 or two 4.5-dia. holes

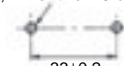

PF083A-D

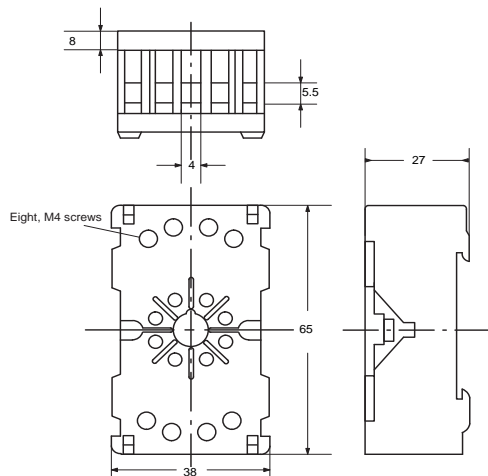

Terminal Arrangement

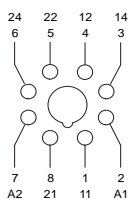

Mounting Holes

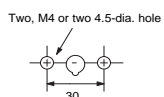

PF113A-D

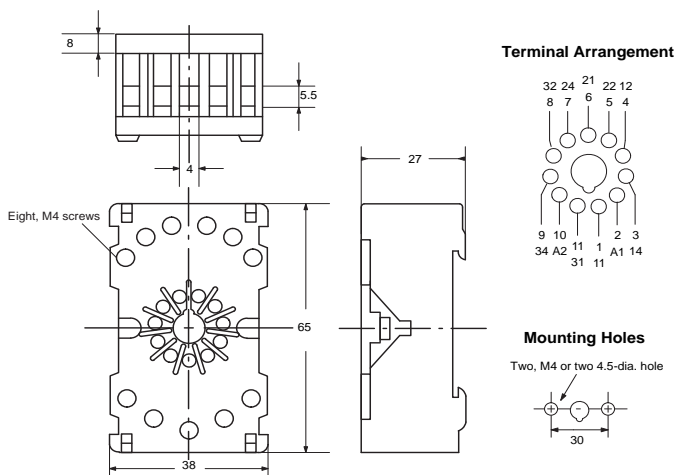

Terminal Arrangement

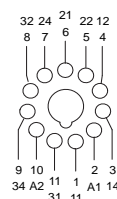

Mounting Holes

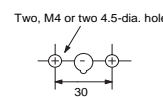

Hold-down Clips

PFC-A1

(2 pieces per set)

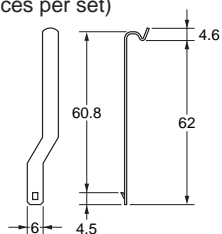

Mounting Tracks

**PFP-100N, PFP-50N
(Conforming to EN 50022)**

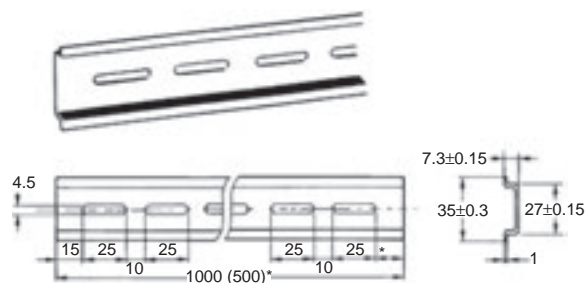

* This dimension applies to the PFP-50N Mounting Track.

**PFP-100N2
(Conforming to EN 50022)**

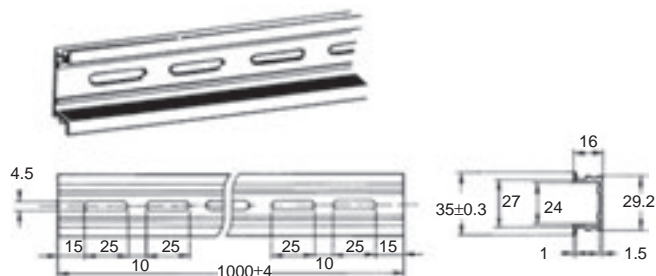

* A total of twelve 25 × 4.5 elliptic holes is provided with six holes cut from each track end at a pitch of 10 mm.

Mounting Height with Sockets

Surface-mounting Sockets

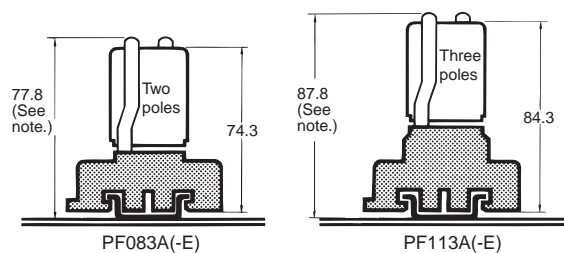

Note: PF083A(-E) and PF113A(-E) allow either track or screw mounting.

Terminal Arrangement and Internal Connection (Bottom View)

Standard Models
(AC/DC Coil)

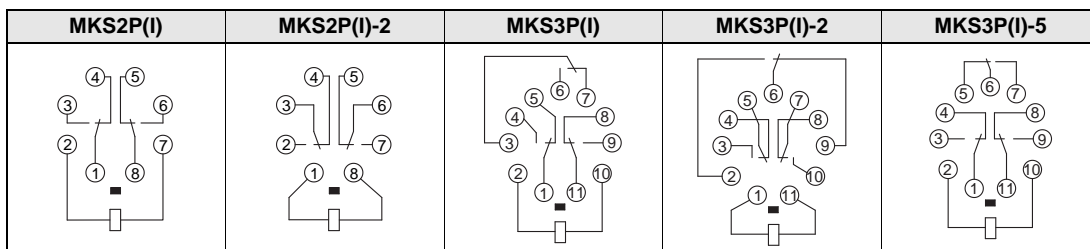

Models with
LED Indicator
(AC Coil)

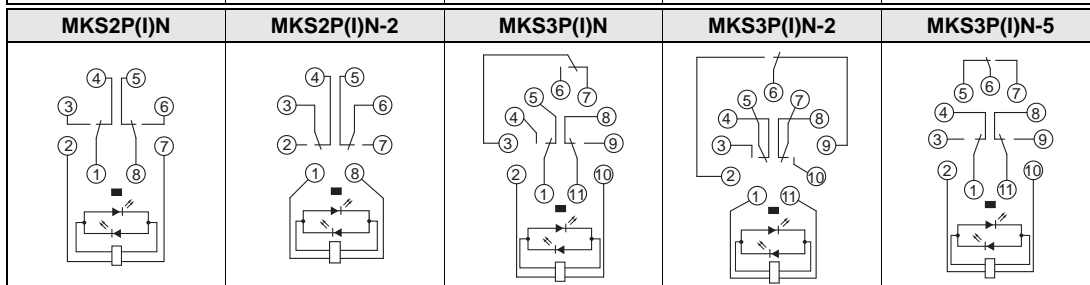

Models with Diode
(DC Coil:
Standard Polarity)

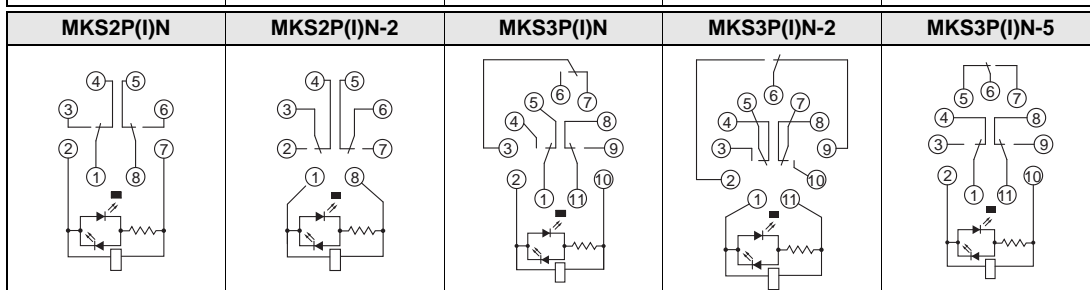

Models with
LED Indicator and Diode
(DC Coil:
Reverse Polarity)

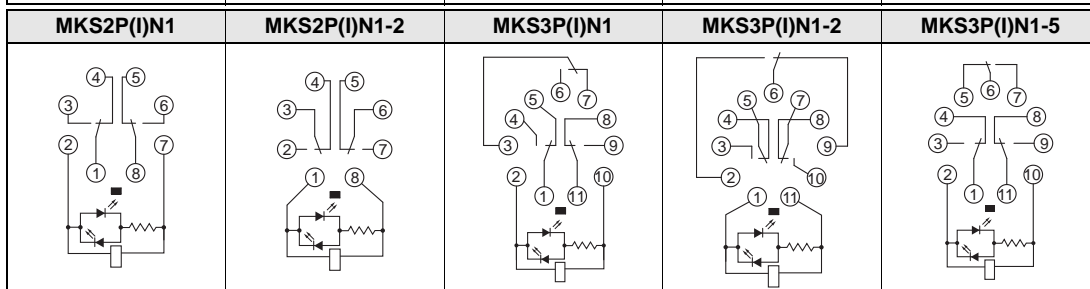

Standard Models
(DC Coil:
Standard Polarity)

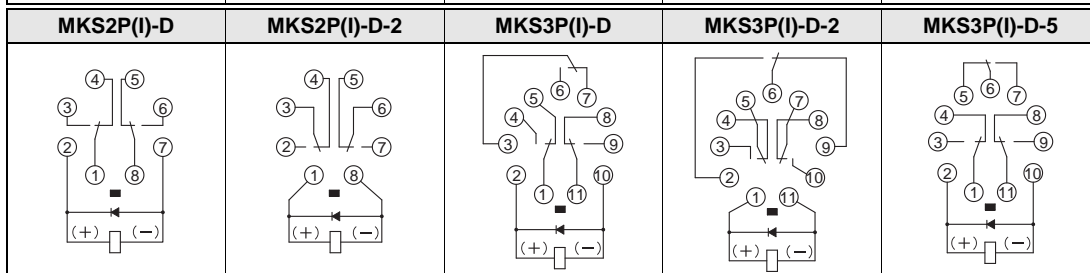

Models with Diode
(DC Coil:
Reverse Polarity)

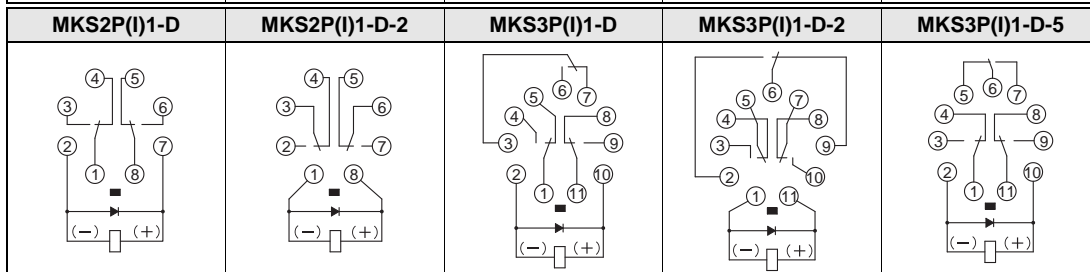

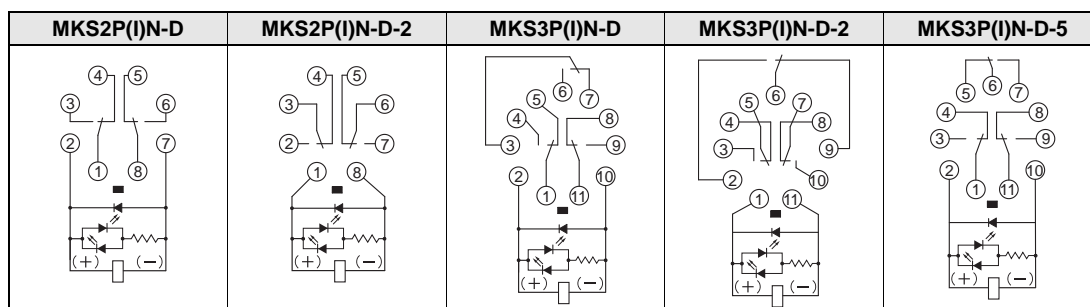
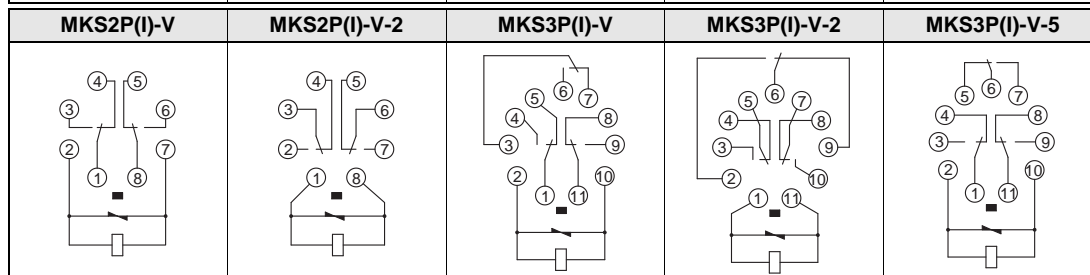
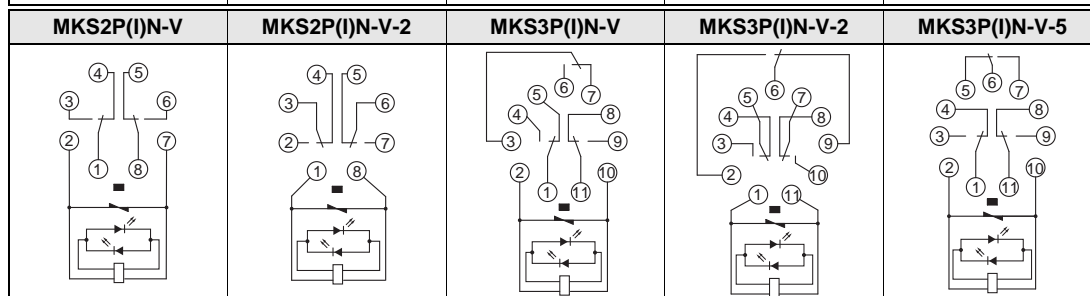
**Models with
LED indicator
(DC Coil)**

**Models with Varistor
(AC Coil)**

**Models with
LED indicator and
Varistor
(AC Coil)**

Safety Precautions

Refer to *Safety Precautions for All Relays*.

Safety Precautions for Correct Use

Installation

Mount the MK-S with the marking at the bottom.

Handling

Check the coil polarity of models with built-in operation indicator (DC operation coil) and wire them correctly .

Test Button

Do not use the test button for any purpose other than testing. Be sure not to touch the test button accidentally as this will turn the contacts ON.

Before using the test button, confirm that circuits, the load, and any other connected item will operate safely.

Check that the test button is released before turning ON relay circuits.

If the test button is pulled out too forcefully, it may bypass the momentary testing position and go straight into the locked position.

Use an insulated tool when you operate the test button.

Models with test buttons or LED indicators fulfill the requirements for reinforced insulation between live parts and the front of cover only when the Relay is in a complete condition, i.e. with the nameplate, nameplate frame, test button, and slider in place. If any of these parts are removed, only the requirements for basic insulation are fulfilled.

Terms and Conditions Agreement

Read and understand this catalog.

Please read and understand this catalog before purchasing the products. Please consult your OMRON representative if you have any questions or comments.

Warranties.

(a) Exclusive Warranty. Omron's exclusive warranty is that the Products will be free from defects in materials and workmanship for a period of twelve months from the date of sale by Omron (or such other period expressed in writing by Omron). Omron disclaims all other warranties, express or implied.

(b) Limitations. OMRON MAKES NO WARRANTY OR REPRESENTATION, EXPRESS OR IMPLIED, ABOUT NON-INFRINGEMENT, MERCHANTABILITY OR FITNESS FOR A PARTICULAR PURPOSE OF THE PRODUCTS. BUYER ACKNOWLEDGES THAT IT ALONE HAS DETERMINED THAT THE PRODUCTS WILL SUITABLY MEET THE REQUIREMENTS OF THEIR INTENDED USE.

Omron further disclaims all warranties and responsibility of any type for claims or expenses based on infringement by the Products or otherwise of any intellectual property right. (c) Buyer Remedy. Omron's sole obligation hereunder shall be, at Omron's election, to (i) replace (in the form originally shipped with Buyer responsible for labor charges for removal or replacement thereof) the non-complying Product, (ii) repair the non-complying Product, or (iii) repay or credit Buyer an amount equal to the purchase price of the non-complying Product; provided that in no event shall Omron be responsible for warranty, repair, indemnity or any other claims or expenses regarding the Products unless Omron's analysis confirms that the Products were properly handled, stored, installed and maintained and not subject to contamination, abuse, misuse or inappropriate modification. Return of any Products by Buyer must be approved in writing by Omron before shipment. Omron Companies shall not be liable for the suitability or unsuitability or the results from the use of Products in combination with any electrical or electronic components, circuits, system assemblies or any other materials or substances or environments. Any advice, recommendations or information given orally or in writing, are not to be construed as an amendment or addition to the above warranty.

See <http://www.omron.com/global/> or contact your Omron representative for published information.

Limitation on Liability: Etc.

OMRON COMPANIES SHALL NOT BE LIABLE FOR SPECIAL, INDIRECT, INCIDENTAL, OR CONSEQUENTIAL DAMAGES, LOSS OF PROFITS OR PRODUCTION OR COMMERCIAL LOSS IN ANY WAY CONNECTED WITH THE PRODUCTS, WHETHER SUCH CLAIM IS BASED IN CONTRACT, WARRANTY, NEGLIGENCE OR STRICT LIABILITY.

Further, in no event shall liability of Omron Companies exceed the individual price of the Product on which liability is asserted.

Suitability of Use.

Omron Companies shall not be responsible for conformity with any standards, codes or regulations which apply to the combination of the Product in the Buyer's application or use of the Product. At Buyer's request, Omron will provide applicable third party certification documents identifying ratings and limitations of use which apply to the Product. This information by itself is not sufficient for a complete determination of the suitability of the Product in combination with the end product, machine, system, or other application or use. Buyer shall be solely responsible for determining appropriateness of the particular Product with respect to Buyer's application, product or system. Buyer shall take application responsibility in all cases.

NEVER USE THE PRODUCT FOR AN APPLICATION INVOLVING SERIOUS RISK TO LIFE OR PROPERTY OR IN LARGE QUANTITIES WITHOUT ENSURING THAT THE SYSTEM AS A WHOLE HAS BEEN DESIGNED TO ADDRESS THE RISKS, AND THAT THE OMRON PRODUCT(S) IS PROPERLY RATED AND INSTALLED FOR THE INTENDED USE WITHIN THE OVERALL EQUIPMENT OR SYSTEM.

Programmable Products.

Omron Companies shall not be responsible for the user's programming of a programmable Product, or any consequence thereof.

Performance Data.

Data presented in Omron Company websites, catalogs and other materials is provided as a guide for the user in determining suitability and does not constitute a warranty. It may represent the result of Omron's test conditions, and the user must correlate it to actual application requirements. Actual performance is subject to the Omron's Warranty and Limitations of Liability.

Change in Specifications.

Product specifications and accessories may be changed at any time based on improvements and other reasons. It is our practice to change part numbers when published ratings or features are changed, or when significant construction changes are made. However, some specifications of the Product may be changed without any notice. When in doubt, special part numbers may be assigned to fix or establish key specifications for your application. Please consult with your Omron's representative at any time to confirm actual specifications of purchased Product.

Errors and Omissions.

Information presented by Omron Companies has been checked and is believed to be accurate; however, no responsibility is assumed for clerical, typographical or proofreading errors or omissions.

2024.1

In the interest of product improvement, specifications are subject to change without notice.

OMRON Corporation
Industrial Automation Company

<http://www.ia.omron.com/>

(c)Copyright OMRON Corporation 2024 All Right Reserved.